

High Performance Inverter

FRENIC-Ace

Global model User's Manual

CAUTION

Thank you for purchasing our multifunction FRENIC-Ace series of inverters.

- Be sure to set the destination on inverter type FRN****E2S/E2E-2G□/4G□/7G□ for the initial power supply. Without setting the destination, the inverter cannot be operated. For details, refer to 4.4 Destination setting.
- This product is designed to drive a three-phase motor under variable speed control. Read through this user's manual and become familiar with the handling procedure for correct use.
- Improper handling might result in incorrect operation, a short life, or even a failure of this product as well as the motor.
- Deliver this manual to the end user of this product. Keep this manual in a safe place until this product is discarded.
- For how to use an optional device, refer to the instruction and installation manuals for that optional device.

Copyright © 2014 Fuji Electric Co., Ltd.

All rights reserved.

No part of this publication may be reproduced or copied without prior written permission from Fuji Electric Co., Ltd.

All products and company names mentioned in this manual are trademarks or registered trademarks of their respective holders.

The information contained herein is subject to change without prior notice for improvement.

The purpose of this user's manual is to provide accurate information in handling, setting up and operating of the FRENIC-Ace series of inverters. Please feel free to send your comments regarding any errors or omissions you may have found, or any suggestions you may have for generally improving the manual.

In no event will Fuji Electric Co., Ltd. be liable for any direct or indirect damages resulting from the application of the information in this manual.

Preface

Thank you for purchasing our multifunction FRENIC-Ace series of inverters. This product is designed to drive a three-phase induction motor or a three-phase permanent magnet synchronous motor under variable speed control.

This manual provides all the information on the FRENIC-Ace (Global model) series of inverters including its operating procedure and selection of peripheral equipment. Before use, carefully read this manual for proper use. Improper handling might result in incorrect operation, a short life, or even a failure of this product as well as the motor.

The table below lists the other materials related to the use of the FRENIC-Ace. Read them in conjunction with this manual if necessary.

Name	Material No.	Description
Catalog	24A1-E-0042	Product scope, features, specifications, external drawings, and options of the product
RS-485 Communication User's Manual	24A7-E-0021*	Overview of functions implemented by using FRENIC-Ace RS-485 communications facility, its communications specifications, Modbus RTU/Fuji general-purpose inverter protocol, function codes and related data formats
User's Manual for China model.	24A7-C-0043	This manual is written in simplified Chinese.
User's Manual for Japanese model.	24A7-J-0088	This manual is written in Japanese.

*Available soon

The materials are subject to change without notice. Be sure to obtain the latest editions for use.

How this manual is organized

This manual contains Chapters 1 through 13 and Appendices.

Chapter 1 BEFORE USE

This chapter describes the items to be checked before the use of the inverter.

Chapter 2 INSTALLATION AND WIRING

This chapter describes the important points in installing and wiring inverters.

Chapter 3 OPERATION USING THE KEYPAD

This chapter describes keypad operation of the inverter.

Chapter 4 TEST RUN PROCEDURE

This chapter describes basic settings required for making a test run.

Chapter 5 FUNCTION CODE

This chapter explains the table of function codes used in FRENIC-Ace, and the detail of each function code.

Chapter 6 TROUBLESHOOTING

This chapter describes troubleshooting procedures to be followed when the inverter malfunctions or detects an alarm or a light alarm condition. In this chapter, first check whether any alarm code or the "light alarm" indication ($L-AL$) is displayed or not, and then proceed to the troubleshooting items.

Chapter 7 MAINTENANCE AND INSPECTION

This chapter describes the maintenance and inspection items of the inverter.

Chapter 8 BLOCK DIAGRAMS FOR CONTROL LOGIC

This chapter describes the main block diagrams of the control section.

Chapter 9 COMMUNICATION FUNCTIONS

This chapter describes an overview of inverter operation through the RS-485 and CANopen communications. For details of RS-485 communication, refer to the RS-485 Communication User's Manual (24A7-E-0021).

Chapter 10 SELECTING OPTIMAL MOTOR AND INVERTER CAPACITIES

This chapter provides you with information about the inverter output torque characteristics, selection procedure, and equations for calculating capacities to help you select optimal motor and inverter models. It also helps you select braking resistors, inverter mode (ND, HD, HND, or HHD), and motor drive control.

Chapter 11 SELECTING Peripheral EQUIPMENT

This chapter describes how to use a range of peripheral equipment and options, FRENIC-Ace's configuration with them, and requirements and precautions for selecting wires and crimp terminals.

Chapter 12 SPECIFICATIONS

This chapter describes the output ratings, input power, basic functions and other specifications of the FRENIC-Ace standard model.

Chapter 13 EXTERNAL DIMENSIONS

This chapter gives external dimensions of the inverter.

APPENDICES

CONTENTS

Chapter 1 BEFORE USE

1.1	Acceptance Inspection (Nameplates and Inverter Type)	1-1
1.2	External View and Terminal Blocks	1-3
1.3	Precautions for Using Inverters	1-5
1.3.1	Usage environment	1-5
1.3.2	Storage environment	1-7
[1]	Temporary storage	1-7
[2]	Long-term storage	1-7
1.3.3	Precautions for connection of peripheral equipment	1-8
[1]	Phase-advancing capacitors for power factor correction	1-8
[2]	Power supply lines (Application of a DC/AC reactor)	1-8
[3]	DC reactor (DCR) for correcting the inverter input power factor (for suppressing harmonics)	1-8
[4]	PWM converter for correcting the inverter input power factor	1-8
[5]	Molded case circuit breaker (MCCB) / residual-current-operated protective device (RCD) / earth leakage circuit breaker (ELCB)	1-9
[6]	Magnetic contactor (MC) in the inverter input (primary) circuit	1-9
[7]	Magnetic contactor (MC) in the inverter output (secondary) circuit	1-9
[8]	Surge absorber/surge killer	1-9
1.3.4	Noise reduction	1-10
1.3.5	Leakage current	1-10
1.3.6	Precautions in driving a permanent magnet synchronous motor (PMSM)	1-10

Chapter 2 INSTALLATION AND WIRING

2.1	Installation	2-1
2.2	Wiring	2-3
2.2.1	Basic connection diagram	2-3
2.2.2	Removal and attachment of the front cover/ terminal cover and wiring guide	2-6
2.2.3	Precautions for wiring	2-8
2.2.4	Precautions for long wiring (between inverter and motor)	2-10
2.2.5	Main circuit terminals	2-12
[1]	Screw specifications	2-12
[2]	Terminal layout diagram (main circuit terminal)	2-15
[3]	Recommended wire size (main circuit terminals)	2-17
[4]	Description of terminal functions (main circuit terminal)	2-38
2.2.6	Control circuit terminals (common to all models)	2-42
[1]	Screw specifications and recommended wire size (control circuit terminals)	2-42
[2]	Terminal layout diagram (control circuit terminal)	2-42
[3]	Description of terminal functions (control circuit terminal)	2-43
2.2.7	Switching connector (types FRN0203E2■-4□ or above)	2-51
2.2.8	Operating slide switches	2-53
2.3	Attachment and Connection of Keypad	2-55
2.3.1	Parts required for connection	2-55
2.3.2	Attachment procedure	2-55
2.4	RJ-45 Cover	2-59

Chapter 3 OPERATION USING THE KEYPAD

3.1	Names and Functions of Keypad Components	3-1
3.2	Overview of Operation Modes	3-3
3.3	Running Mode	3-5
3.3.1	Monitoring the running status	3-5
3.3.2	Monitoring light alarms	3-7



3.3.3	Running or stopping the motor	3-8
3.3.4	Setting up reference frequency from the keypad	3-9
3.3.5	Setting up PID commands from the keypad	3-10
[1]	Settings under PID process control	3-10
[2]	Settings under PID dancer control	3-12
3.3.6	Jogging operation	3-14
3.3.7	Remote and local modes	3-15
3.4	Programming Mode	3-16
3.4.1	Setting up function codes "Data Setting: <i>1F__</i> through <i>1D__</i> "	3-17
3.4.2	Checking changed function codes "Data Checking: <i>2REP</i> "	3-18
3.4.3	Monitoring the running status "Drive Monitoring: <i>3DPE</i> "	3-19
3.4.4	Checking I/O signal status "I/O Checking: <i>4IOD</i> "	3-23
3.4.5	Reading maintenance information "Maintenance Information: <i>5LHE</i> "	3-27
3.4.6	Reading alarm information "Alarm Information: <i>6AL</i> "	3-31
3.4.7	Copying data "Data Copying: <i>7CPY</i> "	3-34
3.4.8	Setting up basic function codes quickly "Quick Setup: <i>0Frc</i> "	3-38
3.5	Alarm Mode	3-40
3.5.1	Releasing the alarm and switching to Running mode	3-40
3.5.2	Displaying the alarm history	3-40
3.5.3	Displaying the status of inverter at the time of alarm	3-40
3.5.4	Switching to Programming mode	3-40

Chapter 4 TEST RUN PROCEDURE

4.1	Test Run Procedure Flowchart	4-1
4.2	Checking Prior to Powering On	4-2
4.3	Powering ON and Checking	4-3
4.4	Destination setting	4-4
4.5	Switching the Applicable Motor Rating (ND, HD, HND and HHD Modes)	4-6
4.6	Selecting a Desired Motor Drive Control	4-8
4.6.1	V/f control with slip compensation inactive for IM	4-8
4.6.2	Vector control without speed sensor (Dynamic torque vector) for IM	4-8
4.6.3	V/f control with slip compensation active for IM	4-9
4.6.4	V/f Control with speed sensor for IM	4-9
4.6.5	V/f Control with speed sensor with Auto Torque Boost for IM	4-9
4.6.6	Vector Control with speed sensor for IM	4-9
4.6.7	Vector Control without speed sensor and magnetic pole position sensor for PMSM	4-10
4.7	Performance Comparison for Drive Controls (Summary)	4-11
4.8	Configuring Function Codes for Drive Controls	4-12
4.8.1	Driving an Induction Motor (IM)	4-13
[1]	Driving a non-Fuji motor or Fuji non-standard IM under the V/f control	4-13
[2]	Driving a Fuji general-purpose IM under the V/f control	4-14
[3]	Driving an IM under the V/f control with speed sensor	4-15
[4]	Driving a non-Fuji motor or Fuji non-dedicated IM under vector control with/without speed sensor	4-16
[5]	Driving a Fuji dedicated IM (MVK series) under vector control with speed sensor	4-20
4.8.2	Driving a permanent magnet synchronous motor (PMSM) without pole sensor and magnetic pole position sensor	4-21
[1]	Driving a non-Fuji PMSM	4-21
[2]	Driving a Fuji dedicated PMSM (GNB2 series)	4-26
[3]	Driving a Fuji non-dedicated PMSM (non-GNB2 series)	4-26
4.9	Running the Inverter for Motor Operation Check	4-27
4.9.1	Test run procedure	4-27
4.9.2	Check points during a test run	4-27
4.9.3	Modification of motor control function code data	4-28

4.10	Selecting a Frequency Command Source	4-30
4.10.1	Setting up a frequency command from the keypad	4-30
4.10.2	Setting up a frequency command with an external potentiometer	4-30
4.10.3	Setting up a frequency command with multistep frequency selection	4-31
4.11	Selecting a Run Command Source	4-32
4.11.1	Setting up a run command from the keypad	4-32
4.11.2	Setting up a run command with digital input signals (terminals [FWD] and [REV])	4-32

Chapter 5 FUNCTION CODES

5.1	Function Codes Overview	5-1
5.2	Function Codes Table	5-2
5.2.1	Supplementary note	5-2
5.2.2	Function codes table	5-4
5.2.3	Factory default value per applicable electric motor capacitance	5-36
5.2.4	Motor constants	5-37
[1]	When Fuji standard motor 8-series, or other motors are selected by motor selection (Function code P99/ A39 = 0 or 4)	5-37
[2]	When HP rating motor is selected by motor selection (Function code P99/A39 = 1)	5-41
5.3	Description of Function Codes	5-45
5.3.1	F codes (Basic functions)	5-45
[1]	Frequency setting by keypad (F01 = 0 (Factory default state), 8)	5-47
[2]	Setting up a reference frequency using analog input (F01 = 1 to 3, 5)	5-48
[3]	Frequency setting by digital input signal "UP"/"DOWN" (F01=7)	5-54
[4]	Frequency setting using digital inputs (option DIO interface card) (F01 = 11)	5-55
[5]	Frequency setting using pulse train input (F01 = 12)	5-55
5.3.2	E codes (Extension terminal functions)	5-100
5.3.3	C codes (Control functions)	5-139
5.3.4	P codes (Motor 1 parameters)	5-148
5.3.5	H codes (High performance functions)	5-155
[1]	Measuring the capacitance of DC link bus capacitor in comparison with initial one at shipment	5-171
[2]	Measuring the capacitance of DC link bus capacitor under ordinary operating conditions at power shutdown	5-172
5.3.6	A codes (Motor 2 parameters)	5-193
5.3.7	b, r codes (Speed control 3 and 4 parameters)	5-196
5.3.8	J codes (Applied functions)	5-197
[1]	PID command with the  /  keys on the keypad (J02 = 0, factory default)	5-198
[2]	PID command by analog inputs (J02 = 1)	5-199
[3]	PID command with UP/DOWN control (J02 = 3)	5-201
[4]	PID command via communications link (J02 = 4)	5-201
[5]	Overload stop function	5-213
[6]	Brake control signal	5-214
[7]	Positioning control with pulse counter	5-217
[8]	Servo lock	5-226
5.3.9	d codes (Applied functions 2)	5-228
[1]	Speed control	5-228
[2]	Master-follower operation	5-238
5.3.10	U codes (Customizable logic operation)	5-248
5.3.11	U1 codes (Customizable logic operation)	5-273
5.3.12	y codes (Link functions)	5-277

Chapter 6 TROUBLESHOOTING

6.1	Protective Function	6-1
6.2	Before Proceeding with Troubleshooting	6-2

6.3	If an Alarm Code Appears on the LED Monitor	6-3
6.3.1	Alarm code list.....	6-3
6.3.2	Causes, checks and measures of alarms	6-6
[1]	<i>LoF</i> PID feedback wire break.....	6-6
[2]	<i>dbA</i> Braking transistor broken.....	6-6
[3]	<i>dbH</i> Braking resistor overheat.....	6-6
[4]	<i>EEF</i> EN circuit failure.....	6-7
[5]	<i>EEL</i> Customizable logic failure.....	6-7
[6]	<i>EF</i> Ground fault	6-7
[7]	<i>Er-1</i> Memory error	6-7
[8]	<i>Er-2</i> Keypad communications error	6-8
[9]	<i>Er-3</i> CPU error	6-8
[10]	<i>Er-4</i> Option communications error.....	6-8
[11]	<i>Er-5</i> Option error	6-8
[12]	<i>Er-6</i> Operation error	6-9
[13]	<i>Er-7</i> Tuning error	6-9
[14]	<i>Er-B</i> RS-485 communications error (Communications port 1)/ <i>Er-P</i> RS-485 communications error (Communications port 2).....	6-10
[15]	<i>Er-d</i> Step-out detection/detection failure of magnetic pole position at startup.....	6-11
[16]	<i>Er-E</i> Speed inconsistency / Excessive speed deviation.....	6-12
[17]	<i>Er-F</i> Data saving error during undervoltage.....	6-13
[18]	<i>Er-H</i> Hardware error.....	6-13
[19]	<i>Er-o</i> Positioning control error.....	6-13
[20]	<i>Err</i> Simulated failure	6-14
[21]	<i>Er-t</i> CAN communications failure.....	6-14
[22]	<i>FLS</i> DC fuse-blowing	6-14
[23]	<i>L in</i> Input phase loss.....	6-15
[24]	<i>LU</i> Undervoltage.....	6-15
[25]	<i>OLn</i> Instantaneous overcurrent	6-16
[26]	<i>OH1</i> Cooling fin overheat.....	6-17
[27]	<i>OH2</i> External alarm.....	6-17
[28]	<i>OH3</i> Inverter internal overheat.....	6-17
[29]	<i>OH4</i> Motor protection (PTC thermistor)	6-18
[30]	<i>OH6</i> Charging resistor overheat.....	6-18
[31]	<i>OLn</i> Motor overloads 1 to 2	6-19
[32]	<i>OLU</i> Inverter overload.....	6-20
[33]	<i>OPL</i> Output phase-failure detection.....	6-20
[34]	<i>OS</i> Overspeed protection.....	6-21
[35]	<i>OLn</i> Overvoltage	6-21
[36]	<i>PbF</i> Charge circuit fault.....	6-22
[37]	<i>PG</i> PG wire break	6-22
6.4	If the "Light Alarm" Indication (<i>L -AL</i>) Appears on the LED Monitor.....	6-23
6.5	When Codes Other Than Alarm Codes and Light Alarm Indication (<i>L -AL</i>) are Displayed	6-24
6.5.1	Abnormal motor operation.....	6-24
[1]	The motor does not rotate	6-24
[2]	The motor rotates, but the speed does not increase	6-26
[3]	The motor runs in the opposite direction to the command.....	6-27
[4]	Speed fluctuation or current oscillation (e.g., hunting) occurs during running at constant speed	6-28
[5]	Unpleasant noises are emitted from motor or noises fluctuate	6-29
[6]	Motor is not accelerated or decelerated according to set-up acceleration or deceleration times	6-29
[7]	The motor does not restart even after the power recovers from a momentary power failure..	6-30
[8]	Motor generates heat abnormally	6-30

[9] The motor does not run as expected	6-30
[10] Motor stalls during acceleration	6-31
6.5.2 Problems with inverter settings	6-32
[1] Nothing appears on the LED monitor.....	6-32
[2] The desired menu is not displayed	6-32
[3] Display of under bars (_ _ _).....	6-33
[4] Display of center bars (- - -).....	6-33
[5] [{ }] Display of parenthesis.....	6-33
[6] Data of function codes cannot be changed.....	6-34
[7] Function code data are not changeable (change from link functions).....	6-34

Chapter 7 MAINTENANCE AND INSPECTION

7.1 Inspection Interval	7-1
7.2 Daily Inspection	7-2
7.3 Periodic Inspection	7-3
7.3.1 Periodic inspection 1--Before the inverter is powered ON or after it stops running	7-3
7.3.2 Periodic inspection 2--When the inverter is ON or it is running	7-4
7.4 List of Periodic Replacement Parts.....	7-5
7.4.1 Judgment on service life	7-6
[1] Measuring the capacitance of DC link bus capacitor in comparison with initial one at shipment	7-7
[2] Measuring the capacitance of the DC link bus capacitor under ordinary operating conditions.....	7-8
[3] Early warning of lifetime alarm.....	7-8
7.5 Measurement of Electrical Amounts in Main Circuit.....	7-9
7.6 Insulation Test.....	7-10
7.7 Inquiries about Product and Guarantee	7-11
7.7.1 When making an inquiry.....	7-11
7.7.2 Product warranty	7-11
[1] Free of charge warranty period and warranty range	7-11
[2] Exclusion of liability for loss of opportunity, etc.	7-12
[3] Repair period after production stop, spare parts supply period (holding period).....	7-12
[4] Transfer rights.....	7-12
[5] Service contents	7-12
[6] Applicable scope of service	7-12

Chapter 8 BLOCK DIAGRAMS FOR CONTROL LOGIC

8.1 Meanings of Symbols Used in the Control Block Diagrams.....	8-1
8.2 Frequency Setting Section.....	8-2
8.3 Operation Command Section	8-5
8.4 PID Control Section (for Processing).....	8-6
8.5 PID Control Section (for Dancer)	8-7
8.6 Control Section	8-8
8.6.1 V/f control	8-8
[1] Common	8-8
[2] Without speed sensor	8-9
[3] With speed sensor.....	8-10
8.6.2 Vector Control	8-11
[1] Common	8-11
[2] Torque command / Torque limit.....	8-12
[3] Speed control / Torque control.....	8-13
[4] Speed limit and Over speed protection processing	8-14
[5] For IM	8-15
[6] For PMSM	8-16

8.7	FM Output Section.....	8-18
-----	------------------------	------

Chapter 9 COMMUNICATION FUNCTIONS

9.1	Overview of RS-485 Communication.....	9-1
9.1.1	RS-485 common specifications.....	9-2
9.1.2	Terminal specifications.....	9-3
[1]	RS-485 communication port 1 (for connecting the keypad).....	9-3
[2]	RS-485 communication port 2 (only for FRN-E2■-2/4/7GA, -2/4/7J).....	9-4
[3]	RS-485 communication port 2 (terminal block) (only for FRN-E2■-2/4/7GB, -4C).....	9-4
9.1.3	Connection method.....	9-5
9.1.4	RS-485 connection devices.....	9-8
[1]	Converter.....	9-8
[2]	Requirements for the cable (COM port 1: for RJ-45 connector).....	9-9
[3]	Requirements for the cable (COM port 2: for RS-485 connector).....	9-9
[4]	Branch adapter for multi-drop.....	9-9
9.1.5	RS-485 noise suppression.....	9-9
9.2	CANopen Communication.....	9-10
9.2.1	Modes.....	9-10
9.2.2	Connection method.....	9-11
[1]	Basic connection configuration.....	9-11
[2]	Terminal mode.....	9-12
9.2.3	Inverter function codes related to CANopen setting.....	9-13
9.2.4	Procedures to establish CANopen communication.....	9-15
9.2.5	PDO protocol.....	9-16
[1]	About PDO protocol.....	9-16
[2]	Receive PDO (from master to inverter).....	9-17
[3]	Transmit PDO (from inverter to master).....	9-19
[4]	Communication parameters of receive PDO.....	9-20
[5]	Communication parameters of transmit PDO.....	9-21
[6]	Changing PDO (RPDO/TPDO) mapping entry.....	9-22
9.2.6	SDO protocol.....	9-23
[1]	About SDO.....	9-23
[2]	Response on SDO error.....	9-23
9.2.7	Other services.....	9-24
9.2.8	Object list.....	9-25
[1]	Objects in the communication profile area.....	9-25
[2]	Objects in the profile area specific to Fuji Electric.....	9-31
9.2.9	Standard device profile area.....	9-32
9.2.10	Inverter operation in CANopen communication.....	9-33
[1]	Operation according to CANopen's drive profile (DSP 402).....	9-33
[2]	Operation according to the inverter function code S06.....	9-38
9.2.11	Heartbeat and Node Guarding.....	9-42
[1]	Heartbeat.....	9-42
[2]	Node Guarding.....	9-43
9.2.12	Behavior upon detection of CANopen network disconnection.....	9-44
[1]	Related object and function code list.....	9-44
[2]	Restart from CANopen network disconnection failure.....	9-46
9.2.13	Alarm code list.....	9-47
9.2.14	Other points to note.....	9-48
9.2.15	Keypad LED operation monitor "3_40".....	9-49
9.2.16	Keypad LED operation monitor "3_41".....	9-49
9.2.17	Keypad LED operation monitor "3_42".....	9-49
9.2.18	Keypad LED maintenance information "5_45".....	9-49
9.2.19	Keypad LED maintenance information "5_46".....	9-49



9.3	FRENIC Loader Overview	9-50
9.3.1	Modes	9-50
9.3.2	Connection	9-51
9.3.3	Function overview	9-51
[1]	Configuring inverter's function code	9-51
[2]	Multi-monitor	9-52
[3]	Running status monitor	9-53
[4]	Test-running	9-54
[5]	Real-time trace	9-55
[6]	Historical trace	9-56
Chapter 10 SELECTING OPTIMAL MOTOR AND INVERTER CAPACITIES		
10.1	Motor Output Torque Characteristics	10-1
10.2	Selection Procedure	10-3
10.3	Equations for Selections	10-6
10.3.1	Load torque during constant speed running	10-6
[1]	General equation	10-6
[2]	Obtaining the required force F	10-6
10.3.2	Acceleration and deceleration time calculation	10-8
[1]	Calculation of moment of inertia	10-8
[2]	Calculation of the acceleration time	10-10
[3]	Calculation of the deceleration time	10-11
[4]	Calculating non-linear acceleration/deceleration time	10-11
[5]	Calculating non-linear deceleration time	10-12
10.3.3	Heat energy calculation of braking resistor	10-13
[1]	Calculation of regenerative energy	10-13
10.3.4	Calculating the RMS rating of the motor	10-14
10.4	Selecting an Inverter Drive Mode (ND/HD/HND/HHD)	10-15
10.4.1	Precaution in making the selection	10-15
10.4.2	Guideline for selecting inverter drive mode and capacity	10-16
Chapter 11 SELECTING PERIPHERAL EQUIPMENT		
11.1	Configuring the FRENIC-Ace	11-1
11.2	Currents Flowing Across the Inverter Terminals	11-2
11.3	Molded Case Circuit Breaker (MCCB), Residual-current-operated Protective Device (RCD)/ Earth Leakage Circuit Breaker (ELCB) and Magnetic Contactor (MC)	11-8
11.3.1	Function overview	11-8
11.3.2	Connection example and criteria for selection of circuit breakers	11-9
11.4	Surge Killers for L-load	11-15
11.5	Arresters	11-16
11.6	Surge Absorbers	11-17
11.7	Filtering Capacitors Suppressing AM Radio Band Noises	11-18
11.8	Braking Resistors (DBRs) and Braking Units	11-19
11.8.1	Selecting a braking resistor	11-19
[1]	Selection procedure	11-19
[2]	Notes on selection	11-19
11.8.2	Braking resistors (DBRs)	11-20
[1]	Standard model	11-20
[2]	10%ED model	11-20
11.8.3	Braking units	11-21
11.8.4	Specifications	11-22
11.8.5	External dimensions	11-31
11.9	Power Regenerative PWM Converters, RHC Series	11-33
11.9.1	Overview	11-33

11.9.2	Specifications	11-34
[1]	Standard specifications	11-34
[2]	Common specifications	11-35
11.9.3	Function specifications	11-36
11.9.4	Converter configuration	11-40
11.9.5	External dimensions	11-42
11.10	DC Reactors (DCRs)	11-47
11.11	AC Reactors (ACRs)	11-51
11.12	Surge Suppression Unit (SSU)	11-55
11.13	Output Circuit Filters (OFLs)	11-56
11.14	Zero-phase Reactors for Reducing Radio Noise (ACLs)	11-58
11.15	External Cooling Fan Attachments	11-59
11.16	External Frequency Command Potentiometer	11-61
11.17	Extension Cable for Remote Operation	11-62
11.18	Frequency Meters	11-63
11.19	Options for communication and operation overview	11-64
11.19.1	Mounting adapter (for communication option card)	11-64
11.19.2	Communication option cards (required mounting adapter required)	11-64
11.19.3	Terminal block type options	11-65
11.19.4	Option keypad	11-65
11.20	DeviceNet communications card (OPC-DEV)	11-66
11.20.1	DeviceNet specifications	11-66
11.21	CC-Link communications card (OPC-CCL)	11-67
11.21.1	CC-Link specifications	11-67
11.22	Digital I/O interface card (OPC-DIO)	11-68
11.23	Analog interface card (OPC-AIO)	11-70
11.24	RS-485 communication card (OPC-E2-RS)	11-73
11.25	PG interface card (OPC-E2-PG3)	11-75
11.25.1	Interface specifications (feedback side, PG interface)	11-75
11.25.2	Interface specifications (command side, pulse train interface)	11-76
11.25.3	Constraints on standard control circuit terminal	11-76
11.25.4	Terminal functions	11-77
11.25.5	Connection diagram	11-77
11.25.6	Voltage selection switch / Power supply selection jumper	11-78
11.26	PG interface card (OPC-E2-PG)	11-79
11.26.1	Interface specifications (feedback side, PG interface)	11-79
11.26.2	Interface specifications (command side, pulse train interface)	11-79
11.26.3	Constraints on standard control circuit terminal	11-80
11.26.4	Terminal functions	11-80
11.26.5	Connection diagram	11-81
11.26.6	Power supply selection jumper	11-81
11.27	Simple keypad with USB port (TP-E1U)	11-82
11.28	Multi functional keypad (TP-A1-E2C)	11-83
11.29	FRENIC Visual Customizer	11-84
11.29.1	Overview	11-84
11.29.2	Specifications	11-84
11.29.3	Functions	11-84
11.29.4	Main Window	11-85

Chapter 12 SPECIFICATIONS

12.1	Standard Model	12-1
12.1.1	ND-mode inverters for general load	12-1
12.1.2	HD-mode inverters for heavy duty load	12-4
12.1.3	HND-mode inverters for general load	12-7



12.1.4	HHD-mode inverters for heavy duty load	12-12
12.2	EMC Filter Built-in Type	12-18
12.2.1	ND-mode inverters for general load	12-18
12.2.2	HD-mode inverters for heavy duty load	12-18
12.2.3	HND-mode inverters for general load.....	12-19
12.2.4	HHD-mode inverters for heavy duty load	12-20
12.3	Common Specifications	12-21
 Chapter 13 EXTERNAL DIMENSIONS		
13.1	Standard Model (FRN0069E2S-2□/ FRN0044E2S-4□/ FRN0011E2S-7□ or below).....	13-1
13.2	Standard / EMC Filter Built-in Type (FRN0088E2■-2□/ FRN0059E2■-4□ or above).....	13-6
13.3	EMC Filter Built-in Type (FRN0069E2E-2□/ FRN0044E2E-4□/ FRN0012E2E-7□ or below)	13-14
13.4	Keypad	13-17
 APPENDICES		
Appendix A	Trouble-free Use of Inverters (Notes on electrical noise).....	1
A.1	Effect of inverters on other devices	1
[1]	Effect on AM radios.....	1
[2]	Effect on telephones	1
[3]	Effect on proximity switches	1
[4]	Effect on pressure sensors	1
[5]	Effect on position detectors (pulse encoders).....	1
A.2	Noise.....	2
[1]	Inverter noise	2
[2]	Types of noise	3
A.3	Measures	5
[1]	Noise prevention prior to installation.....	5
[2]	Implementation of noise prevention measures	5
[3]	Noise prevention examples	8
Appendix B	Japanese Guideline for Suppressing Harmonics by Customers Receiving High Voltage or Special High Voltage (General-purpose inverter).....	12
B.1	Application to general-purpose inverters	12
[1]	Guideline for suppressing harmonics in home electric and general-purpose appliances.....	12
[2]	Guideline for suppressing harmonics by customers receiving high voltage or special high voltage	12
B.2	Compliance to the harmonic suppression for customers receiving high voltage or special high voltage	13
[1]	Calculation of equivalent capacity (Pi).....	13
[2]	Calculation of Harmonic Current.....	14
[3]	Examples of calculation	16
Appendix C	Effect on Insulation of General-purpose Motors Driven with 400 V Class Inverters	17
C.1	Generating mechanism of surge voltages	17
C.2	Effect of surge voltages.....	18
C.3	Countermeasures against surge voltages.....	19
[1]	Using a surge suppressor unit, SSU (Patent pending)	19
[2]	Suppressing surge voltages	19
[3]	Using motors with enhanced insulation	19
C.4	Regarding existing equipment.....	20
[1]	In case of a motor being driven with 400 V class inverter.....	20
[2]	In case of an existing motor driven using a newly installed 400 V class inverter	20
Appendix D	Inverter Generating Loss.....	21
Appendix E	Conversion from SI Units.....	22
E.1	Conversion of units	22
E.2	Calculation formulas.....	23

Appendix F	Allowable Current of Insulated Wires	24
Appendix G	Conformity with Standards	26
G.1	Compliance with European Standards ()	26
[1]	Compliance with EMC standards	26
[2]	Compliance with the low voltage directive in the EU	31
G.2	Harmonic Component Regulation in the EU	38
[1]	General comments	38
[2]	Compliance with the harmonic component regulation	38
G.3	Compliance with UL Standards and Canadian Standards (cUL certification) ()	39
G.4	Compliance with the Radio Waves Act (South Korea) ()	45

■ Safety precautions

Read this manual thoroughly before proceeding with installation, connections (wiring), operation, or maintenance and inspection. Ensure you have sound knowledge of the device and familiarize yourself with all safety information and precautions before proceeding to operate the inverter.

Safety precautions are classified into the following two categories in this manual.

 WARNING	Failure to heed the information indicated by this symbol may lead to dangerous conditions, possibly resulting in death or serious bodily injuries.
 CAUTION	Failure to heed the information indicated by this symbol may lead to dangerous conditions, possibly resulting in minor or light bodily injuries and/or substantial property damage.

Failure to heed the information contained under the CAUTION title can also result in serious consequences. These safety precautions are of utmost importance and must be observed at all times.

Application

 WARNING
<ul style="list-style-type: none"> The FRENIC-Ace is designed to drive a three-phase induction motor. Do not use it for single-phase motors or for other purposes. Fire or an accident could occur. The FRENIC-Ace may not be used for a life-support system or other purposes directly related to the human safety. Though the FRENIC-Ace is manufactured under strict quality control, install safety devices for applications where serious accidents or property damages are foreseen in relation to the failure of it. An accident could occur.

Installation

 WARNING
<ul style="list-style-type: none"> Install the inverter on a base made of metal or other non-flammable material. Otherwise, a fire could occur. Do not place flammable object nearby. Doing so could cause fire. Inverters FRN0085E2■-4□ or above, whose protective structure is IP00, involve a possibility that a human body may touch the live conductors of the main circuit terminal block. Inverters to which an optional DC reactor is connected also involve the same. Install such inverters in an inaccessible place. Otherwise, electric shock or injuries could occur.

 CAUTION
<ul style="list-style-type: none"> Do not support the inverter by its front cover during transportation. Doing so could cause a drop of the inverter and injuries. Prevent lint, paper fibers, sawdust, dust, metallic chips, or other foreign materials from getting into the inverter or from accumulating on the heat sink. When changing the positions of the top and bottom mounting bases for external cooling, use only the specified screws. Otherwise, a fire or an accident might result. Do not install or operate an inverter that is damaged or lacking parts. Doing so could cause fire, an accident or injuries.

Wiring

WARNING

- If no zero-phase current (earth leakage current) detective device such as a ground-fault relay is installed in the upstream power supply line, in order to avoid the entire power supply system's shutdown undesirable to factory operation, install a residual-current-operated protective device (RCD)/earth leakage circuit breaker (ELCB) individually to inverters to break the individual inverter power supply lines only.

Otherwise, a fire could occur.

- When wiring the inverter to the power source, insert a recommended molded case circuit breaker (MCCB) or residual-current-operated protective device (RCD)/earth leakage circuit breaker (ELCB) (with overcurrent protection) in the path of each pair of power lines to inverters. Use the recommended devices within the recommended current capacity.
- Use wires in the specified size.
- Tighten terminals with specified torque.

Otherwise, a fire could occur.

- When there is more than one combination of an inverter and motor, do not use a multicore cable for the purpose of handling their wirings together.
- Do not connect a surge killer to the inverter's output (secondary) circuit.

Doing so could cause a fire.

- Be sure to connect an optional DC reactor (DCR) when the capacity of the power supply transformer exceeds 500 kVA and is 10 times or more the inverter rated capacity.

Otherwise, a fire could occur.

- Ground the inverter in compliance with the national or local electric code.
- Be sure to ground the inverter's grounding terminals .

Otherwise, an electric shock or a fire could occur.

- Qualified electricians should carry out wiring.
- Be sure to perform wiring after turning the power OFF.

Otherwise, an electric shock could occur.

- Be sure to perform wiring after installing the inverter unit.

Otherwise, an electric shock or injuries could occur.

- Ensure that the number of input phases and the rated voltage of the product match the number of phases and the voltage of the AC power supply to which the product is to be connected.

Otherwise, a fire or an accident could occur.

- Do not connect the power supply wires to output terminals (U, V, and W).
- When connecting a DC braking resistor (DBR), never connect it to terminals other than terminals P(+) and DB.

Doing so could cause fire or an accident.

- In general, sheaths of the control signal wires are not specifically designed to withstand a high voltage (i.e., reinforced insulation is not applied). Therefore, if a control signal wire comes into direct contact with a live conductor of the main circuit, the insulation of the sheath might break down, which would expose the signal wire to a high voltage of the main circuit. Make sure that the control signal wires will not come into contact with live conductors of the main circuit.

Doing so could cause an accident or an electric shock.

WARNING

- Before changing the switches or touching the control circuit terminal symbol plate, **turn OFF the power and wait at least five minutes for inverters FRN0115E2■-2□ / FRN0072E2■-4□ / FRN0011E2■-7□ or below, or at least ten minutes for inverters FRN0085E2■-4□ or above.** Make sure that the LED monitor and charging lamp are turned OFF. Further, make sure, using a multimeter or a similar instrument, that the DC link bus voltage between the terminals P(+) and N(-) has dropped to the safe level (+25 VDC or below).

Otherwise, an electric shock could occur.





CAUTION

- The inverter, motor and wiring generate electric noise. Be careful about malfunction of the nearby sensors and devices. To prevent them from malfunctioning, implement noise control measures.

Otherwise an accident could occur.

Operation

WARNING

- Be sure to mount the front cover before turning the power ON. Do not remove the cover when the inverter power is ON.
Otherwise, an electric shock could occur.
- Do not operate switches with wet hands.
Doing so could cause electric shock.
- If the auto-reset function has been selected, the inverter may automatically restart and drive the motor depending on the cause of tripping. Design the machinery or equipment so that human safety is ensured at the time of restarting.
Otherwise, an accident could occur.
- If the stall prevention function (current limiter), automatic deceleration (anti-regenerative control), or overload prevention control has been selected, the inverter may operate with acceleration/deceleration or frequency different from the commanded ones. Design the machine so that safety is ensured even in such cases.
- The  key on the keypad is effective only when the keypad operation is enabled with function code F02 (= 0, 2 or 3). When the keypad operation is disabled, prepare an emergency stop switch separately for safe operations.
Switching the run command source from keypad (local) to external equipment (remote) by turning ON the "Enable communications link" command **LE** disables the  key. To enable the  key for an emergency stop, select the  key priority with function code H96 (= 1 or 3).
- If any of the protective functions have been activated, first remove the cause. Then, after checking that the all run commands are set to OFF, release the alarm. If the alarm is released while any run commands are set to ON, the inverter may supply the power to the motor, running the motor.
Otherwise, an accident could occur.
- If you enable the "Restart mode after momentary power failure" (Function code F14 = 3 to 5), then the inverter automatically restarts running the motor when the power is recovered.
Design the machinery or equipment so that human safety is ensured after restarting.
- If the user configures the function codes wrongly without completely understanding this User's Manual, the motor may rotate with a torque or at a speed not permitted for the machine.
- Starting auto-tuning involves motor rotation. Sufficiently check that motor rotation brings no danger beforehand.
An accident or injuries could occur.
- Even if the inverter has interrupted power to the motor, if the voltage is applied to the main circuit input terminals L1/R, L2/S, L3/T, L1/L and L2/N, voltage may be output to inverter output terminals U, V, and W.
- Even if the motor is stopped due to DC braking or preliminary excitation, voltage is output to inverter output terminals U, V, and W.
An electric shock may occur.
- The inverter can easily accept high-speed operation. When changing the speed setting, carefully check the specifications of motors or equipment beforehand.
Otherwise, injuries could occur.

CAUTION

- Do not touch the heat sink and braking resistor because they become very hot.
Doing so could cause burns.
- The DC brake function of the inverter does not provide any holding mechanism.
Injuries could occur.
- Ensure safety before modifying the function code settings.
Run commands (e.g., "Run forward" **FWD**), stop commands (e.g., "Coast to a stop" **BX**), and frequency change commands can be assigned to digital input terminals. Depending upon the assignment states of those terminals, modifying the function code setting may cause a sudden motor start or an abrupt change in speed.
- When the inverter is controlled with the digital input signals, switching run or frequency command sources with the related terminal commands (e.g., **SS1, SS2, SS4, SS8, Hz2/Hz1, Hz/PID, IVS**, and **LE**) may cause a sudden motor start or an abrupt change in speed.
- Ensure safety before modifying customizable logic related function code settings (U codes and related function codes) or turning ON the "Cancel customizable logic" terminal command **CLC**. Depending upon the settings, such modification or cancellation of the customizable logic may change the operation sequence to cause a sudden motor start or an unexpected motor operation.
An accident or injuries could occur.

Maintenance and inspection, and parts replacement

WARNING

- Before proceeding to the maintenance/inspection jobs, **turn OFF the power and wait at least five minutes for inverters FRN0115E2■-2□ / FRN0072E2■-4□ / FRN0011E2■-7□ or below, or at least ten minutes for inverters FRN0085E2■-4□ or above.** Make sure that the LED monitor and charging lamp are turned OFF. Further, make sure, using a multimeter or a similar instrument, that the DC link bus voltage between the terminals P(+) and N(-) has dropped to the safe level (+25 VDC or below).

Otherwise, an electric shock could occur.

- Always carry out the daily and periodic inspections described in the instruction/user's manual. Use of the inverter for long periods of time without carrying out regular inspections could result in malfunction or damage, and an accident or fire could occur.
- It is recommended that periodic inspections be carryout every one to two years, however, they should be carried out more frequently depending on the usage conditions.
- It is recommended that parts for periodic replacement be replaced in accordance with the standard replacement frequency indicated in the user's manual. Use of the product for long periods of time without replacement could result in malfunction or damage, and an accident or fire could occur.
- Contact outputs [30A/B/C] use relays, and may remain ON, OFF, or undetermined when their lifetime is reached. In the interests of safety, equip the inverter with an external protective function.

Otherwise, an accident or fire could occur.

- Maintenance, inspection, and parts replacement should be made only by qualified persons.
- Take off the watch, rings and other metallic objects before starting work.
- Use insulated tools.

Otherwise, an electric shock or injuries could occur.

- Never modify the inverter.

Doing so could cause an electric shock or injuries.

Disposal

CAUTION

- Treat the inverter as an industrial waste when disposing of it.

Otherwise injuries could occur.

GENERAL PRECAUTIONS

Drawings in this manual may be illustrated without covers or safety shields for explanation of detail parts. Restore the covers and shields in the original state and observe the description in the manual before starting operation.

Icons

The following icons are used throughout this manual.



This icon indicates information which, if not heeded, can result in the inverter not operating to full efficiency, as well as information concerning incorrect operations and settings which can result in accidents.



This icon indicates information that can be useful when performing certain settings or operations.



This icon indicates a reference to more detailed information.

Chapter 1

BEFORE USE

This chapter explains the items to be checked before the use of the inverter.

Contents

1.1	Acceptance Inspection (Nameplates and Inverter Type)	1-1
1.2	External View and Terminal Blocks	1-3
1.3	Precautions for Using Inverters	1-5
1.3.1	Usage environment	1-5
1.3.2	Storage environment	1-7
[1]	Temporary storage	1-7
[2]	Long-term storage	1-7
1.3.3	Precautions for connection of peripheral equipment	1-8
[1]	Phase-advancing capacitors for power factor correction	1-8
[2]	Power supply lines (Application of a DC/AC reactor)	1-8
[3]	DC reactor (DCR) for correcting the inverter input power factor (for suppressing harmonics)	1-8
[4]	PWM converter for correcting the inverter input power factor	1-8
[5]	Molded case circuit breaker (MCCB) / residual-current-operated protective device (RCD) / earth leakage circuit breaker (ELCB)	1-9
[6]	Magnetic contactor (MC) in the inverter input (primary) circuit	1-9
[7]	Magnetic contactor (MC) in the inverter output (secondary) circuit	1-9
[8]	Surge absorber/surge killer	1-9
1.3.4	Noise reduction	1-10
1.3.5	Leakage current	1-10
1.3.6	Precautions in driving a permanent magnet synchronous motor (PMSM)	1-10

1.1 Acceptance Inspection (Nameplates and Inverter Type)

Unpack the package and check the following:

- (1) An inverter and the following accessories are contained in the package.
 - Accessories - DC reactor (for ND-mode inverters of FRN0139E2■-4G□ or above, HD/HND-mode inverters of FRN0168E2■-4G□ or above, and HHD-mode inverters of FRN0203E2■-4G□ or above) (Not included with the FRN****E2■-4C(china model))
 - Keypad rear cover (with three screws for securing the keypad)
 - Instruction manual
 - CD-ROM (containing the FRENIC-Ace User's Manual)
- (2) The inverter has not been damaged during transportation—there should be no dents or parts missing.
- (3) The inverter is the type you ordered. You can check the type and specifications on the main nameplate. (The main and sub nameplates are attached to the inverter as shown on Figure 1.2-1.)

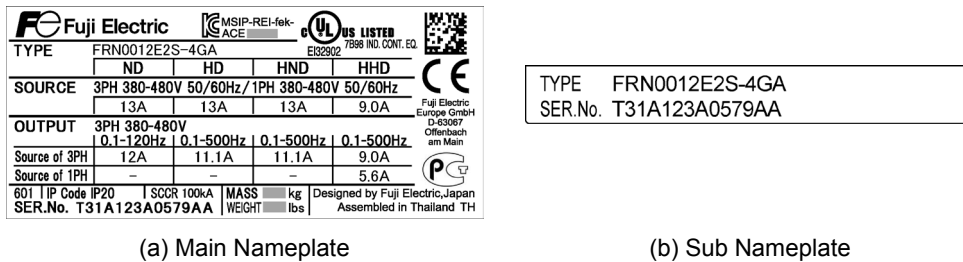

Figure 1.1-1 Nameplates

TYPE: Type of inverter

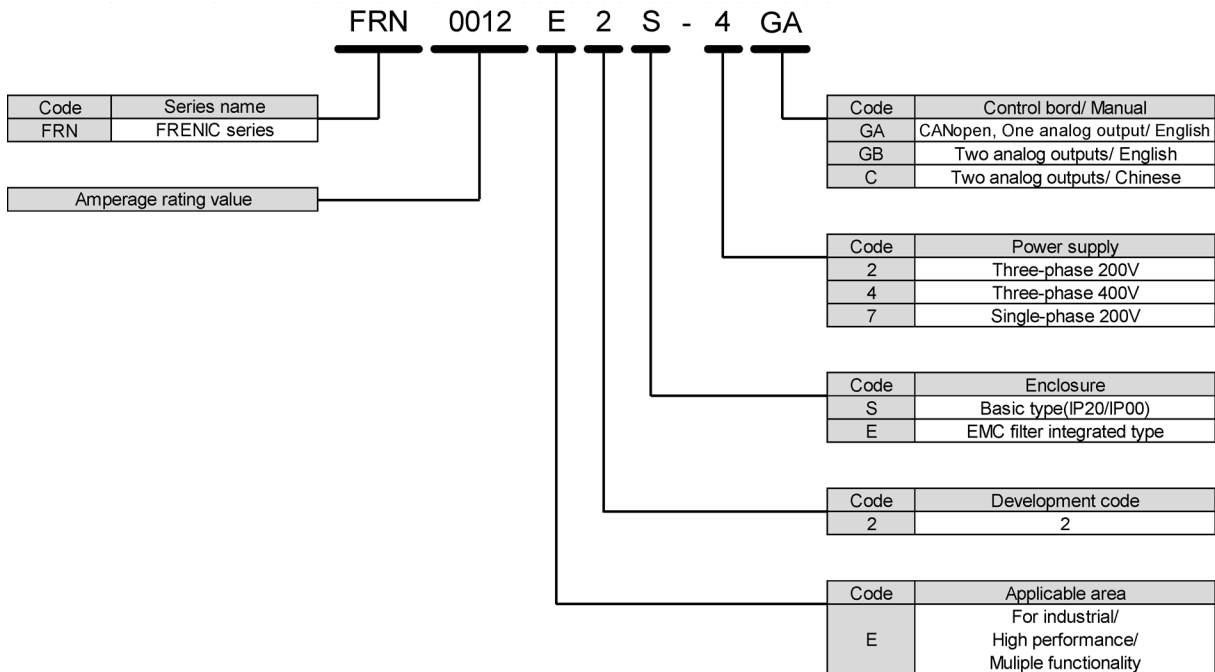

Figure 1.1-2 Type of inverter

1.1 Acceptance Inspection (Nameplates and Inverter Type)

The FRENIC-Ace is available in four different drive modes--ND (Normal Duty), HD (Heavy Duty), HND (High, Normal Duty), and HHD (High, Heavy Duty). One of these modes should be selected to match the load property of your system. Specifications in each mode are printed on the main nameplate.

- ND mode : Designed for general load applications.
Overload capability: 120% for 1 min.
- HD mode : Designed for heavy duty load applications.
Overload capability: 150% for 1 min.
- HND mode : Designed for general load applications.
Overload capability: 120% for 1 min.
- HHD mode : Designed for heavy duty load applications.
Overload capability: 150% for 1 min. and 200% for 0.5 s.
- SOURCE : Number of input phases (three-phase: 3PH), input voltage, input frequency, input current
- OUTPUT : Number of output phases, rated output voltage, output frequency range, rated output capacity, rated output current, and overload capability
- SCCR : Short-circuit capacity
- MASS : Mass of the inverter in kilogram
- SER. No. : Product number

6 8 A 1 2 3 A 0 5 7 9 E BB 6 0 1

Production week
This indicates the week number that is numbered from 1st week of January.
The 1st week of January is indicated as '01'.
Production year: Last digit of year
Product version



: Compliance with European Standards (See Appendix G Section G-1)



: Compliance with UL Standards and Canadian Standards (cUL certification)
(See Appendix G Section G-2)



: Compliance with the Radio Waves Act (South Korea) (See Appendix G Section G-3)



: Compliance with Russian Standards

If you suspect the product is not working properly or if you have any questions about your product, contact your Fuji Electric representative.

1.2 External View and Terminal Blocks

(1) Outside and inside views

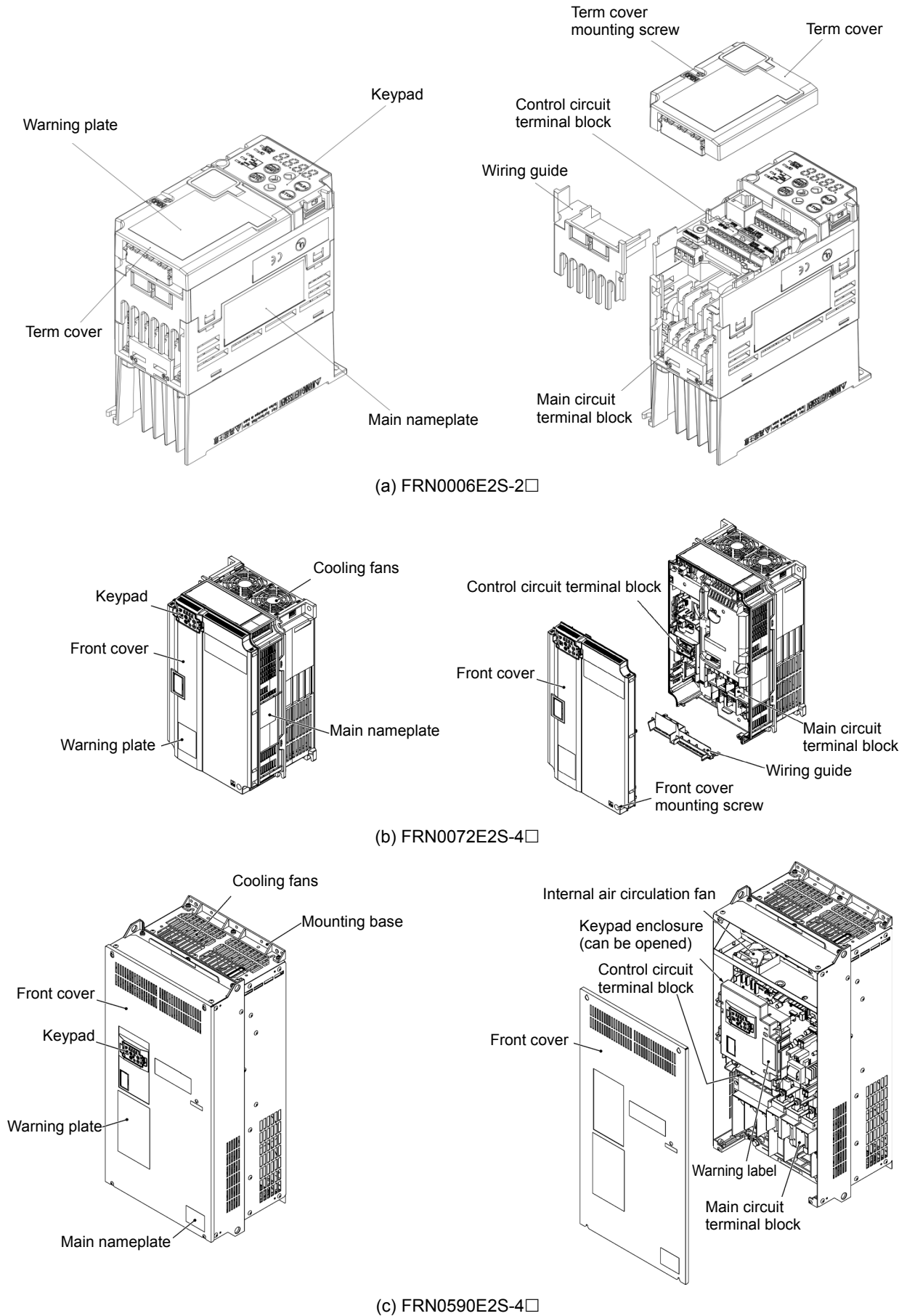

Figure 1.2-1 Outside and Inside Views of Inverters

(2) Warning plates and label

 WARNING
<ul style="list-style-type: none"> ■ RISK OF INJURY OR ELECTRIC SHOCK • Refer to the instruction manual before installation and operation. • Do not remove any cover while applying power and at least 5min. after disconnecting power. • Securely ground (earth) the equipment. • High touch current.
 AVERTISSEMENT
<ul style="list-style-type: none"> ■ RISQUE DE BLESSURE OU DE CHOC ÉLECTRIQUE • Ne retirez pas le couvercle lorsque vous mettez sous tension. • Ce couvercle peut être retiré au moins 5 minutes après la mise hors tension et quand le témoin «ACTIF» s'éteint. • Plus d'un circuité électrique actif. Reportez-vous au manuel d'instruction.
 警告
<ul style="list-style-type: none"> ■ けが、感電のおそれあり • 据え付け、運転の前に必ず取扱説明書を読んでその指示に従うこと。 • 通電中および電源しゃ断後5分以内は表面カバーを開けないこと。 • 確実に接地をおこなうこと。
<p>Only type B of RCD is allowed. See manual for details.</p>

(a) FRN0006E2■-4G□

 WARNING
<ul style="list-style-type: none"> ■ RISK OF INJURY OR ELECTRIC SHOCK • Refer to the instruction manual before installation and operation. • Do not remove this cover while applying power. • This cover can be removed after at least 10 min of power off and after the "CHARGE" lamp turns off. • More than one live circuit. See instruction manual. • Do not insert fingers or anything else into the inverter. • Securely ground (earth) the equipment. • High touch current.
 警告
<ul style="list-style-type: none"> ■ 有可能引起受伤、触电 • 安装运行之前请务必阅读操作说明书并遵照其指示 • 通電中不要打开表面盖板 • 断電10分钟以上、充电指示灯熄灭后才可打开表面盖板 • 打开表盖时,要确认已经切断各路的辅助电源 (请参考说明书) • 即使在安装了表面盖板时,也不要从缝隙同插入手指或其他异物 • 请正确接地
 警告
<ul style="list-style-type: none"> ■ けが、感電のおそれあり • 据え付け運転の前に、必ず取扱説明書を読んでその指示に従うこと。 • 通電中は、表面カバーを開けないこと。 • 表面カバーを開ける場合は、電流しゃ断後10分以上経過後チャージランプが消灯したのを確認してから行うこと。 • 表面カバーを開ける場合は、各補助電源もしゃ断していることを確認してから行うこと (取扱説明書を参照のこと)。 • 表面カバー取付状態であっても、開口部より装置内部に指や物等挿入しないこと。 • 確実に接地をおこなうこと。
<p>Only type B of RCD is allowed. See manual for details.</p>

(b) FRN0203E2■-4G□

 AVERTISSEMENT
<ul style="list-style-type: none"> ■ RISQUE DE BLESSURE OU DE CHOC ÉLECTRIQUE • Ne retirez pas le couvercle lorsque vous mettez sous tension. • Ne pas ouvrir cette couvercle pendant 10 minutes après avoir coupé l'alimentation ou lors de la mise sous tension. • Plus d'un circuit électrique actif. Reportez-vous au manuel d'instruction.

Figure 1.2-2 Warning Plates and Label

1.3 Precautions for Using Inverters

Fuji Electric strongly recommends installing inverters in a panel for safety reasons, in particular, when installing the ones whose enclosure rating is IP00.

When installing the inverter in a place out of the specified environmental requirements, it is necessary to derate the inverter or consider the panel engineering design suitable for the special environment or the panel installation location. For details, refer to the Fuji Electric technical information "Engineering Design of Panels" or consult your Fuji Electric representative.

The special environments listed below require using the specially designed panel or considering the panel installation location.

Environments	Possible problems	Sample measures	Applications
Highly concentrated sulfidizing gas or other corrosive gases	Corrosive gases cause parts inside the inverter to corrode, resulting in an inverter malfunction.	Any of the following measures may be necessary. <ul style="list-style-type: none"> - Mount the inverter in a sealed panel with IP6X or air-purge mechanism. - Place the panel in a room free from influence of the gases. 	Paper manufacturing, sewage disposal, sludge treatment, tire manufacturing, gypsum manufacturing, metal processing, and a particular process in textile factories.
A lot of conductive dust or foreign material (e.g., metal powders or shavings, carbon fibers, or carbon dust)	Entry of conductive dust into the inverter causes a short circuit.	Any of the following measures may be necessary. <ul style="list-style-type: none"> - Mount the inverter in a sealed panel. - Place the panel in a room free from influence of the conductive dust. 	Wiredrawing machines, metal processing, extruding machines, printing presses, combustors, and industrial waste treatment.
A lot of fibrous or paper dust	Fibrous or paper dust accumulated on the heat sink lowers the cooling effect. Entry of dust into the inverter causes the electronic circuitry to malfunction.	Any of the following measures may be necessary. <ul style="list-style-type: none"> - Mount the inverter in a sealed panel that shuts out dust. - Ensure a maintenance space for periodical cleaning of the heat sink in panel engineering design. - Employ external cooling when mounting the inverter in a panel for easy maintenance and perform periodical maintenance. 	Textile manufacturing and paper manufacturing.
High humidity or dew condensation	In an environment where a humidifier is used or where the air conditioner is not equipped with a dehumidifier, high humidity or dew condensation results, which causes a short-circuiting or malfunction of electronic circuitry inside the inverter.	<ul style="list-style-type: none"> - Put a heating module such as a space heater in the panel. 	Outdoor installation. Film manufacturing line, pumps and food processing.
Vibration or shock exceeding the specified level	If a large vibration or shock exceeding the specified level is applied to the inverter, for example, due to a carrier running on seam joints of rails or blasting at a construction site, the inverter structure gets damaged.	<ul style="list-style-type: none"> - Insert shock-absorbing materials between the mounting base of the inverter and the panel for safe mounting. 	Installation of an inverter panel on a carrier or self-propelled machine. Ventilating fan at a construction site or a press machine.
Fumigation for export packaging	Halogen compounds such as methyl bromide used in fumigation corrodes some parts inside the inverter.	<ul style="list-style-type: none"> - When exporting an inverter built in a panel or equipment, pack them in a previously fumigated wooden crate. - When packing an inverter alone for export, use a laminated veneer lumber (LVL). 	Exporting.

1.3.2 Storage environment

The storage environment in which the inverter should be stored after purchase differs from the usage environment. Store the inverter in an environment that satisfies the requirements listed below.

[1] Temporary storage

Table 1.3-3 Storage and Transport Environments

Item	Specifications	
Storage temperature *1	During transport: -25 to +70°C (-13 to +158°F)	Places not subjected to abrupt temperature changes or condensation or freezing
	During storage: -25 to +65°C (-13 to +153°F)	
Relative humidity	5 to 95% RH *2	
Atmosphere	The inverter must not be exposed to dust, direct sunlight, corrosive or flammable gases, oil mist, vapor, water drops or vibration. The atmosphere must contain only a low level of salt. (0.01 mg/cm ² or less per year)	
Atmospheric pressure	86 to 106 kPa (during storage)	
	70 to 106 kPa (during transportation)	

*1 Assuming comparatively short time storage, e.g., during transportation or the like.

*2 Even if the humidity is within the specified requirements, avoid such places where the inverter will be subjected to sudden changes in temperature that will cause condensation or freezing.

Precautions for temporary storage

- (1) Do not leave the inverter directly on the floor.
- (2) If the environment does not satisfy the specified requirements listed in Table 1.3-3, wrap the inverter in an airtight vinyl sheet or the like for storage.
- (3) If the inverter is to be stored in a high-humidity environment, put a drying agent (such as silica gel) in the airtight package described in (2) above.

[2] Long-term storage

The long-term storage method of the inverter varies largely according to the environment of the storage site. General storage methods are described below.

- (1) The storage site must satisfy the requirements specified for temporary storage.
However, for storage exceeding three months, the surrounding temperature range should be within the range from -10 to +30°C (14 to 86°F). This is to prevent electrolytic capacitors in the inverter from deterioration.
- (2) The package must be airtight to protect the inverter from moisture. Add a drying agent inside the package to maintain the relative humidity inside the package within 70%.
- (3) If the inverter has been installed to the equipment or panel at construction sites where it may be subjected to humidity, dust or dirt, then temporarily remove the inverter and store it in the environment specified in Table 1.3-3.

Precautions for storage over 1 year

If the inverter has not been powered on for a long time, the property of the electrolytic capacitors may deteriorate. Power the inverters on once a year and keep the inverters powering on for 30 to 60 minutes. Do not connect the inverters to the load circuit (secondary side) or run the inverter.

1.3.3 Precautions for connection of peripheral equipment

[1] Phase-advancing capacitors for power factor correction

Do not mount a phase-advancing capacitor for power factor correction in the inverter's input (primary) or output (secondary) circuit. Mounting it in the input (primary) circuit takes no effect. To correct the inverter power factor, use an optional DC reactor (DCR). Mounting it in the output (secondary) circuit causes an overcurrent trip, disabling operation.

An overvoltage trip that occurs when the inverter is stopped or running with a light load is assumed to be due to surge current generated by open/close of phase-advancing capacitors in the power system. An optional DC/AC reactor (DCR/ACR) is recommended as a measure to be taken at the inverter side.

Inverter input current to an inverter contains harmonic components that may affect other motors and phase-advancing capacitors on the same power supply line. If the harmonic components cause any problems, connect a DCR/ACR to the inverter. In some cases, it is necessary to insert a reactor in series with the phase-advancing capacitors.

[2] Power supply lines (Application of a DC/AC reactor)

Use a DC reactor (DCR) when the capacity of the power supply transformer is 500 kVA or more and is 10 times or more the inverter rated capacity or when there are thyristor-driven loads. If no DCR is used, the percentage-reactance of the power supply decreases, and harmonic components and their peak levels increase. These factors may break rectifiers or capacitors in the converter section of the inverter, or decrease the capacitance of the capacitors.

If the input voltage unbalance rate is between 2% and 3%, use an optional AC reactor (ACR).

$$\text{Voltage unbalance (\%)} = \frac{\text{Max. voltage (V)} - \text{Min. voltage (V)}}{\text{Three - phase average voltage (V)}} \times 67 \text{ (IEC/EN61800 - 3)}$$

[3] DC reactor (DCR) for correcting the inverter input power factor (for suppressing harmonics)

To correct the inverter input power factor (to suppress harmonics), use a DCR. Using a DCR increases the reactance of inverter's power source so as to decrease harmonic components on the power source lines and correct the power factor of the inverter.

DCR models	Input power factor	Remarks
DCR2/4-□□/□□A/□□B	Approx. 90% to 95%	The last letter identifies the capacitance.
DCR2/4-□□C	Approx. 86% to 90%	Exclusively designed when applying with motors with a rated capacity of 37 kW or above.

- Note**
- Select a DCR matching not the inverter capacity but the rated capacity of the applied motor. Applicable reactors differ depending upon the selected ND, HD, HND or HHD mode even on the same type of inverters.
 - For applied motors of 75 kW or above, be sure to connect a DCR to the inverter.

[4] PWM converter for correcting the inverter input power factor

Using a PWM converter (High power-factor, regenerative PWM converter, RHC series) corrects the inverter power factor up to nearly "1."

When combining an inverter with a PWM converter, disable the main power down detection by setting the function code H72 to "0" (default). If the main power down detection is enabled (H72 = 1, factory default), the inverter interprets the main power as being shut down, ignoring an entry of a run command.

[5] Molded case circuit breaker (MCCB) / residual-current-operated protective device (RCD) / earth leakage circuit breaker (ELCB)



Install a recommended MCCB or RCD/ELCB (with overcurrent protection) in the primary circuit of the inverter to protect the wiring. Since using an MCCB or RCD/ELCB with a larger capacity than recommended ones breaks the protective coordination of the power supply system, be sure to select recommended ones. Also select ones with short-circuit breaking capacity suitable for the power source impedance.

⚠ WARNING

If no zero-phase current (earth leakage current) detective device such as a ground-fault relay is installed in the upstream power supply line in order to avoid the entire power supply system's shutdown undesirable to factory operation, install a residual-current-operated protective device (RCD)/earth leakage circuit breaker (ELCB) individually to inverters to break the individual inverter power supply lines only.

Otherwise, a fire could occur.

[6] Magnetic contactor (MC) in the inverter input (primary) circuit

Avoid frequent ON/OFF operation of the magnetic contactor (MC) in the input circuit; otherwise, the inverter failure may result. If frequent start/stop of the motor is required, use **FWD/REV** terminal signals or the  /  keys on the inverter's keypad.

The frequency of the MC's ON/OFF should not be more than once per 30 minutes. To assure 10-year or longer service life of the inverter, it should not be more than once per hour.

-  • From the system's safety point of view, it is recommended to employ such a sequence that shuts down the magnetic contactor (MC) in the inverter input circuit with an alarm output signal **ALM** issued on inverter's programmable output terminals. The sequence minimizes the secondary damage even if the inverter breaks.

When the sequence is employed, connecting the MC's primary power line to the inverter's auxiliary control power input makes it possible to monitor the inverter's alarm status on the keypad.

- The breakdown of a braking unit or misconnection of an external braking resistor may cause damage of the inverter's internal parts (e.g., charging resistor). To avoid such a breakdown linkage, introduce an MC and configure a sequence that shuts down the MC if a DC link voltage establishment signal is not issued within three seconds after the MC is switched on.

For the braking transistor built-in type of inverters, assign a transistor error output signal **DBAL** on inverter's programmable output terminals to switch off the MC in the inverter input circuit.

[7] Magnetic contactor (MC) in the inverter output (secondary) circuit

If a magnetic contactor (MC) is inserted in the inverter's output (secondary) circuit for switching the motor to a commercial power or for any other purposes, it should be switched on and off when both the inverter and motor are completely stopped. This prevents the contact point from getting damaged due to a switching arc of the MC. The MC should not be equipped with any main circuit surge killer.

Applying a commercial power to the inverter's output circuit breaks the inverter. To avoid it, interlock the MC on the motor's commercial power line with the one in the inverter output circuit so that they are not switched ON at the same time.

[8] Surge absorber/surge killer

Do not install any surge absorber or surge killer in the inverter's output (secondary) lines.

1.3.4 Noise reduction

If noise generated from the inverter affects other devices, or that generated from peripheral equipment causes the inverter to malfunction, follow the basic measures outlined below.

- (1) If noise generated from the inverter affects the other devices through power wires or grounding wires:
 - Isolate the grounding terminals of the inverter from those of the other devices.
 - Connect a noise filter to the inverter power wires.
 - Isolate the power system of the other devices from that of the inverter with an insulated transformer.
 - Decrease the inverter's carrier frequency (F26). See **Note** below.
- (2) If induction or radiated noise generated from the inverter affects other devices:
 - Isolate the main circuit wires from the control circuit wires and other devices wires.
 - Put the main circuit wires through a metal conduit pipe, and connect the pipe to the ground near the inverter.
 - Install the inverter into the metal panel and connect the whole panel to the ground.
 - Connect a noise filter to the inverter's power wires.
 - Decrease the inverter's carrier frequency (F26). See **Note** below.
- (3) When implementing measures against noise generated from peripheral equipment:
 - For inverter's control signal wires, use twisted or shielded-twisted wires. When using shielded-twisted wires, connect the shield of the shielded wires to the common terminals of the control circuit.
 - Connect a surge absorber in parallel with magnetic contactor's coils or other solenoids (if any).

Note: Running a permanent magnet synchronous motor (PMSM) at a low carrier frequency may heat the permanent magnet due to the output current harmonics, resulting in demagnetization. When decreasing the carrier frequency setting, be sure to check the allowable carrier frequency of the motor.

1.3.5 Leakage current

A high frequency current component generated by insulated gate bipolar transistors (IGBTs) switching on/off inside the inverter produces leakage current through stray capacitance of inverter input and output wires or a motor. If any of the problems listed below occurs, take an appropriate measure against them.

Problem	Measures
An earth leakage circuit breaker* that is connected to the input (primary) side has tripped. * With overcurrent protection	1) Decrease the carrier frequency. See Note below. 2) Make the wires between the inverter and motor as short as possible. 3) Use an earth leakage circuit breaker with lower sensitivity than the one currently used. 4) Use an earth leakage circuit breaker that features measures against the high frequency current component (Fuji SG and EG series).
An external thermal relay was falsely activated.	1) Decrease the carrier frequency. See Note below. 2) Increase the current setting of the thermal relay. 3) Use the electronic thermal overload protection built in the inverter, instead of the external thermal relay.

Note: Running a permanent magnet synchronous motor (PMSM) at a low carrier frequency may heat the permanent magnet due to the output current harmonics, resulting in demagnetization. When decreasing the carrier frequency setting, be sure to check the allowable carrier frequency of the motor.

1.3.6 Precautions in driving a permanent magnet synchronous motor (PMSM)

When using a PMSM, note the following.

- When using a PMSM other than the Fuji standard synchronous motor (GNB2), consult your Fuji Electric representative.
- A single inverter cannot drive two or more PMSMs.
- A PMSM cannot be driven by commercial power.

Chapter 2 INSTALLATION AND WIRING

This chapter describes the important points in installing and wiring inverters.

Contents

2.1	Installation	2-1
2.2	Wiring	2-3
2.2.1	Basic connection diagram	2-3
2.2.2	Removal and attachment of the front cover/ terminal cover and wiring guide	2-6
2.2.3	Precautions for wiring	2-8
2.2.4	Precautions for long wiring (between inverter and motor)	2-10
2.2.5	Main circuit terminals	2-12
[1]	Screw specifications	2-12
[2]	Terminal layout diagram (main circuit terminal)	2-15
[3]	Recommended wire size (main circuit terminals)	2-17
[4]	Description of terminal functions (main circuit terminal)	2-38
2.2.6	Control circuit terminals (common to all models)	2-42
[1]	Screw specifications and recommended wire size (control circuit terminals)	2-42
[2]	Terminal layout diagram (control circuit terminal)	2-42
[3]	Description of terminal functions (control circuit terminal)	2-43
2.2.7	Switching connector (types FRN0203E2■-4□ or above)	2-51
2.2.8	Operating slide switches	2-53
2.3	Attachment and Connection of Keypad	2-55
2.3.1	Parts required for connection	2-55
2.3.2	Attachment procedure	2-55
2.4	RJ-45 Cover	2-59

2.1 Installation

(1) Installation Environment

Please install FRENIC-Ace in locations which meet the conditions specified in Chapter 1 “1.3.1 Usage environment”.

(2) Installation Surface

Please install the inverter on non-combustible matter such as metals. Also, do not mount it upside down or horizontally.

⚠ WARNING
Install on non-combustible matter such as metals.
Risk of fire exists

(3) Surrounding Space

Secure the space shown in Figure 2.1-1 and Table 2.1-1. When enclosing FRENIC-Ace in cabinets, be sure to provide adequate ventilation to the cabinet, as the surrounding temperature may rise. Do not contain it in small enclosures with low heat dissipation capacity.

■ Installation of Multiple Inverters

When installing 2 or more units in the same equipment or cabinet, generally mount them to the side of each other, not above each other. When the inverters are mounted above each other, attach partitioning boards to prevent that the heat dissipated from the lower inverter affects the upper inverter.

For types FRN0072E2-4□, FRN0115E2-2□, FRN0011E2-7□ or below and for ambient temperature below 40°C only, the units can be installed side by side without any spacing between them. (30°C or lower for ND and HD)

Table 2.1-1 Surrounding Space mm (inch)

Applicable Capacity	A	B	C
200 V class: FRN0001 to 0115E2-2□	10	100 (3.9)	0 *1
200 V class: FRN0001 to 0011E2-7□	(0.39)		
400 V class: FRN0002 to 0072E2-4□	50		100 (3.9)
400 V class: FRN0085 to 0590E2-4□	(1.97)		

*1 A clearance of 50 mm is required to use RJ45 connector.

C: Space in front of the inverter unit

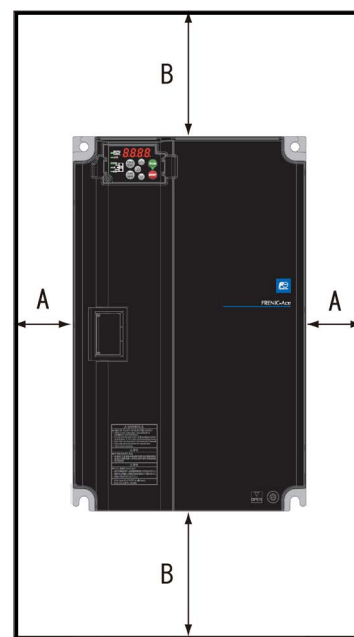

Figure 2.1-1 Installation Direction

■ Installation with External Cooling

The external cooling installation reduces the generated heat inside the panel by dissipating approximately 70% of the total heat generated (total heat loss) by mounting the cooling fins protruding outside the equipment or cabinet.

Installation with external cooling is possible for types FRN0030 to 0115E2-2□ and FRN0022 to 0072E2-4□ by adding attachments (optional) for external cooling, and for types FRN0085E2-4□ or above by moving the mounting bases.

(Please refer to Chapter 11 Item 11.15 for the external dimensions drawing of the external cooling attachment (optional)).

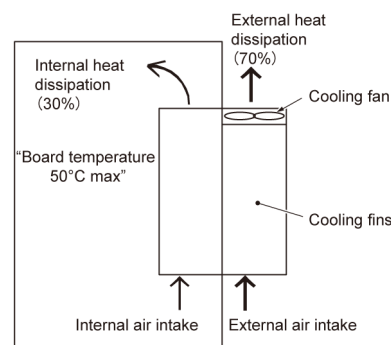

Figure 2.1-2 Installation with External Cooling

⚠ CAUTION
Prevent lint, wastepaper, wood shavings, dust, metal scrap, and other foreign material from entering the inverter or from attaching to the cooling fins.
Risk of fire and risk of accidents exist

To install the FRN0085E2-4□ inverter with external cooling, change the mounting position of the mounting bases following the procedure in Figure 2.1-3.

As the type and number of screws differ by inverter type, please review Table 2.1-2.

Table 2.1-2 Type and Number of Screws, and Tightening Torque

Inverter type	Mounting base fixation screw	Case attachment screw	Tightening torque N·m (lb-in)
FRN0085E2-4□ to FRN0168E2-4□	M6×20 (5 screws on top, 3 screws on bottom)	M6×20 (2 screws on top only)	5.8 (51.3)
FRN0203E2-4□	M6×20 (3 screws on top and bottom each)	M6×12 (3 screws on top only)	5.8 (51.3)
FRN0240E2-4□ to FRN0290E2-4□	M5×12 (7 screws on top and bottom each)	M5×12 (7 screws on top only)	3.5 (31.0)
FRN0361E2-4□ to FRN0415E2-4□	M5×16 (7 screws on top and bottom each)	M5×16 (7 screws on top only)	3.5 (31.0)
FRN0520E2-4□ to FRN0590E2-4□	M5×16 (8 screws on top and bottom each)	M5×16 (8 screws on top only)	3.5 (31.0)

- 1) Remove all of the mounting base fixation screws and the case attachment screws on the top of the inverter.
- 2) Fix the mounting bases to the case attachment screw holes using the mounting base fixation screws. A few screws should remain after changing the position of the mounting bases.
- 3) Change the position of the mounting bases on the bottom side following the procedure in 1) and 2).

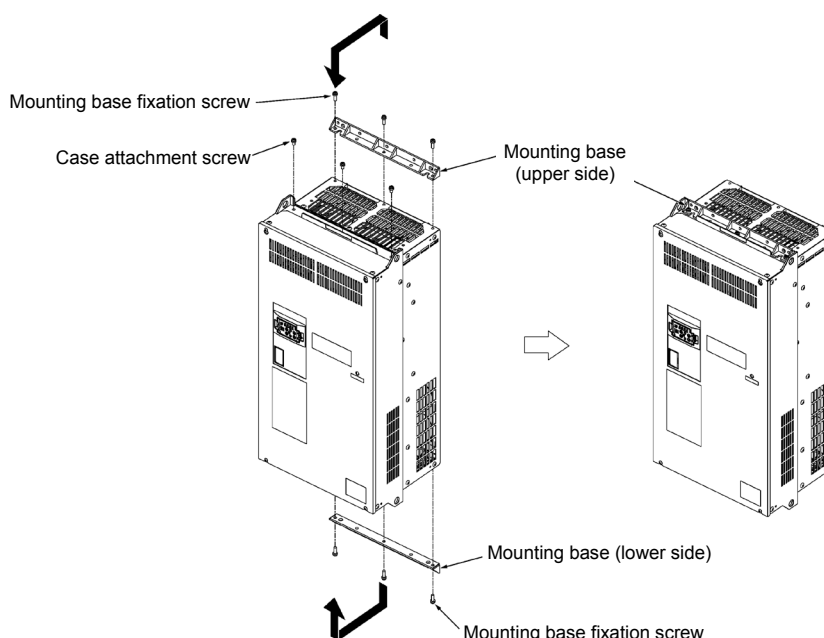

Figure 2.1-3 Method to Change the Mounting Base Positions

⚠ CAUTION

Use the specified screws in changing the mounting bases.

Risk of fire and risk of accidents exist

■ Inverter unit installation screw size

Select the bolt size, considering the thickness of the mounting feet and installation surface so that the bolt protrudes from the nut by 2 threads or more.

Inverter type	Inverter fixation screw	Tightening torque N·m (lb-in)
200V class : FRN0030/0040E2-2□ 400V class : FRN0022/0029E2-4□	M5 (4 screws)	3.5 (31.0)
200V class : FRN0056/0069E2-2□ 400V class : FRN0037E2-4□ to FRN0203E2-4□	M8 (4 screws)	13.5 (119)
400V class : FRN0240E2-4□ to FRN0415E2-4□	M12 (4 screws)	48 (425)
400V class : FRN0520E2-4□ to FRN0590E2-4□	M12 (6 screws)	48 (425)

2.2 Wiring

2.2.1 Basic connection diagram

■ Model-GA, Standard terminal block board (with CAN)

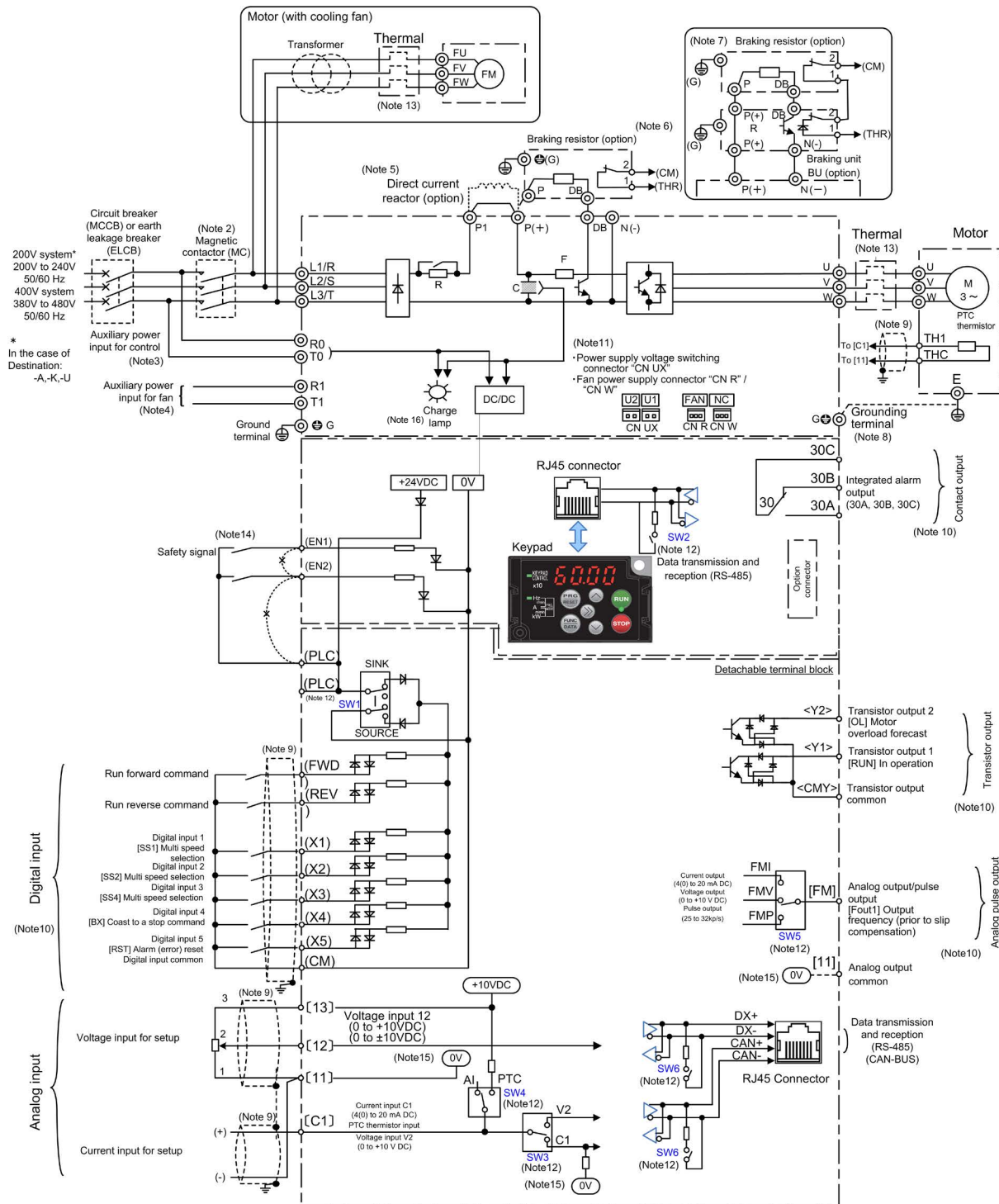

Figure 2.2-1 Standard Terminal Block Board (with CAN)

■ Model-GB/ Model-C, Standard terminal block board (without CAN, with FM2)

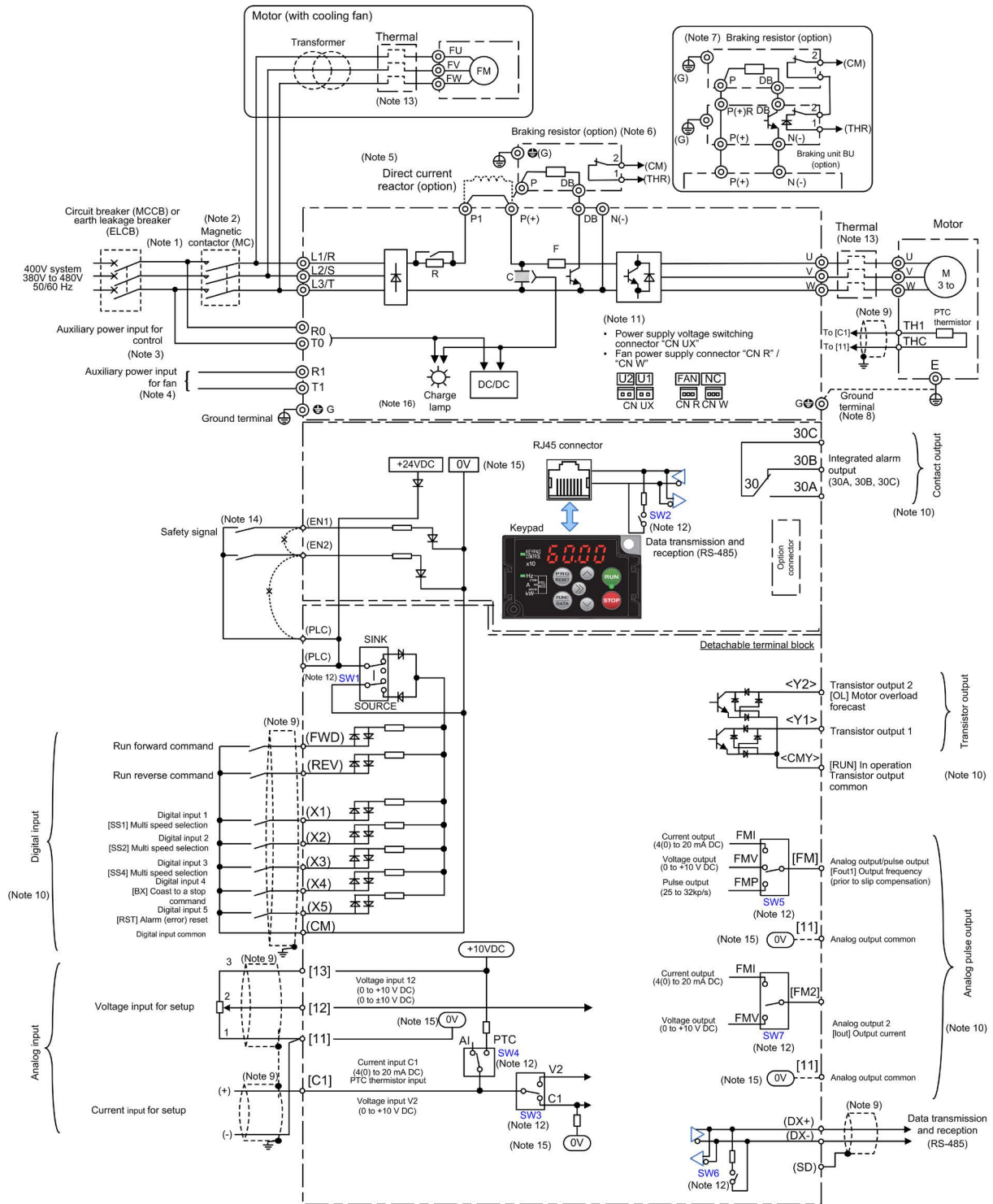

Figure 2.2-2 Standard Terminal Block Board (Without CAN, With FM2)

- (Note 1) Install recommended circuit breakers (MCCB) or residual-current-operated protective device (RCD)/ earth leakage breakers (ELCB) (with overcurrent protective function) on the inputs of each inverter (primary side) for wiring protection. Do not use breakers which exceed the recommended rated current.
- (Note 2) Install recommended magnetic contactors (MC) as necessary on each inverter as these will be used to disconnect the inverter from the power supply separately from the MCCB or RCD / the ELCB. Additionally, when installing coils such as MC or solenoid close to the inverter, connect surge absorbers in parallel.
- (Note 3) When it is desired to retain the alarm signal for the activation of the protective function even inverter main power supply is shut off, or when it is desired continuous display of the keypad, connect this terminal to the power supply. The inverter can be operated without connecting power to this terminal (applicable for types FRN0059E2■-4□/ FRN00088E2■-2□ or above)
- (Note 4) The terminal does not need to be connected. Use this terminal when operating in combination with a high power factor regenerative PWM converter (RHC series). Applicable for types FRN0203E2■-4□ or above)
- (Note 5) Remove the shorting bar between the inverter main circuit terminals P1-P(+) before connecting the direct current reactor (DCR) (option).
It must be connected in the following cases:
ND mode: Types FRN0139 E2■-4□ or above, HD/ HND mode: Types FRN0168E2■-4□ or above, HHD mode: Types FRN0203E2■-4□ or above.
Use the direct current reactor (option) when the power supply transformer capacity is above 500 kVA and the transformer capacity is over 10 times the rated capacity of the inverter, or when “thyristor load exists” in the same power system.
- (Note 6) Types FRN0011E2■-7□/FRN0115E2■-2□/ FRN0072E2■-4□ or below have built-in braking transistors, allowing direct connection of braking resistors between P(+)-DB.
- (Note 7) When connecting braking resistors to types FRN0085E2■-4□ or above, always add the braking unit (option). Connect the braking unit (option) between P(+)-N(-). Auxiliary terminals [1] and [2] have polarity. Please connect as shown in the diagram.
- (Note 8) This terminal is used for grounding the motor. Grounding the motor using this terminal is recommended in order to suppress inverter noise.
- (Note 9) Use twisted lines or shielded lines for the control signals.
Generally, the shielded line requires grounding, but when the effect of externally induced noise is large, connecting to [CM] may suppress the effect of noise. Separate the line from the main circuit wiring and do not enclose in the same duct. (Separation distance of over 10 cm is recommended.) When crossing the main circuit wiring, make the intersection perpendicular.
- (Note 10) The various functions listed for terminals[X1] to [X5](digital inputs), terminals [Y1] to [Y2](transistor output), and terminal [FM] (monitor output) show the functions assigned as factory default.
- (Note 11) These are connectors for switching the main circuit. For details, refer to “2.2.7 Switching connector (types FRN0203E2■-4□ or above)”.
- (Note 12) The slide switches on the control printed circuit board define the settings for the inverter operation. For details, refer to “2.2.8 Operating slide switches”.
- (Note 13) Make the circuit breakers (MCCB) or the magnetic contactors (MC) trip by the thermal relay auxiliary contacts (manual recovery).
- (Note 14) Shorting bars are connected between the safety function terminals [EN1], [EN2], and [PLC] as factory default. Remove the shorting bars when using this function.
- (Note 15) $\square 0V$ and $\bigcirc 0V$ are separated and insulated.
- (Note 16) Charge lamp does not exist in the inverters FRN0069E2■-2□/FRN0044E2■-4□/FRN0011E2■-7□ or below.

Route the wiring following the steps below. The descriptions assume that the inverter is already fixed to the cabinet.

2.2.2 Removal and attachment of the front cover/ terminal cover and wiring guide

⚠ CAUTION

Always remove the RS-485 communication cable from the RJ-45 connector before removing the front cover.

Risk of fire and risk of accidents exist.

(1) Types FRN0020E2-2□/ FRN0012E2-4□/ FRN0011E2-7□ or below

- 1) Loosen the screws of the terminal cover. To remove the terminal cover, put your finger in the dimple of the terminal cover and then pull it up toward you.
- 2) Pull out the wiring guide toward you.
- 3) After routing the wires, attach the wiring guide and the terminal cover reversing the steps above.

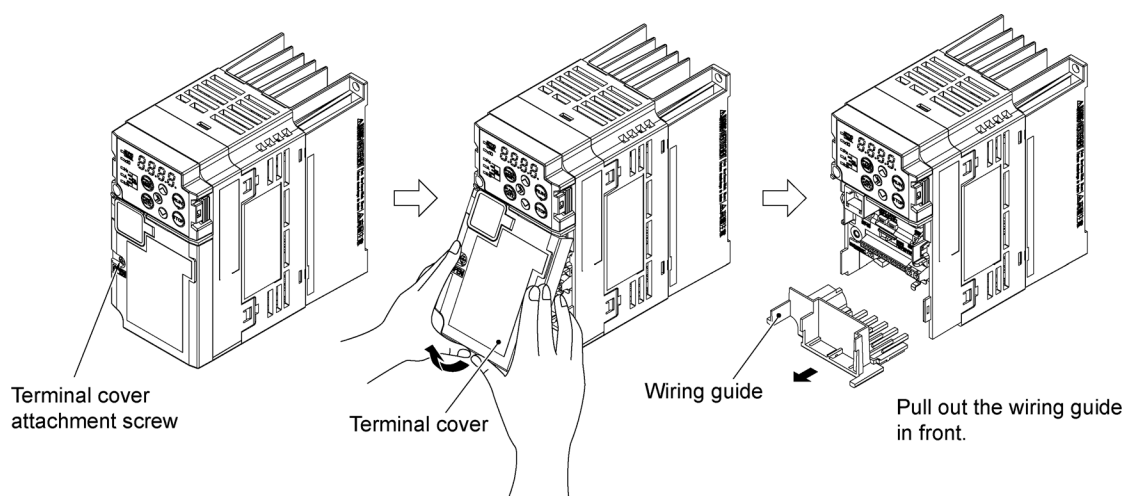

Figure 2.2-3 Removal of the Terminal Cover and the Wiring Guide (for FRN0006E2S-2□)

(2) Types FRN0030E2-2□ to FRN0069E2-2□ and FRN0022E2-4□ to FRN0044 E2-4□

- 1) Loosen the screws of the terminal cover. To remove the terminal cover, put your finger in the dimple of the terminal cover and then pull it up toward you.
- 2) Pull out the wiring guide toward you.
- 3) After routing the wires, attach the wiring guide and the terminal cover reversing the steps above.

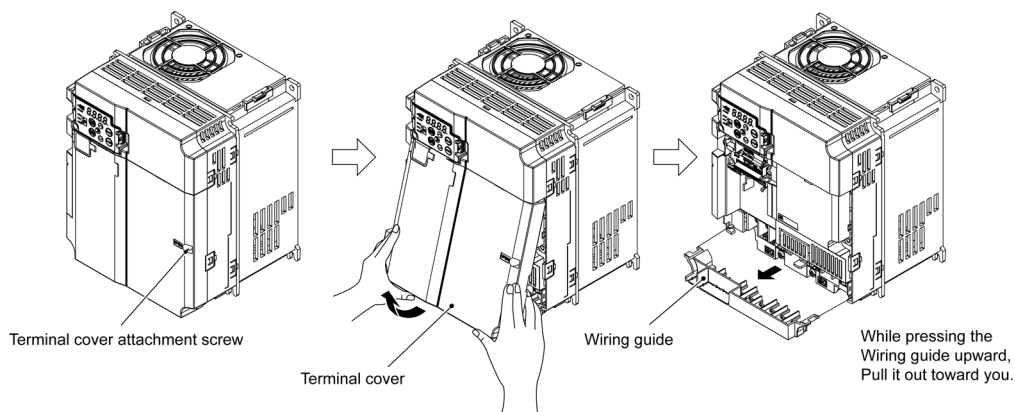

Figure 2.2-4 Removal of the Terminal Cover and the Wiring Guide (for FRN0069E2-2□)

(3) Types FRN0088E2-2□/ FRN0115E2-2□/ FRN0072E2-4□/ FRN0085E2-4□

- 1) Loosen the screws of the front cover. Hold both sides of the front cover with the hands, slide the cover downward, and pull. Then remove it to the upward direction.
- 2) Push the wiring guide upward and pull. Let the wiring guide slide and remove it.
- 3) After routing the wires, attach the wiring guide and the front cover reversing the steps above.

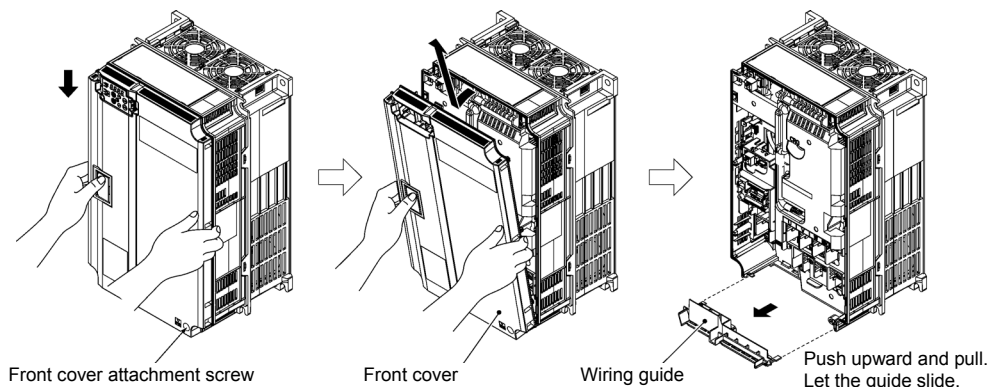

Figure 2.2-5 Removal of the Front Cover and the Wiring Guide (for FRN0072E2-4□)

(4) Types FRN0085E2-4□ or above

- 1) Loosen the screws of the front cover. Hold both sides of the front cover with the hands and slide it upward to remove.
- 2) After routing the wires, align the front cover top edge to the screw holes and attach the cover reversing the steps in Figure 2.2-6.

Tip Open the keypad case to view the control printed circuit board.

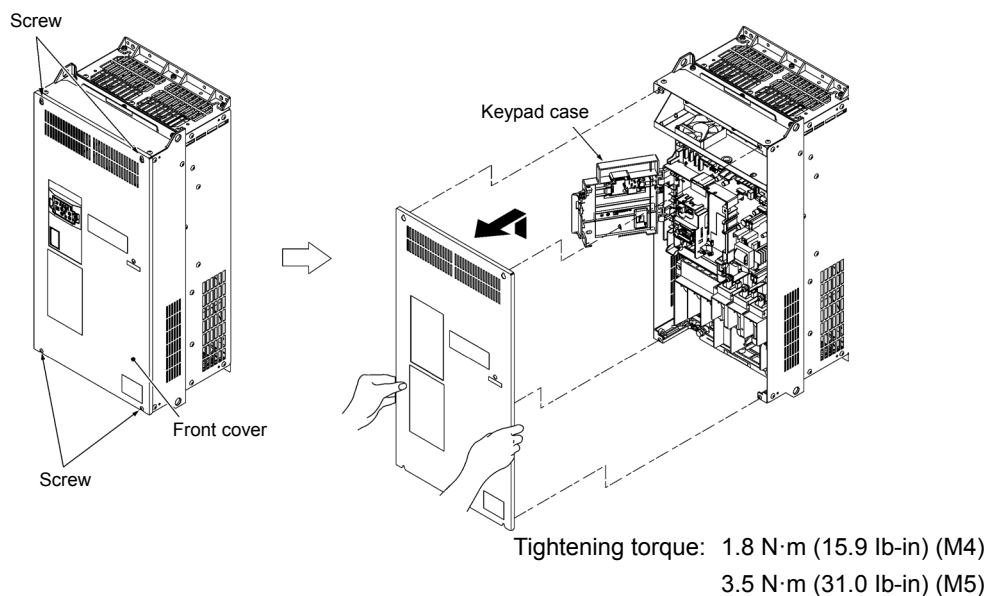
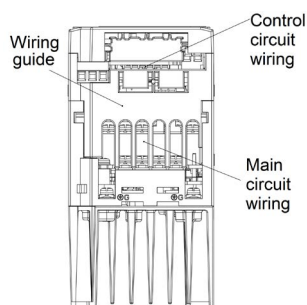

Figure 2.2-6 Removal of the front cover (for FRN0203E2-4□)

2.2.3 Precautions for wiring

Exercise caution for the following when wiring.

- (1) Confirm that the supply voltage is within the input voltage range described on the rating plate.
- (2) Always connect the power lines to the inverter main power input terminals L1/R, L2/S, L3/T (Three-phase). (The inverter will be damaged when power is applied if the power lines are connected to the wrong terminals.)
- (3) Always route the ground line to prevent accidents such as electric shock and fire and to reduce noise.
- (4) For the lines connecting to the main circuit terminals, use crimped terminals with insulating sleeves or use crimped terminals in conjunction with insulating sleeves for high connection reliability.
- (5) Separate the routing of the lines connected to the main circuit input side terminals (primary side) and the output side terminals (secondary side) and the lines connected to the control circuit terminals. The control circuit terminal lines should be routed as far as possible from the main circuit routing. Malfunction may occur due to noise.
- (6) To prevent direct contact with the main circuit live sections (such as the main circuit terminal block), route the control circuit wiring inside the inverter as bundles using cable ties.
- (7) After removing a main circuit terminal screw, always restore the terminal screw in position and tighten even if lines are not connected.
- (8) The wiring guide is used to separately route the main circuit wiring and the control circuit wiring. The main circuit wiring and the control circuit wiring can be separated. Exercise caution for the order of wiring.



Case of FRN0006E2S-2□

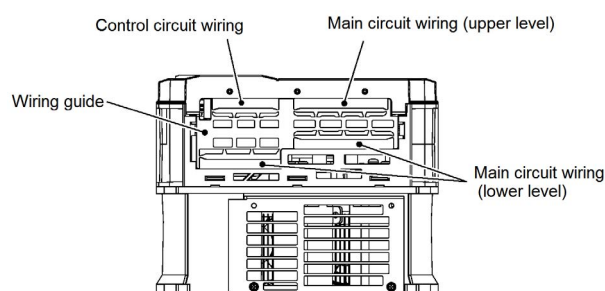

Case of FRN0072E2■-4□

■ Handling the Wiring Guide

For inverter types FRN0001 to 0115E2■-2□ and FRN0002 to 0072 E2■-4□, the wiring space may become insufficient when routing the main circuit wires, depending on the wire material used. In these cases, the relevant cut-off sections (see Figure 2.2-7, Figure 2.2-8) can be removed using a pair of nippers to secure routing space. Be warned that removing the wiring guide to accommodate the enlarged main circuit wiring will result in non-conformance to IP20 requirements.

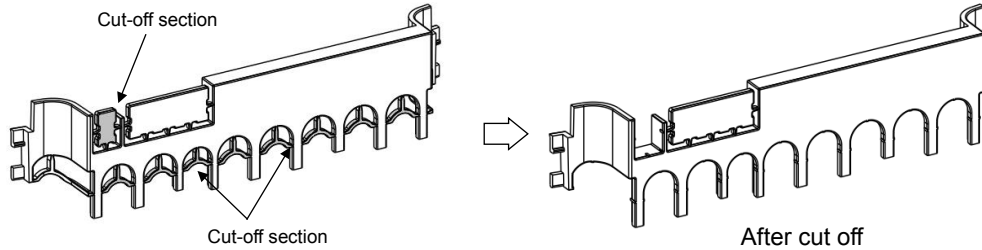

Figure 2.2-7 Wiring Guide (FRN0069E2■-2□)

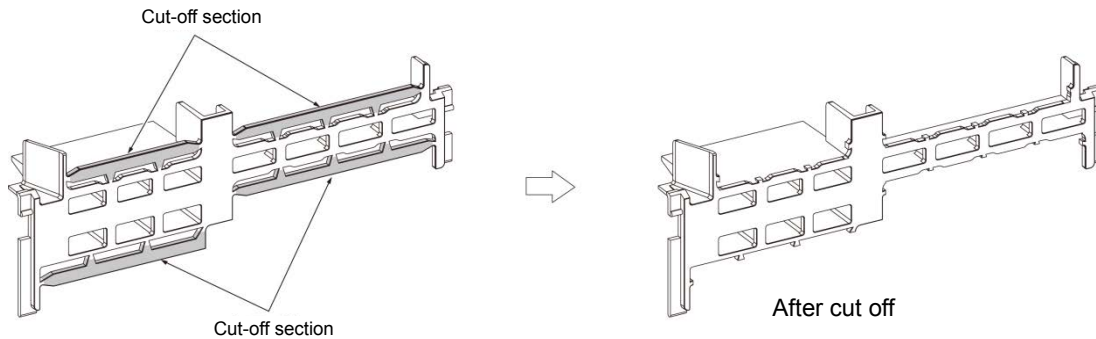
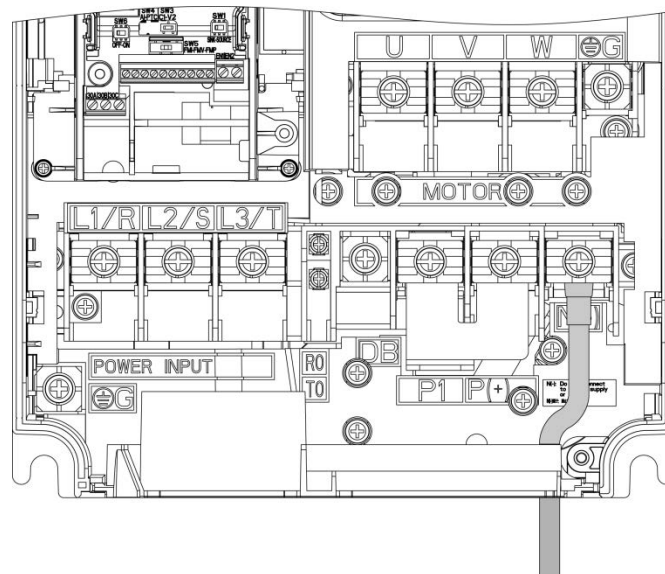

Figure 2.2-8 Wiring Guide (FRN0072E2■-4□)

- (9) Depending on the inverter capacity, straight routing of the main circuit wires from the main circuit terminal block may not be possible. In these cases, route the wires as shown in the figure below and securely attach the front cover.



2.2.4 Precautions for long wiring (between inverter and motor)

- (1) When multiple motors are connected to one inverter, the wiring length is the total of all wire lengths.
- (2) Precautions shall be taken for high frequency leak current when the wiring length from the inverter to the motor is long, in this case the high frequency current may flow through the stray capacitance between the wires with various phases. The effect may cause the inverter to become overheated, or trip due to overcurrent. Leak current may increase and the accuracy of the displayed current may not be ensured. Depending on the conditions, excessive leak current may damage the inverter. To avoid the above problems when directly connecting an inverter to a motor, keep the wiring distance 50 m (164 ft) for inverters FRN0020E2■-2□/ FRN0012E2■-4□ /FRN0011E2■-7□ or below, and below 100 m (328 ft) for inverters FRN0030E2■-2□/ FRN0022E2■-4□ or above.

To operate with longer wiring lengths than the ones above mentioned, reduce the carrier frequency or use an output circuit filter (OFL-□□□-□A).

When multiple motors are operated in parallel connection configuration (group operation), and especially when shielded cables are used in the connections, the stray capacitance to ground is large. Reduce the carrier frequency or use output circuit filters (OFL-□□□-□A).

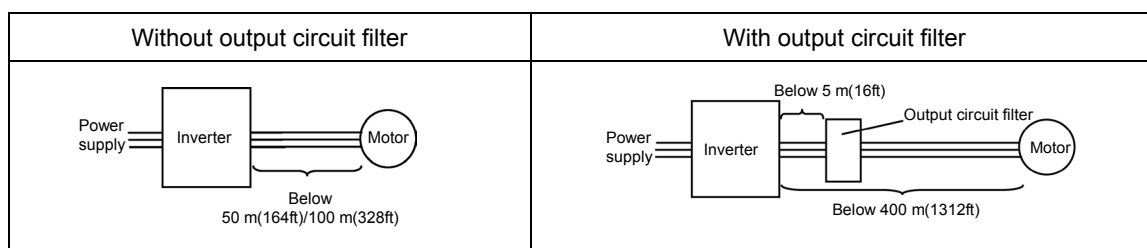

When the output circuit filter is used, the total wiring length should be below 400 m (1312ft) in case of using V/f control.

For motors with encoders, the wiring length between the inverter and motor should be below 100 m (328ft). The restriction comes from the encoder specifications. For distances beyond 100 m (328ft), insulation converters should be used. Please contact Fuji Electric when operating with wiring lengths beyond the upper limit.

- (3) Precautions on the surge voltage when driving the inverter (especially for 400 V series motor)
When motors are driven by inverters using the PWM method, the surge voltage generated by the switching of the inverter elements is added to the output voltage and is applied onto the motor terminals. Especially when the motor wiring length is long, the surge voltage can cause insulation degradation in the motor. Please perform one of the countermeasures shown below.
 - Use motor with insulation enhancement (Fuji's standard motors have insulation enhancements)
 - Connect a surge suppression unit on the motor side (SSU50/100TA-NS)
 - Connect an output circuit filter (OFL-□□□-□A) to the inverter output side (secondary side)
 - Reduce the wiring length from the inverter to the motor to less than 10 to 20 meters (33 to 66ft).
- (4) When output circuit filters are attached to the inverter or when the wiring length is long, the voltage applied to the motor will decrease due to the voltage drop caused by the filter or wiring. In these cases, current oscillation and lack of torque may occur due to insufficient voltage.

⚠ WARNING ⚠

- For each inverter, connect to the power supply via circuit breaker and earth leakage breaker (with overcurrent protective function). Use recommended circuit breakers and earth leakage breakers and do not use breakers which exceed the recommended rated current.
- Always use the specified sizes for the wires.
- Tighten terminals with the defined tightening torque.
- When multiple combinations of inverters and motors exist, do not use multi-core cables for the purpose of bundling the various wires.
- Do not install surge killers on the inverter output side (secondary side)

Risk of fire exists.

- Ground the inverter in compliance with the national or local electric code.
- Always connect the ground line to the inverter grounding terminal [⚡G]

Risk of electric shock and risk of fire exist.

- Qualified personnel should perform the wiring.
- Perform wiring after confirming that the power is shut off.

Risk of electric shock exists.

- Perform wiring only after the equipment is installed at the location.

Risk of electric shock and risk of injury exist.

- Confirm that the specifications (number of phases and the rated voltage) of the power supply input of the product match with the specifications of the power supply to be connected.
- Do not connect power supply lines to the inverter output terminals (U, V, W).

Risk of fire and risk of accidents exist.

2.2.5 Main circuit terminals

[1] Screw specifications

The specifications for the screws used in the main circuit wiring and the wire sizes are shown below. Exercise caution as the terminal position varies depending on inverter capacity. In the diagram in “[2] Terminal layout diagram (main circuit terminal)”, the two ground terminals [⊕G] are not differentiated for the input side (primary side) and the output side (secondary side).

Also, use crimped terminals with insulating sleeves compatible for main circuit or terminals with insulating tubes. The recommended wire sizes are shown depending on cabinet temperature and wire type.

Table 2.2-1 Screw Specifications (Three-phase 200V series, Basic type)

Power System	Inverter type	See item [2]	Screw specifications							
			Main circuit		Grounding		Auxiliary power input for control [R0, T0]		Auxiliary power input for fan [R1, T1]	
			Screw size (driver size)	Tightening torque N·m (lb-in)	Screw size (driver size)	Tightening torque N·m (lb-in)	Screw size	Tightening torque N·m (lb-in)	Screw size	Tightening torque N·m (lb-in)
Three-phase 200 V	FRN0001E2S-2□	Fig. a	M3.5	0.8 (7.1)	M3.5	1.2 (10.6)	—	—	—	—
	FRN0002E2S-2□									
	FRN0004E2S-2□									
	FRN0006E2S-2□									
	FRN0010E2S-2□	Fig. b	M4	1.2 (10.6)	M4	1.8 (15.9)				
	FRN0012E2S-2□									
	FRN0020E2S-2□	Fig. c								
	FRN0030E2S-2□	Fig. A	M5	3.0 (26.6)	M5	3.0 (26.6)				
	FRN0040E2S-2□									
	FRN0056E2S-2□	Fig. B	M6 (No.3)	5.8 (51.3)	M6 (No.3)	5.8 (51.3)				
	FRN0069E2S-2□									
	FRN0088E2S-2□	Fig. C	M6 (No.3)	5.8 (51.3)	M6 (No.3)	5.8 (51.3)				
FRN0115E2S-2□										

Table 2.2-2 Screw Specifications (Three-phase 200V series, EMC filter built-in type)

Power System	Inverter type	See item [2]	Screw specifications							
			Main circuit		Grounding		Auxiliary power input for control [R0, T0]		Auxiliary power input for fan [R1, T1]	
			Screw size (driver size)	Tightening torque N·m (lb-in)	Screw size (driver size)	Tightening torque N·m (lb-in)	Screw size	Tightening torque N·m (lb-in)	Screw size	Tightening torque N·m (lb-in)
Three-phase 200 V	FRN0001E2E-2□	Fig. a	M3.5	0.8 (7.1)	M3.5	1.2 (10.6)	—	—	—	—
	FRN0002E2E-2□									
	FRN0004E2E-2□									
	FRN0006E2E-2□									
	FRN0010E2E-2□	Fig. h	M4	1.2 (10.6)	M4	1.8 (15.9)				
	FRN0012E2E-2□									
	FRN0020E2E-2□									
	FRN0030E2E-2□	Fig. i	Input: M4 Other: M5	Input: 1.8(15.9) Other: 3.0(26.6)	M5	3.0 (26.6)				
	FRN0040E2E-2□									
	FRN0056E2E-2□	Fig. j	M6 (No.3)	Input: 8.1(71.7) Other: 5.8(51.3)	M6 (No.3)	5.8 (51.3)				
	FRN0069E2E-2□									
	FRN0088E2E-2□	Fig. C	M6 (No.3)	5.8 (51.3)	M6 (No.3)	5.8 (51.3)				
FRN0115E2E-2□										

Table 2.2-3 Screw Specifications (Three-phase 400V series, Basic type)

Power System	Inverter type	See item [2]	Screw specifications							
			Main circuit		Grounding		Auxiliary power input for control [R0, T0]		Auxiliary power input for fan [R1, T1]	
			Screw size (driver size)	Tightening torque N·m (lb-in)	Screw size (driver size)	Tightening torque N·m (lb-in)	Screw size	Tightening torque N·m (lb-in)	Screw size	Tightening torque N·m (lb-in)
Three-phase 400 V	FRN0002E2S-4□	Fig. b	M4	1.2 (10.6)	M4	1.8 (15.9)	-	-	-	-
	FRN0004E2S-4□									
	FRN0006E2S-4□									
	FRN0007E2S-4□									
	FRN0012E2S-4□	Fig. c	M5	3.0 (26.6)	M5	3.0 (26.6)				
	FRN0022E2S-4□									
	FRN0029E2S-4□	Fig. A	M6 (No. 3)	5.8 (51.3)	M6 (No.3)	5.8 (51.3)				
	FRN0037E2S-4□									
	FRN0044E2S-4□	Fig. B	M6 (No. 3)	5.8 (51.3)	M6 (No.3)	5.8 (51.3)				
	FRN0059E2S-4□									
	FRN0072E2S-4□	Fig. C	M8	13.5 (119)	M8	13.5 (119)				
	FRN0085E2S-4□									
	FRN0105E2S-4□	Fig. D	M10	27 (239)	M10	27 (239)				
	FRN0139E2S-4□									
	FRN0168E2S-4□									
	FRN0203E2S-4□									
	FRN0240E2S-4□	Fig. E	M12	48 (425)	M10	27 (239)				
	FRN0290E2S-4□									
FRN0361E2S-4□	Fig. F	M3.5	1.2 (10.6)	M3.5	1.2 (10.6)					
FRN0415E2S-4□										
FRN0520E2S-4□	Fig. G	M3.5	1.2 (10.6)	M3.5	1.2 (10.6)					
FRN0590E2S-4□										
	Fig. H									

Table 2.2-4 Screw Specifications (Three-phase 400V series, EMC filter built-in type)

Power System	Inverter type	See item [2]	Screw specifications							
			Main circuit		Grounding		Auxiliary power input for control [R0, T0]		Auxiliary power input for fan [R1, T1]	
			Screw size (driver size)	Tightening torque N·m (lb-in)	Screw size (driver size)	Tightening torque N·m (lb-in)	Screw size	Tightening torque N·m (lb-in)	Screw size	Tightening torque N·m (lb-in)
Three-phase 400 V	FRN0002E2E-4□	Fig. g	M4	1.2 (10.6)	M4	1.8 (15.9)	-	-	-	-
	FRN0004E2E-4□									
	FRN0006E2E-4□									
	FRN0007E2E-4□	Fig. h	M4	1.2 (10.6)	M4	1.8 (15.9)				
	FRN0012E2E-4□									
	FRN0022E2E-4□	Fig. i	Input M4 Output M5	Input: 1.8(15.9) Other: 3.0(26.6)	M5	3.0 (26.6)				
	FRN0029E2E-4□									
	FRN0037E2E-4□	Fig. j	Input M4 Output M6	Input: 1.8(15.9) Other: 5.8(51.3)	M6 (No.3)	5.8 (51.3)				
	FRN0044E2E-4□									
	FRN0059E2E-4□	Fig. C	M6 (No. 3)	5.8 (51.3)	M6 (No.3)	5.8 (51.3)				
	FRN0072E2E-4□									
	FRN0085E2E-4□	Fig. D	M8	13.5 (119)	M8	13.5 (119)				
	FRN0105E2E-4□									
	FRN0139E2E-4□									
	FRN0168E2E-4□									
	FRN0203E2E-4□	Fig. E	M10	27 (239)	M10	27 (239)				
	FRN0240E2E-4□									
	FRN0290E2E-4□	Fig. F	M3.5	1.2 (10.6)	M3.5	1.2 (10.6)				
FRN0361E2E-4□										
FRN0415E2E-4□	Fig. G	M3.5	1.2 (10.6)	M3.5	1.2 (10.6)					
FRN0520E2E-4□										
FRN0590E2E-4□	Fig. H									

Table 2.2-5 Screw Specifications (Single-phase 200V series, Basic type)

Power System	Inverter type	See item [2]	Screw specifications							
			Main circuit		Grounding		Auxiliary power input for control [R0, T0]		Auxiliary power input for fan [R1, T1]	
			Screw size (driver size)	Tightening torque N·m (lb-in)	Screw size (driver size)	Tightening torque N·m (lb-in)	Screw size	Tightening torque N·m (lb-in)	Screw size	Tightening torque N·m (lb-in)
Single-phase 200 V	FRN0001E2S-7□	Fig. k	M3.5	0.8 (7.1)	M3.5	1.2 (10.6)	-	-	-	-
	FRN0002E2S-7□									
	FRN0003E2S-7□									
	FRN0005E2S-7□									
	FRN0008E2S-7□	Fig. l	M4	1.2 (10.6)	M4	1.8 (15.9)				
	FRN0011E2S-7□	Fig. m								

Table 2.2-6 Screw Specifications (Single-phase 200V series, EMC filter built-in type)

Power System	Inverter type	See item [2]	Screw specifications							
			Main circuit		Grounding		Auxiliary power input for control [R0, T0]		Auxiliary power input for fan [R1, T1]	
			Screw size (driver size)	Tightening torque N·m (lb-in)	Screw size (driver size)	Tightening torque N·m (lb-in)	Screw size	Tightening torque N·m (lb-in)	Screw size	Tightening torque N·m (lb-in)
Single-phase 200 V	FRN0001E2E-7□	Fig. k	M3.5	0.8 (7.1)	M3.5	1.2 (10.6)	-	-	-	-
	FRN0002E2E-7□									
	FRN0003E2E-7□									
	FRN0005E2E-7□	Fig. n	M4	1.2 (10.6)	M4	1.8 (15.9)				
	FRN0008E2E-7□	Fig. h								
	FRN0011E2E-7□									

[2] Terminal layout diagram (main circuit terminal)

Figure A

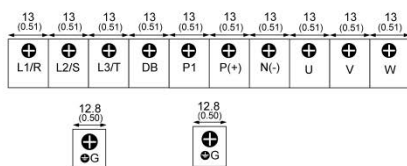

Figure B

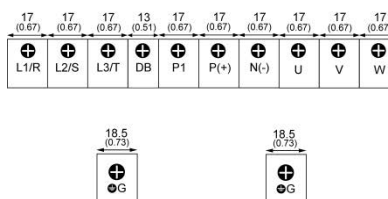

Figure C

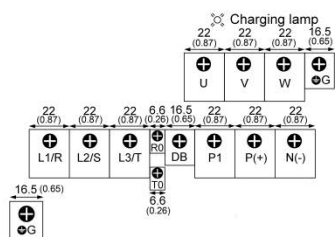

Figure D

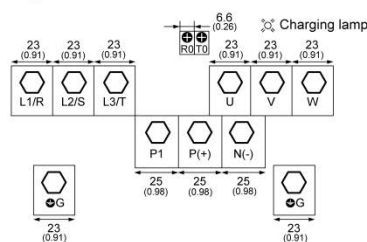

Figure E / Figure F

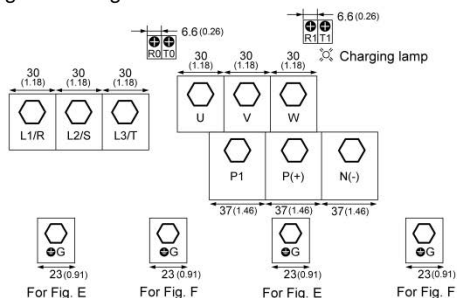
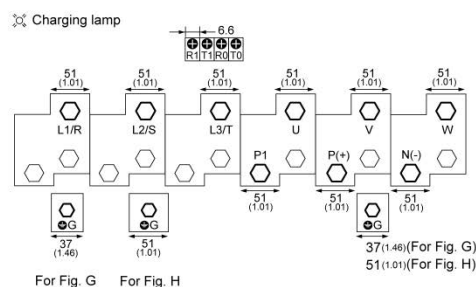

Figure G / Figure H



⚠ WARNING ⚠

The following terminals will have high voltage when power is ON.

Main circuit: L1/R, L2/S, L3/T, L1/L, L2/N, P1, P(+), N(-), DB, U, V, W, R0, T0, R1, T1

Insulation level

Main circuit - Casing : Basic insulation (overvoltage category III, degree of contamination 2)

Main circuit - Control circuit : Enhanced insulation (overvoltage category III, degree of contamination 2)

Risk of electric shock exists

Figure a

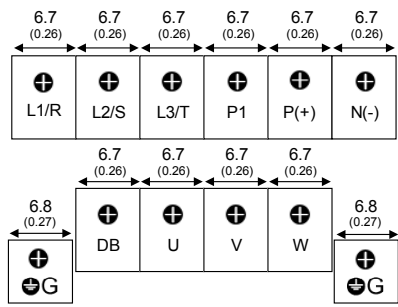

Figure b

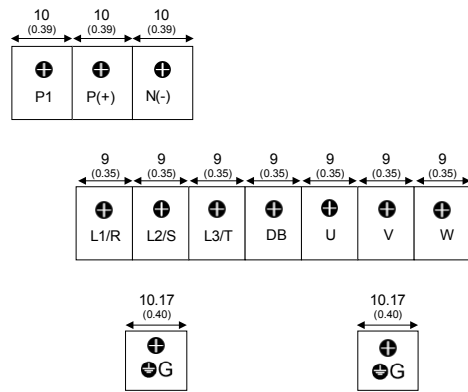

Figure c

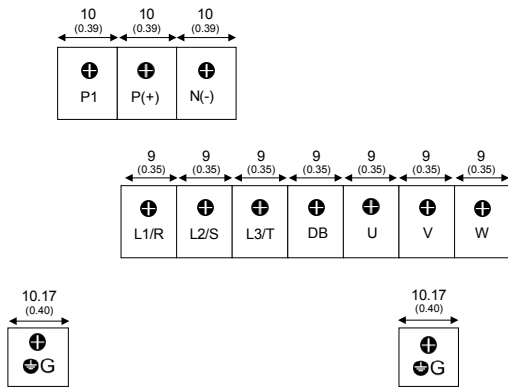

Figure i

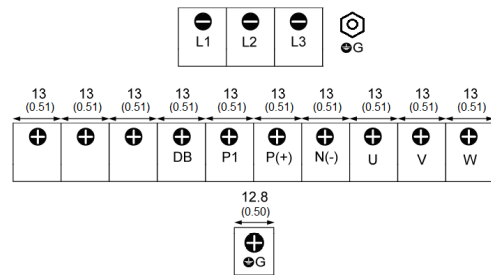

Figure j

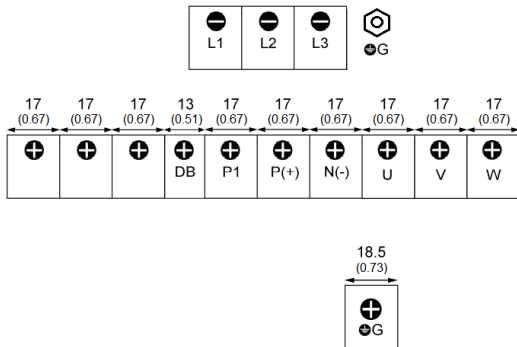

Figure k

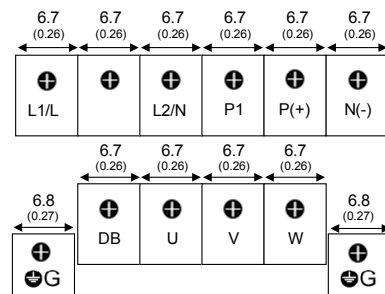

Figure l

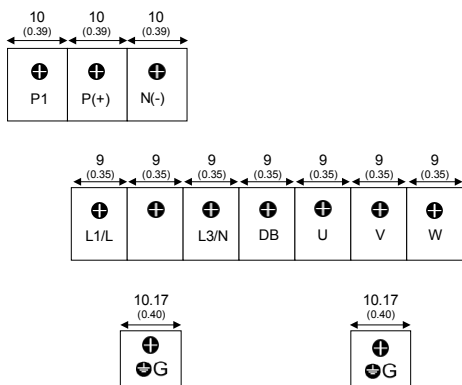
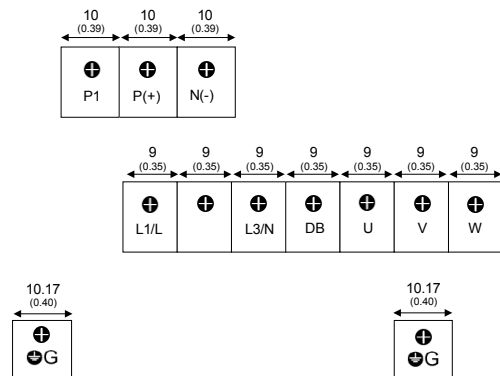

Figure m



For the figure g / h / n, please contact Fuji Electric.

[3] Recommended wire size (main circuit terminals)

The following wires are recommended unless special requirements exist.

■ **600 V vinyl insulation wire (IV wire)**

This wire is used in circuits except the inverter control circuit. The wire is difficult to twist and is not recommended for inverter control circuit. The maximum allowable temperature for the insulated wire is 60°C.

■ **600 V type 2 vinyl insulation wire or 600 V polyethylene insulation wire (HIV wire)**

In comparison to the IV wire, this wire is smaller, more flexible, and the maximum allowable temperature for the insulated wire is 75°C (higher), making it suitable for both the inverter main circuit and control circuit. However, the wiring distance should be short and the wire must be twisted for use in the inverter control circuit.

■ **600 V cross-linked polyethylene insulation wire (FSLC wire)**

This wire is used mainly in the main circuit and the grounding circuits. The size is even smaller than the IV wire or the HIV wire and also more flexible. Due to these features, the wire is used to reduce the area occupied by wiring and to improve work efficiency in high temperature areas. The maximum allowable temperature for the insulated wire is 90°C. As a reference, Furukawa Electric Co., Ltd. produces Boardlex which satisfies these requirements.

■ **Shielded-Twisted cables for internal wiring of electronic/electric instruments**

This product is used in inverter control circuits. Use this wire with high shielding effect when risk of exposure to or effect of radiated noise and induced noise exists. Always use this wire when the wiring distance is long, even within the cabinet. Furukawa Electric's BEAMEX S shielded cables XEBV or XEWV satisfy these requirements.

Table 2.2-7 Recommended Wire Sizes (Common Terminals)

Common terminals	Recommended wire size (mm ²) [AWG]	Remarks
Auxiliary power input terminals for control circuit R0, T0	2.0 [14]	FRN0088E2■-2□ or above FRN0059E2■-4□ or above
Auxiliary power input terminals for fan R1, T1	2.0 [14]	FRN0203E2■-4□ or above

Refer to Appendix G-3 to conform the wire sizes to the UL Standards and Canadian Standards (cUL Certification).

(1) Wire sizes conforming to low voltage directive in Europe

Table 2.2-8 Recommended Wire Sizes, conforming to low voltage directive in Europe

ND Mode, Conforming to low voltage directive in Europe

Power System	Std Applicable Motor (kW)	Inverter type	Recommended wire size (mm ²)						
			Main power supply input [L1/R, L2/S, L3/T]		Ground terminal [G]		Inverter output [U, V, W]	For DC reactor connection [P1, P(+)]	For braking resistor connection [P(+), DB]
			With DC reactor	Without DC reactor	With DC reactor	Without DC reactor			
Three-phase 400 V	0.75	FRN0002E2■-4□	2.5	2.5	2.5	2.5	2.5	2.5	2.5
	1.5	FRN0004E2■-4□	2.5	2.5	2.5	2.5	2.5	2.5	2.5
	2.2	FRN0006E2■-4□	2.5	2.5	2.5	2.5	2.5	2.5	2.5
	3.0	FRN0007E2■-4□	2.5	2.5	2.5	2.5	2.5	2.5	2.5
	5.5	FRN0012E2■-4□	2.5	2.5	2.5	2.5	2.5	2.5	2.5
	11	FRN0022E2■-4□	4	6	4	6	4	4	2.5
	15	FRN0029E2■-4□	6	10	6	10	6	6	2.5
	18.5	FRN0037E2■-4□	6	16	6	16	10	10	2.5
	22	FRN0044E2■-4□	10	16	10	16	10	16	2.5
	30	FRN0059E2■-4□	16	25	16	16	16	25	2.5
	37	FRN0072E2■-4□	25	35	16	16	25	25	2.5
	45	FRN0085E2■-4□	25	50	16	25	35	35	-
	55	FRN0105E2■-4□	35	70	16	35	50	50	-
	75	FRN0139E2■-4□	70	-	35	-	70	95	-
	90	FRN0168E2■-4□	95	-	50	-	95	120	-
	110	FRN0203E2■-4□	120	-	70	-	120	150	-
	132	FRN0240E2■-4□	150	-	95	-	150	95×2	-
	160	FRN0290E2■-4□	95×2	-	95	-	95×2	120×2	-
200	FRN0361E2■-4□	300	-	150	-	300	150×2	-	
220	FRN0415E2■-4□	300	-	150	-	150×2	185×2	-	
280	FRN0520E2■-4□	185×2	-	185	-	240×2	300×2	-	
315	FRN0590E2■-4□	240×2	-	240	-	240×2	300×2	-	

HD Mode, Conforming to low voltage directive in Europe

Power System	Std Applicable Motor (kW)	Inverter type	Recommended wire size (mm ²)						
			Main power supply input [L1/R, L2/S, L3/T]		Ground terminal [G]		Inverter output [U, V, W]	For DC reactor connection [P1, P(+)]	For braking resistor connection [P(+), DB]
			With DC reactor	Without DC reactor	With DC reactor	Without DC reactor			
Three-phase 400 V	0.75	FRN0002E2■-4□	2.5	2.5	2.5	2.5	2.5	2.5	2.5
	1.1	FRN0004E2■-4□	2.5	2.5	2.5	2.5	2.5	2.5	2.5
	2.2	FRN0006E2■-4□	2.5	2.5	2.5	2.5	2.5	2.5	2.5
	3.0	FRN0007E2■-4□	2.5	2.5	2.5	2.5	2.5	2.5	2.5
	5.5	FRN0012E2■-4□	2.5	2.5	2.5	2.5	2.5	2.5	2.5
	7.5	FRN0022E2■-4□	2.5	4	2.5	4	2.5	2.5	2.5
	11	FRN0029E2■-4□	4	6	4	6	4	4	2.5
	15	FRN0037E2■-4□	6	10	6	10	6	6	2.5
	18.5	FRN0044E2■-4□	6	16	6	16	10	10	2.5
	22	FRN0059E2■-4□	10	16	10	16	10	16	2.5
	30	FRN0072E2■-4□	16	25	16	16	16	25	2.5
	37	FRN0085E2■-4□	25	35	16	16	25	25	-
	45	FRN0105E2■-4□	25	50	16	25	35	35	-
	55	FRN0139E2■-4□	35	70	16	35	50	50	-
	75	FRN0168E2■-4□	70	-	35	-	70	95	-
	90	FRN0203E2■-4□	95	-	50	-	95	120	-
	110	FRN0240E2■-4□	120	-	70	-	120	150	-
	132	FRN0290E2■-4□	150	-	95	-	150	95×2	-
160	FRN0361E2■-4□	185	-	95	-	240	300	-	
200	FRN0415E2■-4□	300	-	150	-	300	150×2	-	
220	FRN0520E2■-4□	300	-	150	-	150×2	185×2	-	
250	FRN0590E2■-4□	185×2	-	185	-	185×2	240×2	-	

The recommended wire sizes for the main circuit terminals assume using 70°C 600 V PVC wire at 40°C ambient temperature.

Table 2.2-9 Recommended Wire Sizes, conforming to low voltage directive in Europe (continued)

HND Mode, Conforming to low voltage directive in Europe

Power System	Std Applicable Motor (kW)	Inverter type	Recommended wire size (mm ²)						
			Main power supply input [L1/R, L2/S, L3/T]		Ground terminal [G]		Inverter output [U, V, W]	For DC reactor connection [P1, P(+)]	For braking resistor connection [P(+), DB]
			With DC reactor	Without DC reactor	With DC reactor	Without DC reactor			
Three-phase 400 V	0.75	FRN0002E2-4□	2.5	2.5	2.5	2.5	2.5	2.5	2.5
	1.1	FRN0004E2-4□	2.5	2.5	2.5	2.5	2.5	2.5	2.5
	2.2	FRN0006E2-4□	2.5	2.5	2.5	2.5	2.5	2.5	2.5
	3.0	FRN0007E2-4□ ^{*10}	2.5	2.5	2.5	2.5	2.5	2.5	2.5
	5.5	FRN0012E2-4□ ^{*10}	2.5	2.5	2.5	2.5	2.5	2.5	2.5
	7.5	FRN0022E2-4□	2.5	4	2.5	4	2.5	2.5	2.5
	11	FRN0029E2-4□	4	6	4	6	4	4	2.5
	15	FRN0037E2-4□	6	10	6	16	6	6	2.5
	18.5	FRN0044E2-4□	6	16	10	16	10	10	2.5
	22	FRN0059E2-4□	10	16	10	16	10	16	2.5
	30	FRN0072E2-4□	16	25	16	16	16	25	2.5
	37	FRN0085E2-4□	25	35	16	16	25	25	-
	45	FRN0105E2-4□	25	50	16	25	35	35	-
	55	FRN0139E2-4□	35	70	16	35	50	50	-
	75	FRN0168E2-4□	70	-	35	-	70	95	-
	90	FRN0203E2-4□	95	-	50	-	95	120	-
	110	FRN0240E2-4□	120	-	70	-	120	150	-
	132	FRN0290E2-4□	150	-	95	-	150	95×2	-
160	FRN0361E2-4□	185	-	95	-	240	300	-	
200	FRN0415E2-4□	300	-	150	-	300	150×2	-	
220	FRN0520E2-4□	300	-	150	-	150×2	185×2	-	
280	FRN0590E2-4□	185×2	-	185	-	240×2	300×2	-	

HND Mode, Conforming to low voltage directive in Europe

Power System	Std Applicable Motor (kW)	Inverter type	Recommended wire size (mm ²)						
			Main power supply input [L1/R, L2/S, L3/T]		Ground terminal [G]		Inverter output [U, V, W]	For DC reactor connection [P1, P(+)]	For braking resistor connection [P(+), DB]
			With DC reactor	Without DC reactor	With DC reactor	Without DC reactor			
Three-phase 400 V	0.4	FRN0002E2-4□	2.5	2.5	2.5	2.5	2.5	2.5	2.5
	0.75	FRN0004E2-4□	2.5	2.5	2.5	2.5	2.5	2.5	2.5
	1.5	FRN0006E2-4□	2.5	2.5	2.5	2.5	2.5	2.5	2.5
	2.2	FRN0007E2-4□	2.5	2.5	2.5	2.5	2.5	2.5	2.5
	3.7	FRN0012E2-4□	2.5	2.5	2.5	2.5	2.5	2.5	2.5
	5.5	FRN0022E2-4□	2.5	2.5	2.5	2.5	2.5	2.5	2.5
	7.5	FRN0029E2-4□	2.5	4	2.5	4	2.5	2.5	2.5
	11	FRN0037E2-4□	4	6	4	6	4	4	2.5
	15	FRN0044E2-4□	6	10	6	10	6	6	2.5
	18.5	FRN0059E2-4□	6	16	10	16	10	10	2.5
	22	FRN0072E2-4□	10	16	10	16	10	16	2.5
	30	FRN0085E2-4□	16	25	16	16	16	25	-
	37	FRN0105E2-4□	25	35	16	16	25	25	-
	45	FRN0139E2-4□	25	50	16	25	35	35	-
	55	FRN0168E2-4□	35	70	16	35	50	50	-
	75	FRN0203E2-4□	70	-	35	-	70	95	-
	90	FRN0240E2-4□	95	-	50	-	95	120	-
	110	FRN0290E2-4□	120	-	70	-	120	150	-
132	FRN0361E2-4□	150	-	95	-	150	185	-	
160	FRN0415E2-4□	185	-	95	-	240	300	-	
200	FRN0520E2-4□	300	-	150	-	300	150×2	-	
220	FRN0590E2-4□	300	-	150	-	150×2	185×2	-	
Single-phase 200V	0.1	FRN0001E2-7□	2.5	2.5	2.5	2.5	2.5	2.5	2.5
	0.2	FRN0002E2-7□	2.5	2.5	2.5	2.5	2.5	2.5	2.5
	0.4	FRN0003E2-7□	2.5	2.5	2.5	2.5	2.5	2.5	2.5
	0.75	FRN0005E2-7□	2.5	2.5	2.5	2.5	2.5	2.5	2.5
	1.5	FRN0008E2-7□	2.5	2.5	2.5	2.5	2.5	2.5	2.5
	2.2	FRN0011E2-7□	2.5	4	2.5	4	2.5	2.5	2.5

The recommended wire sizes for the main circuit terminals assume using 70°C 600 V PVC wire at 40°C ambient temperature.

*10 ND-spec.

(2) Recommended Wire Sizes

1) Ambient temperature: Below 40°C, Wire type: 60°C wire

Table 2.2-10 Recommended wire size, Ambient temperature: Below 40°C, Wire type: 60°C wire

ND Mode, Ambient temperature: Below 40°C, Wire type: 60°C wire

Power System	Std Applicable Motor (kW)	Inverter type	Recommended wire size (mm ²)					
			Main power supply input [L1/R, L2/S, L3/T]		Ground terminal [ⓍG]	Inverter output [U, V, W]	For DC reactor connection [P1, P(+)]	For braking resistor connection [P(+), DB]
			With DC reactor	Without DC reactor				
Three-phase 400 V	0.75	FRN0002E2■-4□	2	2	2	2	2	2
	1.5	FRN0004E2■-4□	2	2	2	2	2	2
	2.2	FRN0006E2■-4□	2	2	2	2	2	2
	3.0	FRN0007E2■-4□	2	2	2	2	2	2
	5.5	FRN0012E2■-4□	2	2	2	2	2	2
	11	FRN0022E2■-4□	2	5.5	3.5	2	3.5	2
	15	FRN0029E2■-4□	3.5	8	5.5	3.5	5.5	2
	18.5	FRN0037E2■-4□	5.5	14	5.5	5.5	8	2
	22	FRN0044E2■-4□	8	14	5.5	8	14	2
	30	FRN0059E2■-4□	14	22	8 ^{*1}	14	14	2
	37	FRN0072E2■-4□	14	38	8 ^{*1}	14	22	2
	45	FRN0085E2■-4□	22	38	8	22	38	-
	55	FRN0105E2■-4□	38	60	14	38	38	-
	75	FRN0139E2■-4□	60	-	14	60	60	-
	90	FRN0168E2■-4□	60	-	14	60	100 ^{*2}	-
	110	FRN0203E2■-4□	100	-	22	100	-	-
	132	FRN0240E2■-4□	100	-	22	100	-	-
	160	FRN0290E2■-4□	-	-	22	-	-	-
	200	FRN0361E2■-4□	-	-	38	-	-	-
220	FRN0415E2■-4□	-	-	38	-	-	-	
280	FRN0520E2■-4□	-	-	38	-	-	-	
315	FRN0590E2■-4□	-	-	60	-	-	-	

HD Mode, Ambient temperature: Below 40°C, Wire type: 60°C wire

Power System	Std Applicable Motor (kW)	Inverter type	Recommended wire size (mm ²)					
			Main power supply input [L1/R, L2/S, L3/T]		Ground terminal [ⓍG]	Inverter output [U, V, W]	For DC reactor connection [P1, P(+)]	For braking resistor connection [P(+), DB]
			With DC reactor	Without DC reactor				
Three-phase 400 V	0.75	FRN0002E2■-4□	2	2	2	2	2	2
	1.1	FRN0004E2■-4□	2	2	2	2	2	2
	2.2	FRN0006E2■-4□	2	2	2	2	2	2
	3.0	FRN0007E2■-4□	2	2	2	2	2	2
	5.5	FRN0012E2■-4□	2	2	2	2	2	2
	7.5	FRN0022E2■-4□	2	3.5	2	2	2	2
	11	FRN0029E2■-4□	2	5.5	3.5	3.5	3.5	2
	15	FRN0037E2■-4□	3.5	8	5.5	5.5	5.5	2
	18.5	FRN0044E2■-4□	5.5	14	5.5	5.5	8	2
	22	FRN0059E2■-4□	8 ^{*1}	14	5.5	8 ^{*1}	14	2
	30	FRN0072E2■-4□	14	22	8 ^{*1}	14	14	2
	37	FRN0085E2■-4□	14	38	8	22	22	-
	45	FRN0105E2■-4□	22	38	8	22	38	-
	55	FRN0139E2■-4□	38	60	14	38	38	-
	75	FRN0168E2■-4□	60	-	14	60	60	-
	90	FRN0203E2■-4□	60	-	14	60	100	-
	110	FRN0240E2■-4□	100	-	22	100	-	-
	132	FRN0290E2■-4□	100	-	22	-	-	-
	160	FRN0361E2■-4□	-	-	22	-	-	-
200	FRN0415E2■-4□	-	-	38	-	-	-	
220	FRN0520E2■-4□	-	-	38	-	-	-	
250	FRN0590E2■-4□	-	-	38	-	-	-	

The recommended wire sizes for the main circuit terminals assume using 60°C IV wire.

*1 For compatible crimped terminals, please use model 8-L6 by JST Mfg. Co., Ltd. or equivalent.

*2 For compatible crimped terminals, please use model CB100-S8 by JST Mfg. Co., Ltd. or equivalent.

Table 2.2-11 Recommended wire sizes, Ambient temperature : Below 40°C, Wire type: 60°C wire

HND Mode, Ambient temperature: Below 40°C, Wire type: 60°C wire

Power System	Std Applicable Motor (kW)	Inverter type	Recommended wire size (mm ²)					
			Main power supply input [L1/R, L2/S, L3/T]		Ground terminal [G]	Inverter output [U, V, W]	For DC reactor connection [P1, P(+)]	For braking resistor connection [P(+), DB]
			With DC reactor	Without DC reactor				
Three-phase 200 V	0.2	FRN0001E2-2□	2	2	2	2	2	2
	0.4	FRN0002E2-2□	2	2	2	2	2	2
	0.75	FRN0004E2-2□	2	2	2	2	2	2
	1.1	FRN0006E2-2□	2	2	2	2	2	2
	2.2	FRN0010E2-2□	2	2	2	2	2	2
	3.0	FRN0012E2-2□ ^{*10}	2	2	2	2	2	2
	5.5	FRN0020E2-2□ ^{*10}	2	5.5	3.5	2	3.5	2
	7.5	FRN0030E2-2□	3.5	8	5.5	3.5	5.5	2
	11	FRN0040E2-2□	8	14	5.5	5.5	14	2
	15	FRN0056E2-2□	14	22	5.5	14	14	2
	18.5	FRN0069E2-2□	14	38	8	14	22	2
	22	FRN0088E2-2□	22	38 ^{*7}	8	22	38 ^{*7}	2
30	FRN0115E2-2□	38 ^{*7}	60 ^{*8}	14	38 ^{*7}	60 ^{*8}	2	
Three-phase 400 V	0.75	FRN0002E2-4□	2	2	2	2	2	2
	1.1	FRN0004E2-4□	2	2	2	2	2	2
	2.2	FRN0006E2-4□	2	2	2	2	2	2
	3.0	FRN0007E2-4□ ^{*10}	2	2	2	2	2	2
	5.5	FRN0012E2-4□ ^{*10}	2	2	2	2	2	2
	7.5	FRN0022E2-4□	2	3.5	2	2	2	2
	11	FRN0029E2-4□	2	5.5	3.5	3.5	3.5	2
	15	FRN0037E2-4□	3.5	8	3.5	5.5	5.5	2
	18.5	FRN0044E2-4□	8	14	5.5	8	8	2
	22	FRN0059E2-4□	8 ^{*1}	14	5.5	8 ^{*1}	14	2
	30	FRN0072E2-4□	14	22	8 ^{*1}	14	14	2
	37	FRN0085E2-4□	14	38	8	22	22	-
	45	FRN0105E2-4□	22	38	8	22	38	-
	55	FRN0139E2-4□	38	60	14	38	38	-
	75	FRN0168E2-4□	60	-	14	60	60	-
	90	FRN0203E2-4□	60	-	14	60	100	-
	110	FRN0240E2-4□	100	-	22	100	-	-
132	FRN0290E2-4□	100	-	22	-	-	-	
160	FRN0361E2-4□	-	-	22	-	-	-	
200	FRN0415E2-4□	-	-	38	-	-	-	
220	FRN0520E2-4□	-	-	38	-	-	-	
280	FRN0590E2-4□	-	-	38	-	-	-	

The recommended wire sizes for the main circuit terminals assume using 60°C IV wire.

- *1 For compatible crimped terminals, please use model 8-L6 by JST Mfg. Co., Ltd. or equivalent.
- *2 For compatible crimped terminals, please use model CB100-S8 by JST Mfg. Co., Ltd. or equivalent.
- *7 For compatible crimped terminals, please use model 38-6 by JST Mfg. Co., Ltd. or equivalent.
- *8 For compatible crimped terminals, please use model 60-6 by JST Mfg. Co., Ltd. or equivalent.
- *10 ND-spec.

Table 2.2-12 Recommended wire sizes, Ambient temperature : Below 40°C, Wire type: 60°C wire (continued)

HHD Mode, Ambient temperature: Below 40°C, Wire type: 60°C wire

Power System	Std Applicable Motor (kW)	Inverter type	Recommended wire size (mm ²)					
			Main power supply input [L1/R, L2/S, L3/T]		Ground terminal [⊕G]	Inverter output [U, V, W]	For DC reactor connection [P1, P(+)]	For braking resistor connection [P(+), DB]
			With DC reactor	Without DC reactor				
Three-phase 200 V	0.1	FRN0001E2-2□	2	2	2	2	2	2
	0.2	FRN0002E2-2□	2	2	2	2	2	2
	0.4	FRN0004E2-2□	2	2	2	2	2	2
	0.75	FRN0006E2-2□	2	2	2	2	2	2
	1.5	FRN0010E2-2□	2	2	2	2	2	2
	2.2	FRN0012E2-2□	2	2	2	2	2	2
	3.7	FRN0020E2-2□	2	3.5	2	2	2	2
	5.5	FRN0030E2-2□	2	5.5	3.5	3.5	3.5	2
	7.5	FRN0040E2-2□	3.5	8	5.5	5.5	5.5	2
	11	FRN0056E2-2□	8	14	5.5	8	14	2
	15	FRN0069E2-2□	14	22	5.5	14	14	2
	18.5	FRN0088E2-2□	14	38 ⁷	8	22	22	2
22	FRN0115E2-2□	22	38 ⁷	8	22	38 ⁷	2	
Three-phase 400 V	0.4	FRN0002E2-4□	2	2	2	2	2	2
	0.75	FRN0004E2-4□	2	2	2	2	2	2
	1.5	FRN0006E2-4□	2	2	2	2	2	2
	2.2	FRN0007E2-4□	2	2	2	2	2	2
	3.7	FRN0012E2-4□	2	2	2	2	2	2
	5.5	FRN0022E2-4□	2	2	2	2	2	2
	7.5	FRN0029E2-4□	2	3.5	2	2	2	2
	11	FRN0037E2-4□	2	5.5	3.5	3.5	3.5	2
	15	FRN0044E2-4□	3.5	8	5.5	3.5	5.5	2
	18.5	FRN0059E2-4□	5.5	14	5.5	5.5	8 ¹¹	2
	22	FRN0072E2-4□	8 ¹¹	14	5.5	8 ¹¹	14	2
	30	FRN0085E2-4□	14	22	8	14	14	-
	37	FRN0105E2-4□	14	38	8	22	22	-
	45	FRN0139E2-4□	22	38	8	22	38	-
	55	FRN0168E2-4□	38	60	14	38	38	-
	75	FRN0203E2-4□	60	-	14	60	60	-
	90	FRN0240E2-4□	60	-	14	60	100	-
	110	FRN0290E2-4□	100	-	22	100	-	-
132	FRN0361E2-4□	100	-	22	-	-	-	
160	FRN0415E2-4□	-	-	22	-	-	-	
200	FRN0520E2-4□	-	-	38	-	-	-	
220	FRN0590E2-4□	-	-	38	-	-	-	
Single-phase 200 V	0.1	FRN0001E2-7□	2	2	2	2	2	2
	0.2	FRN0002E2-7□	2	2	2	2	2	2
	0.4	FRN0003E2-7□	2	2	2	2	2	2
	0.75	FRN0005E2-7□	2	2	2	2	2	2
	1.5	FRN0008E2-7□	2	2	2	2	2	2
	2.2	FRN0011E2-7□	2	3.5	2	2	2	2

The recommended wire sizes for the main circuit terminals assume using 60°C IV wire.

*1 For compatible crimped terminals, please use model 8-L6 by JST Mfg. Co., Ltd. or equivalent.

2) Ambient temperature: Below 40°C, Wire type: 75°C wire

Table 2.2-13 Recommended Wire Sizes, Ambient temperature: Below 40°C, Wire type: 75°C wire (continued)

ND Mode, Ambient temperature: Below 40°C, Wire type: 75°C wire

Power System	Std Applicable Motor (kW)	Inverter type	Recommended wire size (mm ²)					
			Main power supply input [L1/R, L2/S, L3/T]		Ground terminal [⊕G]	Inverter output [U, V, W]	For DC reactor connection [P1, P(+)]	For braking resistor connection [P(+), DB]
			With DC reactor	Without DC reactor				
Three-phase 400 V	0.75	FRN0002E2■-4□	2	2	2	2	2	2
	1.5	FRN0004E2■-4□	2	2	2	2	2	2
	2.2	FRN0006E2■-4□	2	2	2	2	2	2
	3.0	FRN0007E2■-4□	2	2	2	2	2	2
	5.5	FRN0012E2■-4□	2	2	2	2	2	2
	11	FRN0022E2■-4□	2	3.5	3.5	2	2	2
	15	FRN0029E2■-4□	2	5.5	5.5	2	3.5	2
	18.5	FRN0037E2■-4□	3.5	8	5.5	3.5	5.5	2
	22	FRN0044E2■-4□	5.5	8	5.5	5.5	5.5	2
	30	FRN0059E2■-4□	8 ^{*1}	14	8 ^{*1}	8 ^{*1}	14	2
	37	FRN0072E2■-4□	14	14	8 ^{*1}	14	14	2
	45	FRN0085E2■-4□	14	22	8	14	22	-
	55	FRN0105E2■-4□	22	38	14	22	38	-
	75	FRN0139E2■-4□	38	-	14	38	38	-
	90	FRN0168E2■-4□	38	-	14	38	60	-
	110	FRN0203E2■-4□	60	-	22	60	100	-
	132	FRN0240E2■-4□	100	-	22	100	100	-
	160	FRN0290E2■-4□	100	-	22	100	150 ^{*3}	-
	200	FRN0361E2■-4□	150	-	38	150	200	-
220	FRN0415E2■-4□	150	-	38	150	200	-	
280	FRN0520E2■-4□	200	-	38	250	325	-	
315	FRN0590E2■-4□	250	-	60	250	325	-	

HD Mode, Ambient temperature: Below 40°C, Wire type: 75°C wire

Power System	Std Applicable Motor (kW)	Inverter type	Recommended wire size (mm ²)					
			Main power supply input [L1/R, L2/S, L3/T]		Ground terminal [⊕G]	Inverter output [U, V, W]	For DC reactor connection [P1, P(+)]	For braking resistor connection [P(+), DB]
			With DC reactor	Without DC reactor				
Three-phase 400 V	0.75	FRN0002E2■-4□	2	2	2	2	2	2
	1.1	FRN0004E2■-4□	2	2	2	2	2	2
	2.2	FRN0006E2■-4□	2	2	2	2	2	2
	3.0	FRN0007E2■-4□	2	2	2	2	2	2
	5.5	FRN0012E2■-4□	2	2	2	2	2	2
	7.5	FRN0022E2■-4□	2	2	2	2	2	2
	11	FRN0029E2■-4□	2	3.5	3.5	2	2	2
	15	FRN0037E2■-4□	2	5.5	5.5	3.5	3.5	2
	18.5	FRN0044E2■-4□	3.5	8	5.5	3.5	5.5	2
	22	FRN0059E2■-4□	5.5	8 ^{*1}	5.5	5.5	5.5	2
	30	FRN0072E2■-4□	8 ^{*1}	14	8 ^{*1}	8 ^{*1}	14	2
	37	FRN0085E2■-4□	14	14	8	14	14	-
	45	FRN0105E2■-4□	14	22	8	14	22	-
	55	FRN0139E2■-4□	22	38	14	22	38	-
	75	FRN0168E2■-4□	38	-	14	38	38	-
	90	FRN0203E2■-4□	38	-	14	60	60	-
	110	FRN0240E2■-4□	60	-	22	60	100	-
	132	FRN0290E2■-4□	100	-	22	100	100	-
	160	FRN0361E2■-4□	100	-	22	100	150	-
200	FRN0415E2■-4□	150	-	38	150	200	-	
220	FRN0520E2■-4□	150	-	38	150	200	-	
250	FRN0590E2■-4□	200	-	38	200	250	-	

The recommended wire sizes for the main circuit terminals assume using 75°C 600 V HIV wire.

*1 For compatible crimped terminals, please use model 8-L6 by JST Mfg. Co., Ltd. or equivalent.

*3 For compatible crimped terminals, please use model CB150-10 by JST Mfg. Co., Ltd. or equivalent.

Table 2.2-14 Recommended Wire Sizes, Ambient temperature: Below 40°C, Wire type: 75°C wire (continued)

HND Mode, Ambient temperature: Below 40°C, Wire type: 75°C wire

Power System	Std Applicable Motor (kW)	Inverter type	Recommended wire size (mm ²)					
			Main power supply input [L1/R, L2/S, L3/T]		Ground terminal [⊕G]	Inverter output [U, V, W]	For DC reactor connection [P1, P(+)]	For braking resistor connection [P(+), DB]
			With DC reactor	Without DC reactor				
Three-phase 200 V	0.2	FRN0001E2■-2□	2	2	2	2	2	2
	0.4	FRN0002E2■-2□	2	2	2	2	2	2
	0.75	FRN0004E2■-2□	2	2	2	2	2	2
	1.5	FRN0006E2■-2□	2	2	2	2	2	2
	2.2	FRN0010E2■-2□	2	2	2	2	2	2
	3.0	FRN0012E2■-2□ ^{*10}	2	2	2	2	2	2
	5.5	FRN0020E2■-2□ ^{*10}	2	3.5	3.5	2	2	2
	7.5	FRN0030E2■-2□	2	5.5	5.5	3.5	3.5	2
	11	FRN0040E2■-2□	5.5	8	5.5	5.5	5.5	2
	15	FRN0056E2■-2□	8	14	5.5	8	14	2
	18.5	FRN0069E2■-2□	14	22	8	14	14	2
	22	FRN0088E2■-2□	14	22	8	14	22	2
30	FRN0115E2■-2□	22	38 ^{*7}	14	22	38 ^{*7}	2	
Three-phase 400 V	0.75	FRN0002E2■-4□	2	2	2	2	2	2
	1.1	FRN0004E2■-4□	2	2	2	2	2	2
	2.2	FRN0006E2■-4□	2	2	2	2	2	2
	3.0	FRN0007E2■-4□ ^{*10}	2	2	2	2	2	2
	5.5	FRN0012E2■-4□ ^{*10}	2	2	2	2	2	2
	7.5	FRN0022E2■-4□	2	2	2	2	2	2
	11	FRN0029E2■-4□	2	3.5	3.5	2	2	2
	15	FRN0037E2■-4□	2	5.5	3.5	3.5	3.5	2
	18.5	FRN0044E2■-4□	5.5	8	5.5	5.5	5.5	2
	22	FRN0059E2■-4□	5.5	8 ^{*1}	5.5	5.5	5.5	2
	30	FRN0072E2■-4□	8 ^{*1}	14	8 ^{*1}	8 ^{*1}	14	2
	37	FRN0085E2■-4□	14	14	8	14	14	-
	45	FRN0105E2■-4□	14	22	8	14	22	-
	55	FRN0139E2■-4□	22	38	14	22	38	-
	75	FRN0168E2■-4□	38	-	14	38	38	-
	90	FRN0203E2■-4□	38	-	14	60	60	-
	110	FRN0240E2■-4□	60	-	22	60	100	-
	132	FRN0290E2■-4□	100	-	22	100	100	-
160	FRN0361E2■-4□	100	-	22	100	150	-	
200	FRN0415E2■-4□	150	-	38	150	200	-	
220	FRN0520E2■-4□	150	-	38	150	200	-	
280	FRN0590E2■-4□	200	-	38	250	325	-	

The recommended wire sizes for the main circuit terminals assume using 75°C 600V HIV wire.

*1 For compatible crimped terminals, please use model 8-L6 by JST Mfg. Co., Ltd. or equivalent.

*4 For compatible crimped terminals, please use model R5.5-6 by JST Mfg. Co., Ltd. or equivalent.

*7 For compatible crimped terminals, please use model 38-6 by JST Mfg. Co., Ltd. or equivalent.

*10 ND-spec.

Table 2.2-15 Recommended Wire Sizes, Ambient temperature: Below 40°C, Wire type: 75°C wire (continued)

HHD Mode, Ambient temperature: Below 40°C, Wire type: 75°C wire

Power System	Std Applicable Motor (kW)	Inverter type	Recommended wire size (mm ²)					
			Main power supply input [L1/R, L2/S, L3/T]		Ground terminal [⊕G]	Inverter output [U, V, W]	For DC reactor connection [P1, P(+)]	For braking resistor connection [P(+), DB]
			With DC reactor	Without DC reactor				
Three-phase 200 V	0.1	FRN0001E2-2□	2	2	2	2	2	2
	0.2	FRN0002E2-2□	2	2	2	2	2	2
	0.4	FRN0004E2-2□	2	2	2	2	2	2
	0.75	FRN0006E2-2□	2	2	2	2	2	2
	1.5	FRN0010E2-2□	2	2	2	2	2	2
	2.2	FRN0012E2-2□	2	2	2	2	2	2
	3.7	FRN0020E2-2□	2	2	2	2	2	2
	5.5	FRN0030E2-2□	2	3.5	3.5	2	2	2
	7.5	FRN0040E2-2□	2	5.5	5.5	3.5	3.5	2
	11	FRN0056E2-2□	5.5	8	5.5	5.5	5.5	2
	15	FRN0069E2-2□	8	14	5.5	8	14	2
	18.5	FRN0088E2-2□	14	22	8	14	14	2
22	FRN0115E2-2□	14	22	8	14	22	2	
Three-phase 400 V	0.4	FRN0002E2-4□	2	2	2	2	2	2
	0.75	FRN0004E2-4□	2	2	2	2	2	2
	1.5	FRN0006E2-4□	2	2	2	2	2	2
	2.2	FRN0007E2-4□	2	2	2	2	2	2
	3.7	FRN0012E2-4□	2	2	2	2	2	2
	5.5	FRN0022E2-4□	2	2	2	2	2	2
	7.5	FRN0029E2-4□	2	2	2	2	2	2
	11	FRN0037E2-4□	2	3.5	3.5	2	2	2
	15	FRN0044E2-4□	2	5.5	5.5	3.5	3.5	2
	18.5	FRN0059E2-4□	3.5 ^{*4}	8 ^{*1}	5.5	3.5 ^{*4}	5.5	2
	22	FRN0072E2-4□	5.5	8 ^{*1}	5.5	5.5	5.5	2
	30	FRN0085E2-4□	8	14	8	8	14	-
	37	FRN0105E2-4□	14	14	8	14	14	-
	45	FRN0139E2-4□	14	22	8	14	22	-
	55	FRN0168E2-4□	22	38	14	22	38	-
	75	FRN0203E2-4□	38	-	14	38	38	-
	90	FRN0240E2-4□	38	-	14	60	60	-
110	FRN0290E2-4□	60	-	22	60	100	-	
132	FRN0361E2-4□	100	-	22	100	100	-	
160	FRN0415E2-4□	100	-	22	100	150	-	
200	FRN0520E2-4□	150	-	38	150	200	-	
220	FRN0590E2-4□	150	-	38	150	200	-	
Single-phase 200 V	0.1	FRN0001E2-7□	2	2	2	2	2	2
	0.2	FRN0002E2-7□	2	2	2	2	2	2
	0.4	FRN0003E2-7□	2	2	2	2	2	2
	0.75	FRN0005E2-7□	2	2	2	2	2	2
	1.5	FRN0008E2-7□	2	2	2	2	2	2
	2.2	FRN0011E2-7□	2	2	2	2	2	2

The recommended wire sizes for the main circuit terminals assume using 75°C 600V HIV wire.

*1 For compatible crimped terminals, please use model 8-L6 by JST Mfg. Co., Ltd. or equivalent.

*4 For compatible crimped terminals, please use model R5.5-6 by JST Mfg. Co., Ltd. or equivalent.

3) Ambient temperature: Below 40°C, Wire type: 90°C wire

Table 2.2-16 Recommended Wire Sizes, Ambient temperature: Below 40°C, Wire type: 90°C wire

ND Mode, Ambient temperature: Below 40°C, Wire type: 90°C wire

Power System	Std Applicable Motor (kW)	Inverter type	Recommended wire size (mm ²)					
			Main power supply input [L1/R, L2/S, L3/T]		Ground terminal [⊕G]	Inverter output [U, V, W]	For DC reactor connection [P1, P(+)]	For braking resistor connection [P(+), DB]
			With DC reactor	Without DC reactor				
Three-phase 400 V	0.75	FRN0002E2■-4□	2	2	2	2	2	2
	1.5	FRN0004E2■-4□	2	2	2	2	2	2
	2.2	FRN0006E2■-4□	2	2	2	2	2	2
	3.0	FRN0007E2■-4□	2	2	2	2	2	2
	5.5	FRN0012E2■-4□	2	2	2	2	2	2
	11	FRN0022E2■-4□	2	2	3.5	2	2	2
	15	FRN0029E2■-4□	2	3.5	5.5	2	3.5	2
	18.5	FRN0037E2■-4□	3.5	5.5	5.5	3.5	3.5	2
	22	FRN0044E2■-4□	3.5	5.5	5.5	3.5	5.5	2
	30	FRN0059E2■-4□	5.5	8 ^{*1}	8 ^{*1}	5.5	8 ^{*1}	2
	37	FRN0072E2■-4□	8 ^{*1}	14	8 ^{*1}	8 ^{*1}	14	2
	45	FRN0085E2■-4□	14	22	8	14	14	-
	55	FRN0105E2■-4□	14	22	14	14	22	-
	75	FRN0139E2■-4□	22	-	14	22	38	-
	90	FRN0168E2■-4□	38	-	14	38	38	-
	110	FRN0203E2■-4□	38	-	22	38	60	-
	132	FRN0240E2■-4□	60	-	22	60	100	-
	160	FRN0290E2■-4□	100	-	22	100	100	-
	200	FRN0361E2■-4□	100	-	38	100	150	-
220	FRN0415E2■-4□	150	-	38	150	150	-	
280	FRN0520E2■-4□	150	-	38	200	250	-	
315	FRN0590E2■-4□	200	-	60	200	250	-	

HD Mode, Ambient temperature: Below 40°C, Wire type: 90°C wire

Power System	Std Applicable Motor (kW)	Inverter type	Recommended wire size (mm ²)					
			Main power supply input [L1/R, L2/S, L3/T]		Ground terminal [⊕G]	Inverter output [U, V, W]	For DC reactor connection [P1, P(+)]	For braking resistor connection [P(+), DB]
			With DC reactor	Without DC reactor				
Three-phase 400 V	0.75	FRN0002E2■-4□	2	2	2	2	2	2
	1.1	FRN0004E2■-4□	2	2	2	2	2	2
	2.2	FRN0006E2■-4□	2	2	2	2	2	2
	3.0	FRN0007E2■-4□	2	2	2	2	2	2
	5.5	FRN0012E2■-4□	2	2	2	2	2	2
	7.5	FRN0022E2■-4□	2	2	2	2	2	2
	11	FRN0029E2■-4□	2	2	3.5	2	2	2
	15	FRN0037E2■-4□	2	3.5	5.5	2	3.5	2
	18.5	FRN0044E2■-4□	3.5	5.5	5.5	3.5	3.5	2
	22	FRN0059E2■-4□	3.5 ^{*4}	5.5	5.5	3.5 ^{*4}	5.5	2
	30	FRN0072E2■-4□	5.5	8 ^{*1}	8 ^{*1}	5.5	8 ^{*1}	2
	37	FRN0085E2■-4□	8	14	8	8	14	-
	45	FRN0105E2■-4□	14	22	8	14	14	-
	55	FRN0139E2■-4□	14	22	14	14	22	-
	75	FRN0168E2■-4□	22	-	14	38	38	-
	90	FRN0203E2■-4□	38	-	14	38	38	-
	110	FRN0240E2■-4□	38	-	22	60	60	-
	132	FRN0290E2■-4□	60	-	22	60	100	-
	160	FRN0361E2■-4□	100	-	22	100	100	-
200	FRN0415E2■-4□	100	-	38	100	150	-	
220	FRN0520E2■-4□	150	-	38	150	150	-	
250	FRN0590E2■-4□	150	-	38	150	200	-	

The recommended wire sizes for the main circuit terminals assume using 90°C 600 V FSLC wire.

*1 For compatible crimped terminals, please use model 8-L6 by JST Mfg. Co., Ltd. or equivalent.

*4 For compatible crimped terminals, please use model R5.5-6 by JST Mfg. Co., Ltd. or equivalent.

Table 2.2-17 Recommended Wire Sizes, Ambient temperature: Below 40°C, Wire type: 90°C wire (continued)

HND Mode, Ambient temperature: Below 40°C, Wire type: 90°C wire

Power System	Std Applicable Motor (kW)	Inverter type	Recommended wire size (mm ²)					
			Main power supply input [L1/R, L2/S, L3/T]		Ground terminal [G]	Inverter output [U, V, W]	For DC reactor connection [P1, P(+)]	For braking resistor connection [P(+), DB]
			With DC reactor	Without DC reactor				
Three-phase 200 V	0.2	FRN0001E2-2□	2	2	2	2	2	2
	0.4	FRN0002E2-2□	2	2	2	2	2	2
	0.75	FRN0004E2-2□	2	2	2	2	2	2
	1.1	FRN0006E2-2□	2	2	2	2	2	2
	2.2	FRN0010E2-2□	2	2	2	2	2	2
	3.0	FRN0012E2-2□ ^{*10}	2	2	2	2	2	2
	5.5	FRN0020E2-2□ ^{*10}	2	2	3.5	2	2	2
	7.5	FRN0030E2-2□	2	3.5	5.5	2	3.5	2
	11	FRN0040E2-2□	3.5	5.5	5.5	3.5	5.5	2
	15	FRN0056E2-2□	5.5	14	5.5	5.5	8	2
	18.5	FRN0069E2-2□	8	14	8	8	14	2
	22	FRN0088E2-2□	14	14	8	14	14	2
30	FRN0115E2-2□	22	38 ^{*7}	14	22	22	2	
Three-phase 400 V	0.75	FRN0002E2-4□	2	2	2	2	2	2
	1.1	FRN0004E2-4□	2	2	2	2	2	2
	2.2	FRN0006E2-4□	2	2	2	2	2	2
	3.0	FRN0007E2-4□ ^{*10}	2	2	2	2	2	2
	5.5	FRN0012E2-4□ ^{*10}	2	2	2	2	2	2
	7.5	FRN0022E2-4□	2	2	2	2	2	2
	11	FRN0029E2-4□	2	2	3.5	2	2	2
	15	FRN0037E2-4□	2	3.5	3.5	3.5	3.5	2
	18.5	FRN0044E2-4□	3.5	5.5	5.5	3.5	3.5	2
	22	FRN0059E2-4□	3.5 ^{*4}	5.5	5.5	3.5 ^{*4}	5.5	2
	30	FRN0072E2-4□	5.5	8 ^{*1}	8 ^{*1}	5.5	8 ^{*1}	2
	37	FRN0085E2-4□	8	14	8	8	14	-
	45	FRN0105E2-4□	14	22	8	14	14	-
	55	FRN0139E2-4□	14	22	14	14	22	-
	75	FRN0168E2-4□	22	-	14	38	38	-
	90	FRN0203E2-4□	38	-	14	38	38	-
	110	FRN0240E2-4□	38	-	22	60	60	-
	132	FRN0290E2-4□	60	-	22	60	100	-
160	FRN0361E2-4□	100	-	22	100	100	-	
200	FRN0415E2-4□	100	-	38	100	150	-	
220	FRN0520E2-4□	150	-	38	150	150	-	
280	FRN0590E2-4□	150	-	38	200	250	-	

The recommended wire sizes for the main circuit terminals assume using 90°C 600 V FSLC wire.

*1 For compatible crimped terminals, please use model 8-L6 by JST Mfg. Co., Ltd. or equivalent.

*4 For compatible crimped terminals, please use model R5.5-6 by JST Mfg. Co., Ltd. or equivalent.

*7 For compatible crimped terminals, please use model 38-6 by JST Mfg. Co., Ltd. or equivalent.

*10 ND-spec.

Table 2.2-18 Recommended Wire Sizes, Ambient temperature: Below 40°C, Wire type: 90°C wire (continued)

HHD Mode, Ambient temperature: Below 40°C, Wire type: 90°C wire

Power System	Std Applicable Motor (kW)	Inverter type	Recommended wire size (mm ²)					
			Main power supply input [L1/R, L2/S, L3/T]		Ground terminal [G]	Inverter output [U, V, W]	For DC reactor connection [P1, P(+)]	For braking resistor connection [P(+), DB]
			With DC reactor	Without DC reactor				
Three-phase 200 V	0.1	FRN0001E2■-2□	2	2	2	2	2	2
	0.2	FRN0002E2■-2□	2	2	2	2	2	2
	0.4	FRN0004E2■-2□	2	2	2	2	2	2
	0.75	FRN0006E2■-2□	2	2	2	2	2	2
	1.5	FRN0010E2■-2□	2	2	2	2	2	2
	2.2	FRN0012E2■-2□	2	2	2	2	2	2
	3.7	FRN0020E2■-2□	2	2	2	2	2	2
	5.5	FRN0030E2■-2□	2	2	3.5	2	2	2
	7.5	FRN0040E2■-2□	2	3.5	5.5	2	3.5	2
	11	FRN0056E2■-2□	3.5	5.5	5.5	3.5	5.5	2
	15	FRN0069E2■-2□	5.5	14	5.5	5.5	8	2
	18.5	FRN0088E2■-2□	8	14	8	8	14	2
22	FRN0115E2■-2□	14	14	8	14	14	2	
Three-phase 400 V	0.4	FRN0002E2■-4□	2	2	2	2	2	2
	0.75	FRN0004E2■-4□	2	2	2	2	2	2
	1.5	FRN0006E2■-4□	2	2	2	2	2	2
	2.2	FRN0007E2■-4□	2	2	2	2	2	2
	3.7	FRN0012E2■-4□	2	2	2	2	2	2
	5.5	FRN0022E2■-4□	2	2	2	2	2	2
	7.5	FRN0029E2■-4□	2	2	2	2	2	2
	11	FRN0037E2■-4□	2	2	3.5	2	2	2
	15	FRN0044E2■-4□	2	3.5	5.5	2	3.5	2
	18.5	FRN0059E2■-4□	3.5 ^{*4}	5.5	5.5	3.5 ^{*4}	3.5 ^{*4}	2
	22	FRN0072E2■-4□	3.5 ^{*4}	5.5	5.5	3.5 ^{*4}	5.5	2
	30	FRN0085E2■-4□	5.5	8	8	5.5	8	-
	37	FRN0105E2■-4□	8	14	8	8	14	-
	45	FRN0139E2■-4□	14	22	8	14	14	-
	55	FRN0168E2■-4□	14	22	14	14	22	-
	75	FRN0203E2■-4□	22	-	14	38	38	-
	90	FRN0240E2■-4□	38	-	14	38	38	-
110	FRN0290E2■-4□	38	-	22	60	60	-	
132	FRN0361E2■-4□	60	-	22	60	100	-	
160	FRN0415E2■-4□	100	-	22	100	100	-	
200	FRN0520E2■-4□	100	-	38	100	150	-	
220	FRN0590E2■-4□	150	-	38	150	150	-	
Single-phase 200 V	0.1	FRN0001E2■-7□	2	2	2	2	2	2
	0.2	FRN0002E2■-7□	2	2	2	2	2	2
	0.4	FRN0003E2■-7□	2	2	2	2	2	2
	0.75	FRN0005E2■-7□	2	2	2	2	2	2
	1.5	FRN0008E2■-7□	2	2	2	2	2	2
	2.2	FRN0011E2■-7□	2	2	2	2	2	2

The recommended wire sizes for the main circuit terminals assume using 90°C 600 V FSLC wire.

*1 For compatible crimped terminals, please use model 8-L6 by JST Mfg. Co., Ltd. or equivalent.

*4 For compatible crimped terminals, please use model R5.5-6 by JST Mfg. Co., Ltd. or equivalent.

4) Ambient temperature: Below 50°C, Wire type: 60°C wire

Table 2.2-19 Recommended Wire Sizes, Ambient temperature: Below 50°C, Wire type: 60°C wire

ND Mode, Ambient temperature: Below 50°C, Wire type: 60°C wire

Power System	Std Applicable Motor (kW)	Inverter type	Recommended wire size (mm ²)					
			Main power supply input (Note 1) [L1/R, L2/S, L3/T]		Ground terminal (Note 1) [⊕G]	Inverter output (Note 1) [U, V, W]	For DC reactor connection (Note 1) [P1, P(+)]	For braking resistor connection [P(+), DB]
			With DC reactor	Without DC reactor				
Three-phase 400 V	0.75	FRN0002E2■-4□	2	2	2	2	2	2
	1.5	FRN0004E2■-4□	2	2	2	2	2	2
	2.2	FRN0006E2■-4□	2	2	2	2	2	2
	3.0	FRN0007E2■-4□	2	2	2	2	2	2
	5.5	FRN0012E2■-4□	2	3.5	2	2	2	2
	11	FRN0022E2■-4□	3.5	5.5	3.5	3.5	3.5	2
	15	FRN0029E2■-4□	5.5	14	5.5	5.5	5.5	2
	18.5	FRN0037E2■-4□	8	14	5.5	8	5.5	2
	22	FRN0044E2■-4□	8	14	5.5	14	8	2
	30	FRN0059E2■-4□	14	22	8 ^{*1}	14	22	2
	37	FRN0072E2■-4□	22	38	8 ^{*1}	22	38	2
	45	FRN0085E2■-4□	38	38	8	38	38	-
	55	FRN0105E2■-4□	38	60	14	38	60	-
	75	FRN0139E2■-4□	60	-	14	60	100 ^{*2}	-
	90	FRN0168E2■-4□	100 ^{*2}	-	14	100 ^{*2}	100 ^{*2}	-
	110	FRN0203E2■-4□	100	-	22	100	-	-
	132	FRN0240E2■-4□	-	-	22	-	-	-
	160	FRN0290E2■-4□	-	-	22	-	-	-
	200	FRN0361E2■-4□	-	-	38	-	-	-
220	FRN0415E2■-4□	-	-	38	-	-	-	
280	FRN0520E2■-4□	-	-	38	-	-	-	
315	FRN0590E2■-4□	-	-	60	-	-	-	

HD Mode, Ambient temperature: Below 50°C, Wire type: 60°C wire

Power System	Std Applicable Motor (kW)	Inverter type	Recommended wire size (mm ²)					
			Main power supply input (Note 1) [L1/R, L2/S, L3/T]		Ground terminal (Note 1) [⊕G]	Inverter output (Note 1) [U, V, W]	For DC reactor connection (Note 1) * [P1, P(+)]	For braking resistor connection [P(+), DB]
			With DC reactor	Without DC reactor				
Three-phase 400 V	0.75	FRN0002E2■-4□	2	2	2	2	2	2
	1.1	FRN0004E2■-4□	2	2	2	2	2	2
	2.2	FRN0006E2■-4□	2	2	2	2	2	2
	3.0	FRN0007E2■-4□	2	2	2	2	2	2
	5.5	FRN0012E2■-4□	2	3.5	2	2	2	2
	7.5	FRN0022E2■-4□	2	3.5	2	2	2	2
	11	FRN0029E2■-4□	3.5	5.5	3.5	3.5	3.5	2
	15	FRN0037E2■-4□	5.5	14	5.5	5.5	5.5	2
	18.5	FRN0044E2■-4□	8	14	5.5	8	5.5	2
	22	FRN0059E2■-4□	8 ^{*1}	14	5.5	14	14	2
	30	FRN0072E2■-4□	14	22	8 ^{*1}	14	22	2
	37	FRN0085E2■-4□	22	38	8	22	38	-
	45	FRN0105E2■-4□	38	38	8	38	38	-
	55	FRN0139E2■-4□	38	60	14	38	60	-
	75	FRN0168E2■-4□	60	-	14	60	100 ^{*2}	-
	90	FRN0203E2■-4□	100	-	14	100	100	-
	110	FRN0240E2■-4□	100	-	22	100	-	-
	132	FRN0290E2■-4□	-	-	22	-	-	-
	160	FRN0361E2■-4□	-	-	22	-	-	-
200	FRN0415E2■-4□	-	-	38	-	-	-	
220	FRN0520E2■-4□	-	-	38	-	-	-	
250	FRN0590E2■-4□	-	-	38	-	-	-	

Note 1) The rated current must be reduced for operation (Rated current x 80%). Recommended wire sizes assume these conditions.

The recommended wire sizes for the main circuit terminals assume using 60°C IV wire.

*1 For compatible crimped terminals, please use model 8-L6 by JST Mfg. Co., Ltd. or equivalent.

*2 For compatible crimped terminals, please use model CB100-S8 by JST Mfg. Co., Ltd. or equivalent.

Table 2.2-20 Recommended Wire Sizes, Ambient temperature: Below 50°C, Wire type: 60°C wire (continued)

HND Mode, Ambient temperature: Below 50°C, Wire type: 60°C wire

Power System	Std Applicable Motor (kW)	Inverter type	Recommended wire size (mm ²)					
			Main power supply input [L1/R, L2/S, L3/T]		Ground terminal [G]	Inverter output [U, V, W]	For DC reactor connection [P1, P(+)]	For braking resistor connection [P(+), DB]
			With DC reactor	Without DC reactor				
Three-phase 200 V	0.2	FRN0001E2■-2□	2	2	2	2	2	2
	0.4	FRN0002E2■-2□	2	2	2	2	2	2
	0.75	FRN0004E2■-2□	2	2	2	2	2	2
	1.1	FRN0006E2■-2□	2	2	2	2	2	2
	2.2	FRN0010E2■-2□	2	2	2	2	2	2
	3.0	FRN0012E2■-2□ ^{*10}	2	3.5	2	2	2	2
	5.5	FRN0020E2■-2□ ^{*10}	3.5	8	3.5	3.5	5.5	2
	7.5	FRN0030E2■-2□	8	14	5.5	8	14	2
	11	FRN0040E2■-2□	14	22 ^{*3}	5.5	14	22 ^{*3}	2
	15	FRN0056E2■-2□	22	38 ^{*4}	5.5	22	38 ^{*4}	2
	18.5	FRN0069E2■-2□	38 ^{*4}	60 ^{*5}	8	38 ^{*4}	38 ^{*4}	2
	22	FRN0088E2■-2□	38 ^{*7}	60 ^{*8}	8	38 ^{*7}	60 ^{*8}	2
30	FRN0115E2■-2□	60 ^{*8}	100 ^{*9}	14	60 ^{*8}	100 ^{*9}	2	
Three-phase 400 V	0.75	FRN0002E2■-4□	2	2	2	2	2	2
	1.1	FRN0004E2■-4□	2	2	2	2	2	2
	2.2	FRN0006E2■-4□	2	2	2	2	2	2
	3.0	FRN0007E2■-4□ ^{*10}	2	2	2	2	2	2
	5.5	FRN0012E2■-4□ ^{*10}	2	3.5	2	2	2	2
	7.5	FRN0022E2■-4□	2	5.5	2	3.5	3.5	2
	11	FRN0029E2■-4□	5.5	8	3.5	5.5	5.5	2
	15	FRN0037E2■-4□	8	14	3.5	8	14	2
	18.5	FRN0044E2■-4□	14	22	5.5	14	14	2
	22	FRN0059E2■-4□	14	22	5.5	14	22	2
	30	FRN0072E2■-4□	22	38	8 ^{*1}	22	38	2
	37	FRN0085E2■-4□	38	60	8	38	38	-
	45	FRN0105E2■-4□	38	60	8	38	60	-
	55	FRN0139E2■-4□	60	100 ^{*2}	14	60	60	-
	75	FRN0168E2■-4□	100 ^{*2}	-	14	100 ^{*2}	100 ^{*2}	-
	90	FRN0203E2■-4□	100	-	14	-	-	-
	110	FRN0240E2■-4□	-	-	22	-	-	-
132	FRN0290E2■-4□	-	-	22	-	-	-	
160	FRN0361E2■-4□	-	-	22	-	-	-	
200	FRN0415E2■-4□	-	-	38	-	-	-	
220	FRN0520E2■-4□	-	-	38	-	-	-	
280	FRN0590E2■-4□	-	-	38	-	-	-	

The recommended wire sizes for the main circuit terminals assume using 60°C IV wire.

- *1 For compatible crimped terminals, please use model 8-L6 by JST Mfg. Co., Ltd. or equivalent.
- *2 For compatible crimped terminals, please use model CB100-S8 by JST Mfg. Co., Ltd. or equivalent.
- *3 For compatible crimped terminals, please use model 22-S5 by JST Mfg. Co., Ltd. or equivalent.
- *4 For compatible crimped terminals, please use model 38-S6 by JST Mfg. Co., Ltd. or equivalent.
- *5 For compatible crimped terminals, please use model CB60-S6 by JST Mfg. Co., Ltd. or equivalent.
- *7 For compatible crimped terminals, please use model 38-6 by JST Mfg. Co., Ltd. or equivalent.
- *8 For compatible crimped terminals, please use model 60-6 by JST Mfg. Co., Ltd. or equivalent.
- *9 For compatible crimped terminals, please use model CB100-S8 by JST Mfg. Co., Ltd. or equivalent.
- *10 ND-spec.

Table 2.2-21 Recommended Wire Sizes, Ambient temperature: Below 50°C, Wire type: 60°C wire (continued)

HHD Mode, Ambient temperature: Below 50°C, Wire type: 60°C wire

Power System	Std Applicable Motor (kW)	Inverter type	Recommended wire size (mm ²)					
			Main power supply input [L1/R, L2/S, L3/T]		Ground terminal [⊕G]	Inverter output [U, V, W]	For DC reactor connection [P1, P(+)]	For braking resistor connection [P(+), DB]
			With DC reactor	Without DC reactor				
Three-phase 200 V	0.1	FRN0001E2■-2□	2	2	2	2	2	2
	0.2	FRN0002E2■-2□	2	2	2	2	2	2
	0.4	FRN0004E2■-2□	2	2	2	2	2	2
	0.75	FRN0006E2■-2□	2	2	2	2	2	2
	1.5	FRN0010E2■-2□	2	2	2	2	2	2
	2.2	FRN0012E2■-2□	2	2	2	2	2	2
	3.7	FRN0020E2■-2□	2	5.5	2	3.5	3.5	2
	5.5	FRN0030E2■-2□	5.5	8	3.5	5.5	5.5	2
	7.5	FRN0040E2■-2□	8	14	5.5	8	14	2
	11	FRN0056E2■-2□	14	22	5.5	14	22	2
	15	FRN0069E2■-2□	22	38	5.5	22	38	2
	18.5	FRN0088E2■-2□	38 ^{*7}	60 ^{*8}	8	38 ^{*7}	38 ^{*7}	2
22	FRN0115E2■-2□	38 ^{*7}	60 ^{*8}	8	38 ^{*7}	60 ^{*8}	2	
Three-phase 400 V	0.4	FRN0002E2■-4□	2	2	2	2	2	2
	0.75	FRN0004E2■-4□	2	2	2	2	2	2
	1.5	FRN0006E2■-4□	2	2	2	2	2	2
	2.2	FRN0007E2■-4□	2	2	2	2	2	2
	3.7	FRN0012E2■-4□	2	2	2	2	2	2
	5.5	FRN0022E2■-4□	2	3.5	2	2	2	2
	7.5	FRN0029E2■-4□	2	5.5	2	3.5	3.5	2
	11	FRN0037E2■-4□	5.5	8	3.5	5.5	5.5	2
	15	FRN0044E2■-4□	8	14	5.5	8	14	2
	18.5	FRN0059E2■-4□	14	22	5.5	14	14	2
	22	FRN0072E2■-4□	14	22	5.5	14	22	2
	30	FRN0085E2■-4□	22	38	8	22	38	-
	37	FRN0105E2■-4□	38	60	8	38	38	-
	45	FRN0139E2■-4□	38	60	8	38	60	-
	55	FRN0168E2■-4□	60	100 ^{*2}	14	60	60	-
	75	FRN0203E2■-4□	100	-	14	100	100	-
	90	FRN0240E2■-4□	100	-	14	-	-	-
110	FRN0290E2■-4□	-	-	22	-	-	-	
132	FRN0361E2■-4□	-	-	22	-	-	-	
160	FRN0415E2■-4□	-	-	22	-	-	-	
200	FRN0520E2■-4□	-	-	38	-	-	-	
220	FRN0590E2■-4□	-	-	38	-	-	-	
Single-phase 200 V	0.1	FRN0001E2■-7□	2	2	2	2	2	2
	0.2	FRN0002E2■-7□	2	2	2	2	2	2
	0.4	FRN0003E2■-7□	2	2	2	2	2	2
	0.75	FRN0005E2■-7□	2	2	2	2	2	2
	1.5	FRN0008E2■-7□	2	3.5	2	2	2	2
	2.2	FRN0011E2■-7□	3.5	5.5	2	2	3.5	2

The recommended wire sizes for the main circuit terminals assume using 60°C IV wire.

- *1 For compatible crimped terminals, please use model 8-L6 by JST Mfg. Co., Ltd. or equivalent.
- *2 For compatible crimped terminals, please use model CB100-S8 by JST Mfg. Co., Ltd. or equivalent.
- *3 For compatible crimped terminals, please use model 22-S5 by JST Mfg. Co., Ltd. or equivalent.
- *4 For compatible crimped terminals, please use model 38-S6 by JST Mfg. Co., Ltd. or equivalent.
- *5 For compatible crimped terminals, please use model CB60-S6 by JST Mfg. Co., Ltd. or equivalent.
- *7 For compatible crimped terminals, please use model 38-6 by JST Mfg. Co., Ltd. or equivalent.
- *8 For compatible crimped terminals, please use model 60-6 by JST Mfg. Co., Ltd. or equivalent.

5) Ambient temperature: Below 50°C, Wire type: 75°C wire

Table 2.2-22 Recommended Wire Sizes, Ambient temperature: Below 50°C, Wire type: 75°C wire

ND Mode, Ambient temperature: Below 50°C, Wire type: 75°C wire

Power System	Std Applicable Motor (kW)	Inverter type	Recommended wire size (mm ²)					
			Main power supply input (Note 1) [L1/R, L2/S, L3/T]		Ground terminal (Note 1) [G]	Inverter output (Note 1) [U, V, W]	For DC reactor connection (Note 1) [P1, P(+)]	For braking resistor connection [P(+), DB]
			With DC reactor	Without DC reactor				
Three-phase 400 V	0.75	FRN0002E2■-4□	2	2	2	2	2	2
	1.5	FRN0004E2■-4□	2	2	2	2	2	2
	2.2	FRN0006E2■-4□	2	2	2	2	2	2
	3.0	FRN0007E2■-4□	2	2	2	2	2	2
	5.5	FRN0012E2■-4□	2	2	2	2	2	2
	11	FRN0022E2■-4□	2	3.5	3.5	2	2	2
	15	FRN0029E2■-4□	2	5.5	5.5	2	2	2
	18.5	FRN0037E2■-4□	3.5	5.5	5.5	3.5	3.5	2
	22	FRN0044E2■-4□	5.5	8	5.5	5.5	5.5	2
	30	FRN0059E2■-4□	8 ^{*1}	14	8 ^{*1}	8 ^{*1}	14	2
	37	FRN0072E2■-4□	8 ^{*1}	14	8 ^{*1}	14	14	2
	45	FRN0085E2■-4□	14	22	8	14	22	-
	55	FRN0105E2■-4□	22	38	14	22	22	-
	75	FRN0139E2■-4□	38	-	14	38	38	-
	90	FRN0168E2■-4□	38	-	14	38	60	-
	110	FRN0203E2■-4□	60	-	22	60	60	-
	132	FRN0240E2■-4□	60	-	22	60	100	-
	160	FRN0290E2■-4□	100	-	22	100	150 ^{*3}	-
200	FRN0361E2■-4□	150	-	38	150	150	-	
220	FRN0415E2■-4□	150	-	38	150	200	-	
280	FRN0520E2■-4□	200	-	38	200	250	-	
315	FRN0590E2■-4□	250	-	60	250	325	-	

HD Mode, Ambient temperature: Below 50°C, Wire type: 75°C wire

Power System	Std Applicable Motor (kW)	Inverter type	Recommended wire size (mm ²)					
			Main power supply input (Note 1) [L1/R, L2/S, L3/T]		Ground terminal (Note 1) [G]	Inverter output (Note 1) [U, V, W]	For DC reactor connection (Note 1) [P1, P(+)]	For braking resistor connection [P(+), DB]
			With DC reactor	Without DC reactor				
Three-phase 400 V	0.75	FRN0002E2■-4□	2	2	2	2	2	2
	1.1	FRN0004E2■-4□	2	2	2	2	2	2
	2.2	FRN0006E2■-4□	2	2	2	2	2	2
	3.0	FRN0007E2■-4□	2	2	2	2	2	2
	5.5	FRN0012E2■-4□	2	2	2	2	2	2
	7.5	FRN0022E2■-4□	2	2	2	2	2	2
	11	FRN0029E2■-4□	2	3.5	3.5	2	2	2
	15	FRN0037E2■-4□	2	5.5	5.5	3.5	2	2
	18.5	FRN0044E2■-4□	3.5	5.5	5.5	3.5	3.5	2
	22	FRN0059E2■-4□	5.5	8 ^{*1}	5.5	5.5	5.5	2
	30	FRN0072E2■-4□	8 ^{*1}	14	8 ^{*1}	8 ^{*1}	14	2
	37	FRN0085E2■-4□	8	14	8	14	14	-
	45	FRN0105E2■-4□	14	22	8	14	22	-
	55	FRN0139E2■-4□	22	38	14	22	22	-
	75	FRN0168E2■-4□	38	-	14	38	38	-
	90	FRN0203E2■-4□	38	-	14	38	60	-
	110	FRN0240E2■-4□	60	-	22	60	60	-
	132	FRN0290E2■-4□	60	-	22	100	100	-
160	FRN0361E2■-4□	100	-	22	100	150	-	
200	FRN0415E2■-4□	150	-	38	150	150	-	
220	FRN0520E2■-4□	150	-	38	150	200	-	
250	FRN0590E2■-4□	150	-	38	200	250	-	

Note 1) The rated current must be reduced for operation (Rated current x 80%). Recommended wire sizes assume these conditions.

The recommended wire sizes for the main circuit terminals assume using 75°C 600 V HIV wire.

*1 For compatible crimped terminals, please use model 8-L6 by JST Mfg. Co., Ltd. or equivalent.

*3 For compatible crimped terminals, please use model CB150-10 by JST Mfg. Co., Ltd. or equivalent.

Table 2.2-23 Recommended Wire Sizes, Ambient temperature: Below 50°C, Wire type: 75°C wire (continued)

HND Mode, Ambient temperature: Below 50°C, Wire type: 75°C wire

Power System	Std Applicable Motor (kW)	Inverter type	Recommended wire size (mm ²)					
			Main power supply input [L1/R, L2/S, L3/T]		Ground terminal [G]	Inverter output [U, V, W]	For DC reactor connection [P1, P(+)]	For braking resistor connection [P(+), DB]
			With DC reactor	Without DC reactor				
Three-phase 200 V	0.2	FRN0001E2■-2□	2	2	2	2	2	2
	0.4	FRN0002E2■-2□	2	2	2	2	2	2
	0.75	FRN0004E2■-2□	2	2	2	2	2	2
	1.1	FRN0006E2■-2□	2	2	2	2	2	2
	2.2	FRN0010E2■-2□	2	2	2	2	2	2
	3.0	FRN0012E2■-2□ ^{*10}	2	2	2	2	2	2
	5.5	FRN0020E2■-2□ ^{*10}	2	3.5	3.5	2	3.5	2
	7.5	FRN0030E2■-2□	3.5	5.5	5.5	3.5	5.5	2
	11	FRN0040E2■-2□	5.5	14	5.5	5.5	8	2
	15	FRN0056E2■-2□	14	14	5.5	14	14	2
	18.5	FRN0069E2■-2□	14	22	8	14	22	2
	22	FRN0088E2■-2□	22	38 ^{*7}	8	22	22	2
30	FRN0115E2■-2□	38 ^{*7}	60 ^{*8}	14	38 ^{*7}	38 ^{*7}	2	
Three-phase 400 V	0.75	FRN0002E2■-4□	2	2	2	2	2	2
	1.1	FRN0004E2■-4□	2	2	2	2	2	2
	2.2	FRN0006E2■-4□	2	2	2	2	2	2
	3.0	FRN0007E2■-4□ ^{*10}	2	2	2	2	2	2
	5.5	FRN0012E2■-4□ ^{*10}	2	2	2	2	2	2
	7.5	FRN0022E2■-4□	2	2	2	2	2	2
	11	FRN0029E2■-4□	2	3.5	3.5	2	3.5	2
	15	FRN0037E2■-4□	3.5	5.5	3.5	5.5	5.5	2
	18.5	FRN0044E2■-4□	5.5	8	5.5	5.5	5.5	2
	22	FRN0059E2■-4□	5.5	14	5.5	8 ^{*1}	8 ^{*1}	2
	30	FRN0072E2■-4□	14	14	8 ^{*1}	14	14	2
	37	FRN0085E2■-4□	14	22	8	14	22	-
	45	FRN0105E2■-4□	22	38	8	22	22	-
	55	FRN0139E2■-4□	22	38	14	38	38	-
	75	FRN0168E2■-4□	38	-	14	60	60	-
	90	FRN0203E2■-4□	60	-	14	60	100	-
	110	FRN0240E2■-4□	100	-	22	100	100	-
132	FRN0290E2■-4□	100	-	22	100	150 ^{*3}	-	
160	FRN0361E2■-4□	150	-	22	150	150	-	
200	FRN0415E2■-4□	150	-	38	200	250	-	
220	FRN0520E2■-4□	200	-	38	200	250	-	
280	FRN0590E2■-4□	250	-	38	325	200×2	-	

Note 1) The rated current must be reduced for operation (Rated current x 80%). Recommended wire sizes assume these conditions.

The recommended wire sizes for the main circuit terminals assume using 75°C 600 V HIV wire.

- *1 For compatible crimped terminals, please use model 8-L6 by JST Mfg. Co., Ltd. or equivalent.
- *3 For compatible crimped terminals, please use model CB150-10 by JST Mfg. Co., Ltd. or equivalent.
- *7 For compatible crimped terminals, please use model 38-6 by JST Mfg. Co., Ltd. or equivalent.
- *8 For compatible crimped terminals, please use model 60-6 by JST Mfg. Co., Ltd. or equivalent.
- *10 ND-spec.

Table 2.2-24 Recommended Wire Sizes, Ambient temperature: Below 50°C, Wire type: 75°C wire (continued)

HHD Mode, Ambient temperature: Below 50°C, Wire type: 75°C wire

Power System	Std Applicable Motor (kW)	Inverter type	Recommended wire size (mm ²)					
			Main power supply input [L1/R, L2/S, L3/T]		Ground terminal [G]	Inverter output [U, V, W]	For DC reactor connection [P1, P(+)]	For braking resistor connection [P(+), DB]
			With DC reactor	Without DC reactor				
Three-phase 200 V	0.1	FRN0001E2-2□	2	2	2	2	2	2
	0.2	FRN0002E2-2□	2	2	2	2	2	2
	0.4	FRN0004E2-2□	2	2	2	2	2	2
	0.75	FRN0006E2-2□	2	2	2	2	2	2
	1.5	FRN0010E2-2□	2	2	2	2	2	2
	2.2	FRN0012E2-2□	2	2	2	2	2	2
	3.7	FRN0020E2-2□	2	2	2	2	2	2
	5.5	FRN0030E2-2□	2	3.5	3.5	3.5	3.5	2
	7.5	FRN0040E2-2□	3.5	5.5	5.5	3.5	5.5	2
	11	FRN0056E2-2□	5.5	14	5.5	8	8	2
	15	FRN0069E2-2□	14	14	5.5	14	14	2
	18.5	FRN0088E2-2□	14	22	8	14	22	2
22	FRN0115E2-2□	22	38 ^{*7}	8	22	22	2	
Three-phase 400 V	0.4	FRN0002E2-4□	2	2	2	2	2	2
	0.75	FRN0004E2-4□	2	2	2	2	2	2
	1.5	FRN0006E2-4□	2	2	2	2	2	2
	2.2	FRN0007E2-4□	2	2	2	2	2	2
	3.7	FRN0012E2-4□	2	2	2	2	2	2
	5.5	FRN0022E2-4□	2	2	2	2	2	2
	7.5	FRN0029E2-4□	2	2	2	2	2	2
	11	FRN0037E2-4□	2	3.5	3.5	2	3.5	2
	15	FRN0044E2-4□	3.5	5.5	5.5	3.5	5.5	2
	18.5	FRN0059E2-4□	5.5	8 ^{*1}	5.5	5.5	5.5	2
	22	FRN0072E2-4□	5.5	14	5.5	8 ^{*1}	8 ^{*1}	2
	30	FRN0085E2-4□	14	14	8	14	14	-
	37	FRN0105E2-4□	14	22	8	14	22	-
	45	FRN0139E2-4□	22	38	8	22	22	-
	55	FRN0168E2-4□	22	38	14	38	38	-
	75	FRN0203E2-4□	38	-	14	60	60	-
	90	FRN0240E2-4□	60	-	14	60	100	-
110	FRN0290E2-4□	100	-	22	100	100	-	
132	FRN0361E2-4□	100	-	22	100	150	-	
160	FRN0415E2-4□	150	-	22	150	150	-	
200	FRN0520E2-4□	150	-	38	200	250	-	
220	FRN0590E2-4□	200	-	38	200	250	-	
Single-phase 200 V	0.1	FRN0001E2-7□	2	2	2	2	2	2
	0.2	FRN0002E2-7□	2	2	2	2	2	2
	0.4	FRN0003E2-7□	2	2	2	2	2	2
	0.75	FRN0005E2-7□	2	2	2	2	2	2
	1.5	FRN0008E2-7□	2	2	2	2	2	2
	2.2	FRN0011E2-7□	2	3.5	2	2	2	2

The recommended wire sizes for the main circuit terminals assume using 75°C 600 V HIV wire.

- *1 For compatible crimped terminals, please use model 8-L6 by JST Mfg. Co., Ltd. or equivalent.
- *3 For compatible crimped terminals, please use model CB150-10 by JST Mfg. Co., Ltd. or equivalent.
- *7 For compatible crimped terminals, please use model 38-6 by JST Mfg. Co., Ltd. or equivalent.

6) Ambient temperature: Below 50°C, Wire type: 90°C wire

Table 2.2-25 Recommended Wire Sizes, Ambient temperature: Below 50°C, Wire type: 90°C wire

ND Mode, Ambient temperature: Below 50°C, Wire type: 90°C wire

Power System	Std Applicable Motor (kW)	Inverter type	Recommended wire size (mm ²)					
			Main power supply input (Note 1) [L1/R, L2/S, L3/T]		Ground terminal (Note 1) [⊕G]	Inverter output (Note 1) [U, V, W]	For DC reactor connection (Note 1) [P1, P(+)]	For braking resistor connection [P(+), DB]
			With DC reactor	Without DC reactor				
Three-phase 400 V	0.75	FRN0002E2■-4□	2	2	2	2	2	2
	1.5	FRN0004E2■-4□	2	2	2	2	2	2
	2.2	FRN0006E2■-4□	2	2	2	2	2	2
	3.0	FRN0007E2■-4□	2	2	2	2	2	2
	5.5	FRN0012E2■-4□	2	2	2	2	2	2
	11	FRN0022E2■-4□	2	3.5	3.5	2	2	2
	15	FRN0029E2■-4□	2	5.5	5.5	2	3.5	2
	18.5	FRN0037E2■-4□	3.5	5.5	5.5	3.5	5.5	2
	22	FRN0044E2■-4□	5.5	8	5.5	5.5	5.5	2
	30	FRN0059E2■-4□	5.5	8 ^{*1}	8 ^{*1}	5.5	5.5	2
	37	FRN0072E2■-4□	5.5	14	8 ^{*1}	8 ^{*1}	8 ^{*1}	2
	45	FRN0085E2■-4□	8	14	8	8	14	-
	55	FRN0105E2■-4□	14	22	14	14	14	-
	75	FRN0139E2■-4□	22	-	14	22	38	-
	90	FRN0168E2■-4□	22	-	14	38	38	-
	110	FRN0203E2■-4□	38	-	22	38	60	-
	132	FRN0240E2■-4□	60	-	22	60	60	-
	160	FRN0290E2■-4□	60	-	22	60	100	-
	200	FRN0361E2■-4□	100	-	38	100	150	-
	220	FRN0415E2■-4□	100	-	38	100	150	-
280	FRN0520E2■-4□	150	-	38	150	200	-	
315	FRN0590E2■-4□	150	-	60	200	250	-	

Note 1) The rated current must be reduced for operation (Rated current x 80%). Recommended wire sizes assume these conditions.

HD Mode, Ambient temperature: Below 50°C, Wire type: 90°C wire

Power System	Std Applicable Motor (kW)	Inverter type	Recommended wire size (mm ²)					
			Main power supply input (Note 1) [L1/R, L2/S, L3/T]		Ground terminal (Note 1) [⊕G]	Inverter output (Note 1) [U, V, W]	For DC reactor connection (Note 1) [P1, P(+)]	For braking resistor connection [P(+), DB]
			With DC reactor	Without DC reactor				
Three-phase 400 V	0.75	FRN0002E2■-4□	2	2	2	2	2	2
	1.1	FRN0004E2■-4□	2	2	2	2	2	2
	2.2	FRN0006E2■-4□	2	2	2	2	2	2
	3.0	FRN0007E2■-4□	2	2	2	2	2	2
	5.5	FRN0012E2■-4□	2	2	2	2	2	2
	7.5	FRN0022E2■-4□	2	2	2	2	2	2
	11	FRN0029E2■-4□	2	3.5	3.5	2	2	2
	15	FRN0037E2■-4□	2	5.5	5.5	2	3.5	2
	18.5	FRN0044E2■-4□	3.5	5.5	5.5	3.5	5.5	2
	22	FRN0059E2■-4□	3.5 ^{*4}	5.5	5.5	3.5 ^{*4}	3.5 ^{*4}	2
	30	FRN0072E2■-4□	5.5	8 ^{*1}	8 ^{*1}	5.5	5.5	2
	37	FRN0085E2■-4□	5.5	14	8	8	8	-
	45	FRN0105E2■-4□	8	14	8	14	14	-
	55	FRN0139E2■-4□	14	22	14	14	14	-
	75	FRN0168E2■-4□	22	-	14	22	38	-
	90	FRN0203E2■-4□	22	-	14	38	38	-
	110	FRN0240E2■-4□	38	-	22	38	60	-
	132	FRN0290E2■-4□	60	-	22	60	60	-
	160	FRN0361E2■-4□	60	-	22	60	100	-
	200	FRN0415E2■-4□	100	-	38	100	150	-
220	FRN0520E2■-4□	100	-	38	100	150	-	
250	FRN0590E2■-4□	150	-	38	150	150	-	

Note 1) The rated current must be reduced for operation (Rated current x 80%). Recommended wire sizes assume these conditions.

The recommended wire sizes for the main circuit terminals assume using 90°C 600 V FSLC wire.

*1 For compatible crimped terminals, please use model 8-L6 by JST Mfg. Co., Ltd. or equivalent.

*4 For compatible crimped terminals, please use model R5.5-6 by JST Mfg. Co., Ltd. or equivalent.

Table 2.2-26 Recommended Wire Sizes, Ambient temperature: Below 50°C, Wire type: 90°C wire (continued)

HND Mode, Ambient temperature: Below 50°C, Wire type: 90°C wire

Power System	Std Applicable Motor (kW)	Inverter type	Recommended wire size (mm ²)					
			Main power supply input [L1/R, L2/S, L3/T]		Ground terminal [G]	Inverter output [U, V, W]	For DC reactor connection [P1, P(+)]	For braking resistor connection [P(+), DB]
			With DC reactor	Without DC reactor				
Three-phase 200 V	0.2	FRN0001E2■-2□	2	2	2	2	2	2
	0.4	FRN0002E2■-2□	2	2	2	2	2	2
	0.75	FRN0004E2■-2□	2	2	2	2	2	2
	1.1	FRN0006E2■-2□	2	2	2	2	2	2
	2.2	FRN0010E2■-2□	2	2	2	2	2	2
	3.0	FRN0012E2■-2□ ^{*10}	2	2	2	2	2	2
	5.5	FRN0020E2■-2□ ^{*10}	2	3.5	3.5	2	2	2
	7.5	FRN0030E2■-2□	2	5.5	5.5	2	3.5	2
	11	FRN0040E2■-2□	5.5	8	5.5	3.5	5.5	2
	15	FRN0056E2■-2□	8	14	5.5	5.5	14	2
	18.5	FRN0069E2■-2□	14	14	8	8	14	2
	22	FRN0088E2■-2□	14	22	8	14	22	2
30	FRN0115E2■-2□	22	38 ^{*7}	14	22	38 ^{*7}	2	
Three-phase 400 V	0.75	FRN0002E2■-4□	2	2	2	2	2	2
	1.1	FRN0004E2■-4□	2	2	2	2	2	2
	2.2	FRN0006E2■-4□	2	2	2	2	2	2
	3.0	FRN0007E2■-4□ ^{*10}	2	2	2	2	2	2
	5.5	FRN0012E2■-4□ ^{*10}	2	2	2	2	2	2
	7.5	FRN0022E2■-4□	2	2	2	2	2	2
	11	FRN0029E2■-4□	2	3.5	3.5	2	2	2
	15	FRN0037E2■-4□	2	5.5	3.5	3.5	3.5	2
	18.5	FRN0044E2■-4□	3.5	5.5	5.5	3.5	5.5	2
	22	FRN0059E2■-4□	5.5	8 ^{*1}	5.5	5.5	5.5	2
	30	FRN0072E2■-4□	8 ^{*1}	14	8 ^{*1}	8 ^{*1}	8 ^{*1}	2
	37	FRN0085E2■-4□	8	14	8	14	14	-
	45	FRN0105E2■-4□	14	22	8	14	22	-
	55	FRN0139E2■-4□	22	38	14	22	22	-
	75	FRN0168E2■-4□	38	-	14	38	38	-
	90	FRN0203E2■-4□	38	-	14	38	60	-
	110	FRN0240E2■-4□	60	-	22	60	60	-
	132	FRN0290E2■-4□	60	-	22	100	100	-
160	FRN0361E2■-4□	100	-	22	100	150	-	
200	FRN0415E2■-4□	150	-	38	150	150	-	
220	FRN0520E2■-4□	150	-	38	150	200	-	
280	FRN0590E2■-4□	200	-	38	200	250	-	

The recommended wire sizes for the main circuit terminals assume using 90°C 600 V FSLC wire.

*1 For compatible crimped terminals, please use model 8-L6 by JST Mfg. Co., Ltd. or equivalent.

*4 For compatible crimped terminals, please use model R5.5-6 by JST Mfg. Co., Ltd. or equivalent.

*7 For compatible crimped terminals, please use model 38-6 by JST Mfg. Co., Ltd. or equivalent.

*10 ND-spec

Table 2.2-27 Recommended Wire Sizes, Ambient temperature: Below 50°C, Wire type: 90°C wire (continued)

HHD Mode, Ambient temperature: Below 50°C, Wire type: 90°C wire

Power System	Std Applicable Motor (kW)	Inverter type	Recommended wire size (mm ²)					
			Main power supply input [L1/R, L2/S, L3/T]		Ground terminal [G]	Inverter output [U, V, W]	For DC reactor connection [P1, P(+)]	For braking resistor connection [P(+), DB]
			With DC reactor	Without DC reactor				
Three-phase 200 V	0.1	FRN0001E2-2□	2	2	2	2	2	2
	0.2	FRN0002E2-2□	2	2	2	2	2	2
	0.4	FRN0004E2-2□	2	2	2	2	2	2
	0.75	FRN0006E2-2□	2	2	2	2	2	2
	1.5	FRN0010E2-2□	2	2	2	2	2	2
	2.2	FRN0012E2-2□	2	2	2	2	2	2
	3.7	FRN0020E2-2□	2	2	2	2	2	2
	5.5	FRN0030E2-2□	2	3.5	3.5	2	2	2
	7.5	FRN0040E2-2□	2	5.5	5.5	3.5	3.5	2
	11	FRN0056E2-2□	5.5	8	5.5	5.5	5.5	2
	15	FRN0069E2-2□	8	14	5.5	8	14	2
	18.5	FRN0088E2-2□	14	14	8	14	14	2
22	FRN0115E2-2□	14	22	8	14	22	2	
Three-phase 400 V	0.4	FRN0002E2-4□	2	2	2	2	2	2
	0.75	FRN0004E2-4□	2	2	2	2	2	2
	1.5	FRN0006E2-4□	2	2	2	2	2	2
	2.2	FRN0007E2-4□	2	2	2	2	2	2
	3.7	FRN0012E2-4□	2	2	2	2	2	2
	5.5	FRN0022E2-4□	2	2	2	2	2	2
	7.5	FRN0029E2-4□	2	2	2	2	2	2
	11	FRN0037E2-4□	2	3.5	3.5	2	2	2
	15	FRN0044E2-4□	2	5.5	5.5	2	3.5	2
	18.5	FRN0059E2-4□	3.5 ^{*4}	5.5	5.5	3.5 ^{*4}	5.5	2
	22	FRN0072E2-4□	5.5	8 ^{*1}	5.5	5.5	5.5	2
	30	FRN0085E2-4□	8	14	8	8	8	-
	37	FRN0105E2-4□	8	14	8	14	14	-
	45	FRN0139E2-4□	14	22	8	14	22	-
	55	FRN0168E2-4□	22	38	14	22	22	-
	75	FRN0203E2-4□	38	-	14	38	38	-
	90	FRN0240E2-4□	38	-	14	38	60	-
110	FRN0290E2-4□	60	-	22	60	60	-	
132	FRN0361E2-4□	60	-	22	100	100	-	
160	FRN0415E2-4□	100	-	22	100	150	-	
200	FRN0520E2-4□	150	-	38	150	150	-	
220	FRN0590E2-4□	150	-	38	150	200	-	
Single-phase 200 V	0.1	FRN0001E2-7□	2	2	2	2	2	2
	0.2	FRN0002E2-7□	2	2	2	2	2	2
	0.4	FRN0003E2-7□	2	2	2	2	2	2
	0.75	FRN0005E2-7□	2	2	2	2	2	2
	1.5	FRN0008E2-7□	2	2	2	2	2	2
	2.2	FRN0011E2-7□	2	2	2	2	2	2

The recommended wire sizes for the main circuit terminals assume using 90°C 600 V FSLC wire.



*1 For compatible crimped terminals, please use model 8-L6 by JST Mfg. Co., Ltd. or equivalent.

*4 For compatible crimped terminals, please use model R5.5-6 by JST Mfg. Co., Ltd. or equivalent.

[4] Description of terminal functions (main circuit terminal)

Classification	Terminal symbol	Terminal name	Specification
Main circuit	L1/R, L2/S, L3/T	Main power input	Terminals to connect Three-phase power source.
	L1/L, L2/N	Main power input	Terminals to connect Single-phase power source.
	U, V, W	Inverter output	Terminals to connect Three-phase motors.
	P (+), P1	For direct current reactor connection	Terminals to connect DC reactor (DCR) for power factor enhancement. It must be connected in the following cases: ND mode: Types FRN0139E2■-4□ or above. HD/HND mode: Types FRN0168E2■-4□ or above. HHD mode: Types FRN0203E2■-4□ or above.
	P (+), N (-)	For direct current bus connection	Terminals to connect direct current intermediate circuit of other inverters and PWM converters.
	P (+), DB	For braking resistor connection	Terminals to connect a braking resistor (optional). Wiring length: Below 5 meters. (Types FRN0115E2■-2□/FRN0072E2■-4□/FRN0011E2■-7□ or below)
	 G	For inverter chassis (case) grounding	Grounding terminal for inverter chassis (case).
	R0, T0	Auxiliary power input for control circuit	When it is desired to retain the alarm signal for the activation of the protective function even inverter main power supply shut off or when continuous display of the keypad is desired, connect this terminal to the power supply. (Types FRN0088E2■-4□/FRN0059E2■-4□ or above)
	R1, T1	Auxiliary power input for fan	Ordinarily, these terminals do not need to be connected. Connect these terminals to AC power supply when operating with direct current power input (such as in combination with PWM converters). (Types FRN0203E2■-4□ or above)

Follow the sequence below when wiring.

- (1) Inverter ground terminal (G)
- (2) Inverter output terminals (U, V, W), motor ground terminal (G)
- (3) Direct current reactor connection terminals (P1, P(+))*
- (4) Braking resistor connection terminals (P(+), DB)*
- (5) Direct current bus connection terminals (P(+), N(-))*
- (6) Main power supply input terminals (L1/R, L2/S, L3/T) or (L1/L, L2/N)
- (7) Auxiliary power input for control circuit (R0, T0) *

*: Connect if necessary.

Connect in the order (1), (2), (6), (3), (4), (5), (7) for the following models.

FRN0010 to 0020E2S-2□, FRN0002 to 0012E2S-4□, FRN0008 to 0011E2S-7□

(1) Main power source input terminals L1/R, L2/S, L3/T (Three-phase input) or L1/L, L2/N (Single-phase input)

Connect the Three-phase power source for Three-phase input model. Connect the Single-phase power source for Single-phase input model.

- 1) For safety, confirm that the circuit breaker (MCCB) or the magnetic contactor (MC) is OFF prior to wiring the power lines.
- 2) Connect the power lines (L1/R, L2/S, L3/T) or (L1/L, L2/N) to MCCB or residual-current-operated protective device (RCD)/ the earth leakage breaker (ELCB)*, or connect via MC if necessary. The phase sequence of the power lines and the inverter do not need to be matched.

*: With overcurrent protection

Tip In emergencies such as when the inverter protective function is activated, disconnecting the inverter from the power source to prevent magnification of failure or accident may be desired. Installation of an MC which allows manual disconnection of the power source is recommended.

(2) Inverter output terminals U, V, W, motor ground terminal (⊕G)

- 1) Connect the Three-phase motor terminals U, V, and W while matching the phase sequence.
- 2) Connect the ground line of the outputs (U, V, W) to the ground terminal (⊕G).

Note When multiple combinations of inverters and motors exist, do not use multi-core cables for the purpose of bundling the various wires.

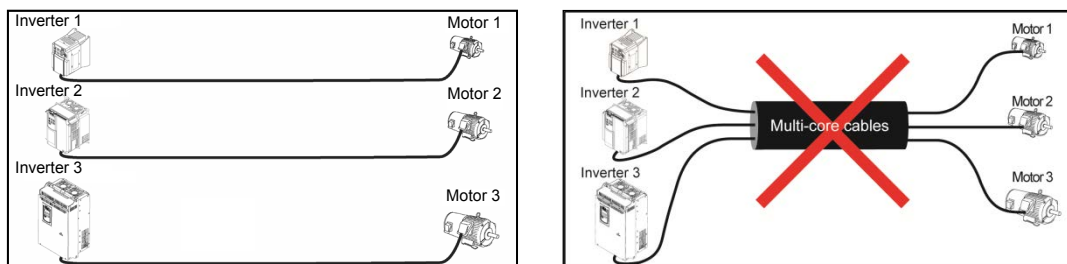

(3) Direct current reactor connection terminals P1, P(+)

Connect the direct current reactor (DCR) for power factor enhancement.

- 1) Remove the shorting bar from terminals P1-P(+).
(Types FRN0203E2■-4□ or above will not have the shorting bar connected.)
- 2) Connect the P1, P(+) terminals to the direct current reactor (option).

Note

- Keep the wiring length below 10 meters.
- Do not remove the shorting bar if the direct current reactor is not used.
- When the capacity of the motor to be used is above 75 kW, always connect the direct current reactor.
- Direct current reactors do not have to be connected when connecting PWM converters.

⚠ WARNING

Always connect the direct current reactor (option) when the power supply transformer capacity is above 500 kVA and is over 10 times the rated capacity of the inverter.

Risk of fire exists.

**(4) Braking resistor connection terminals P(+)-DB
(Types FRN0115E2■-2□ / FRN0072E2■-4□ / FRN0011E2■-7□ or below)**

- 1) Connect terminals P(+), DB of the inverter to braking resistor terminals (option).
- 2) Mount the inverter main body and the braking resistor such that the wiring length will be less than 5m (16ft) and route the two wires twisted or in contact with each other (parallel).

⚠ WARNING

Do not connect to terminals other than P(+)-DB when connecting braking resistors.

Risk of fire exists.

(5) Direct current bus terminals P(+), N(-)

1) Connecting the braking unit/braking resistor (option)

Inverter type	Braking transistor	Additional instruments for connection (option)	Instruments connected/connection terminals
Types FRN0085E2■-4□ or below	Not equipped	Braking unit	Inverter (P(+), N(-)) - Braking unit (P(+), N(-))
		Braking resistor	Braking unit (P(+) R, DB) - Braking resistor (P, DB)

Braking units are necessary when using braking resistors for types FRN0085E2■-4□ or above.

Connect terminals P(+), N(-) of the braking unit to the inverter terminals P(+), N(-). Mount the equipment such that the wiring length is below 5m (16ft) and route the two wires twisted or in contact with each other (parallel).

Connect the terminals P(+) R, DB of the braking unit to terminals P(+), DB of the braking resistor. Mount the equipment such that the wiring length is below 10m (33ft) and route the two wires twisted or in contact with each other (parallel).

For details such as other wirings, refer to the user's manual for the braking unit.

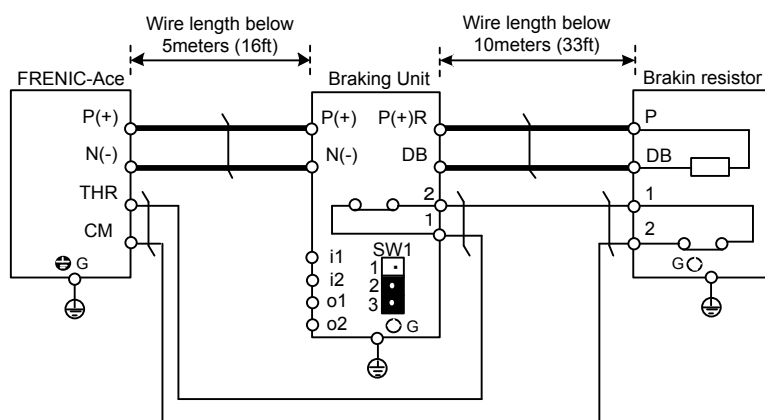

Figure 2.2-9

2) Connection of other instruments

The direct current intermediate circuit of other inverters and PWM converters can be connected.

(For connection with the PWM converter, refer to Chapter 11 "11.9 Power Regenerative PWM Converters, RHC Series").

(6) Inverter ground terminal ⚡G

This terminal is the ground terminal for the inverter chassis (case). Always connect to ground for safety and as a countermeasure for noise. To prevent accidents such as electric shock and fire, the electrical safety standards require grounding construction for metallic frames in electric instruments.

Follow the steps below in connecting the ground terminal on the power supply side.

- 1) Ground the inverter in compliance with the national or local electric code.
- 2) The grounding wire size should be as described before in this chapter, with large surface area, and as short as possible.

(7) Auxiliary power input terminals for control circuit R0, T0 (Types FRN008E2-2□ / FRN0059E2-4□ or above)

The inverter can be operated without power input to the auxiliary power input terminals for control circuit. However, the inverter output signals and the keypad display will be shut off when the inverter main power is shut off and the control power source is lost.

When it is desired to retain the alarm signal for the activation of the protective function even inverter main power supply shut off, or when continuous display of the keypad is desired, connect these terminals to the power supply. When the inverter input side has a magnetic contactor (MC), wire from the input side (primary side) of the magnetic contactor (MC).

Terminal rating: AC 200 to 240 V, 50/60 Hz, maximum current 1.0 A (200 V series)
 AC 380 to 480 V, 50/60 Hz, maximum current 0.5 A (400 V series)

Note When using the earth leakage breaker, connect terminals R0, T0 to the output side of the earth leakage breaker.

When connections are made to the input side of the earth leakage breaker, the earth leakage breaker will malfunction because the inverter input is three-phase and the terminals R0, T0 are single phase. When connecting to terminals R0, T0 to the input side of the earth leakage breaker, make sure that the connection is done through an insulating transformer or, alternatively, through the auxiliary B contacts of the magnetic contactor as shown in the figure below.

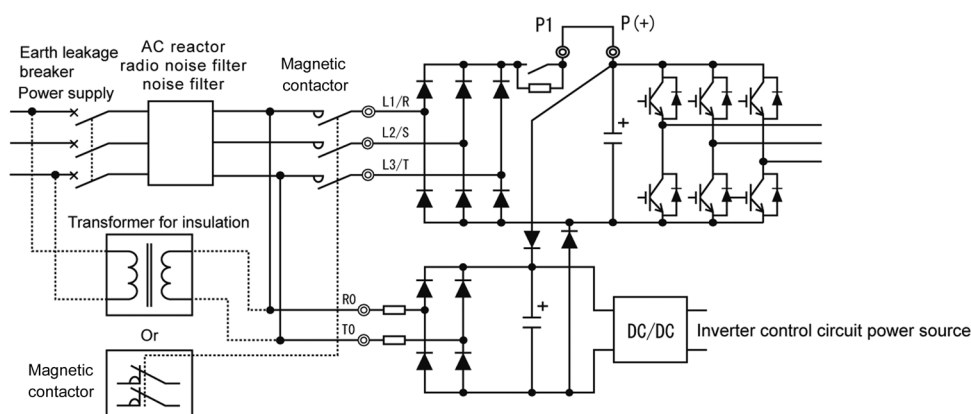

Figure 2.2-10 Connection of the Earth Leakage Breaker

Note When connecting with the PWM converter, do not connect power source directly to the inverter's auxiliary power input terminals (R0, T0) for control circuit. Insert an insulating transformer or the auxiliary B contacts of a magnetic contactor on the power supply side.

On connection examples for the PWM converter side, refer to Chapter 11 "11.9 Power Regenerative PWM Converters, RHC Series".

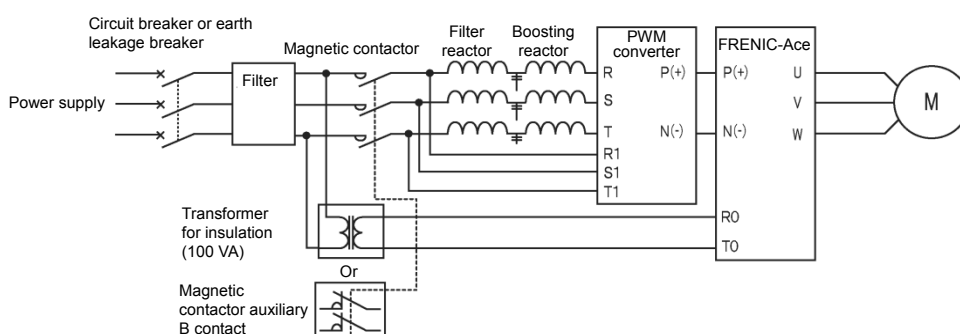

Figure 2.2-11 Example of connection of R0, T0 terminals in combination with PWM converter

(8) Auxiliary power input terminals for fan R1, T1 (Types FRN0203E2-4□ or above)

These terminals are equipped on types FRN0203E2-4□ or below, but are not used ordinarily.

Connect the AC power source when using direct current power supply input (such as in combination with PWM converters).

Also switch the fan power supply switching connectors "CN R", "CN W".

Terminal rating: AC 380 to 440 V/50 Hz, 380 to 480 V/60 Hz, maximum current 1.0 A (400 V series)

2.2.6 Control circuit terminals (common to all models)

[1] Screw specifications and recommended wire size (control circuit terminals)

The screw specifications and wire sizes to be used for control circuit wiring are shown below.
The control circuit terminal board differs depending on the destination.

Table 2.2-28 Screw Specifications and Recommended Wire Sizes

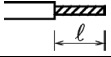
Terminal symbol	Screw specification		Allowable wire sizes	Driver (shape of tip)	Removal size of wire cover 	Gauge size to insert wire
	Size	Tightening torque				
30A, 30B, 30C EN1, EN2	M3	0.5 N·m (4.43 lb-in)	0.14 to 1.5 mm ² (AWG26 to 16)	Minus (0.6mm×3.5mm)	6 mm (0.24 in)	A1 ^{*1}
Others	M2	0.19 N·m (1.68 lb-in)	0.25 to 1 mm ² (AWG24 to 18)	Minus (0.4mm×2.5mm)	5 mm (0.20 in)	φ1.6

* Recommended rod terminal: Phoenix Contact Refer to Table 2.2-29 for details.

*1 Defined according to IEC/EN 60947-1.

Table 2.2-29 Recommended Rod Terminals

Screw size	Wire size	Type		
		With insulating collar	Without insulating collar	
M3	M2	0.25 mm ² (AWG24)	AI 0.25-6 BU	A 0.25-7
		0.34 mm ² (AWG22)	AI 0.34-6 TQ	A 0.34-7
		0.5 mm ² (AWG20)	AI 0.5-6 WH	A 0.5-6
	M3	0.75 mm ² (AWG18)	AI 0.75-6 GY	A 0.75-6
		1 mm ² (AWG18)	AI 1-6 RD	A 1-6
		1.5 mm ² (AWG16)	AI 1.5-6 BK	A 1.5-7

Note) When sizes exceeding the recommended wire sizes are used, the front cover may be pushed outward depending on the number of wires, causing erroneous operation of the keypad.

[2] Terminal layout diagram (control circuit terminal)

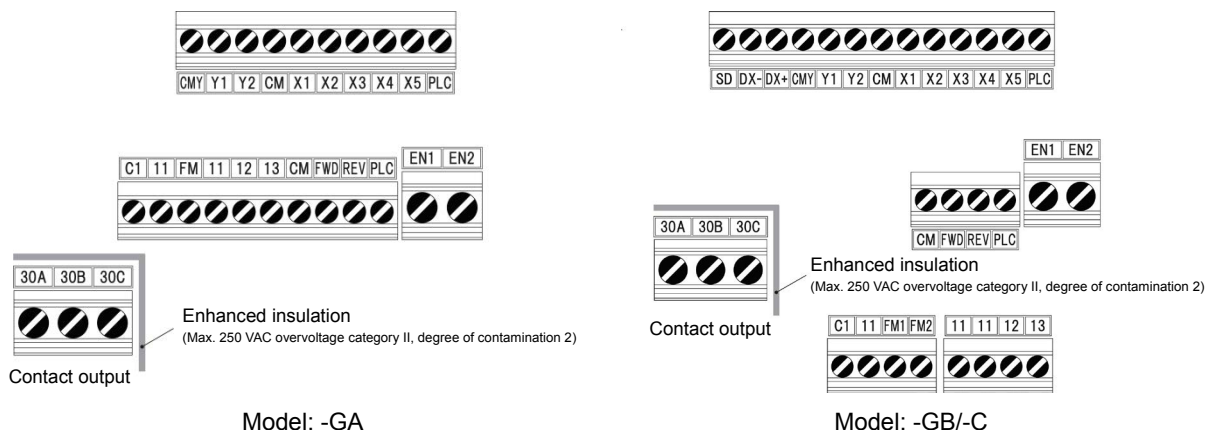



⚠ WARNING ⚠

The following terminals may have high voltage when the power is ON.
Control terminals: AUX-contact (30A, 30B, 30C)
Insulation level
Contact output – control circuit : Enhanced insulation (overvoltage category II, degree of contamination 2)

Risk of electric shock exists

[3] Description of terminal functions (control circuit terminal)

 WARNING 
<p>Generally, the insulation for control signal lines is not enhanced. When the control signal lines come into direct contact with the main circuit live section, the insulation cover may be damaged. High voltage of the main circuit may be applied on the control signal lines, so exercise caution such that the main circuit live sections do not contact the control signal lines.</p> <p>Risk of accidents and risk of electric shock exist.</p>

 CAUTION
<p>Noise is generated by the inverter, motor, and wiring. Exercise caution to prevent malfunction of peripheral sensors and instruments.</p> <p>Risk of accidents exists.</p>

Table 2.2-30 shows the functional explanations for the control circuit terminals. The connection method of the control circuit terminals differs depending on the functional code setting matching the purpose of inverter operation. Properly wire such that the impact of noise generated by the main circuit wiring is reduced.

Table 2.2-30 Functional Description of Control Circuit Terminals

Classification	Terminal symbol	Terminal name	Functional description
Analog input	[13]	Power supply for the potentiometer	The terminal is used for the power supply (DC+10 V 10 mA Max) for the external frequency command potentiometer (variable resistor: 1 to 5 kΩ). Connect variable resistors larger than 1/2 W.
	[12]	Analog setup voltage input	(1) Frequency is set up according to the external analog voltage input command value. Normal operation <ul style="list-style-type: none"> • DC0 to +10 V/0 to 100(%) (DC0 to +5 V/0 to 100%) • DC0 to ±10 V/0 to ±100(%) (DC0 to ±5 V/0 to ±100%) Reverse operation <ul style="list-style-type: none"> • DC+10 to 0V/0 to 100(%) (DC+5 to 0 V/0 to 100%) • DC±10 to 0V/0 to ±100(%) (DC±5 to 0V/0 to ±100%) (2) The terminal can be assigned to PID command, feedback signal of PID control, auxiliary frequency setup, ratio setup, torque limit setup, and analog input monitor aside from the frequency setup by analog input. (3) Hardware specification <ul style="list-style-type: none"> * Input impedance: 22 (kΩ) * Up to DC±15 V can be input. However, input exceeding DC±10 V will be recognized as DC±10 V.
	[C1]	Analog setup current input (C1 function)	(1) Frequency is set up according to the external analog current input command value. Normal operation <ul style="list-style-type: none"> • DC4 to 20 mA/0 to 100(%)/-100% to 0 to 100% • DC0 to 20 mA/0 to 100(%)/-100% to 0 to 100% Reverse operation <ul style="list-style-type: none"> • DC20 to 4 mA/0 to 100(%)/-100% to 0 to 100% • DC20 to 0 mA/0 to 100(%)/-100% to 0 to 100% (2) The terminal can be assigned to PID command, feedback signal of PID control, auxiliary frequency setup, ratio setup, torque limit setup, and analog input monitor aside from the frequency setup by analog input. (3) Hardware specification <ul style="list-style-type: none"> * Input impedance: 250 (Ω) * Up to DC 30 mA can be input. However, input exceeding DC 20 mA will be recognized as DC 20 mA.

Table 2.2-30 Functional Description of Control Circuit Terminals (continued)

Classification	Terminal symbol	Terminal name	Functional description
Analog input	[C1]	Analog setup voltage input (V2 function)	<p>(1) Frequency is set up according to the external analog voltage input command value. SW3 (refer to “2.2.8 Operating slide switches”) must be switched on the printed circuit board.</p> <p>Normal operation</p> <ul style="list-style-type: none"> • DC0 to +10 V/0 to 100% (DC0 to +5 V/0 to 100%) • DC0 to +10 V/-100 to 0 to 100% (DC0 to +5 V/-100 to 0 to 100%) <p>Reverse operation</p> <ul style="list-style-type: none"> • DC+10 to 0 V/0 to 100% (DC+5 V to 0 V/0 to 100%) • DC+10 to 0 V/-100 to 0 to 100% (DC+5 to 0 V/-100 to 0 to 100%) <p>(2) The terminal can be assigned to PID command, feedback signal of PID control, auxiliary frequency setup, ratio setup, torque limit setup, and analog input monitor aside from the frequency setup by analog input.</p> <p>(3) Hardware specification</p> <ul style="list-style-type: none"> * Input impedance: 22(kΩ) * Up to DC+15 V can be input. However, input exceeding DC+10 V will be recognized as DC+10 V.
		PTC thermistor input (PTC function)	<p>(1) PTC (Positive Temperature Coefficient) thermistor for motor protection can be connected. SW3 (C1/V2 Switch) and SW4 (PTC /AI Switch) (refer to “2.2.8 Operating slide switches”) must be switched on the printed circuit board.</p> <p>Figure 2.2-12 shows the internal circuit when SW3 and SW4 are set for PTC thermistor input. For details on SW3 and SW4, refer to “2.2.8 Operating slide switches”. When SW3 and SW4 are switched to the PTC side, function codes H26 and H27 also needs to be changed.</p>  <p style="text-align: center;">Figure 2.2-12 Internal circuit when SW4 is switched to PTC side</p>
		Analog input monitor (AI function)	<p>(1) The analog input monitor can be used to monitor the status of peripheral instruments using communication by inputting the analog signals of various sensors such as temperature sensors. Data can be converted to physical property values such as temperature and pressure by using display factors and shown on the keypad display.</p>
	[11]	Analog input common	<p>The terminal is the common terminal for analog input signals (terminals [12], [13], [C1]). The terminal is insulated from terminals [CM], [CMY].</p>
<p>Note</p>	<ul style="list-style-type: none"> • Use shielded lines and keep the wiring to the minimum as possible (below 20 meters) for control signals which are susceptible to external noise. Grounding the shielded lines is generally recommended, but if external induction noise is large, connecting to terminal 11 may reduce the noise. The shielded line increases the blocking effect. Always ground one end as shown in Figure 2.2-13. • When inserting a relay contact at analog input signal lines, use the twin contacts relay for small signals. Also, do not insert a relay to terminal 11. • When external analog signal generators are connected, the analog signal generator circuit may malfunction due to the noise created by the inverter. In these cases, connect ferrite core (toroidal shape or equivalent) to the output terminals of the analog signal generator or connect high frequency capacitors between the control signal lines, as shown in Figure 2.2-14.   <p style="text-align: center;">Figure 2.2-13 Connection Diagram for Shielded Lines Figure 2.2-14 Example of Noise Countermeasures</p>		

Table 2.2-30 Functional Description of Control Circuit Terminals (continued)

Classification	Terminal symbol	Terminal name	Functional description																									
Digital input	[X1]	Digital input 1	(1) Various signals (coast to a stop command, external alarm, multi-speed selection, etc) set up by function codes E01 to E05, E98, E99 can be set up. For details, refer to Chapter 5 "FUNCTION CODES".																									
	[X2]	Digital input 2	(2) Input mode, sink/source can be switched using SW1. (Refer to "2.2.8 Operating slide switches")																									
	[X3]	Digital input 3	(3) The operating mode of the various digital input terminals when connected with terminal CM (sink mode) / PLC (source mode) can be switched to "ON when shorted with CM/PLC (active ON)" or "OFF when shorted with CM/PLC (active OFF)"																									
	[X4]	Digital input 4																										
	[X5]	Digital input 5/pulse train input	(4) Digital input terminal [X5] can be set up as a pulse train input terminal by changing the function code Maximum wiring length 20 meters Maximum input pulse																									
	[FWD]	Run forward command	30 kHz: When connected to open collector output pulse generator 100 kHz: When connected to complementary output pulse generator For function code settings, refer to Chapter 5 "FUNCTION CODES"																									
	[REV]	Run reverse command	<p><Digital input circuit specification></p>  <table border="1" data-bbox="901 853 1361 1176"> <thead> <tr> <th colspan="2">Item</th> <th>Minimum</th> <th>Maximum</th> </tr> </thead> <tbody> <tr> <td rowspan="2">Operating voltage (SINK)</td> <td>ON level</td> <td>0 V</td> <td>2 V</td> </tr> <tr> <td>OFF level</td> <td>22 V</td> <td>27 V</td> </tr> <tr> <td rowspan="2">Operating voltage (SOURCE)</td> <td>ON level</td> <td>22 V</td> <td>27 V</td> </tr> <tr> <td>OFF level</td> <td>0 V</td> <td>2 V</td> </tr> <tr> <td colspan="2">Operating current at ON (at input voltage 0 V) (for [X5] input terminal)</td> <td>2.5 mA (9.7 mA)</td> <td>5 mA (16 mA)</td> </tr> <tr> <td colspan="2">Allowable leak current at OFF</td> <td>-</td> <td>0.5 mA</td> </tr> </tbody> </table>	Item		Minimum	Maximum	Operating voltage (SINK)	ON level	0 V	2 V	OFF level	22 V	27 V	Operating voltage (SOURCE)	ON level	22 V	27 V	OFF level	0 V	2 V	Operating current at ON (at input voltage 0 V) (for [X5] input terminal)		2.5 mA (9.7 mA)	5 mA (16 mA)	Allowable leak current at OFF		-
Item		Minimum	Maximum																									
Operating voltage (SINK)	ON level	0 V	2 V																									
	OFF level	22 V	27 V																									
Operating voltage (SOURCE)	ON level	22 V	27 V																									
	OFF level	0 V	2 V																									
Operating current at ON (at input voltage 0 V) (for [X5] input terminal)		2.5 mA (9.7 mA)	5 mA (16 mA)																									
Allowable leak current at OFF		-	0.5 mA																									
	[EN1] [EN2]	Enable input	<p>(1) When terminals [EN1]-[PLC] or terminals [EN2]-[PLC] are OFF, the inverter output transistors stop switching (safe torque off: STO). Be sure to operate terminals [EN1] and [EN2] simultaneously; otherwise an <i>ECF</i> alarm is issued and the operation of the inverter will be disabled. To enable the Enable function, remove the shorting bar.</p> <p>(2) The input mode for terminals [EN1] and [EN2] is fixed to source. The mode cannot be switched to sink.</p> <p>(3) Short terminals [EN1]-[PLC] and [EN2] - [PLC] using shorting bars when the enable input function is not used (Keep the shorting bar connected).</p> <p><EN terminal circuit spec></p>  <table border="1" data-bbox="895 1608 1313 1809"> <thead> <tr> <th colspan="2">Item</th> <th>Min</th> <th>Max</th> </tr> </thead> <tbody> <tr> <td rowspan="2">Operating voltage (SOURCE)</td> <td>ON level</td> <td>22 V</td> <td>27 V</td> </tr> <tr> <td>OFF level</td> <td>0 V</td> <td>2 V</td> </tr> <tr> <td colspan="2">Operating current at ON (at input voltage 24 V)</td> <td>-</td> <td>4.5 mA</td> </tr> <tr> <td colspan="2">Allowable leak current at OFF</td> <td>-</td> <td>0.5 mA</td> </tr> </tbody> </table>	Item		Min	Max	Operating voltage (SOURCE)	ON level	22 V	27 V	OFF level	0 V	2 V	Operating current at ON (at input voltage 24 V)		-	4.5 mA	Allowable leak current at OFF		-	0.5 mA						
Item		Min	Max																									
Operating voltage (SOURCE)	ON level	22 V	27 V																									
	OFF level	0 V	2 V																									
Operating current at ON (at input voltage 24 V)		-	4.5 mA																									
Allowable leak current at OFF		-	0.5 mA																									
	[PLC]	Programmable controller signal power source	<p>(1) The terminal is used for connecting the output signal power source of the programmable controller (rated voltage DC +24 V (power supply voltage fluctuation range: DC +22 to +27 V) maximum 100 mA).</p> <p>(2) The terminal can also be used for the power source for the load connected to the transistor outputs. For details, refer to the page on "Transistor outputs".</p>																									

Table 2.2-30 Functional Description of Control Circuit Terminals (continued)

Classification	Terminal symbol	Terminal name	Functional description
Digital Input	[CM]	Digital common	This terminal is the common terminal for digital input signals. This terminal is insulated from terminals [11] and [CMY].
	<p>Tip ■ When turning terminals [FWD], [REV], [X1] to [X5] ON and OFF using relay contacts</p> <p>Figure 2.2-16 shows an example of the circuit configuration using relay contact. Circuit (a) in Figure 2.2-16 shows the circuit configuration when the switch (SW1) is on the sink side and circuit (b) shows the circuit configuration when the switch is on the source side.</p> <p>Caution: Use a relay which will not have contact failures (high contact reliability). (Recommended product: Fuji Electric's control relay type: HH54PW)</p> <div style="display: flex; justify-content: space-around;">   </div> <p style="text-align: center;">(a) Switch on sink side (b) Switch on source side</p> <p style="text-align: center;">Figure 2.2-16 Circuit Configuration Example Using Relay Contact</p>		
<p>Tip ■ When turning terminals [FWD], [REV], [X1] to [X5] ON and OFF using the programmable controller</p> <p>Figure 2.2-17 shows an example of the circuit configuration using programmable controller. Circuit (a) in Figure 2.2-17 shows the circuit configuration when the switch (SW1) is on the sink side and circuit (b) shows the circuit configuration when the switch is on the source side.</p> <p>In circuit (a), terminals [FWD], [REV], [X1] to [X5] can be turned ON/OFF by shorting/opening the open collector transistor output of the programmable controller using the external power supply. Follow the instructions below when using this type of circuit.</p> <ul style="list-style-type: none"> • Connect the + side of the external power supply which is insulated from the programmable controller power supply to terminal [PLC]. • Do not connect the inverter's [CM] terminal and the common terminal of the programmable controller. <div style="display: flex; justify-content: space-around;">   </div> <p style="text-align: center;">(a) Switch on the sink side (b) Switch on the source side</p> <p style="text-align: center;">Figure 2.2-17 Circuit Configuration Example Using Programmable Controller</p> <p>Refer to "2.2.8 Operating slide switches" for more information on the switches.</p>			

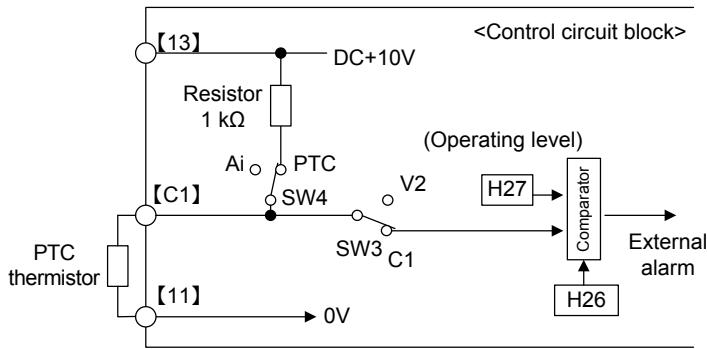
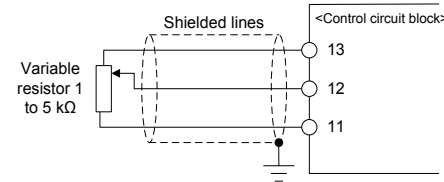
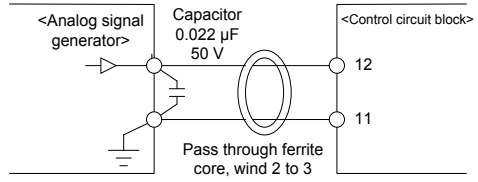
Table 2.2-30 Functional Description of Control Circuit Terminals (continued)

Classification	Terminal symbol	Terminal name	Functional description	
Analog output/pulse output	[FM]	Analog monitor FMV function FMI function	<p>This terminal outputs analog direct current voltage DC0 to 10 V or analog direct current DC4 to 20 mA / DC0 to 20mA monitor signal. The output form (FMV/FMI) can be switched using SW5 on the printed circuit board and function code F29. Refer to “Table 2.2-31 Functional Description of Slide switches”.</p> <p>The signal content can be chosen in the function code F31 data setting among the following items.</p> <ul style="list-style-type: none"> • Output frequency 1 (before slip compensation) • Output frequency 2 (after slip compensation) • Output current • Output voltage • Output torque • Load factor • Input power • PID feedback value • Actual speed/estimated speed • DC link bus voltage • Universal AO • Motor output • Calibration (+) • PID command (SV) • PID output (MV) • Position error in master-follower operation • Inverter heat sink temperature • PG feedback value • Customizable logic output signal 1 to 10 <p>* Allowable impedance for connection: Min 5 kΩ (at DC to 10 V output) (up to 2 analog volt meters (DC0 to 10 V, input impedance 10 kΩ) can be connected.)</p> <p>* Allowable impedance for connection: Max 500 Ω (at DC4 to 20 mA/DC0 to 20 mA)</p> <p>* Gain adjustable range: 0 to 300%</p>	
		Pulse monitor FMP function	<p>The terminal outputs pulse signal. Signal content can be chosen same as for the FMV function by function code F31 setting. The output form (FMP) can be switched using SW5 on the printed circuit board and function code F29. Refer to “Table 2.2-31 Functional Description of Slide switches”.</p> <p>* Allowable impedance for connection: Min. 5 kΩ (at DC to 10 V output) (up to 2 analog volt meters (DC0 to 10 V, input impedance 10 kΩ) can be connected.)</p> <p>* Pulse duty: Approximately 50%, pulse rate: 25 to 32000 p/s (at full scale)</p>	
			<p>• Pulse output waveform</p> 	<p>• FMP output circuit</p> 
	[FM2]	Analog monitor FMV2 function FMI2 function	<p>This terminal outputs analog direct current voltage DC0 to 10 V or analog direct current DC4 to 20 mA (DC0 to 20mA) monitor signal. The output form (FMV2/FMI2) can be switched using SW7 on the printed circuit board and function code F32. Refer to “Table 2.2-13 Functional Description of Slide switches”.</p> <p>The signal content can be chosen in the function code F35 data setting among the same items with [FM] (F31).</p> <ul style="list-style-type: none"> * This terminal is used on the models with the destination codes -GB/-C. * Allowable impedance for connection: Min 5 kΩ (at DC to 10 V output) (up to 2 analog volt meters (DC0 to 10 V, input impedance 10 kΩ) can be connected.) * Allowable impedance for connection: Max 500 Ω (at DC4 to 20 mA/DC0 to 20 mA) * Gain adjustable range: 0 to 300% 	
[11]	Analog output common terminal	<p>This terminal is the common terminal for analog input and analog/pulse output signals. The terminal is insulated from terminals [CM] and [CMY]. Do not use [CM] and [CMY] as common terminals for [FM], [FM2].</p>		

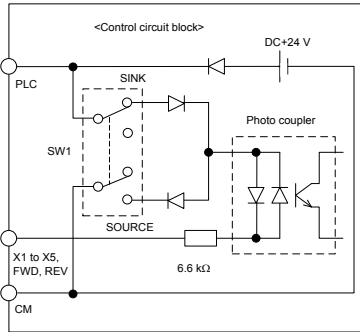
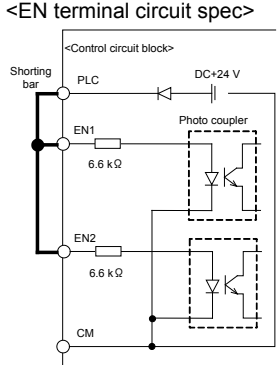
Table 2.2-30 Functional Description of Control Circuit Terminals (continued)

Classification	Terminal symbol	Terminal name	Functional description														
Transistor outputs	[Y1]	Transistor output 1	<p>(1) Various signals (running signal, frequency reached signal, overload forecast signal, etc) set up by function code E20, E21 can be output. For details, refer to Chapter 5 "FUNCTION CODE".</p> <p>(2) The operating mode of the transistor output terminals [Y1], [Y2] can be switched to "ON (active ON) at signal output" or "OFF (active OFF) at signal output".</p> <p><Transistor output circuit specification></p>  <table border="1" data-bbox="986 600 1361 792"> <thead> <tr> <th colspan="2">Item</th> <th>Maximum</th> </tr> </thead> <tbody> <tr> <td rowspan="2">Operating voltage</td> <td>ON level</td> <td>3 V</td> </tr> <tr> <td>OFF level</td> <td>27 V</td> </tr> <tr> <td colspan="2">Max load current at ON</td> <td>50 mA</td> </tr> <tr> <td colspan="2">Leak current at OFF</td> <td>0.1 mA</td> </tr> </tbody> </table> <p>Figure 2.2-18 Transistor Output Circuit</p> <p>Note</p> <ul style="list-style-type: none"> Connect a surge absorbing diode between the terminals the excitation coil when connecting control relays. When a power source is needed for the circuit to be connected, terminal PLC can be used as a power source terminal. Rated voltage: DC+24 V (power supply voltage fluctuation range: DC+22 to +27 V), maximum 50 mA). In this case, terminal [CMY] must be shorted to terminal [CM]. 	Item		Maximum	Operating voltage	ON level	3 V	OFF level	27 V	Max load current at ON		50 mA	Leak current at OFF		0.1 mA
	Item			Maximum													
	Operating voltage	ON level	3 V														
OFF level		27 V															
Max load current at ON		50 mA															
Leak current at OFF		0.1 mA															
[Y2]	Transistor output 2																
[CMY]	Transistor output common	This terminal is the common terminal for transistor output signals. This terminal is insulated from terminals [CM] and [11].															
	Tip	<p>■ When connecting the programmable controller to terminals [Y1], [Y2].</p> <p>The circuit configuration example for connecting the inverter transistor output to the programmable controller is shown in Figure 2.2-19. Circuit (a) in Figure 2.2-19 shows the programmable controller input circuit as sink input and circuit (b) shows as the source input case.</p>  <p>(a) Connection diagram for sink input type programmable controller</p> <p>(b) Connection diagram for source input type programmable controller</p> <p>Figure 2.2-19 Example of Connection Circuit Configuration with Programmable Controller</p>															
Contact output	[30A/B/C]	Integrated alarm output	<p>(1) When the inverter stops with an alarm, output is generated on the relay contact (1C). Contact rating: AC250 V 0.3 A $\cos\phi = 0.3$, DC48 V 0.5 A</p> <p>(2) Terminals can be switched to "Terminals [30A to 30C] shorted (excitation: active ON) at ON signal output" or "Terminals [30A to 30C] open (non-excitation: active OFF) at ON signal output"</p>														

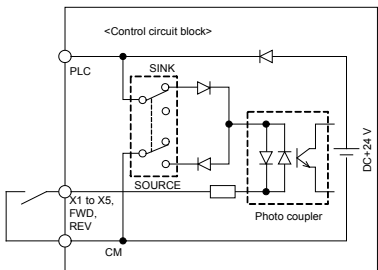
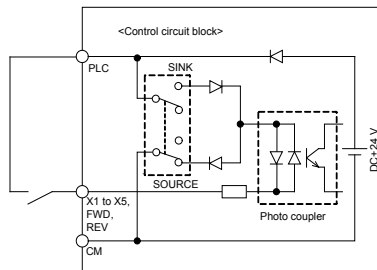
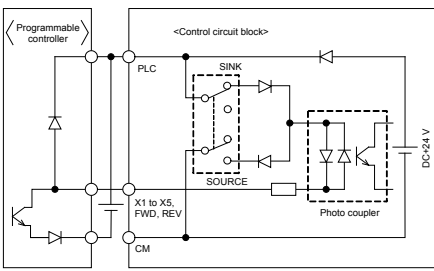
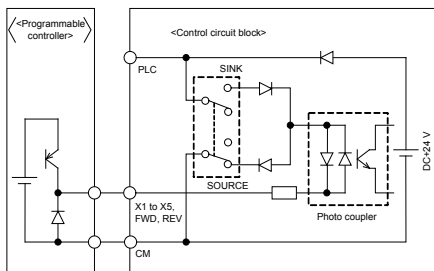
Table 2.2-30 Functional Description of Control Circuit Terminals (continued)

Classification	Terminal symbol	Terminal name	Functional description
Communication	RJ-45 connector for keypad connection	RJ-45 connector for keypad connection RS-485 communication port 1	<p>(1) Used to connect the keypad. The power to the keypad will be supplied from the inverter through this connector.</p> <p>(2) Also can be used to connect a computer, programmable controller, etc by RS-485 communication, after removing the keypad. (On terminating resistor, refer to “2.2.8 Operating slide switches”).</p>  <p style="text-align: center;">Figure 2.2-20 RJ-45 Connector Pin-layout</p> <ul style="list-style-type: none"> • Pins 1, 2, 7, and 8 are assigned as power supply source for the keypad. When connecting this RJ-45 connector to other devices, do not use these pins.
	RJ-45 connector for RS-485 /CANopen communication	RS-485 communication port 2 CANopen communication port	<p>(1) Can be used to connect a computer, programmable controller, etc by RS-485 communication. (On terminating resistor, refer to “2.2.8 Operating slide switches”).</p> <p>(2) Also can be used to connect a computer, programmable controller, etc by CANopen communication. (On terminating resistor, refer to “2.2.8 Operating slide switches”).</p>  <p style="text-align: center;">Figure 2.2-21 RJ-45 Connector Pin-layout</p> <ul style="list-style-type: none"> * This terminal is used on the models with the destination codes -GA. * SW6 is shared between RS-485 communications and CAN bus communications. If both communications are used at the same time and the necessity of the terminating resistor for each communication network is different (for example in the CAN bus is located at either end of the network, but in the RS-485 network is located in the middle), turn SW6 “OFF” and use an external terminating resistor where needed.

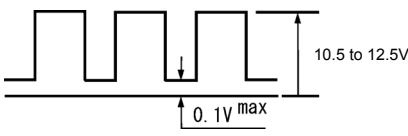
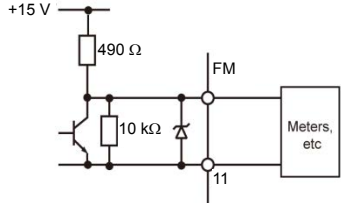
■ Wiring for control circuit terminals

For FRN0361E2■-4□ to FRN0590E2■-4□

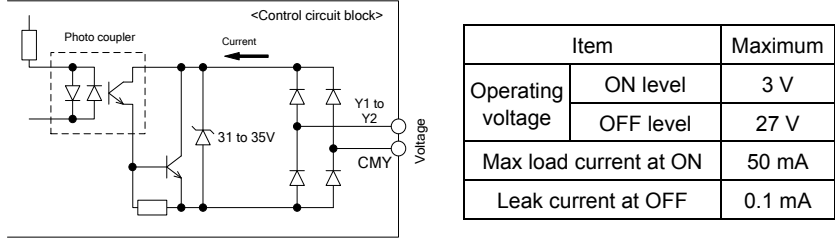
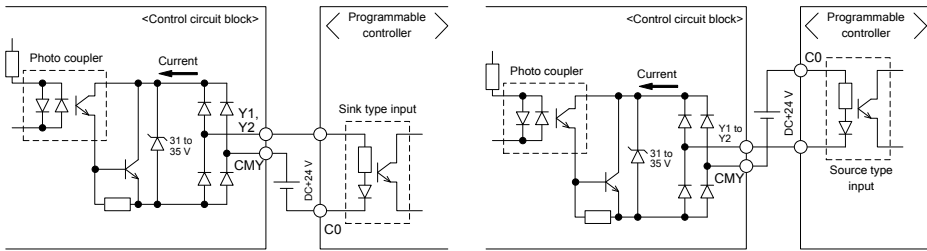
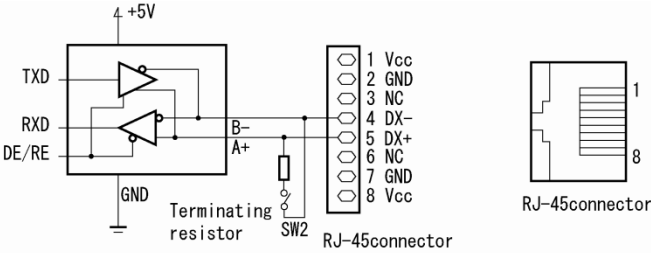
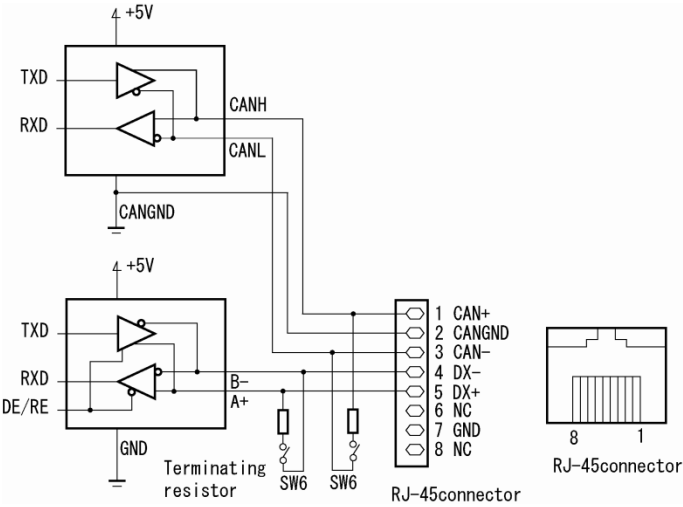
- (1) As shown in Figure 2.2-22, route the control circuit wires along the left side panel to the outside of the inverter.
- (2) Secure those wires to the wiring support, using a cable tie (e.g., Insulok) with 3.8 mm (0.15inch) or less in width and 1.5 mm (0.06inch) or less in thickness.

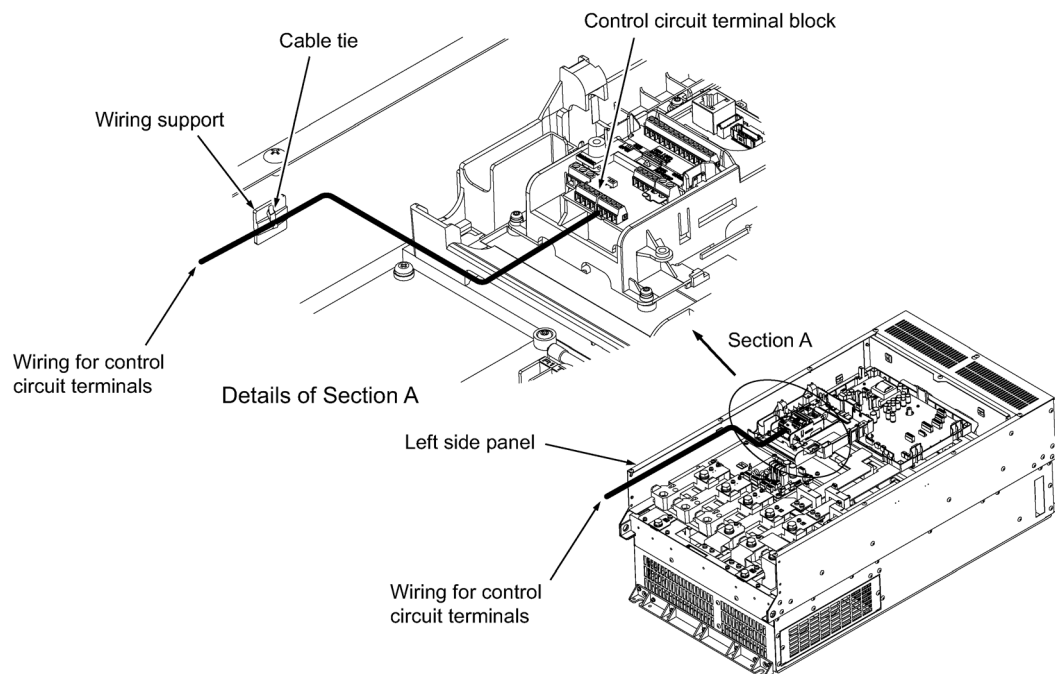

Figure 2.2-22 Wiring Route and Fixing Position for the Control Circuit Wires

- Note**
- Route the wiring of the control circuit terminals as far as possible from the wiring of the main circuit. Otherwise electric noise may cause malfunctions.
 - Fix the control circuit wires with a cable tie inside the inverter to keep them away from the live parts of the main circuit (such as the terminal block of the main circuit).

2.2.7 Switching connector (types FRN0203E2-4□ or above)

■ Position of each connector

The individual switching connectors are located on the power supply printed circuit board as shown in Figure 2.2-23.

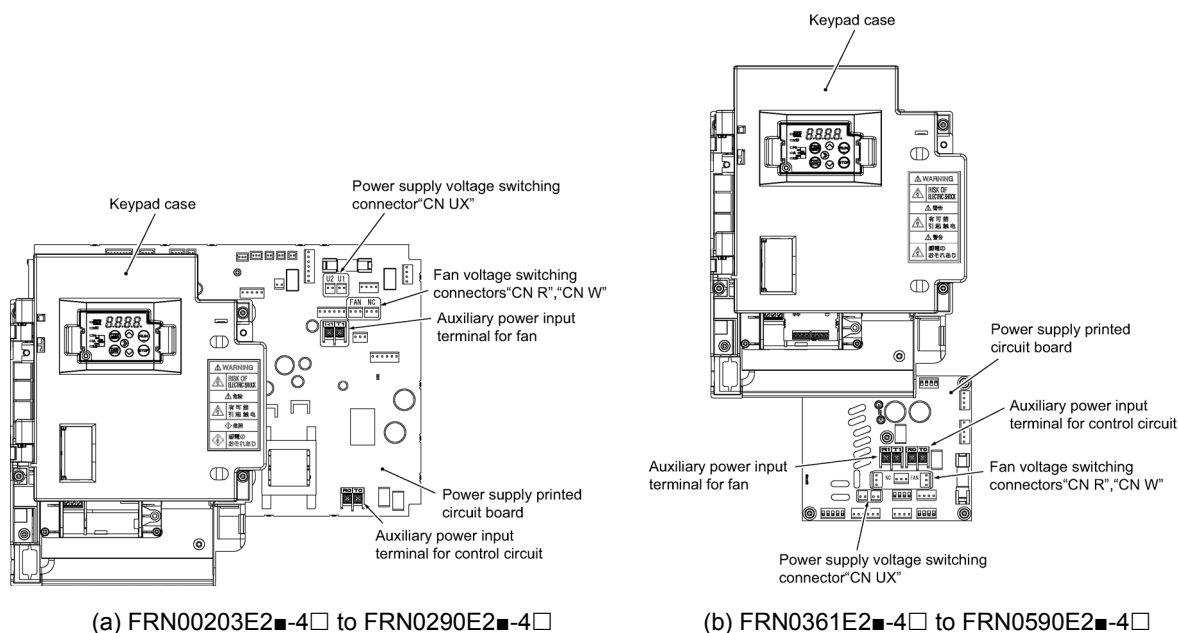
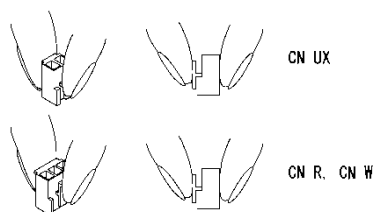

Figure 2.2-23 Switching Connector Positions



Note When removing the individual connectors, pinch the upper portion of the connector with the fingers, unlock the fastener, and pull. When inserting the connector, push in until the fastener lock engages with the receiving end with a click.

Figure 2.2-24 Attachment and Removal of the Switching Connector

■ Power supply switching connector “CN UX” (types FRN0203E2-4□ or above)

This power supply switching connector “CN UX” is equipped on FRN0203E2-4□ or above. Set the connector CN UX to U1 side (default) or U2 side depending on the power supply voltage specifications to be connected to the main power supply input terminals (L1/R, L2/S, L3/T) and/or the auxiliary power input terminals for the fan (R1, T1), according to the table below.

For details on the switching procedure, refer to “Figure 2.2-23 Switching Connector Positions” and “Figure 2.2-24 Attachment and Removal of the Switching Connector”.

(a) FRN0203E2-4□ to FRN0290E2-4□

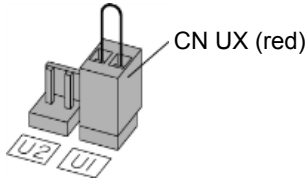
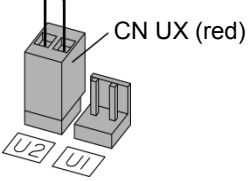
Setting		
Applicable voltage	398 to 440 V/ 50 Hz, 430 to 480 V/ 60 Hz (Factory default Model: -GA/-GB)	380 to 398V/ 50 Hz, 380 to 430 V/ 60 Hz (Factory default Model: -C)

(b) FRN0361E2-4□ to FRN0590E2-4□

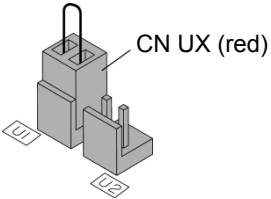
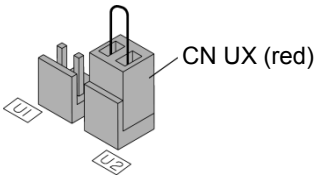
Setting		
Applicable voltage	398 to 440 V/ 50 Hz, 430 to 480 V/ 60 Hz (Factory default Model: -GA/-GB)	380 to 398V/ 50 Hz, 380 to 430 V/ 60 Hz (Factory default Model: -C)

■ Fan power source switching connector “CN R”, “CN W” (types FRN0203 E2-4□ or above)

FRENIC-Ace supports direct current power supply input with PWM converters in the standard specification. However, FRN0203 E2-4□ or above contains parts which are driven by AC power supply such as the AC fan, so AC power must also be supplied. When using DC power for the inverter, move connector “CN R” to **[NC]** side, move connector “CN W” to **[FAN]** side, and connect an AC power source to the auxiliary power input terminals for the fan (R1, T1).

For details on the switching procedure, refer to “Figure 2.2-23 Switching Connector Positions” and “Figure 2.2-24 Attachment and Removal of the Switching Connector”.

(a) FRN0203E2-4□ to FRN0290E2-4□

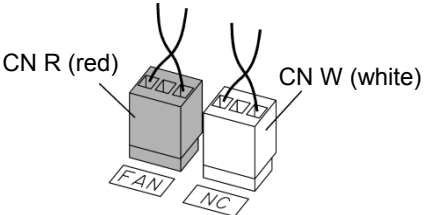
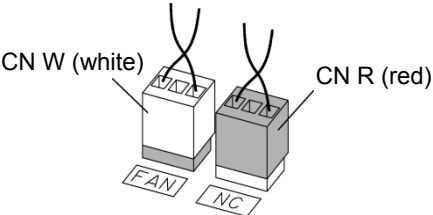
Setting		
Purpose	In the case terminals R1 and T1 are NOT used (Factory default)	In the case terminals R1 and T1 are used <ul style="list-style-type: none"> • DC bus input type • Combination with PWM converter

(b) FRN0361E2-4□ to FRN0590E2-4□

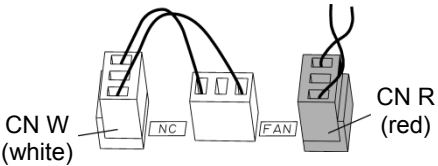
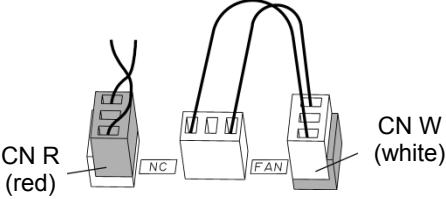
Setting		
Purpose	In the case terminals R1 and T1 are NOT used (Factory default)	In the case terminals R1 and T1 are used <ul style="list-style-type: none"> • DC bus input type • Combination with PWM converter

Note The fan power source switching connector “CN R” is on **[FAN]** and “CN W” is on **[NC]** when shipped from the factory. When direct current power supply input is not used, do not modify this setting. Mistakes in the fan power source switching connector setting may prevent the cooling fan from operating, and alarms such as cooling fan overheat **[OH]** and charging circuit error **[PLF]** may be generated.

2.2.8 Operating slide switches

⚠ WARNING ⚠

Operation of the slide switches should be conducted **after more than 5 minutes has elapsed** since power is shut off **for types FRN0115E2-2□ / FRN0072E2-4□ or below** and **after more than 10 minutes has elapsed for types FRN0085E2-4□ or above**. Confirm that the LED monitor and the charge lamp are turned off, and that the direct current intermediate circuit voltage between the main circuit terminals P(+)-N(-) is below the safe voltage (below DC+25 V) with a tester before operating the switches.

Risk of electric shock exists.

The I/O terminal specification can be changed, such as switching the analog output form, by operating the slide switches on the printed circuit board (Figure 2.2-25 The Slide Switch Locations on the Control Printed Circuit Board).

To operate the slide switches, remove the front cover and make the control printed circuit board visible. (For types FRN0085E2-4□ or above, also open the keypad case).

Refer to “2.2.2 Removal and attachment of the front cover/ terminal cover and wiring guide” to remove the front cover and to open/close the keypad case.

The switch locations on the control printed circuit board are shown in Figure 2.2-25 below.

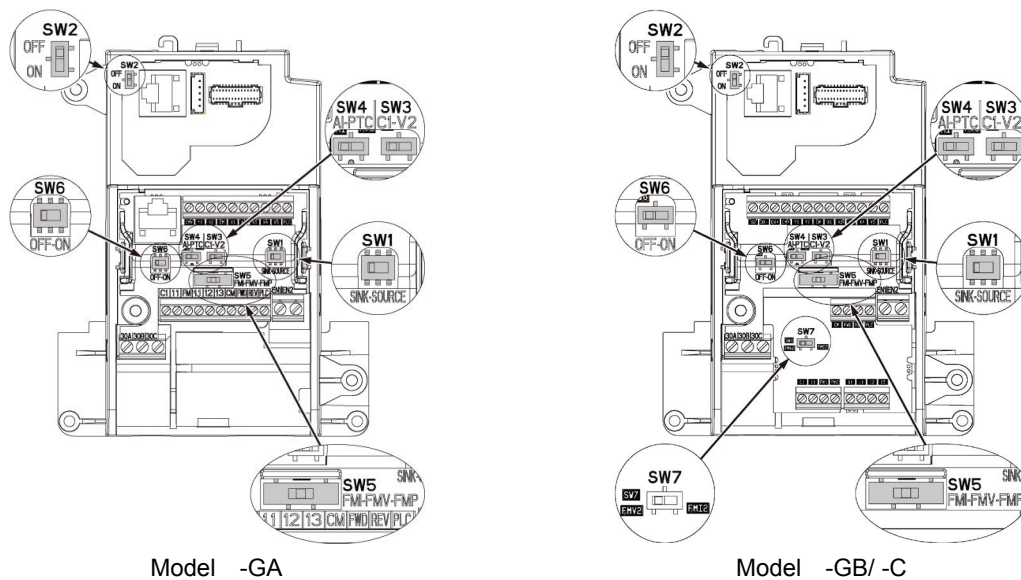

Figure 2.2-25 The Slide Switch Locations on the Control Printed Circuit Board

	SW1	SW2	SW3	SW4	SW5	SW6	SW7
Various	SINK SOURCE	OFF ON	C1 V2	AI PTC	FMV FMP	OFF ON	FMV2 FMV
Factory default -GA/-GB	SOURCE	OFF ON	C1	AI	FMV	OFF	FMV2
Factory default -C	SINK	OFF ON	C1	AI	FMV	OFF	FMV2

Note Use pointed devices (such as tweezers) to operate the switches. Avoid touching other electronic parts when moving the switches. The switch will be at open state when the slider is in the middle, so make sure to push the slider to the ends.

Functional description of the slide switches is explained in Table 2.2-31 Functional Description of Slide switches.

Table 2.2-31 Functional Description of Slide switches

Switch symbol	Functional description																							
SW1	<Switch to change sink/source setting of digital input terminals> <ul style="list-style-type: none"> This switch determines the type of input (sink or source) to use for digital input terminals [X1] to [X5], FWD, and REV. 																							
SW2	<Switch to change the RS-485 communication port 1 terminating resistor (RS-485 communication port (on the control PCB))> <ul style="list-style-type: none"> Move the switch to the ON side when RS-485 communication is used and the inverter is located at either end of the communication network. 																							
SW3 SW4	<Switch to change terminal [C1] input setting to current/voltage/PTC thermistor> This switch changes the input type for terminal [C1]. <table border="1" data-bbox="368 629 1385 808"> <thead> <tr> <th>Input type \</th> <th>SW3</th> <th>SW4</th> <th>E59</th> <th>H26</th> </tr> </thead> <tbody> <tr> <td>Current input (factory default)</td> <td>C1 side</td> <td>AI side</td> <td>0</td> <td>0</td> </tr> <tr> <td>Voltage input</td> <td>V2 side</td> <td>AI side</td> <td>1</td> <td>0</td> </tr> <tr> <td>PTC thermistor input</td> <td>C1 side</td> <td>PTC side</td> <td>0</td> <td>1</td> </tr> </tbody> </table>				Input type \	SW3	SW4	E59	H26	Current input (factory default)	C1 side	AI side	0	0	Voltage input	V2 side	AI side	1	0	PTC thermistor input	C1 side	PTC side	0	1
Input type \	SW3	SW4	E59	H26																				
Current input (factory default)	C1 side	AI side	0	0																				
Voltage input	V2 side	AI side	1	0																				
PTC thermistor input	C1 side	PTC side	0	1																				
SW5	<Switch to change terminal [FM] output setting to current/voltage/pulse> This switch changes the output type for terminal [FM]. When operating this switch, also change function code F29. <table border="1" data-bbox="368 927 1385 1106"> <thead> <tr> <th>Output type \</th> <th>SW5</th> <th>F29</th> </tr> </thead> <tbody> <tr> <td>Current output</td> <td>FMI side</td> <td>1 or 2</td> </tr> <tr> <td>Voltage output (factory default)</td> <td>FMV side</td> <td>0</td> </tr> <tr> <td>Pulse output</td> <td>FMP side</td> <td>3</td> </tr> </tbody> </table>				Output type \	SW5	F29	Current output	FMI side	1 or 2	Voltage output (factory default)	FMV side	0	Pulse output	FMP side	3								
Output type \	SW5	F29																						
Current output	FMI side	1 or 2																						
Voltage output (factory default)	FMV side	0																						
Pulse output	FMP side	3																						
SW6	<Switch to change the RS-485 communication port 2 terminating resistor (RS-485 communication port (on the terminal board))> <ul style="list-style-type: none"> Used for the RS-485/CANopen communication. Move the switch to the ON position when the inverter is located at either end of the communication network. 																							
SW7	<Switch to change terminal [FM2] output setting to voltage/current> The terminal is used only on the model with the destination code -C. This switch changes the output type for terminal [FM2]. When operating this switch, also change function code F32. <table border="1" data-bbox="368 1386 1385 1525"> <thead> <tr> <th>Output type \</th> <th>SW7</th> <th>F32</th> </tr> </thead> <tbody> <tr> <td>Voltage output</td> <td>FMV2 side</td> <td>0</td> </tr> <tr> <td>Current output</td> <td>FMI2 side</td> <td>1 or 2</td> </tr> </tbody> </table>				Output type \	SW7	F32	Voltage output	FMV2 side	0	Current output	FMI2 side	1 or 2											
Output type \	SW7	F32																						
Voltage output	FMV2 side	0																						
Current output	FMI2 side	1 or 2																						



Exercise caution as expected operation may not result if the setting above is not conducted accurately.

2.3 Attachment and Connection of Keypad

2.3.1 Parts required for connection

The following parts are necessary when attaching the keypad to locations other than the inverter main body.

Part name	Type	Remarks
Keypad extension cable (note 1)	CB-5S, CB-3S, CB-1S	Three lengths available (5 m, 3 m, 1 m) (3.3ft, 9.8ft, 16.4ft)
Keypad fixing screws	M3×□ (note 2)	2 screws required (prepared by user)

(Note 1) When using commercially available LAN cable, use 10BASE-T/100BASE-TX straight cables (below 20 meters) which meet the ANSI/TIA/EIA-568A category 5 standards of U.S.A.

Recommended LAN cable

Manufacturer: Sanwa Supply, Inc.

Type: KB-10T5-01K (for 1 meter)

KB-STP-01K (for 1 meter) (shielded cable when conforming to EMC directive)

(Note 2) When attaching to the cabinet, use a fixing screw of appropriate length to the cabinet thickness.

2.3.2 Attachment procedure

The keypad can be attached in the following forms.

- Attach to the inverter main body (refer to Figure 2.3-1 (a), (b), (c))
- Attach to the cabinet (refer to Figure 2.3-2)
- Operate the panel remotely, on the hand (refer to Figure 2.3-3)

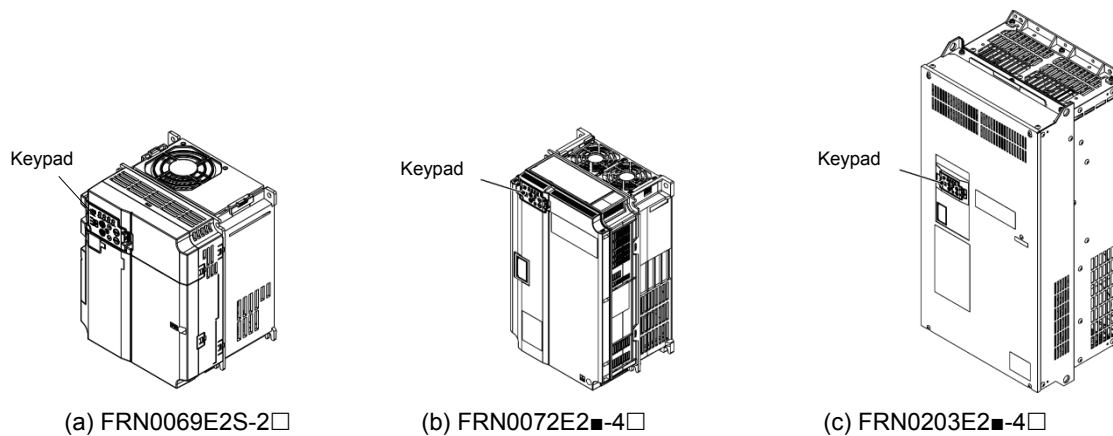

Figure 2.3-1 Attaching the Keypad to the Inverter Main Body

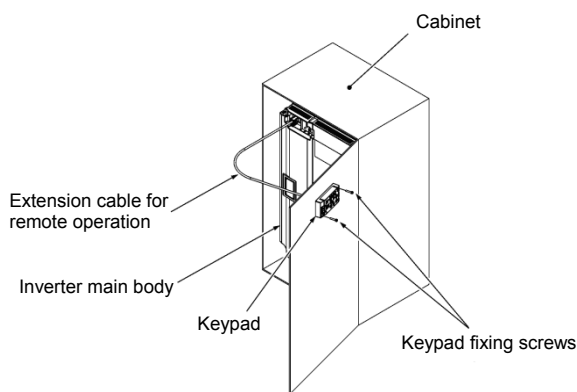

Figure 2.3-2 Attaching the Keypad on the Cabinet

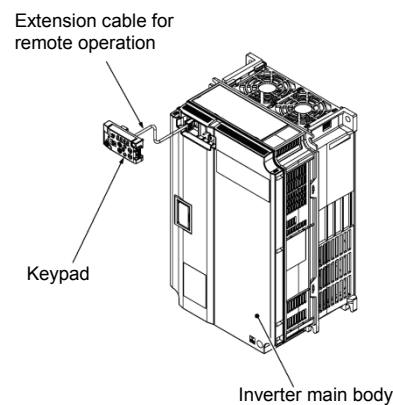

Figure 2.3-3 Operating the Keypad Remotely, on the Hand

■ Attachment to the cabinet

- (1) Squeeze the hooks at the arrows and pull as shown in Figure 2.3-4.

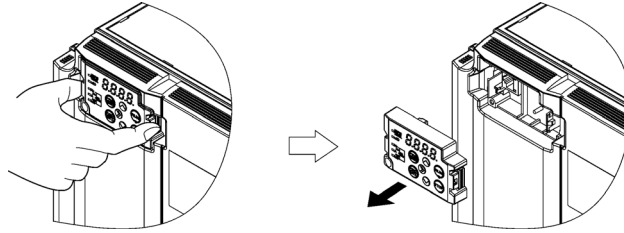

Figure 2.3-4 Removal of the Keypad

- (2) Attach the keypad rear cover to the keypad using the included keypad rear cover fixing screw.

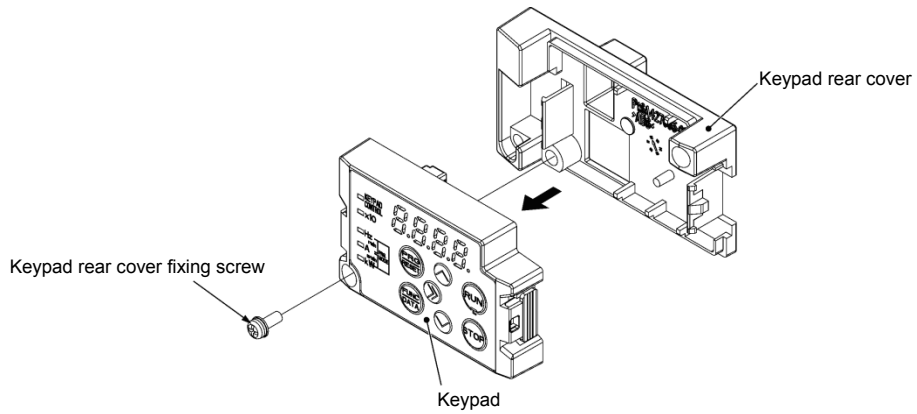

Figure 2.3-5 Attachment of the Keypad

(3) Cut the cabinet to attach the keypad, as shown in Figure 2.3-6.

(Units: mm [inch])

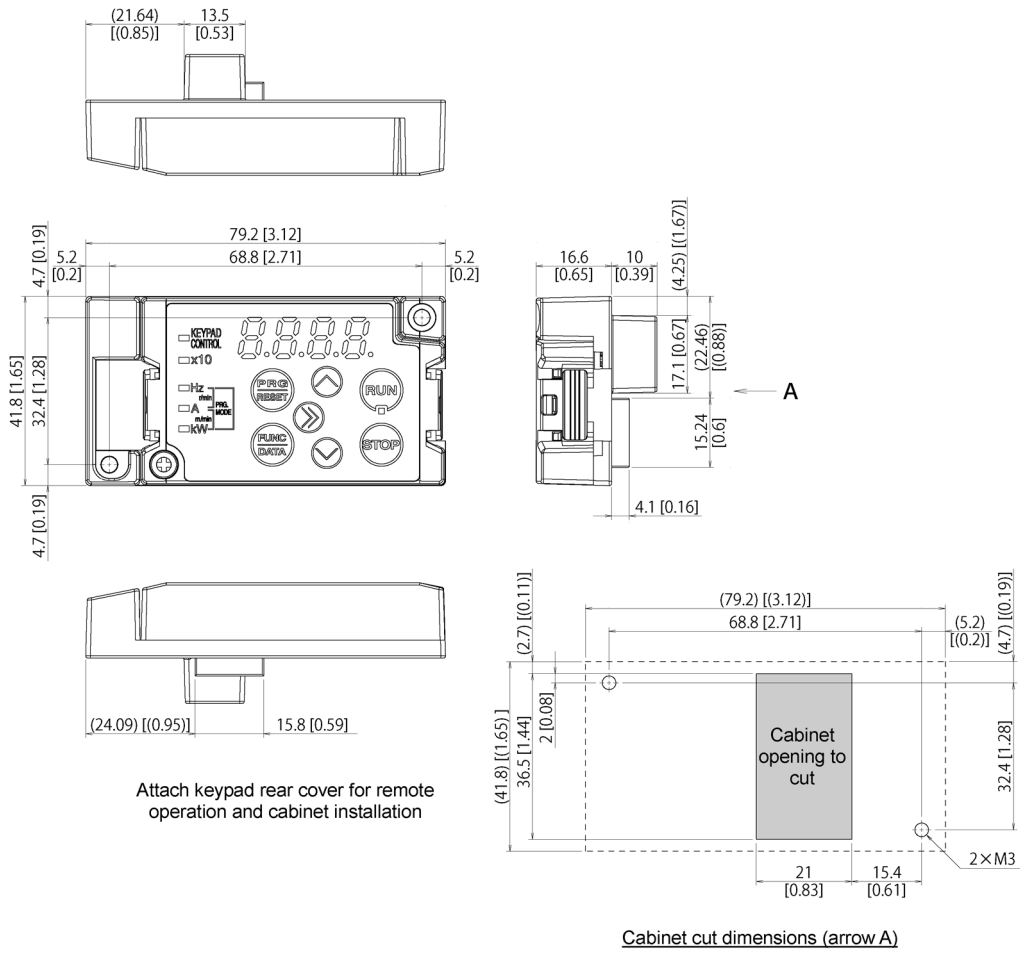

Figure 2.3-6 Fixing Screw Positions and the Dimensions of the Cabinet to Cut

- (4) Fix the keypad to the cabinet using 2 keypad rear cover fixing screws. (Refer to Figure 2.3-7) (tightening torque: 0.7 N•m(6.2lb-in))

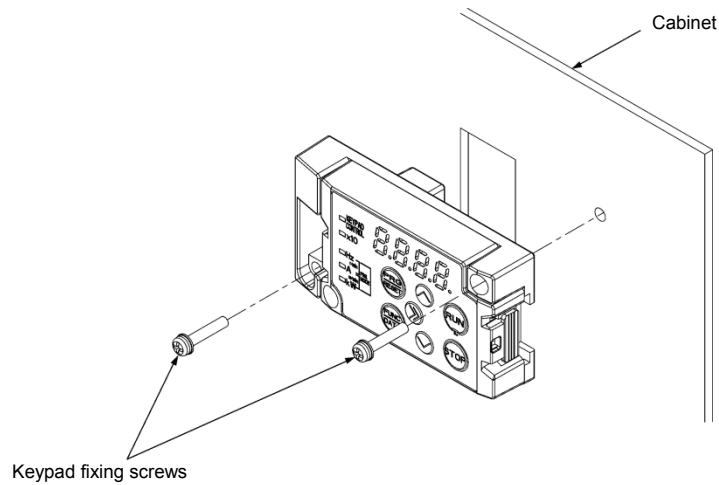

Figure 2.3-7 Attachment of the Keypad

- (5) Connect the extended cable for remote operation (CB-5S, CB-3S, CB-1S) or the commercially available LAN cable (straight) to the keypad RJ-45 connector and the inverter main body RJ-45 connector (modular jack). (Refer to Figure 2.3-8.)

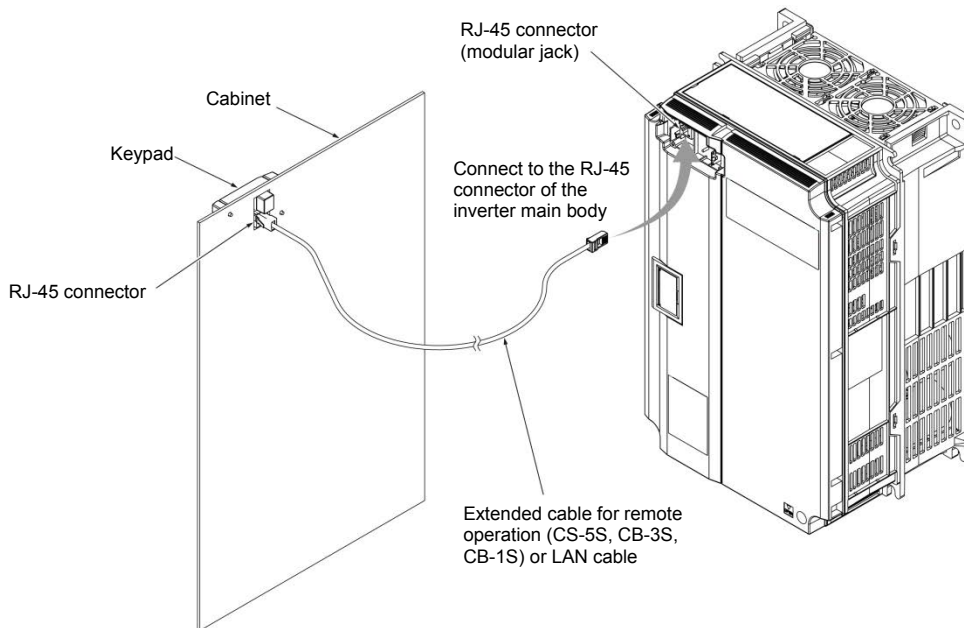

Figure 2.3-8 Connection of the Extension Cable or the Commercially Available LAN Cable between the Keypad and the Inverter Main Body

⚠ CAUTION

- Do not connect the inverter to PC LAN ports, Ethernet hubs, or telephone lines. The inverter and the connected instrument may be damaged.

Risk of fire and risk of accidents exist.

■ **Operating remotely, on the hand**

Connect following the procedure (5) in “■ Attachment to the cabinetAttachment to the cabinetAttachment to the cabinet”.

2.4 RJ-45 Cover

The opening for the RS-485 communication cable connection (RJ-45 connector) is located below the keypad, as shown in Figure 2.4-1 and Figure 2.4-2. There is not the RJ-45 connector in model GB and C.

■ Types FRN0069E2-2GA / FRN0044E2-4GA / FRN0011E2-7GA or below

To connect the RS-485 communication cable, open the RJ-45 cover as shown in Figure 2.4-1.

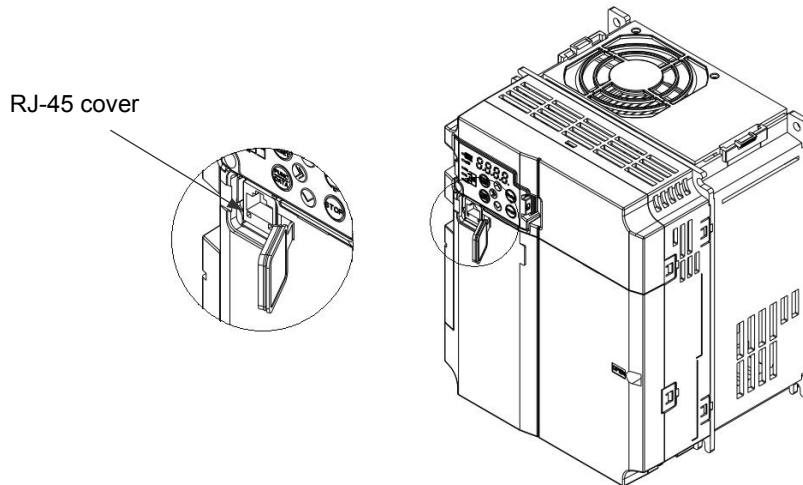

Figure 2.4-1 Connection of the RS-485 Communication Cable

■ Types FRN0088E2-2GA / FRN0059E2-4GA or above

To connect the RS-485 communication cable, open the RJ-45 cover until the “click” can be heard and connect the cable, as shown in Figure 2.4-2.

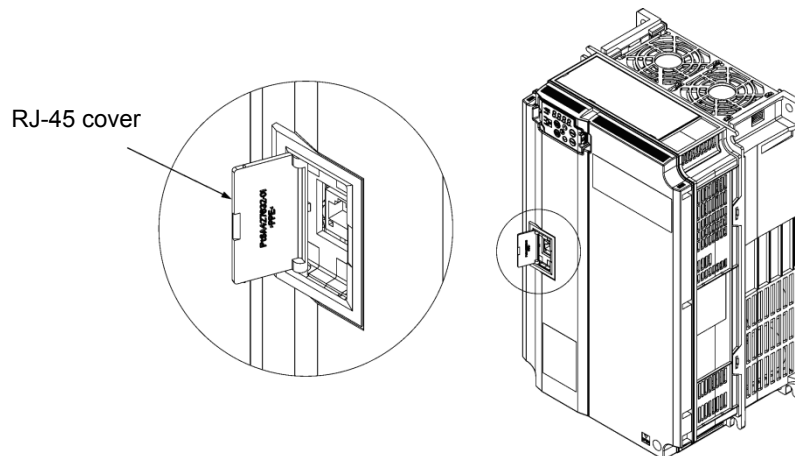

Figure 2.4-2 Connection of the RS-485 Communication Cable

Connect with the PC via the RS-485 converter using the RS-485 communication cable. The PC loader allows editing, confirmation, and management of the inverter function codes, and monitoring of operation data remotely. The operating status and alarms can also be monitored.

Chapter 3

OPERATION USING THE KEYPAD

This chapter describes keypad operation of the inverter.

Contents

3.1	Names and Functions of Keypad Components	3-1
3.2	Overview of Operation Modes	3-3
3.3	Running Mode	3-5
3.3.1	Monitoring the running status	3-5
3.3.2	Monitoring light alarms	3-7
3.3.3	Running or stopping the motor	3-8
3.3.4	Setting up reference frequency from the keypad	3-9
3.3.5	Setting up PID commands from the keypad	3-10
[1]	Settings under PID process control	3-10
[2]	Settings under PID dancer control	3-12
3.3.6	Jogging operation	3-14
3.3.7	Remote and local modes	3-15
3.4	Programming Mode	3-16
3.4.1	Setting up function codes "Data Setting: <i>1F_</i> through <i>1O_</i> "	3-17
3.4.2	Checking changed function codes "Data Checking: <i>2rEP</i> "	3-18
3.4.3	Monitoring the running status "Drive Monitoring: <i>3rPE</i> "	3-19
3.4.4	Checking I/O signal status "I/O Checking: <i>4, 1O</i> "	3-23
3.4.5	Reading maintenance information "Maintenance Information: <i>5LHE</i> "	3-27
3.4.6	Reading alarm information "Alarm Information: <i>6rAL</i> "	3-31
3.4.7	Copying data "Data Copying: <i>7rCPY</i> "	3-34
3.4.8	Setting up basic function codes quickly "Quick Setup: <i>0FrC</i> "	3-38
3.5	Alarm Mode	3-40
3.5.1	Releasing the alarm and switching to Running mode	3-40
3.5.2	Displaying the alarm history	3-40
3.5.3	Displaying the status of inverter at the time of alarm	3-40
3.5.4	Switching to Programming mode	3-40

3.1 Names and Functions of Keypad Components

The keypad allows you to run and stop the motor, display various data, configure function code data, and monitor I/O signal states, maintenance information and alarm information.

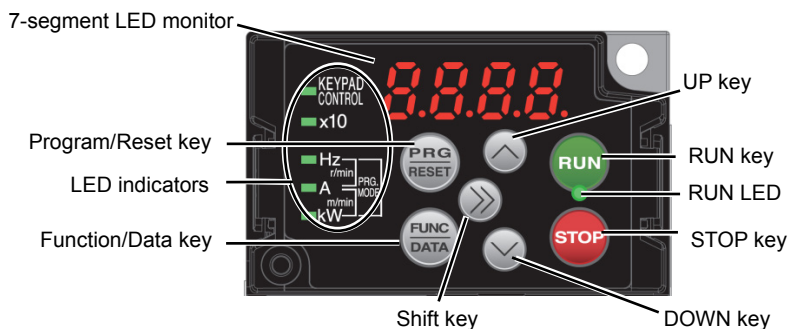





Table 3.1-1 Overview of Keypad Functions

Item	LED Monitor, Keys, and LED Indicators	Functions
LED Monitor		<p>Four-digit, 7-segment LED monitor which displays the followings according to the operation modes.</p> <ul style="list-style-type: none"> ■ In Running mode: Running status information (e.g., output frequency, current, and voltage) When a light alarm occurs, $L-FL$ is displayed. ■ In Programming mode: Menus, function codes and their data ■ In Alarm mode: Alarm code, which identifies the alarm factor that has activated the protective function.
Operation Keys		<p>Program/Reset key which switches the operation modes of the inverter.</p> <ul style="list-style-type: none"> ■ In Running mode: Pressing this key switches the inverter to Programming mode. ■ In Programming mode: Pressing this key switches the inverter to Running mode. ■ In Alarm mode: Pressing this key after removing the alarm factor resets the alarm and switches back to Running mode.
		<p>Function/Data key which switches the operations you want to do in each mode as follows:</p> <ul style="list-style-type: none"> ■ In Running mode: Pressing this key switches the information to be displayed concerning the status of the inverter (output frequency (Hz), output current (A), output voltage (V), etc.). When a light alarm is displayed, holding down this key resets the light alarm and switches back to Running mode. ■ In Programming mode: Pressing this key displays the function code or establishes the data entered with and keys. ■ In Alarm mode: Pressing this key displays the details of the problem indicated by the alarm code that has come up on the LED monitor.
		RUN key. Press this key to run the motor.
		STOP key. Press this key to stop the motor.
		UP and DOWN keys. Press these keys to select the setting items and change the function code data displayed on the LED monitor.
		Shift key. Press this key to shift the cursor to the right for entry of a numerical value.

Table 3.1-1 Overview of Keypad Functions (continued)

Item	LED Monitor, Keys, and LED Indicators	Functions
LED Indicators	RUN LED	Lights when running with a run command entered by the  key, by terminal command FWD or REV , or through the communications link.
	KEYPAD CONTROL LED	Lights when the inverter is ready to run with a run command entered by the  key (F02 = 0, 2, or 3). In Programming and Alarm modes, however, pressing the  key cannot run the inverter even if this indicator lights.
	Unit LEDs (3 LEDs)	These three LED indicators identify the unit of numeral displayed on the LED monitor in Running mode by combination of lit and unlit states of them. Unit: Hz, A, kW, r/min and m/min Refer to "3.3.1 Monitoring the running status" for details. While the inverter is in Programming mode, <input checked="" type="checkbox"/> Hz the LEDs of Hz and kW light. <input type="checkbox"/> A <input checked="" type="checkbox"/> kW
	x10 LED	Lights when the data to display exceeds 9999. When this LED lights, the "displayed value x 10" is the actual value. Example: If data is "12,345," the LED monitor displays <i>1234</i> and the x10 LED lights, meaning that "1,234 × 10 = 12,340."

■ LED monitor

In Running mode, the LED monitor displays running status information (output frequency, current or voltage); in Programming mode, it displays menus, function codes and their data; and in Alarm mode, it displays an alarm code which identifies the alarm factor that has activated the protective function.

If one of LED4 through LED1 is blinking, it means that the cursor is at this digit, allowing you to change it.

If the decimal point of LED1 is blinking, it means that the currently displayed data is a value of the PID command, not the frequency data usually displayed.

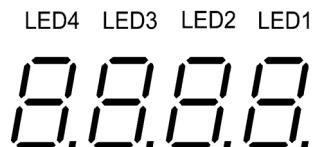

Figure 3.1-1 7-Segment LED Monitor

Table 3.1-2 Alphanumeric Characters on the LED Monitor

Character	7-segment	Character	7-segment	Character	7-segment	Character	7-segment
0	<i>0</i>	9	<i>9</i>	i	<i>,</i>	r	<i>r</i>
1	<i>1</i>	A	<i>A</i>	J	<i>J</i>	S	<i>S</i>
2	<i>2</i>	b	<i>b</i>	K	<i>K</i>	T	<i>T</i>
3	<i>3</i>	C	<i>C</i>	L	<i>L</i>	u	<i>u</i>
4	<i>4</i>	d	<i>d</i>	M	<i>M</i>	v	<i>v</i>
5	<i>5</i>	E	<i>E</i>	n	<i>n</i>	W	<i>W</i>
6	<i>6</i>	F	<i>F</i>	o	<i>o</i>	X	<i>X</i>
7	<i>7</i>	G	<i>G</i>	P	<i>P</i>	y	<i>y</i>
8	<i>8</i>	H	<i>H</i>	q	<i>q</i>	Z	<i>Z</i>
Special characters and symbols (numbers with decimal point, minus and underscore)							
0. - 9.	<i>0. - 9.</i>	-	<i>-</i>	_	<i>_</i>		

3.2 Overview of Operation Modes

The FRENIC-Ace features the following three operation modes.

Table 3.2-1 Operation Modes

Operation mode	Description
Running mode	When powered ON, the inverter automatically enters this mode. This mode allows you to specify the reference frequency, PID command value and etc., and run/stop the motor with the / keys. It is also possible to monitor the running status in real time. If a light alarm occurs, the $L-FL$ appears on the LED monitor.
Programming mode	This mode allows you to configure function code data and check a variety of information relating to the inverter status and maintenance.
Alarm mode	If an alarm condition arises, the inverter automatically enters Alarm mode in which you can view the corresponding alarm code* and its related information on the LED monitor. * Alarm code: Indicates the cause of the alarm condition. For details, first see “Table 6.1-1 Abnormal States Detectable (“Heavy Alarm” and “Light Alarm” Objects)” in Chapter 6 “6.1 Protective Function”, and then read the troubleshooting of each alarm.

Figure 3.2-1 shows the status transition of the inverter between these three operation modes.

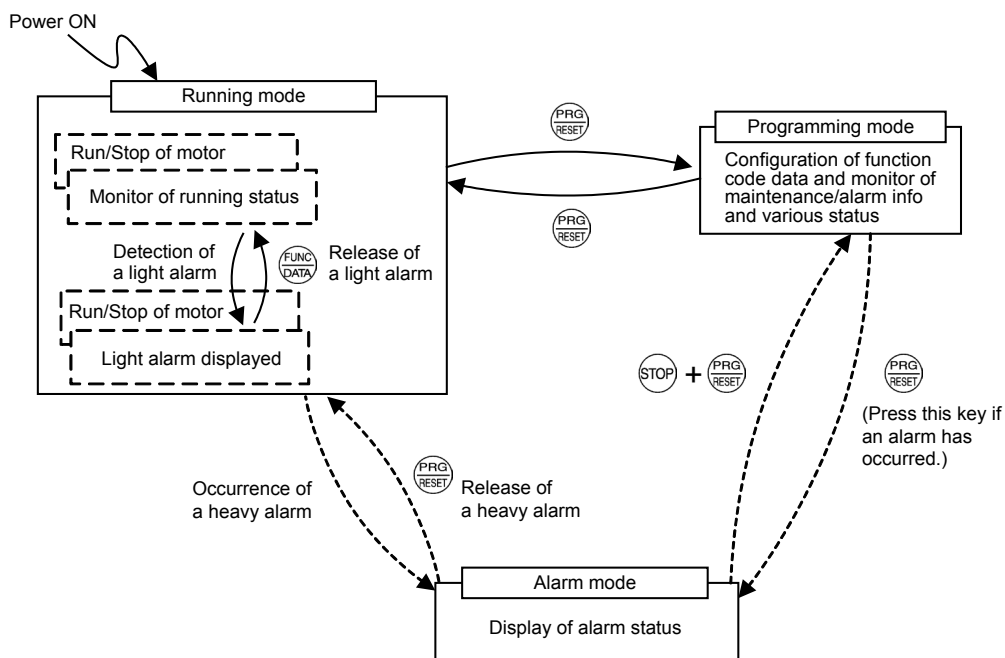

Figure 3.2-1 Status Transition between Operation Modes

Tip Simultaneous keying

Simultaneous keying means pressing two keys at the same time. The simultaneous keying operation is expressed by a “+” letter between the keys throughout this manual.

For example, the expression “ + keys” stands for pressing the key with the key held down.

Figure 3.2-2 illustrates the transition of the LED monitor screen during Running mode, the transition between menu items in Programming mode, and the transition between alarm codes at different occurrences in Alarm mode.

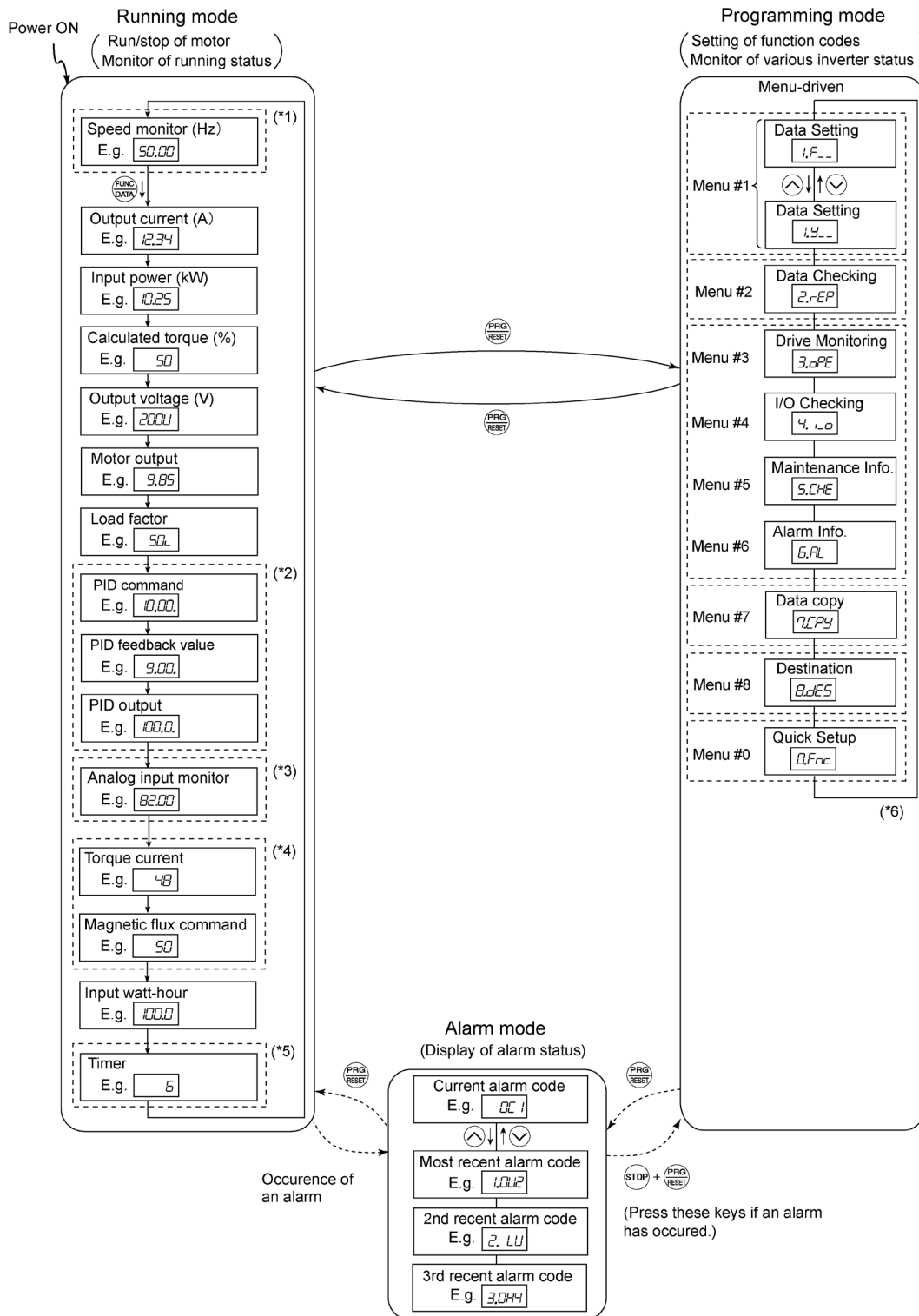

Figure 3.2-2 Transition between Basic Screens in Individual Operation Mode

- (*1) The speed monitor allows you to select the desired one from the speed monitor items by using function code E48.
- (*2) Applicable only when PID control is active (J01 = 1, 2 or 3).
- (*3) The analog input monitor can appear only when the analog input monitor function is assigned to one of the analog input terminals by one of function codes E61 to E63 (= 20).
- (*4) □ appears under the V/f control.
- (*5) The Timer screen appears only when the timer operation is enabled with function code C21 (C21 = 1).
- (*6) Applicable only when the full-menu mode is selected (E52 = 2). When a remote keypad with USB is equipped, 7.CPY is displayed.

3.3 Running Mode

3.3.1 Monitoring the running status

In Running mode, the 17 items listed below can be monitored. Immediately after the inverter is turned on, the monitor item specified by function code E43 is displayed. Press the  key to switch between monitor items.

Table 3.3-1 Monitoring Items

Monitor items	Display sample on the LED monitor *1	LED indicator ■: on, □: off	Unit	Meaning of displayed value	Function code data for E43
Speed monitor	Function code E48 specifies what to be displayed on the LED monitor and LED indicators.				0
Output frequency 1 (before slip compensation)	50.00	■Hz □A □kW	Hz	Frequency actually being output	(E48 = 0)
Output frequency 2 (after slip compensation)	50.00	■Hz □A □kW	Hz	Frequency actually being output	(E48 = 1)
Reference frequency	50.00	■Hz □A □kW	Hz	Reference frequency being set	(E48 = 2)
Motor speed	1500	■Hz ■A □kW	r/min	Output frequency (Hz) × $\frac{120}{P01}$	(E48 = 3)
Load shaft speed	300.0	■Hz ■A □kW	r/min	Output frequency (Hz) × E50	(E48 = 4)
Line speed	300.0	□Hz ■A ■kW	m/min	Output frequency (Hz) × E50	(E48 = 5)
Constant feeding rate time	50	□Hz □A □kW	min	$\frac{50}{\text{Output frequency (Hz)} \times E39}$	(E48 = 6)
Speed (%)	50.0	□Hz □A □kW	%	$\frac{\text{Output frequency}}{\text{Maximum frequency}} \times 100$	(E48 = 7)
Output current	12.34	□Hz ■A □kW	A	Current output from the inverter in RMS	3
Input power	10.25	□Hz □A ■kW	kW	Input power to the inverter	9
Calculated torque *2	50	□Hz □A □kW	%	Motor output torque (Calculated value)	8
Output voltage *3	200.0	□Hz □A □kW	V	Voltage output from the inverter in RMS	4
Motor output *4	9.85	□Hz □A ■kW	kW	Motor output (kW)	16
Load factor *5	50	□Hz □A □kW	%	Load factor of the motor in % as the rated output being at 100%	15
PID command *6, *7	10.00	□Hz □A □kW	—	PID command/feedback amount converted to a physical quantity of the object to be controlled (e.g. temperature)	10
PID feedback amount *6, *8	9.00	□Hz □A □kW	—	Refer to function codes J106 and J107 for details.	12
PID output *6, *7	100.0	□Hz □A □kW	%	PID output in % as the maximum frequency (F03) being at 100%	14
Analog input monitor *9	82.00	□Hz □A □kW	—	An analog input to the inverter in a format suitable for a desired scale. Refer to the following function codes. Terminal [12]: C59, C60 Terminal [C1] (C1 function): C65, C66 Terminal [C1] (V2 function): C71, C72	17
Current position pulse	765 4321	□Hz □A □kW	Pulse	Upper and lower digits are displayed alternately.	21
Positioning deviation pulse	765 4321	□Hz □A □kW	Pulse	Upper and lower digits are displayed alternately.	22
Torque current *10	48	□Hz □A □kW	%	Torque current command value or calculated torque current	23
Magnetic flux command *10	50	□Hz □A □kW	%	Magnetic flux command value	24
Input watt-hour	100.0	□Hz □A □kW	kWh	$\frac{\text{Input watt-hour (kWh)}}{100}$	25
Timer *11	50	□Hz □A □kW	s	Remaining time for timer operation	13

- *1 A value exceeding 9999 cannot be displayed as is on the 4-digit LED monitor screen, so the LED monitor displays one-tenth of the actual value with the x10 LED lit.
- *2 Calculated torque 100% is equal to the motor rated torque. For the calculation formula of the motor rated torque, refer to E.2 "Calculated formula" (1) in Appendix E "Conversion from SI Units."
- *3 When the LED monitor displays the output voltage, the 7-segment letter V in the lowest digit stands for the unit of the voltage "V."
- *4 When the LED monitor displays the motor output, the unit LED indicator "kW" blinks.
- *5 When the LED monitor displays the load factor, the 7-segment letter $\%$ in the lowest digit stands for "%."
- *6 These PID related items appear only under the PID control specified by function code J01 (= 1, 2 or 3).
- *7 When the LED monitor displays a PID command or its output amount, the dot (decimal point) attached to the lowest digit of the 7-segment letter blinks.
- *8 When the LED monitor displays a PID feedback amount, the dot (decimal point) attached to the lowest digit of the 7-segment letter lights.
- *9 The analog input monitor appears only when the analog input monitor function is assigned to one of the analog input terminals by one of function codes E61 to E63 (= 20). Specify the unit with C58, C64 and C70. When the displayed value is less than -999, the x10 LED is lit.
- *10 V/f appears under the V/f control.
- *11 The Timer screen appears only when the timed operation is enabled with function code C21 (C21 = 1).



The monitoring signals for the monitor items such as output frequency and output current can be filtered with function code E42 (LED display filter). Increase the E42 data if the monitored values are unstable and unreadable due to fluctuation of load.

( Function code E42)

3.3.2 Monitoring light alarms

The FRENIC-Ace identifies abnormal states in two categories--Heavy alarm and Light alarm. If the former occurs, the inverter immediately trips; if the latter occurs, the inverter shows the $L-AL$ on the LED monitor and blinks the KEYPAD CONTROL LED but it continues to run without tripping.

Which abnormal states are categorized as a light alarm ("Light alarm" object) should be defined with function codes H81 and H82 beforehand.

Assigning the **L-ALM** signal to any one of the digital output terminals with any of function codes E20, E21 and E27 (= 98) enables the inverter to output the **L-ALM** signal on that terminal upon occurrence of a light alarm.

 For details of the light alarm objects, refer to Chapter 6 "TROUBLESHOOTING."



■ How to check a light alarm factor

If a light alarm occurs, $L-AL$ appears on the LED monitor. To check the current light alarm factor, enter Programming mode by pressing the  key and select S_{36} on Menu #5 "Maintenance Information."

It is also possible to check the factors of the last three light alarms S_{37} (last) to S_{39} (3rd last). To check the light alarm factors in Menu #5 "Reading maintenance information," it is necessary to set the data of function code E52 to "2" (Full-menu mode) beforehand.



For details of the menu transition of the maintenance information, refer to "3.4.5 Reading maintenance information "Maintenance Information: S_{LHE} ."

■ How to reset a light alarm

After checking the current light alarm factor, to switch the LED monitor from the $L-AL$ indication state back to the running status display (e.g., output frequency), press the  key in Running mode.

If the light alarm factor has been removed, the KEYPAD CONTROL LED stops blinking and the **L-ALM** signal turns OFF. If not (e.g. DC fan lock), the KEYPAD CONTROL LED continues blinking and the **L-ALM** signal remains ON.

3.3.3 Running or stopping the motor

By factory default, pressing the  key starts running the motor in the forward direction and pressing the  key decelerates the motor to stop. The  key is enabled only in Running mode.

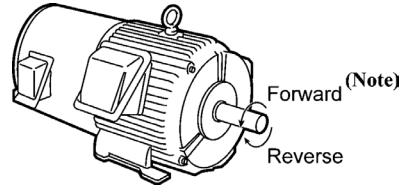

When the inverter is running, the RUN LED lights.

To run the motor in the reverse direction or to run it reversibly, change the data of function code F02 to “3” or “0,” respectively.



Note: The rotation direction of IEC-compliant motors is opposite to the one shown above.

Table 3.3-2 Motor Rotation Direction Specified by F02

Data for F02	Pressing the  key runs the motor:
0	In the direction commanded by terminal [FWD] or [REV]
1	Disable  key (The motor is driven by terminal [FWD] or [REV] command.)
2	In the forward direction
3	In the reverse direction

3.3.4 Setting up reference frequency from the keypad

You can set up the desired reference frequency with the \uparrow and \downarrow keys on the keypad. It is also possible to set up the reference frequency as load shaft speed, motor speed or speed (%) by setting function code E48.

Using the keypad (F01 = 0 (factory default) or 8)

- (1) Set function code F01 to "0" (Keypad operation using \uparrow / \downarrow keys) or "8" (Keypad operation using \uparrow / \downarrow keys, balanceless-bumpless). Frequency setting with the keypad is disabled in Programming or Alarm mode. To enable it, switch to Running mode.
- (2) Press the \uparrow / \downarrow key to display the current reference frequency. The lowest digit blinks.
- (3) To change the reference frequency, press the \uparrow / \downarrow key again. The new setting can be saved into the inverter's internal memory.

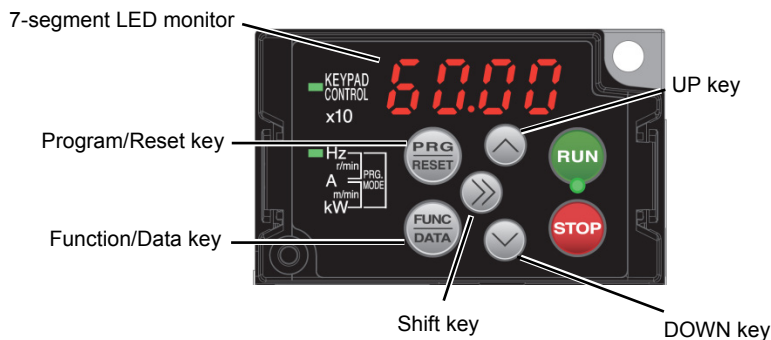

- Holding down the \uparrow / \downarrow key changes data in the least significant digit and generates a carry.
- The reference frequency can be saved either automatically by turning the main power OFF or only by pressing the FUNC DATA key. You can choose either way using function code E64. The factory default is "0" (Automatic saving when main power is turned OFF).
- To set the reference frequency, first press the \rightarrow key once to blink the least significant digit. After that, each time the \rightarrow key is pressed, the cursor moves to the next higher digit where data can be changed. This cursor movement allows you to easily move the cursor to the desired digit and change the data in higher digits.
- If you have set function code F01 to "0" or "8" but have selected a frequency setting 1 other than frequency command 1 (i.e., frequency command 2, frequency command via communication, or multistep frequency command), then the \uparrow and \downarrow keys are disabled to change the current reference frequency command even in Running mode. Pressing either of these keys just displays the current reference frequency.
- Setting F01 data to "8" (Keypad operation using \uparrow / \downarrow keys, balanceless-bumpless) enables balanceless-bumpless switching.

Balanceless-bumpless switching refers to the function that makes the inverter inherit the current frequency that has applied before the frequency command source is switched to the keypad from any other source, providing smooth switching and shockless running.

3.3.5 Setting up PID commands from the keypad

You can set up the desired PID commands with the \triangleleft and \triangleright keys on the keypad.

[1] Settings under PID process control

To enable the PID process control, you need to set the J01 data to "1" or "2."

Under the PID control, the items that can be specified or checked with \triangleleft and \triangleright keys are different from those under regular frequency control, depending upon the current LED monitor setting. If the LED monitor is set to the speed monitor (E43 = 0), the item accessible is a manual speed command (reference frequency); if it is set to any other, the item is a PID process command.

Setting the PID process command with \triangleleft and \triangleright keys

- (1) Set function code J02 to "0" (\triangleleft / \triangleright keys on keypad).
- (2) Set the LED monitor to something other than the speed monitor (E43=0) when the inverter is in Running mode. When the keypad is in Programming or Alarm mode, you cannot modify the PID process command with the \triangleleft / \triangleright key. To enable the PID process command to be modified with the \triangleleft / \triangleright key, first switch to Running mode.
- (3) Press the \triangleleft / \triangleright key to display the PID process command. The lowest digit and its decimal point blink on the LED monitor.
- (4) To change the PID process command, press the \triangleleft / \triangleright key again. The new setting can be saved into the inverter's internal memory.



- The PID process command can be saved either automatically by turning the main power OFF or only by pressing the FUNC/DATA key. You can choose either way using function code E64.
- Even if multistage frequency is selected as a PID command (**PID-SS1** or **PID-SS2** = ON), it is possible to set a PID command using the keypad.
- When function code J02 is set to any value other than "0," pressing the \triangleleft / \triangleright key displays, on the LED monitor, the PID command currently selected, but does not allow any change.
- On the LED monitor, the decimal point of the lowest digit is used to discriminate the PID related data from the reference command. The decimal point blinks or lights when a PID command or PID feedback amount is displayed, respectively.

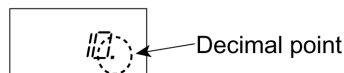

Table 3.3-3 PID Process Command Manually Set with \triangleleft / \triangleright Key and Requirements

PID control (Mode selection) J01	PID control (Remote command SV) J02	LED monitor E43	PID control multistage command PID-SS1, PID-SS2	With \triangleleft / \triangleright key
1 or 2	0	Other than 0	ON or OFF	PID process command <u>by keypad</u>
	Other than 0			PID process command <u>currently selected</u>

Setting up the reference frequency with \wedge and \vee keys under PID process control

When function code F01 is set to "0" (\wedge / \vee keys on keypad) and frequency setting 1 is selected as a manual speed command (when disabling the frequency setting command via communications link, multistep frequency command, and PID control), switching the LED monitor to the speed monitor in Running mode enables you to modify the reference frequency with the \wedge / \vee keys.

In Programming or Alarm mode, the \wedge / \vee keys are disabled to modify the reference frequency. You need to switch to Running mode.

Table 3.3-4 lists the combinations of the commands. Figure 3.3-1 illustrates how the manual speed command ① entered via the keypad is translated to the final frequency command ②.

The setting procedure is the same as that for setting of a usual reference frequency.

Table 3.3-4 Manual Speed (Frequency) Command Specified with \wedge / \vee Keys and Requirements

PID control (Mode selection) J01	LED monitor E43	Frequency setting 1 F01	Multistep frequency SS2	Multistep frequency SS1	Select link operation LE	Cancel PID control Hz/PID	Pressing \wedge / \vee keys controls:
1 or 2	0	0	OFF	OFF	OFF	ON (PID disabled)	Manual speed command (frequency) set by keypad
		Other than the above					Manual speed command (frequency) currently selected
		Don't care				OFF (PID enabled)	PID output (as final frequency command)

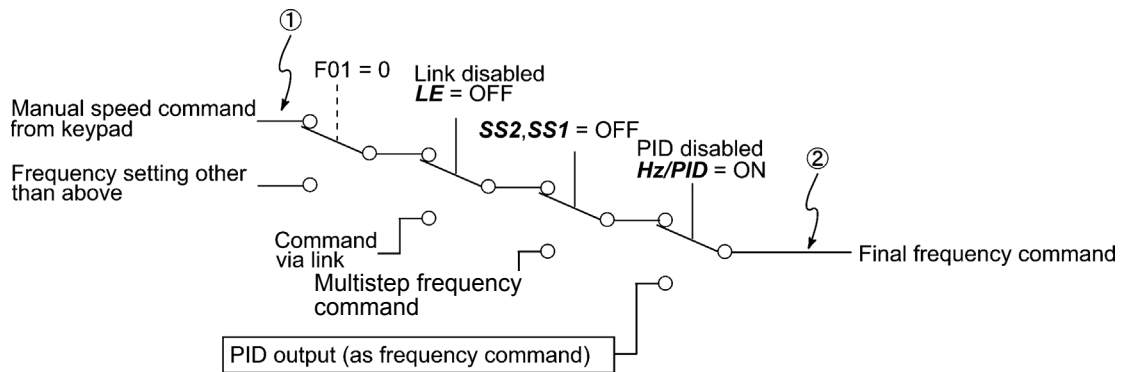

Figure 3.3-1

[2] Settings under PID dancer control

To enable the PID dancer control, you need to set the J01 data to “3.”

Under the PID control, the items that can be specified or checked with \uparrow and \downarrow keys are different from those under the regular frequency control, depending upon the current LED monitor setting. If the LED monitor is set to the speed monitor (E43 = 0), the item accessible is the primary frequency command; if it is set to any other, the item is the PID dancer position set point.

Setting the PID dancer position set point with the \uparrow and \downarrow keys

- (1) Set the J02 data to “0” (\uparrow / \downarrow keys on keypad).
- (2) Set the LED monitor to something other than the speed monitor (E43=0) when the inverter is in Running mode. When the keypad is in Programming or Alarm mode, you cannot modify the PID dancer position set point with the \uparrow / \downarrow key. To enable the PID dancer position set point to be modified with the \uparrow / \downarrow key, first switch to Running mode.
- (3) Press the \uparrow / \downarrow key to display the PID dancer position set point. The lowest digit and its decimal point blink on the LED monitor.
- (4) To change the PID dancer position set point, press the \uparrow / \downarrow key again. The command you have specified will be automatically saved into the inverter’s internal memory as function code J57 data. It is retained even if you temporarily switch to another PID command source and then go back to the via-keypad PID command. Furthermore, you can directly configure the command with function code J57.

- Tip**
- Even if multistep frequency is selected as a PID command (**PID-SS1** or **PID-SS2** = ON), it is possible to set a PID command using the keypad.
 - When function code J02 is set to any value other than “0,” pressing the \uparrow / \downarrow key displays, on the LED monitor, the PID command currently selected, but does not allow any change.
 - On the LED monitor, the decimal point of the lowest digit is used to discriminate the PID related data from the reference command. The decimal point blinks or lights when a PID command or PID feedback amount is displayed, respectively.

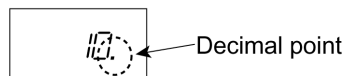

Table 3.3-5 PID Command Manually Set with \uparrow / \downarrow Key and Requirements

PID control (Mode selection) J01	PID control (Remote command SV) J02	LED monitor E43	PID control multistage command PID-SS1, PID-SS2	With \uparrow / \downarrow key
3	0	Other than 0	ON or OFF	PID command <u>by keypad</u>
	Other than 0			PID command <u>currently selected</u>

Setting up the primary frequency command with \wedge and \vee keys under PID dancer control

When function code F01 is set to "0" (\wedge / \vee keys on keypad) and frequency setting 1 is selected as a primary frequency command (when disabling the frequency setting command via communications link, multistep frequency command, and PID control), switching the LED monitor to the speed monitor in Running mode enables you to modify the primary frequency command with the \wedge / \vee keys.

In Programming or Alarm mode, the \wedge / \vee keys are disabled to modify the primary frequency command. You need to switch to Running mode.

Table 3.3-6 lists the combinations of the commands. Figure 3.3-2 illustrates how the primary frequency command ① entered via the keypad is translated to the final frequency command ②.

The setting procedure is the same as that for setting of a usual reference frequency.

Table 3.3-6 Primary Command (Frequency) Specified with \wedge / \vee Keys and Requirements

PID control (Mode selection) J01	LED monitor E43	Frequency setting 1 F01	Multistep frequency SS2	Multistep frequency SS1	Select link operation LE	Cancel PID control Hz/PID	Pressing \wedge / \vee keys controls:
3	0	0	OFF	OFF	OFF	ON (PID disabled)	Primary command (frequency) set by keypad
		Other than the above					OFF (PID enabled)
		Don't care				PID output (as final frequency command)	

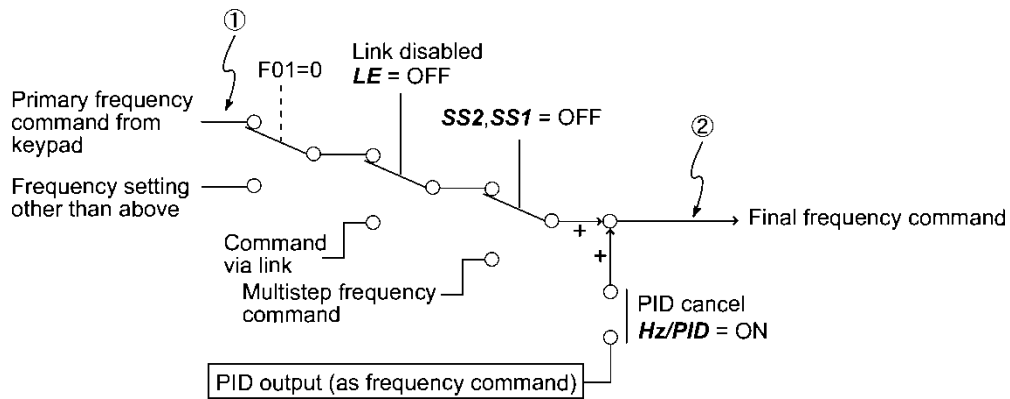

Figure 3.3-2

3.3.6 Jogging operation

This section provides the procedure for jogging the motor.

- (1) Make the inverter ready to jog by following the steps below. The LED monitor should display \overline{JOG} .

Enter Running mode (see “3.2 Overview of Operation Modes” on page 3-3) and press the STOP + RUN keys simultaneously.

The LED monitor displays the jogging frequency for approximately one second and then displays \overline{JOG} again.



- Function codes C20, H54 and H55 specify the jogging frequency and acceleration/deceleration time, respectively. Use these function codes exclusively for the jogging operation with your needs.
- Alternatively, using the input terminal command **JOG** (“Ready for jogging”) switches between the normal operation state and ready-to-jog state.
- Switching between the normal operation state and read-to-jog state with the STOP + RUN keys is possible only when the inverter is stopped.

- (2) Jogging the motor.

Hold down the RUN key during which the motor continues jogging. To decelerate to stop the motor, release the key.

- (3) Exiting the ready-to-jog state and returning to the normal operation state.

Press the STOP + RUN keys simultaneously.



For details, refer to the descriptions of function codes E01 to E05 in Chapter 5 “5.2.2 Function codes table.”

3.3.7 Remote and local modes

The inverter is available in either remote or local mode. In the remote mode that applies to ordinary operation, the inverter is driven under the control of the data settings stored in the inverter, whereas in the local mode that applies to maintenance operation, it is separated from the control system and is driven manually under the control of the keypad.

- Remote mode: Run and frequency commands are selected by function codes or source switching signals except **LOC** ("Select local (keypad) command").
- Local mode: The command source is the keypad, regardless of the settings specified by function codes. The keypad takes precedence over the settings specified by communications link operation signals.

Run commands from the keypad in local mode

The table below shows the input procedures of run commands from the keypad in the local mode.

Data for F02	Input Procedures of Run Commands from Keypad
0: Enable (RUN) / (STOP) keys on keypad (Motor rotation direction from digital terminals [FWD]/[REV])	Pressing the (RUN) key runs the motor in the direction specified by command FWD or REV assigned to terminal [FWD] or [REV], respectively. Pressing the (STOP) key stops the motor.
1: Enable terminal command FWD/REV	Pressing the (RUN) key runs the motor in the forward direction only. Pressing the (STOP) key stops the motor.
2: Enable (RUN) / (STOP) keys on keypad (Forward)	No specification of the motor rotation direction is required.
3: Enable (RUN) / (STOP) keys on keypad (Reverse)	Pressing the (RUN) key runs the motor in the reverse direction only. Pressing the (STOP) key stops the motor. No specification of the motor rotation direction is required.

Switching between remote and local modes

The remote and local modes can be switched by a digital input signal provided from the outside of the inverter. To enable the switching, you need to assign **LOC** as a digital input signal to any of terminals [X1] to [X5] by setting "35" to any of E01 to E05, E98 and E99.

Switching from remote to local mode automatically inherits the frequency settings used in remote mode. If the motor is running at the time of the switching from remote to local, the run command will be automatically turned ON so that all the necessary data settings will be carried over. If, however, there is a discrepancy between the settings used in remote mode and ones made on the keypad (e.g., switching from the reverse rotation in remote mode to the forward rotation only in local mode), the inverter automatically stops.

The transition paths between remote and local modes depend on the current mode and the value (ON/OFF) of **LOC**, as shown in the status transition diagram given Figure 3.3-3. Also, refer to above table for details

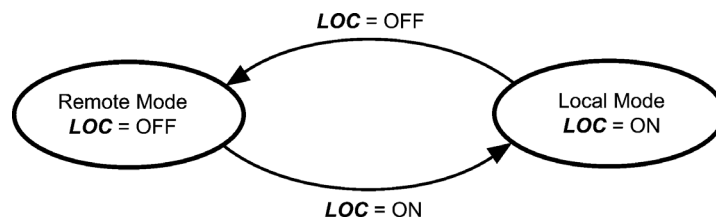

Figure 3.3-3 Transition between Remote and Local Modes by **LOC**

3.4 Programming Mode

The Programming mode provides you with the following functions--setting and checking function code data, monitoring maintenance information and checking input/output (I/O) signal status. The functions can be easily selected with the menu-driven system. Table 3.4-1 lists menus available in Programming mode. The leftmost digit (numerals) of each letter string on the LED monitor indicates the corresponding menu number and the remaining three digits indicate the menu contents.

When the inverter enters Programming mode from the second time on, the menu selected last in Programming mode will be displayed.

Table 3.4-1 Menus Available in Programming Mode

Menu #	Menu	LED monitor shows:	Main functions	Refer to:	
1	"Data Setting"	<i>1F__</i>	F codes (Fundamental functions)	Selecting each of these function codes enables its data to be displayed/changed.	Section 3.4.1
		<i>1E__</i>	E codes (Extension terminal functions)		
		<i>1C__</i>	C codes (Control functions)		
		<i>1P__</i>	P codes (Motor 1 parameters)		
		<i>1H__</i>	H codes (High performance functions)		
		<i>1H L</i>	H1 codes (100s) (High performance functions)		
		<i>1R__</i>	A codes (Motor 2 parameters)		
		<i>1J__</i>	J codes (Application functions 1)		
		<i>1J L</i>	J1 codes (100s) (PID functions)		
		<i>1d__</i>	d codes (Application functions 2)		
		<i>1U__</i>	U codes (Customizable logic functions)		
		<i>1U L</i>	U1 codes (100s) (Customizable logic functions)		
		<i>1y__</i>	y codes (Link functions)		
<i>1K__</i>	K code (Keypad functions)				
<i>1o__</i>	o codes (Optional functions) (Note)				
2	"Data Checking"	<i>2rEP</i>	Displays only function codes that have been changed from their factory defaults. You can refer to or change those function code data.	Section 3.4.2	
3	"Drive Monitoring"	<i>3oPE</i>	Displays the running information required for maintenance or test running.	Section 3.4.3	
4	"I/O Checking"	<i>4iLo</i>	Displays external interface information.	Section 3.4.4	
5	"Maintenance Information"	<i>5rHE</i>	Displays maintenance information including cumulative run time.	Section 3.4.5	
6	"Alarm Information"	<i>6rAL</i>	Displays the recent four alarm codes. You can refer to the running information at the time when the alarm occurred.	Section 3.4.6	
7	"Data Copying"	<i>7rPY</i>	Allows you to read or write function code data, as well as verifying it. (Only available with TP-E1U)	Section 3.4.7	
8	"Destination"	<i>8rES</i>	Setting the shipping destination region.	Section 4.4	
0	"Quick Setup"	<i>0rFL</i>	Displays only basic function codes to customize the inverter operation.	Section 3.4.8	

(Note) The "o" codes are displayed only when the corresponding option is mounted. For details, refer to the Instruction Manual for the corresponding option.





■ **Selecting menus to display**

The menu-driven system allows you to cycle through menus. To cycle through necessary menus only for simple operation, use function code E52 that provides a choice of the display modes as listed Table 3.4-2.

The factory default (E52 = 0) is to display three menus--Menu #1 "Data Setting," Menu #7 "Data Copying," and Menu #0 "Quick Setup," allowing no switching to any other menu.

Table 3.4-2 Keypad Display Mode Selection – Function Code E52

Data for E52	Mode	Menus selectable
0	Function code data setting mode (factory default)	Menu #1 "Data Setting" Menu #7 "Data Copying" Menu #0 "Quick Setup"
1	Function code data check mode	Menu #2 "Data Checking" Menu #7 "Data Copying"
2	Full-menu mode	Menus #0 through #8

Tip Press the  key to enter Programming mode and display menus. While cycling through the menus with the  /  key, select the desired menu item with the  key. Once the entire menu has been cycled through, the display returns to the first menu item.

3.4.1 Setting up function codes "Data Setting: *!F_* through *!D_*"

Menu #1 "Data Setting" (*!F_* through *!D_*) in Programming mode allows you to configure all function codes. (*!D_* is displayed only when the option is installed.)

To use "Data Setting," you need to set function code E52 to "0" (Function code data setting mode) or "2" (Full-menu mode).

Figure 3.4-1 shows the menu transition and the function code data change procedure in "Data Setting."

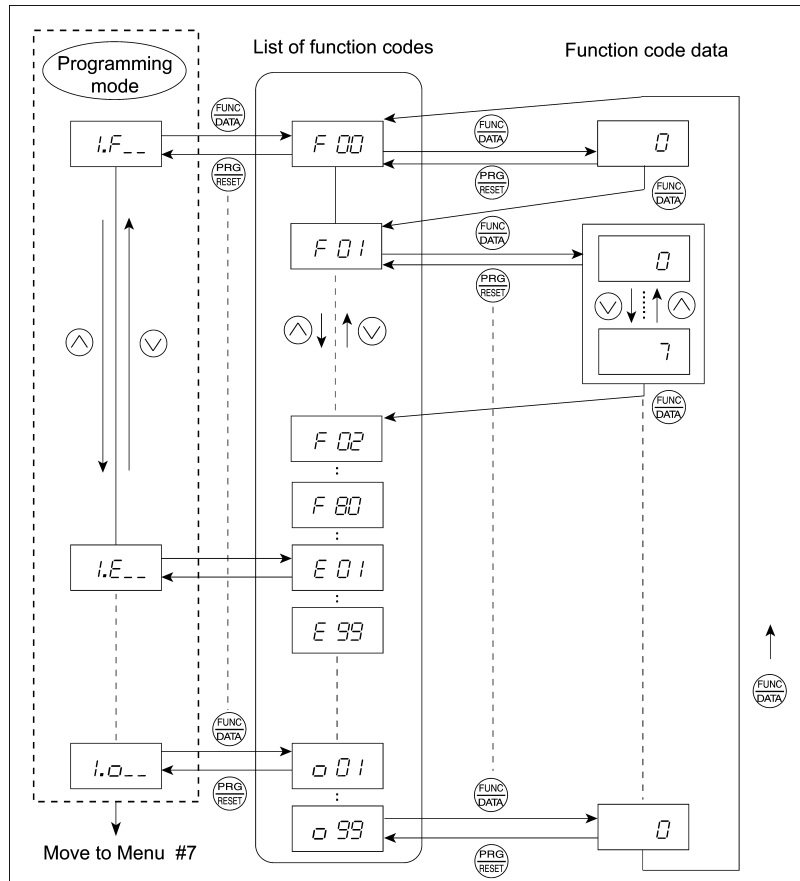

















Figure 3.4-1 Menu Transition and Function Code Data Change Procedure in Menu #1 "Data Setting"

Basic key operation

- (1) Turn the inverter ON. It automatically enters Running mode in which you press the  key to switch to Programming mode. The function selection menu appears.
- (2) Use the  and  keys to select the desired function code group from the choices *F*__ through *F*'__.
- (3) Press the  key to proceed to the list of function codes for the selected function code group.
- (4) Use the  and  keys to display the desired function code, then press the  key.
The data of this function code appears.
- (5) Change the function code data using the  and  keys.
- (6) Press the  key to establish the function code data.
The *SFLUE* appears (blinking) and the data will be saved in the memory inside the inverter. After that, the display will return to the function code list and then move to the next function code.
Pressing the  key instead of the  key cancels the change made to the data. The data reverts to the previous value, the display returns to the function code list, and the original function code reappears.
- (7) Press the  key to return to the menu from the function code list.

**Cursor movement**

When changing function code data, pressing the  key once blinks the least significant digit. After that, each time the  key is pressed, the cursor moves to the next higher digit where data can be changed. This cursor movement allows you to easily move the cursor to the desired digit and change the data in higher digits.

3.4.2 Checking changed function codes “Data Checking: *2rEP*”

Menu #2 “Data Checking” (*2rEP*) in Programming mode allows you to check function codes that have been changed. Only the function codes whose data has been changed from the factory defaults are displayed on the LED monitor. You can refer to the function code data and change it again if necessary.

To check function codes in Menu #2 “Data Checking,” you need to set function code E52 to “1” (Function code data check mode) or “2” (Full-menu mode).

The menu transition in “Data Checking” is the same as the one in Menu #1 “Data Setting.”

3.4.3 Monitoring the running status “Drive Monitoring: 3.0PE”

Menu #3 “Drive Monitoring” (3.0PE) is used to monitor the running status during maintenance and test running. The display items for “Drive Monitoring” are listed in Table 3.4-3. Figure 3.4-2 shows the menu transition in “Drive Monitoring.”

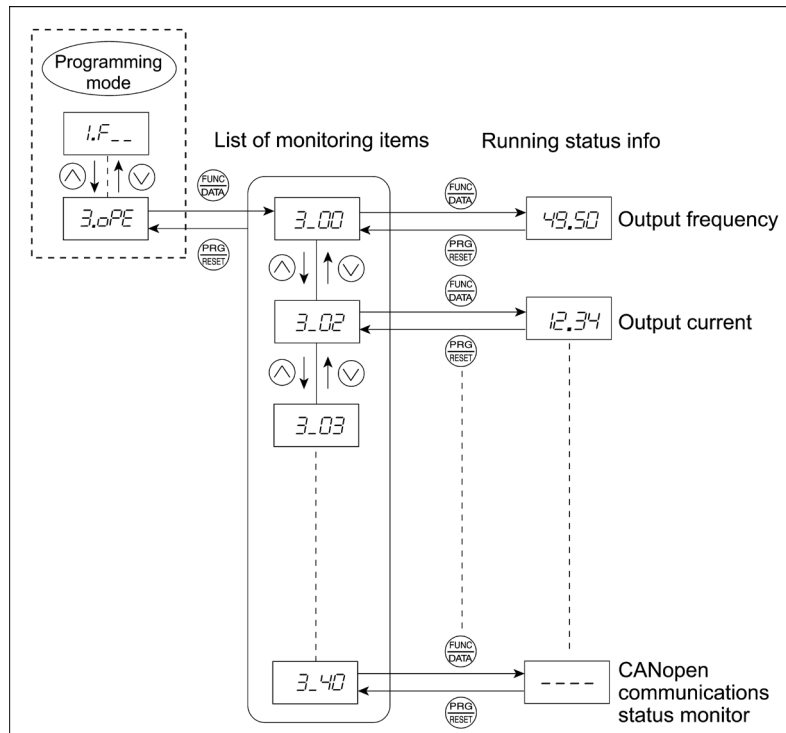

Figure 3.4-2 Menu Transition in Menu #3 “Drive Monitoring”

Basic key operation

To monitor the running status in “Drive monitoring,” set function code E52 to “2” (Full-menu mode) beforehand.

- (1) Turn the inverter ON. It automatically enters Running mode in which you press the key to switch to Programming mode. The function selection menu appears. (In this example, 0.FnL is displayed.)
- (2) Use the and keys to display “Drive Monitoring” (3.0PE).
- (3) Press the key to proceed to a list of monitoring items (e.g. 3.00).
- (4) Use the and keys to display the desired monitoring item, then press the key. The running status information for the selected item appears.
- (5) Press the key to return to the list of monitoring items. Press the key again to return to the menu.

Table 3.4-3 “Drive Monitoring” Display Items

LED monitor shows:	Item	Unit	Description
3.00	Output frequency 1	Hz	Output frequency before slip compensation
3.01	Output frequency 2	Hz	Output frequency after slip compensation
3.02	Output current	A	Output current
3.03	Output voltage	V	Output voltage
3.04	Calculated torque	%	Calculated output torque of the motor
3.05	Reference frequency	Hz	Frequency specified by a frequency command
3.06	Rotation direction	N/A	Rotation direction of current output F: forward, r: reverse, ----: stop
3.07	Running status	N/A	Running status in 4-digit hexadecimal format Refer to “ ■ Displaying running status (3.07) and running status 2 (3.23) ” on the next page.
3.08	Motor speed	r/min	Display value = (Output frequency Hz) × $\frac{120}{(\text{No. of poles})}$
			If the value is 10000 or greater, the x10 LED turns ON and the LED monitor shows one-tenth of the value.
3.09	Load shaft speed	r/min	Display value = (Output frequency Hz) × (Function code E50: Coefficient for speed indication) If the value is 10000 or greater, the x10 LED turns ON and the LED monitor shows one-tenth of the value.
3.10	PID command value	N/A	Virtual physical value (e.g., temperature or pressure) of the object to be controlled, which is converted from the PID command value using function code J106 and J107 data (PID display Maximum scale/ minimum scale) Display value = (PID command value (%)) / 100 * (Max. scale - Min. scale) + Min. scale If PID control is disabled, “----” appears.
3.11	PID feedback amount	N/A	Virtual physical value (e.g., temperature or pressure) of the object to be controlled, which is converted from the PID feedback amount using function code J106 and J107 data (PID display Maximum scale/ minimum scale) Display value = (PID feedback value (%)) / 100 * (Max. scale - Min. scale) + Min. scale If PID control is disabled, “----” appears.
3.12	Torque limit value A	%	Driving torque limit value A (based on motor rated torque)
3.13	Torque limit value B	%	Braking torque limit value B (based on motor rated torque)
3.14	Ratio setting	%	When this setting is 100%, the LED monitor shows 1.00 time of the value to be displayed. If no ratio setting is selected, “----” appears.
3.15	Line speed	m/min	Display value = (Output frequency Hz) × (Function code E50: Coefficient for speed indication) If the value is 10000 or greater, the x10 LED turns ON and the LED monitor shows one-tenth of the value.
3.16	(Not used.)	—	—
3.17	E point pulse count	Pulse	Displays the E point of positioning control in the pulse count. Refer to Chapter 5 “5.3.8 [7] Positioning control with pulse counter.”
3.18	Current position pulse	Pulse	Displays the current position pulse count. Refer to Chapter 5 “5.3.8 [7] Positioning control with pulse counter.”

Table 3.4-3 “Drive Monitoring” Display Items (Continued)

LED monitor shows:	Item	Unit	Description
3_19	Positioning deviation pulse	Pulse	Displays the pulse count deviation between the current position and S point. Refer to Chapter 5 “5.3.8 [7] Positioning control with pulse counter.”
3_20	Positioning control status	N/A	Displays the position control status shown in “Figure 5.3-18 Positioning Control Status Transition Model.”
3_21	PID output value	%	PID output value. (100% at the maximum frequency) If PID control is disabled, “----” appears.
3_22	Flux command value	%	Magnetic flux command value.
3_23	Running status 2	N/A	Running status 2 in 4-digit hexadecimal format Refer to “■ Displaying running status (3_07) and running status 2 (3_23)” given below.
3_25	Master-follower operation deviation	deg	Shows the current angle deviation. Refer to Chapter 5 “5.3.9 [2] Master-follower operation.”
3_29	PG feedback value	Hz	Shows the frequency detected by the PG in Hz regardless of the control method.
3_40	CANopen (built-in) communications status monitor	—	Communications status monitor of CANopen (built-in) For details, refer to Chapter 9 “9.2.15 Keypad LED operation monitor “3_40”.”
3_41	CANopen (built-in) bus status monitor	N/A	Shows the CANopen (built-in) bus status monitor. For details, refer to Chapter 9 “9.2.16 Keypad LED operation monitor “3_41”.”
3_42	CANopen (built-in) DSP402 state	N/A	Shows the transition status of the state machine defined in the DSP-402. For details, refer to Chapter 9 “9.2.17 Keypad LED operation monitor “3_42”.”

■ Displaying running status (3_07) and running status 2 (3_23)

To display the running status and running status 2 in 4-digit hexadecimal format, each state has been assigned to bits 0 to 15 as listed in Table 3.4-4 and Table 3.4-5 respectively. Table 3.4-6 shows the relationship between each of the status assignments and the LED monitor display.

Table 3.4-7 gives the conversion table from 4-bit binary to hexadecimal.

Table 3.4-4 Running Status (3_07) Bit Assignment

Bit	Notation	Content	Bit	Notation	Content
15	BUSY	“1” when function code data is being written.	7	VL	“1” under voltage limiting control.
14	WR	Always “0.”	6	TL	“1” under torque limiting control.
13		Always “0.”	5	NUV	“1” when the DC link bus voltage is higher than the under voltage level.
12	RL	“1” when communication is enabled (when ready for run and frequency commands via communications link).	4	BRK	“1” during braking.
11	ALM	“1” when an alarm has occurred.	3	INT	“1” when the inverter output is shut down.
10	DEC	“1” during deceleration.	2	EXT	“1” during DC braking.
9	ACC	“1” during acceleration.	1	REV	“1” during running in the reverse direction.
8	IL	“1” under current limiting control.	0	FWD	“1” during running in the forward direction.

Table 3.4-5 Running Status 2 (3_23) Bit Assignment

Bit	Notation	Content	Bit	Notation	Content
15	—	Driving a PM motor	7	—	Speed limiting (under torque control)
14	—	(Not used.)	6	—	(Not used.)
13			5	—	Motor selection
12			4	—	00: Motor 1 01: Motor 2
11			3	—	Inverter drive control 0000: V/f control with slip compensation inactive 0001: Vector control without speed sensor (Dynamic torque vector) 0010: V/f control with slip compensation active 0011: V/f control with speed sensor 0100: V/f control with speed sensor and auto torque boost 0101: Vector control for PMSM without speed sensor and magnetic pole position sensor 0110: Vector control for IM with speed sensor 1011: Torque control for IM (Vector control with speed sensor)
10			2	—	
9			1	—	
8			0	—	

Table 3.4-6 Running Status Display

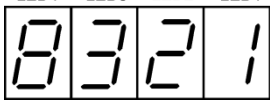
LED No.	LED4				LED3				LED2				LED1				
Bit	15	14	13	12	11	10	9	8	7	6	5	4	3	2	1	0	
Notation	BUSY	WR	RL		ALM	DEC	ACC	IL	VL	TL	NUV	BRK	INT	EXT	REV	FWD	
Example	Binary	1	0	0	0	0	0	1	1	0	0	1	0	0	0	0	1
	Hexadecimal on the LED monitor	<div style="display: flex; justify-content: space-around; align-items: center;"> LED4 LED3 LED2 LED1 </div> 															

■ Hexadecimal expression

A 4-bit binary number can be expressed in hexadecimal (1 hexadecimal digit). Table 3.4-7 shows the correspondence between the two notations. The hexadecimals are shown as they appear on the LED monitor.

Table 3.4-7 Binary and Hexadecimal Conversion

Binary				Hexadecimal	Binary				Hexadecimal
0	0	0	0	0	1	0	0	0	8
0	0	0	1	1	1	0	0	1	9
0	0	1	0	2	1	0	1	0	A
0	0	1	1	3	1	0	1	1	B
0	1	0	0	4	1	1	0	0	C
0	1	0	1	5	1	1	0	1	D
0	1	1	0	6	1	1	1	0	E
0	1	1	1	7	1	1	1	1	F

3.4.4 Checking I/O signal status “I/O Checking: 4.1.0”

Using Menu #4 “I/O Checking” (4.1.0) displays the I/O status of external signals including digital and analog I/O signals without using a measuring instrument. Table 3.4-8 lists check items available. The menu transition in “I/O Checking” is shown in Figure 3.4-3.

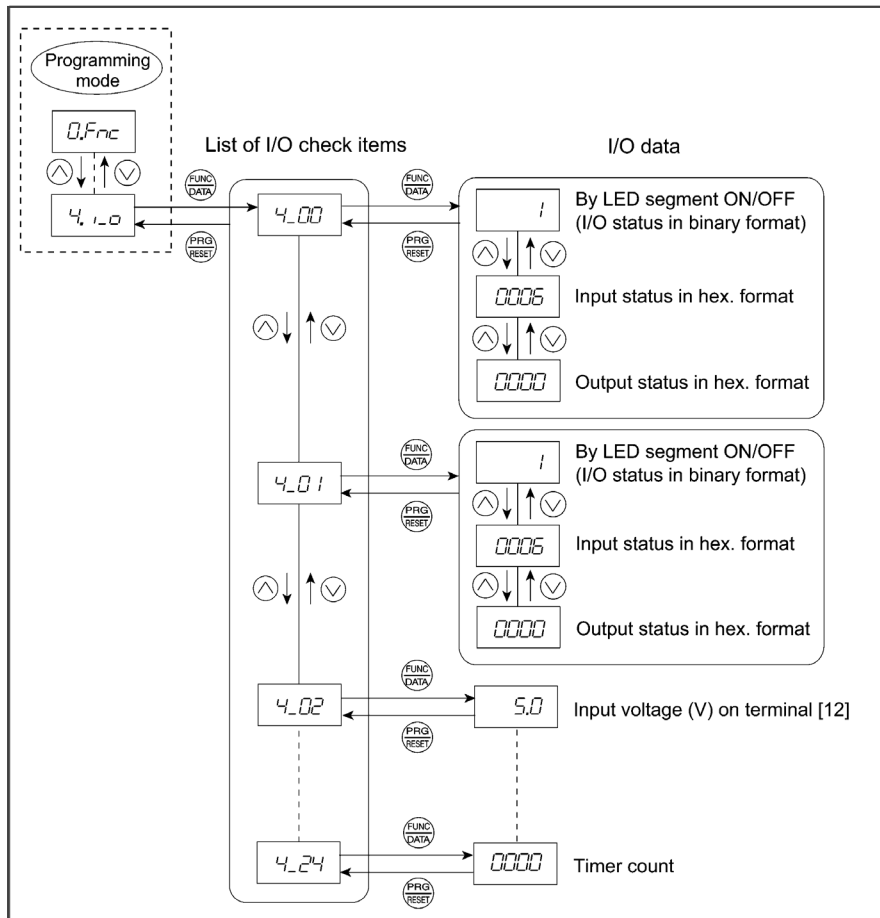

Figure 3.4-3 Menu Transition in Menu #4 “I/O Checking”

Basic key operation

To check the status of the I/O signals, set function code E52 to “2” (Full-menu mode) beforehand.

- (1) Turn the inverter ON. It automatically enters Running mode in which you press the key to switch to Programming mode. The function selection menu appears.
- (2) Use the and keys to display “I/O Checking” (4.1.0).
- (3) Press the key to proceed to a list of I/O check items (e.g. 4.00).
- (4) Use the and keys to display the desired I/O check item, then press the key.
The corresponding I/O check data appears. For the item 4.00 or 4.01, using the and keys switches the display method between the segment display (for external signal information in Table 3.4-9) and hexadecimal display (for I/O signal status in Table 3.4-10).
- (5) Press the key to return to the list of I/O check items. Press the key again to return to the menu.

Table 3.4-8 I/O Check Items

LED monitor shows:	Item	Unit	Description
4_00	I/O signals on the control circuit terminals	--	Shows the ON/OFF state of the digital I/O terminals. Refer to “■ Displaying control I/O signal terminals” on the next page for details.
4_01	I/O signals on the control circuit terminals under communications control	--	Shows the ON/OFF state of the digital I/O terminals that received a command via RS-485 or field bus option. Refer to “■ Displaying control I/O signal terminals” and “■ Displaying control I/O signal terminals under communications control” on the following pages for details.
4_02	Input voltage on terminal [12]	V	Shows the input voltage (with sign) on terminal [12] in volts (V).
4_03	Input current on terminal [C1] (C1 function)	mA	Shows the input current on terminal [C1] (C1 function) in milliamperes (mA).
4_04	Output voltage on terminal [FM] (FMV)	V	Shows the output voltage on terminal [FM] (FMV) in volts (V).
4_05	Output voltage on terminal [FM2] (FMV2)	V	Shows the output voltage on terminal [FM2] (FMV2) in volts (V). (exclusive to Model: -C/-GB)
4_06	Output frequency on terminal [FM] (FMP)	p/s	Shows the output pulse rate per unit of time on terminal [FM] (FMP) in (p/s). (If the value is 10000 or greater, the x10 LED turns ON and the LED monitor shows one-tenth of the value.)
4_07	Input voltage on terminal [C1] (V2 function)	V	Shows the input voltage on terminal [C1] (V2 function) in volts (V).
4_08	Output current on terminal [FM] (FMI)	mA	Shows the output current on terminal [FM] (FMI) in milliamperes (mA).
4_09	Output current on terminal [FM2] (FMI2)	mA	Shows the output current on terminal [FM2] (FMI2) in milliamperes (mA). (exclusive to Model: -C/-GB)
4_10	Option control circuit terminal (I/O)	--	Shows the ON/OFF state of the digital I/O terminals on the digital input and output interface cards (DIO options). Refer to “■ Displaying control I/O signal terminals on optional digital input and output interface cards” on page3-26 for details.
4_11	Terminal [X5] pulse input monitor	--	Shows the pulse rate of the pulse train signal on terminal [X5].
4_15	PG pulse rate (A/B phase signal from the reference PG)	p/s	Shows the pulse rate (p/s) of the A/B phase signal fed back from the reference PG.
4_16	PG pulse rate (Z phase signal from the reference PG)	p/s	Shows the pulse rate (p/s) of the Z phase signal fed back from the reference PG.
4_17	PG pulse rate (A/B phase signal from the slave PG)	p/s	Shows the pulse rate (p/s) of the A/B phase signal fed back from the slave PG.
4_18	PG pulse rate (Z phase signal from the slave PG)	p/s	Shows the pulse rate (p/s) of the Z phase signal fed back from the slave PG.
4_20	Input voltage on terminal [32]	V	Shows the input voltage on terminal [32] on the analog interface card (AIO option) in volts (V).
4_21	Input current on terminal [C2]	mA	Shows the input current on terminal [C2] on the analog interface card (AIO option) in milliamperes (mA).
4_22	Output voltage on terminal [AO]	V	Shows the output voltage on terminal [AO] on the analog interface card (AIO option) in volts (V).
4_23	Output current on terminal [CS]	mA	Shows the output current on terminal [CS] on the analog interface card (AIO option) in milliamperes (mA).
4_24	Customizable logic timer monitor	--	Monitors the timer or counter value in the customizable logic specified by U91.

■ **Displaying control I/O signal terminals**

The status of control I/O signal terminals can be displayed in two ways: with ON/OFF of each LED segment and in hexadecimal.

● **Displaying the I/O signal status with ON/OFF of each LED segment**

As shown in Table 3.4-9 and the figure below, each of segments “a” to “dp” on LED1 and LED2 lights when the corresponding digital input terminal circuit ([FWD], [REV], [X1] to [X5], [EN1] and [EN2]) is closed (ON); it goes OFF when it is open (OFF). Segment “a” or “b” on LED3 lights when the circuit between output terminal [Y1] or [Y2] and terminal [CMY] is closed, respectively; it goes OFF when the circuit is open. Segment “a” on LED4 is for terminals [30A/B/C] and lights when the circuit between terminals [30C] and [30A] is short-circuited (ON) and goes OFF when it is open.

 **Tip** If all terminal signals are OFF (open), segments “g” on all of LED1 to LED4 will light (“- - - -”).

Table 3.4-9 Display of I/O Signal Status with ON/OFF of each LED segment



Segment	LED4	LED3	LED2	LED1
a	30A/B/C	Y1-CMY	—	FWD
b	—	Y2-CMY	—	REV
c	—	—	—	X1
d	—	—	EN1	X2
e	—	—	EN2	X3
f	—	—	(XF) *	X4
g	—	—	(XR) *	X5
dp	—	—	(RST) *	—

—: No corresponding control circuit terminal exists

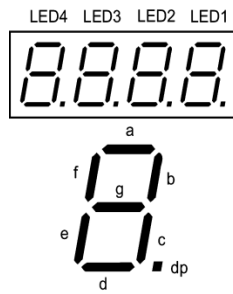
* (XF), (XR), and (RST) are assigned for communications control. Refer to “[■ Displaying control I/O signal terminals under communications control](#)” on page 3-26.

● **Displaying I/O signal status in hexadecimal**

Each I/O terminal is assigned to bit 15 through bit 0 as shown in Table 3.4-10. An unassigned bit is interpreted as “0.” Allocated bit data is displayed on the LED monitor as four hexadecimal digits (0 to F each).

On the FRENIC-Ace, digital input terminals [FWD] and [REV] are assigned to bits 0 and 1, respectively. Terminals [X1] through [X5] are assigned to bits 2 through 6. The bit is set to “1” when the corresponding input terminal is short-circuited (ON), and it is set to “0” when the terminal is open (OFF). For example, when [FWD] and [X1] are ON (short-circuited) and all the others are OFF (open), 0001 is displayed on LED4 to LED1.

Digital output terminals [Y1] and [Y2] are assigned to bits 0 through 3. Each bit is set to “1” when the output terminal [Y1] or [Y2] is short-circuited with [CMY] (ON), and “0” when it is open (OFF).

The status of the relay contact output terminals [30A/B/C] is assigned to bit 8. It is set to “1” when the circuit between output terminals [30A] and [30C] is closed, and “0” when the circuit between [30A] and [30C] is open.

For example, if [Y1] is ON, [Y2] is OFF, and the circuit between [30A] and [30C] is closed, then “0011” is displayed on the LED4 through LED1.

Table 3.4-10 presents bit assignment and an example of corresponding hexadecimal display on the 7-segment LED.

Table 3.4-10 Display of I/O Signal Status in Hexadecimal (Example)

LED No.		LED4				LED3				LED2				LED1			
Bit		15	14	13	12	11	10	9	8	7	6	5	4	3	2	1	0
Input terminal		(RST)*	(XR)*	(XF)*	EN2	EN1	—	—	—	—	X5	X4	X3	X2	X1	REV	FWD
Output terminal		—	—	—	—	—	—	—	30A/ B/C	—	—	—	—	—	—	Y2	Y1
Example	Binary	0	0	0	0	0	0	0	0	0	0	0	0	0	0	1	0
	Hexa- decimal on the LED monitor																

— : No corresponding control circuit terminal exists.

* (XF), (XR), and (RST) are assigned for communications control. Refer to “[■ Displaying control I/O signal terminals under communications control](#)” given below.

■ Displaying control I/O signal terminals under communications control

Under communications control, input commands (function code S06) sent via RS-485 or other optional communications can be displayed in two ways: “with ON/OFF of each LED segment” and “in hexadecimal.” The content to be displayed is basically the same as that for the control I/O signal terminal status display; however, (XF), (XR), and (RST) are added as inputs. Note that under communications control, the I/O display is in normal logic (using the original signals not inverted)

For details about input commands sent through the communications link, refer to the “RS-485 Communication User’s Manual” or the instruction manual of communication-related options as well.

■ Displaying control I/O signal terminals on optional digital input and output interface cards

The LED monitor can also show the signal status of the terminals on the optional digital input and output interface cards, same as the signal status of the control circuit terminals.

Table 3.4-11 lists the assignment of digital I/O signals to the LED segments.

Table 3.4-11 Display of I/O Signal Status with ON/OFF of each LED segment (Digital input and output interface cards)

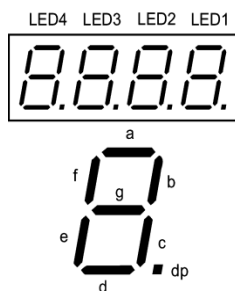

Segment	LED4	LED3	LED2	LED1
a	—	O1	I9	I1
b	—	O2	I10	I2
c	—	O3	I11	I3
d	—	O4	I12	I4
e	—	O5	I13	I5
f	—	O6	—	I6
g	—	O7	—	I7
dp	—	O8	—	I8

LED No.	LED4				LED3				LED2				LED1			
Bit	15	14	13	12	11	10	9	8	7	6	5	4	3	2	1	0
Input terminal	-	-	-	I13	I12	I11	I10	I9	I8	I7	I6	I5	I4	I3	I2	I1
Output terminal	-	-	-	-	-	-	-	-	O8	O7	O6	O5	O4	O3	O2	O1

3.4.5 Reading maintenance information “Maintenance Information: *S.CHE*”

Menu #5 “Maintenance Information” (*S.CHE*) contains information necessary for performing maintenance on the inverter. The menu transition in “Maintenance Information” is same as that in Menu #3 “Drive Monitoring.” (Refer to Section 3.4.3.)

Basic key operation

To view the maintenance information, set function code E52 to “2” (Full-menu mode) beforehand.









- (1) Turn the inverter ON. It automatically enters Running mode in which you press the  key to switch to Programming mode. The function selection menu appears.
- (2) Use the  and  keys to display “Maintenance Information” (*S.CHE*).
- (3) Press the  key to proceed to the list of maintenance items (e.g. *S_00*).
- (4) Use the  and  keys to display the desired maintenance item, then press the  key. The data of the corresponding maintenance item appears.
- (5) Press the  key to return to the list of maintenance items. Press the  key again to return to the menu.

Table 3.4-12 Display Items in “Maintenance Information”

LED Monitor shows:	Item	Description
<i>S_00</i>	Cumulative run time	Shows the content of the cumulative power-ON time counter of the inverter. Counter range: 0 to 65,535 hours Display: Upper 2 digits and lower 3 digits are displayed alternately. Example: <i>0</i> ⇔ <i>535H</i> (535 hours) <i>65</i> ⇔ <i>535H</i> (65,535 hours) The lower 3 digits are displayed with <i>H</i> (hour). When the count exceeds 65,535, the counter will be reset to “0” and start over again.
<i>S_01</i>	DC link bus voltage	Shows the DC link bus voltage of the inverter main circuit. Unit: V (volts)
<i>S_02</i>	Max. temperature inside the inverter	Shows the maximum temperature inside the inverter for every hour. Unit: °C (Temperatures below 20°C are displayed as 20°C.) The internal temperature is not measured at inverters of FRN0069E2■-2□ / FRN0044E2■-4□ / FRN0011E2■-7□ or below models, and therefore the temperature is not displayed.
<i>S_03</i>	Max. temperature of heat sink	Shows the maximum temperature of the inverter heat sink for every hour. Unit: °C (Temperatures below 20°C are displayed as 20°C.)
<i>S_04</i>	Max. effective output current	Shows the maximum current in RMS for every hour. Unit: A (amperes)
<i>S_05</i>	Capacitance of the DC link bus capacitor	Shows the current capacitance of the DC link bus capacitor (reservoir capacitor) in %, based on the capacitance when shipping as 100%. Refer to Chapter 7 “MAINTENANCE AND INSPECTION” for details. Unit: %

Table 3.4-12 Display Items in "Maintenance Information" (Continued)

LED Monitor shows:	Item	Description
5_06	Cumulative run time of electrolytic capacitors on the printed circuit boards	Shows the content of the cumulative run time counter of the electrolytic capacitors on the printed circuit boards, which is calculated by multiplying the cumulative run time count by the coefficient based on the surrounding temperature condition. Counter range: 0 to 99,990 hours Display range: 0 to 9999 (the x10 LED turns ON) Actual cumulative run time of electrolytic capacitors on the printed circuit boards (hours) = Displayed value x 10 When the count exceeds 99,990 the counter stops and the LED monitor sticks to 9999.
5_07	Cumulative run time of the cooling fan	Shows the content of the cumulative run time counter of the cooling fan. This counter does not work when the cooling fan ON/OFF control (function code H06) is enabled and the fan stops. The display method is the same as for 5_06 above.
5_08	Number of startups	Shows the content of the motor 1 startup counter (i.e., the number of run commands issued). Counter range: 0 to 65,530 times Display range: 0 to 9999 If the count exceeds 10,000, the x10 LED turns ON and the LED monitor shows one-tenth of the value. When the count exceeds 65,530, the counter will be reset to "0" and start over again.
5_09	Input watt-hour	Shows the input watt-hour of the inverter. Display range: 0.001 to 9999 Input watt-hour = Displayed value x 100 kWh To reset the integrated input watt-hour and its data, set function code E51 to "0.000." When the input watt-hour exceeds 999,900 kWh, the counter will be reset to "0."
5_10	Input watt-hour data	Shows the value expressed by "input watt-hour (1.000=100 kWh) x E51 (whose data range is 0.000 to 9,999)." Unit: None (Display range: 0.001 to 9999. The count cannot exceed 9999. (It will be fixed at 9,999 once the calculated value exceeds 9999.)) Depending on the value of integrated input watt-hour data, the decimal point on the LED monitor shifts to show it within the LED monitors' resolution. To reset the integrated input watt-hour data, set function code E51 to "0.000."
5_11	Number of RS-485 communications errors (COM port 1)	Shows the total number of errors that have occurred in RS-485 communication (COM port 1, connection to keypad) after the power is turned ON. Once the count exceeds 9999, the counter will be reset to "0."
5_12	Content of RS-485 communications error (COM port 1)	Shows the latest error that has occurred in RS-485 communication (COM port 1) in decimal. For error contents, refer to the "RS-485 Communication User's Manual."
5_13	Number of option errors 1	Shows the total number of errors that have occurred in the option. Once the count exceeds 9999, the counter will be reset to "0."

Table 3.4-12 Display Items in “Maintenance Information” (Continued)

LED Monitor shows:	Item	Description
5_14	Inverter's ROM version	Shows the inverter's ROM version as a 4-digit code.
5_15	Inverter's ROM version Sub CPU	Shows the inverter's Sub CPU ROM version as a 4-digit code. (Only type of FRN0020E2■-2□ / FRN0012E2■-4□ / FRN0011E2■-7□ or below)
5_16	Keypad's ROM version	Shows the keypad's ROM version as a 4-digit code.
5_17	Number of RS-485 communications errors (COM port 2)	Shows the total number of errors that have occurred in RS-485 communication (COM port 2, connection to terminal block) after the power is turned ON. Once the count exceeds 9999, the counter will be reset to “0.”
5_18	Content of RS-485 communications error (COM port 2)	Shows the latest error that has occurred in RS-485 communication (COM port 2, connection to terminal block) in decimal. For error contents, refer to the “RS-485 Communication User's Manual.”
5_19	Option's ROM version 1	Shows the ROM version of the option as a 4-digit code. If the option has no ROM, “----” appears on the LED monitor.
5_23	Cumulative run time of motor 1	Shows the content of the cumulative power-ON time counter of motor 1. Counter range: 0 to 99,990 hours Display range: 0 to 9999 (the x10 LED turns ON) Actual cumulative motor run time (hours) = Displayed value x 10 When the count exceeds 99,990, the counter will be reset to “0” and start over again.
5_24	Temperature inside the inverter (real-time value)	Shows the current temperature inside the inverter. Unit: °C The internal temperature is not measured at inverters of FRN0069E2■-2□ / FRN0044E2■-4□ / FRN0011E2■-7□ or below models, and therefore the temperature is not displayed.
5_25	Temperature of heat sink (real-time value)	Shows the current temperature of the inverter heat sink. Unit: °C
5_26	Lifetime of DC link bus capacitor (elapsed hours)	Shows the cumulative time during which a voltage is applied to the DC link bus capacitor. When the main power is shut down, the inverter automatically measures the discharging time of the DC link bus capacitor and corrects the elapsed time. The display method is the same as for 5_06 above.
5_27	Lifetime of DC link bus capacitor (remaining hours)	Shows the remaining lifetime of the DC link bus capacitor, which is estimated by subtracting the elapsed time from the lifetime (10 years). The display method is the same as for 5_06 above.
5_28	Cumulative run time of motor 2	Shows the content of the cumulative power-ON time counter of motor 2. The display method is the same as for 5_23 above.

Table 3.4-12 Display Items in “Maintenance Information” (Continued)

LED Monitor shows:	Item	Description
5_31	Remaining hours before the next maintenance 1	Shows the hours remaining before the next maintenance, which is estimated by subtracting the cumulative run time of motor 1 from the maintenance interval specified by H78. (This function applies to motor 1 only.) Display range: 0 to 9999 (the x10 LED turns ON) Actual remaining hours before maintenance = Displayed value x 10
5_32	Number of startups 2	Shows the content of the motor 2 startup counter (i.e., the number of run commands issued). The display method is the same as for 5_08 above.
5_35	Remaining startup times before the next maintenance 1	Shows the startup times remaining before the next maintenance, which is estimated by subtracting the number of startups from the preset startup count for maintenance specified by H79. (This function applies to motor 1 only.) The display method is the same as for 5_08 above.
5_36	Light alarm factor (Latest)	Shows the factor of the latest light alarm as an alarm code. For details, refer to Chapter 6, “6.1 Protective Functions.”
5_37	Light alarm factor (Last)	Shows the factor of the last light alarm as an alarm code. For details, refer to Chapter 6 “6.1 Protective Function.”
5_38	Light alarm factor (2nd last)	Shows the factor of the 2nd last light alarm as an alarm code. For details, refer to Chapter 6 “6.1 Protective Function.”
5_39	Light alarm factor (3rd last)	Shows the factor of the 3rd last light alarm as an alarm code. For details, refer to Chapter 6 “6.1 Protective Function.”
5_40	Option error factor 1	Shows the factor of the error that has occurred in the option being connected to the A-port.
5_45	Number of built-in CAN send errors	Shows the number of sending errors that occurred in the built-in CAN communication. The number of errors is expressed by “0” to “FFFF”. “FFFF” shows the upper limit.
5_46	Number of built-in CAN receive errors	Shows the number of receiving errors that occurred in the built-in CAN communication. The number of errors is expressed by “0” to “FFFF”. “FFFF” shows the upper limit.

3.4.6 Reading alarm information “Alarm Information: *E.AL*”

Menu #6 “Alarm Information” (*E.AL*) shows the causes of the past 4 alarms with an alarm code. Further, it is also possible to display alarm information that indicates the status of the inverter when the alarm occurred. Figure 3.4-4 shows the menu transition in “Alarm Information” and Table 3.4-13 lists the details of the alarm information.

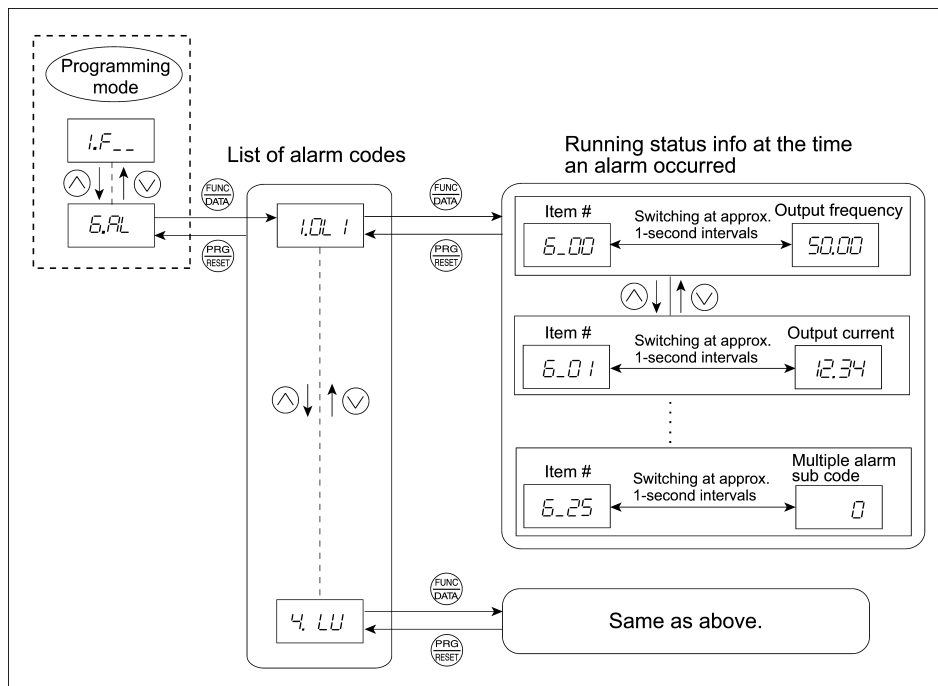

Figure 3.4-4 Menu Transition in Menu #6 “Alarm Information”

Basic key operation

To view the alarm information, set function code E52 to “2” (Full-menu mode) beforehand.

- (1) Turn the inverter ON. It automatically enters Running mode in which you press the key to switch to Programming mode. The function selection menu appears.
- (2) Use the or key to display “Alarm Information” (*E.AL*).
- (3) Press the key to proceed to the list of alarm codes (e.g. *1.OL 1*).
In the list of alarm codes, the alarm information for the last 4 alarms is saved as an alarm history.
- (4) Each time the or key is pressed, the last 4 alarms are displayed beginning with the most recent one in the order of *1*, *2*, *3*, and *4*.
- (5) Press the key with an alarm code being displayed.
The item number (e.g. *6_00*) and the inverter status information (e.g. Output frequency) at the time of the alarm occurrence alternately appear at approx. 1-second intervals.
Pressing the and keys displays other item numbers (e.g. *6_01*) and the status information (e.g. Output current) for that alarm code.
- (6) Press the key to return to the list of alarm codes. Press the key again to return to the menu.

Table 3.4-13 Display Items in “Alarm Information”

LED monitor shows: (item No.):	Item	Description
6.00	Output frequency	Output frequency before slip compensation when alarm occurred.
6.01	Output current	Output current when alarm occurred. Display unit: A (Amperes)
6.02	Output voltage	Output voltage when alarm occurred. Display unit: V (Volts)
6.03	Calculated torque	Calculated motor output torque when alarm occurred.
6.04	Reference frequency	Frequency specified by frequency command when alarm occurred.
6.05	Rotation direction	Shows the current rotation direction when alarm occurred. F: forward, r: reverse, ---: stop
6.06	Running status	Running status when alarm occurred as four hexadecimal digits. Refer to “■ Displaying running status (3.17.9) and running status 2 (3.23.9) in Section 3.4.3 on page 3-21 for details.
6.07	Cumulative run time	Shows the content of the cumulative power-ON time counter of the inverter when alarm occurred. Counter range: 0 to 65,535 hours Display: Upper 2 digits and lower 3 digits are displayed alternately. Example: 0 ⇔ 535H (535 hours) 65 ⇔ 535H (65,535 hours) The lower 3 digits are displayed with H (hour). When the count exceeds 65,535, the counter will be reset to “0” and start over again.
6.08	No. of startups	Shows the content of the motor startup counter (i.e., the number of run commands issued) when alarm occurred. Counter range: 0 to 65,530 times Display range: 0 to 9999 If the count exceeds 10,000, the x10 LED turns ON and the LED monitor shows one-tenth of the value. When the count exceeds 65,530, the counter will be reset to “0” and start over again.
6.09	DC link bus voltage	Shows the DC link bus voltage of the inverter main circuit when alarm occurred. Unit: V (volts)
6.10	Temperature inside the inverter	Shows the temperature inside the inverter when alarm occurred. Unit: °C The internal temperature is not measured at inverters of FRN0069E2■-2□ / FRN0044E2■-4□ / FRN0011E2■-7□ or below capacity models, and therefore the temperature is not displayed.
6.11	Max. temperature of heat sink	Shows the temperature of the inverter heat sink when alarm occurred. Unit: °C
6.12	Terminal I/O signal status (displayed with ON/OFF of LED segments)	Shows the ON/OFF states of the digital I/O terminals when alarm occurred.
6.13	Terminal input signal status (in hexadecimal)	For the contents of the display, refer to “Table 3.4-9 Display” and “Table 3.4-10 Display of I/O Signal Status in Hexadecimal (Example)” in 3.4.4 Checking I/O signal status “I/O Checking: 4.1.0”.
6.14	Terminal output signal status (in hexadecimal)	
6.15	No. of consecutive occurrences	Shows how many times the same alarm has occurred consecutively.

LED monitor shows: (item No.):	Item	Description
5.15	Multiple alarm 1	Simultaneously occurring alarm code (1) ("----" is displayed if no alarm has occurred.)
5.17	Multiple alarm 2	Simultaneously occurring alarm code (2) ("----" is displayed if no alarm has occurred.)
5.18	Terminal I/O signal status under communications control (displayed with the ON/OFF of LED segments)	Shows the ON/OFF state of the digital I/O terminals under RS-485 communications control when alarm occurred. Refer to ■ Displaying control I/O signal terminals under communications control in "3.4.4 Checking I/O signal status "I/O Checking: 4.1.0" for details.
5.19	Terminal input signal status under communications control (in hexadecimal)	
5.20	Terminal output signal status under communications control (in hexadecimal)	
5.21	Error sub code	Secondary error code for an alarm.
5.22	Running status 2	Running status 2 when alarm occurred as four hexadecimal digits. For details, refer to "Table 3.4-5 Running Status 2 (3.23) Bit Assignment" in "3.4.3 Monitoring the running status "Drive Monitoring: 3.0FE"."
5.23	Detected speed	Shows the detected speed value when alarm occurred.
5.24	Running status 3	Running status 3 when alarm occurred as four hexadecimal digits. For details, refer to "Table 3.4-14 Running Status 3 (3.24) Bit Assignment" given below.
5.25	Multiple alarm sub code	Secondary error code for a multiple alarm.

Note When the same alarm occurs repeatedly in succession, the alarm information for the first and the most recent occurrences will be preserved and the information for other occurrences in-between will be discarded. The number of consecutive occurrences will be preserved as the first alarm information.

Table 3.4-14 Running Status 3 (3.24) Bit Assignment

Bit	Notation	Content	Bit	Notation	Content
15	—	Always "0."	7	FAN	"1" when the fan is in operation.
14	ID2	"1" when current 2 is detected.	6	KP	"1" during keypad operation.
13	IDL	"1" when low current is detected.	5	OL	"1" when a motor overload early warning is issued.
12	ID	"1" when current is detected.	4	IPF	"1" during auto-restarting after momentary power failure.
11	OLP	"1" under overload prevention control.	3	SWM2	"1" when motor 2 is selected.
10	LIFE	"1" when a lifetime early warning is issued.	2	RDY	"1" when the inverter is ready to run.
9	OH	"1" when a heat sink overheat early warning is issued.	1	FDT	"1" when frequency is detected.
8	TRY	"1" during auto-resetting.	0	FAR	"1" when a frequency arrival signal is issued.

3.4.7 Copying data “Data Copying: *n.CPY*”

The data copy function can only be used when the keypad with USB (option: TP-E1U) is connected. Menu #7 “Data Copying” is used to read function code data out of an inverter for storing it in the keypad or writing it into another inverter. It is also used to verify the function code data stored in the keypad with the one configured in the inverter. The keypad serves as a temporary storage media.

In addition, using Menu #7 allows you to store the running status information in the keypad, detach the keypad from the inverter, connect it to a PC running FRENIC Loader at an office or off-site place, and check the inverter running status without removing the inverter itself.

To store the inverter running status information into the keypad, use “Read data” (read) or “Read inverter running information” (chec) function. For details on how to connect the keypad to a PC and check the inverter running status information stored in the keypad, refer to the FRENIC Loader Instruction Manual.

Figure 3.4-5 shows the menu transition in Menu #7 “Data Copying.” The keypad can hold function code data for a single inverter.

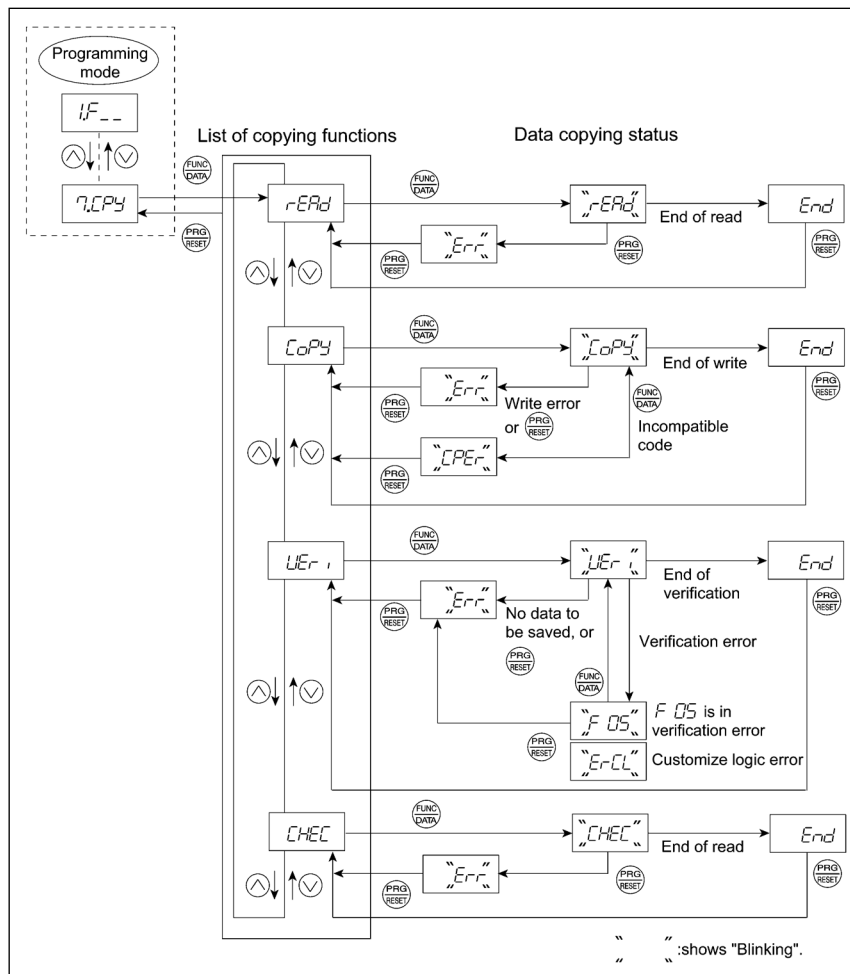

Figure 3.4-5 Menu Transition in Menu #7 “Data Copying”

Basic keying operation















- (1) Turn the inverter ON. It automatically enters Running mode. In that mode, press the  key to switch to Programming mode. The function selection menu appears.
- (2) Use the  and  keys to display "Data Copying" (*CPY*).
- (3) Press the  key to proceed to the list of data copying functions (e.g. *rERd*).
- (4) Use the  and  keys to select the desired function, then press the  key to execute the selected function. (e.g. *rERd* will blink.)
- (5) When the selected function has been completed, *end* appears. Press the  key to return to the list of data copying functions. Press the  key again to return to the menu.

Table 3.4-15 below lists details of the data copying functions.





Table 3.4-15 List of Data Copying Functions

Display on LED Monitor	Function	Description
<i>rERd</i>	Read data	<p>Reads the function code data out of the inverter's memory and stores it into the keypad memory.</p> <p>Also reads out inverter's current running status information which can be checked by FRENIC Loader, such as information of I/O, system, alarm, and running status.</p> <p>Pressing the  key during a read operation (when <i>rERd</i> is blinking) immediately aborts the operation and displays <i>Err</i> (blinking).</p> <p>If this happens, the entire contents of the memory of the keypad will be completely cleared.</p>
<i>CPY</i>	Write data	<p>Writes data stored in the keypad memory into the inverter's memory.</p> <p>If you press the  key during a write operation (when <i>CPY</i> is blinking), the write operation that is under way will be aborted and <i>Err</i> will appear (blinking). If this happens, the contents of the inverter's memory (i.e., function code data) have been partly updated and remain partly old. Therefore, do not operate the inverter. Instead, perform initialization or rewrite the entire data.</p> <p>If this function does not work, refer to "■ If data copying does not work" on page 3-36.</p> <p>After the copy is completed, the inverter Verifies data automatically. Displays the function code that was not been copied when copying in case that the model and voltage capacity is different.</p>
<i>VER</i>	Verify data	<p>Verifies (compares) the data stored in the keypad memory with that in the inverter's memory.</p> <p>If any mismatch is detected, the verify operation will be aborted, with the function code that differs displayed blinking. Pressing the  key again causes the verification to continue from the next function code.</p> <p>Pressing the  key during a verify operation (when <i>VER</i> is blinking) immediately aborts the operation and displays <i>Err</i> (blinking).</p> <p><i>Err</i> appears blinking also when the keypad does not contain any valid data.</p>
<i>Prd</i>	Enable Data protection	<p>Enables the Data protection of data stored in the keypad's memory.</p> <p>In this state, you cannot read any data stored in the inverter's memory, but can write data into the memory and verify data in the memory.</p> <p>Upon pressing the  key the inverter immediately displays <i>Err</i>.</p>
<i>CHEC</i>	Read inverter running information	<p>Reads out inverter's current running status information that can be checked by FRENIC Loader, such as information of I/O, system, alarm, and running status, excluding function code data.</p> <p>Use this command when the function code data saved in the keypad should not be overwritten and it is necessary to keep the previous data.</p> <p>Pressing the  key during a read operation (<i>CHEC</i> blinking) immediately aborts the operation and displays <i>Err</i> (blinking).</p>

■ **If data copying does not work**

Check whether *Err* or *CPER* or *ErCL* is blinking.

Table 3.4-16 List of Data Copying error



Display on LED Monitor	Error content	Description
<i>Err</i>	Write data error	<p>Error generated during <i>COPY</i> (Write data) operation.</p> <p>If <i>Err</i> is blinking (a write error), any of the following problems has arisen:</p> <ul style="list-style-type: none"> • No data exists in the keypad memory. (No data read operation has been performed since shipment, or a data read operation has been aborted.) • Data stored in the keypad memory contains any error. • The models of copy source and destination inverters are different. • A data write operation has been performed while the inverter is running. • The copy destination inverter is data-protected. (function code F00 = 1) • In the copy destination inverter, the “Enable write from keypad” command WE-KP is OFF. • A data read operation has been performed for the inverter whose data protection was enabled.
<i>CPER</i>	Write data error	<p>Error generated during <i>COPY</i> (Write data) operation.</p> <p>If <i>CPER</i> is blinking, any of the following problems has arisen:</p> <ul style="list-style-type: none"> • The function codes stored in the keypad and ones registered in the inverter are not compatible with each other. (Either of the two may have been revised or upgraded in a non-standard or incompatible manner.) • Press  to continue <i>COPY</i> (Write data) operation. • Press  to discontinue <i>COPY</i> (Write data) operation.
<i>ErCL</i>	Verify data error	<p>Error generated during <i>VER</i>, (Verify data) operation.</p> <p>If <i>ErCL</i> is blinking, any of the following problems has arisen:</p> <ul style="list-style-type: none"> • The number of customizable logic function codes stored in the keypad differs from the number of customizable logic function codes in the inverter. • Press  to continue <i>VER</i>, (Verify data) operation. • Press  to discontinue <i>VER</i>, (Verify data) operation.

■ Data protection

You can protect data saved in the keypad from unexpected modifications. Enabling the data protection changes the display on the “Data Copying” function list from *rERd* to *Prd*, and disables to read data from the inverter.

To enable or disable the data protection, follow the next steps.

- (1) Select the “Data Copying” (*LCPY*) on the function selection menu in Programming mode.
- (2) When the *LCPY* is displayed, holding the  key down for at least 5 seconds alternates data protection status between enabled or disabled.

Note For switching the data protection status, be sure to hold the  key down for at least 5 seconds. Once the key is released within 5 seconds, press the  key to go back to the *LCPY* display and perform the keying operation again.

- Enabling the disabled data protection

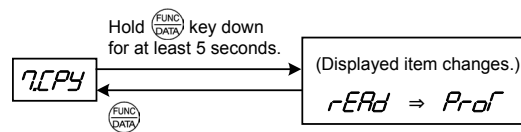

While *LCPY* is displayed, holding down the  key for at least 5 seconds shows *rERd* for 5 seconds and then switches to *Prd*, enabling the data protection.

- Disabling the enabled data protection

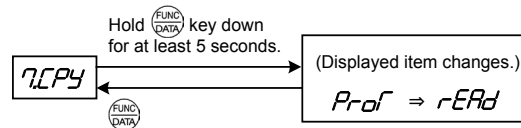

While *LCPY* is displayed, holding down the  key for at least 5 seconds shows *Prd* for 5 seconds and then switches to *rERd*, disabling the data protection.

The following are restrictions and special notes concerning “Data Copying.”

3.4.8 Setting up basic function codes quickly “Quick Setup: *QFnC*”

Menu #0 “Quick Setup” in Programming mode allows you to quickly display and set up a predetermined basic set of function codes.

To use Menu #0 “Quick Setup,” you need to set function code E52 to “0” (Function code data setting mode) or “2” (Full-menu mode).

The predefined set of function codes that are subject to quick setup is stored in the inverter.

Figure 3.4-6 shows the menu transition in “Quick Setup” and function code data changing procedure.

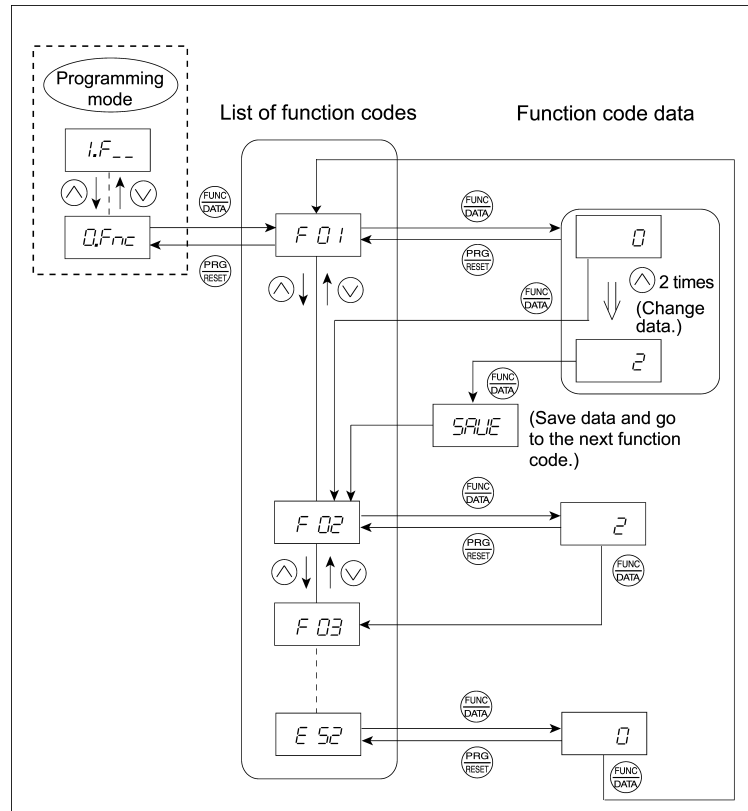









Figure 3.4-6 Menu Transition in Menu #0 “Quick Setup” and Function Code Data Changing Procedure

Basic key operation

This section gives a description of the basic key operation in “Quick Setup,” following the example of the function code data changing procedure shown in Figure 3.4-6.

This example shows you how to change function code F01 data (Frequency setting 1) from the factory default “ \triangle / ∇ ” keys on keypad (F01 = 0) to “Current input to terminal [C1] (C1 function) (4 to 20 mA DC) (F01 = 2).”

- (1) Turn the inverter ON. It automatically enters Running mode in which you press the  key to switch to Programming mode. The function selection menu appears. (In this example, \square FR \square is displayed.)
- (2) If anything other than \square FR \square is displayed, use the \triangle and ∇ keys to display \square FR \square .
- (3) Press the  key to proceed to the list of function codes.
- (4) Use the \triangle and ∇ keys to display the desired function code (F \square 1 in this example), then press the  key. The data of this function code appears. In this example, data \square of F \square 1 appears.
- (5) Change the function code data using the \triangle and ∇ keys. In this example, press the \triangle key two times to change data \square to \square .
- (6) Press the  key to establish the function code data. The *SAVE* appears (blinking) and the data will be saved in the memory inside the inverter. After that, the display will return to the function code list and then move to the next function code. In this example, F \square 2. Pressing the  key instead of the  key cancels the change made to the data. The data reverts to the previous value, the display returns to the function code list, and the original function code reappears.
- (7) Press the  key to return to the menu from the function code list.

 **Tip** **Cursor movement**

When changing function code data, pressing the  key moves the cursor to the desired digit and change the data in that digit is done in the same way as with the frequency setting. This action is called “Cursor movement.”

 **Tip** It is possible to change or add function code items subject to quick setup. For details, consult your Fuji Electric representatives.

3.5 Alarm Mode

If an abnormal condition arises, the protective function is invoked and issues an alarm, then the inverter automatically enters Alarm mode. At the same time, an alarm code appears on the LED monitor.

3.5.1 Releasing the alarm and switching to Running mode

Remove the cause of the alarm and press the key to release the alarm and return to Running mode. The alarm can be removed using the key only when the alarm code is displayed.

3.5.2 Displaying the alarm history

It is possible to display the most recent 3 alarm codes in addition to the one currently displayed. Previous alarm codes can be displayed by pressing the key while the current alarm code is displayed.

3.5.3 Displaying the status of inverter at the time of alarm

When the alarm code is displayed, you may check various running status information when the alarm occurred (output frequency and output current, etc.) by pressing the key. The item number and data for each running status information will be displayed alternately.

Further, you can view various information items on the running status of the inverter using the key. The information displayed is the same as for Menu #6 “Alarm Information” in Programming mode. Refer to Table 3.4-13 in “3.4.6 Reading alarm information “Alarm Information: *SR*”.”

Pressing the key while the running status information is displayed returns to the alarm code display.

Note When the running status information is displayed after removal of the alarm cause, pressing the key twice returns to the alarm code display and releases the inverter from the alarm state. This means that the motor starts running if a run command has been received by this time.

3.5.4 Switching to Programming mode

You can also switch to Programming mode by pressing “ + ” keys” simultaneously with the alarm displayed, and modify the function code data.

Figure 3.5-1 summarizes the possible transitions between different menu items.

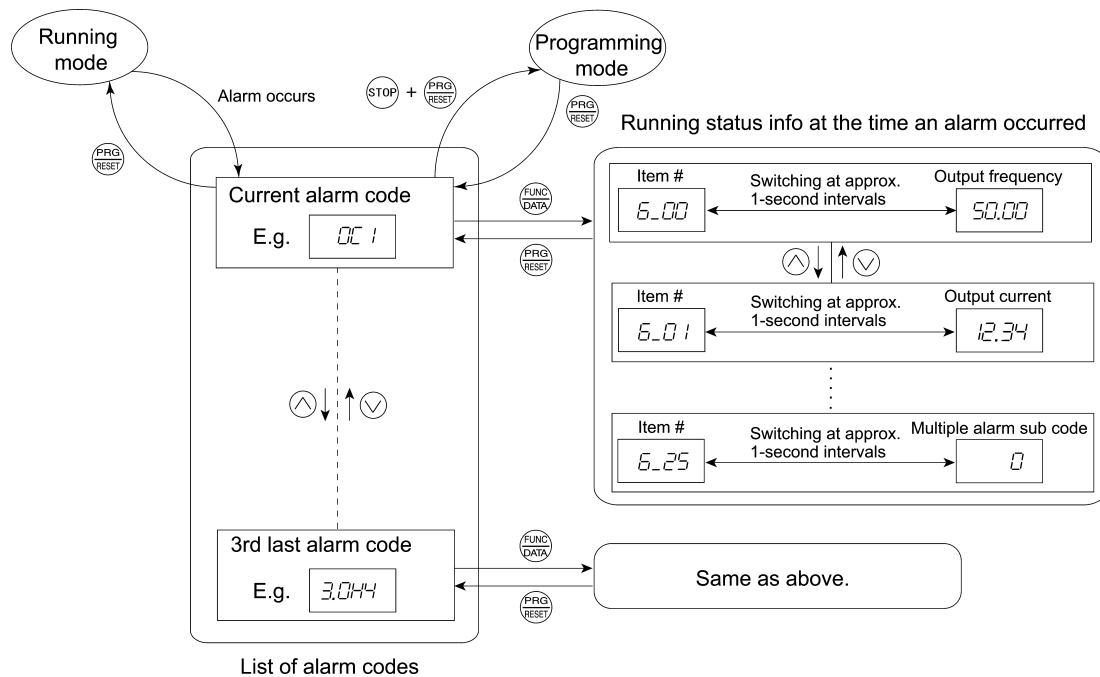

Figure 3.5-1 Menu Transition in Alarm Mode

Chapter 4

TEST RUN PROCEDURE

This chapter describes basic settings required for making a test run.

Contents

4.1	Test Run Procedure Flowchart	4-1
4.2	Checking Prior to Powering On	4-2
4.3	Powering ON and Checking	4-3
4.4	Destination setting	4-4
4.5	Switching the Applicable Motor Rating (ND, HD, HND and HHD Modes)	4-6
4.6	Selecting a Desired Motor Drive Control	4-8
4.6.1	V/f control with slip compensation inactive for IM	4-8
4.6.2	Vector control without speed sensor (Dynamic torque vector) for IM	4-8
4.6.3	V/f control with slip compensation active for IM	4-9
4.6.4	V/f Control with speed sensor for IM	4-9
4.6.5	V/f Control with speed sensor with Auto Torque Boost for IM	4-9
4.6.6	Vector Control with speed sensor for IM	4-9
4.6.7	Vector Control without speed sensor and magnetic pole position sensor for PMSM	4-10
4.7	Performance Comparison for Drive Controls (Summary)	4-11
4.8	Configuring Function Codes for Drive Controls	4-12
4.8.1	Driving an Induction Motor (IM)	4-13
[1]	Driving a non-Fuji motor or Fuji non-standard IM under the V/f control	4-13
[2]	Driving a Fuji general-purpose IM under the V/f control	4-14
[3]	Driving an IM under the V/f control with speed sensor	4-15
[4]	Driving a non-Fuji motor or Fuji non-dedicated IM under vector control with/without speed sensor	4-16
[5]	Driving a Fuji dedicated IM (MVK series) under vector control with speed sensor	4-20
4.8.2	Driving a permanent magnet synchronous motor (PMSM) without pole sensor and magnetic pole position sensor	4-21
[1]	Driving a non-Fuji PMSM	4-21
[2]	Driving a Fuji dedicated PMSM (GNB2 series)	4-26
[3]	Driving a Fuji non-dedicated PMSM (non-GNB2 series)	4-26
4.9	Running the Inverter for Motor Operation Check	4-27
4.9.1	Test run procedure	4-27
4.9.2	Check points during a test run	4-27
4.9.3	Modification of motor control function code data	4-28

4.10	Selecting a Frequency Command Source	4-30
4.10.1	Setting up a frequency command from the keypad	4-30
4.10.2	Setting up a frequency command with an external potentiometer	4-30
4.10.3	Setting up a frequency command with multistep frequency selection	4-31
4.11	Selecting a Run Command Source	4-32
4.11.1	Setting up a run command from the keypad	4-32
4.11.2	Setting up a run command with digital input signals (terminals [FWD] and [REV])	4-32

4.1 Test Run Procedure Flowchart

Make a test run of the motor using the flowchart given below. This chapter describes the test run procedure with motor 1 dedicated function codes that are marked with an asterisk (*). For motor 2, replace those function codes with asterisk with motor 2 dedicated ones.

 For the function codes dedicated to motor 2, see Chapter 5 “FUNCTION CODES.”

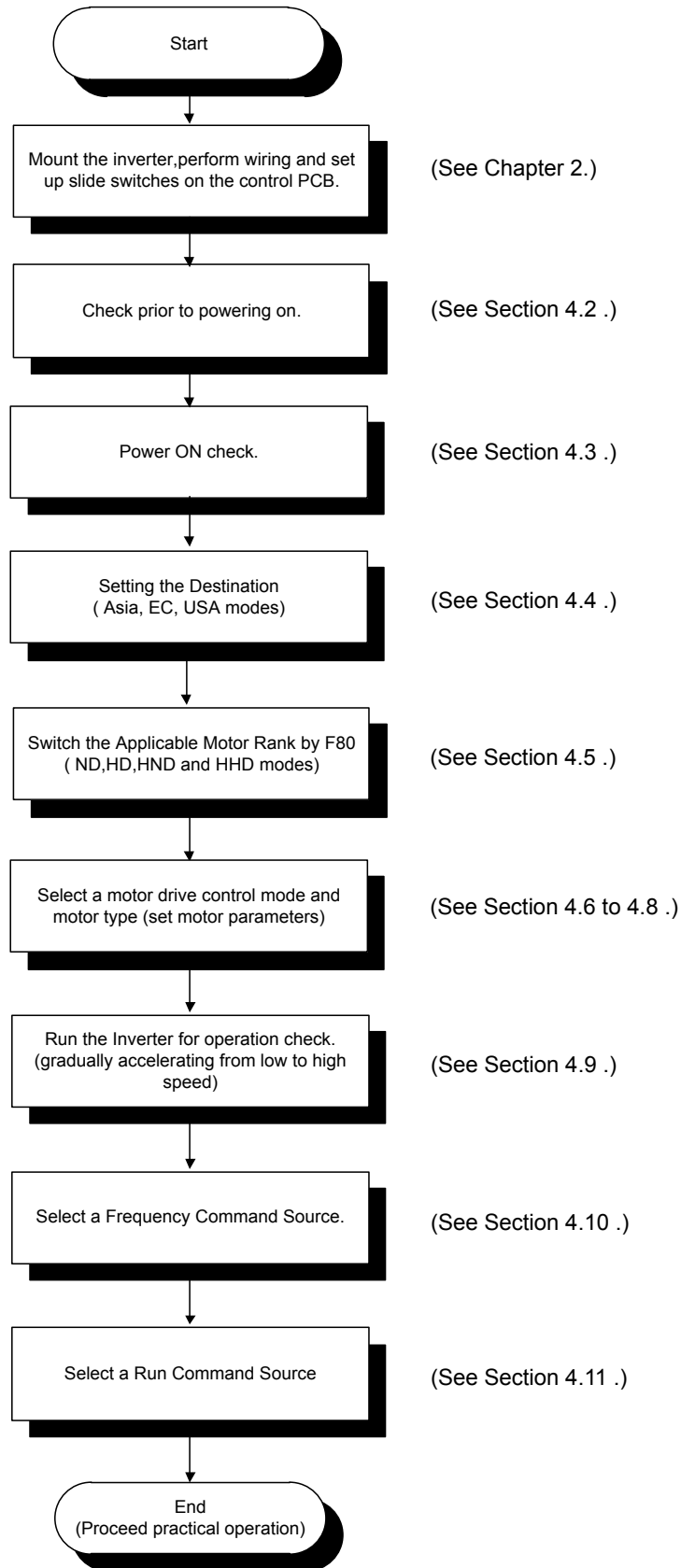

Figure 4.1-1 Test Run Procedure

4.2 Checking Prior to Powering On

Check the following before powering on the inverter.

- (1) Check that the wiring is correct.

Especially check the wiring to the inverter input terminals (L1/R, L2/S, L3/T or L1/L, L2/N) and output terminals (U, V, and W). Also check that the grounding wires are connected to the grounding terminals (⊕G) correctly. See Figure 4.2-1.

⚠ WARNING

- Never connect power supply wires to the inverter output terminals U, V, and W. Doing so and turning the power ON breaks the inverter.
- Be sure to connect the grounding wires of the inverter and the motor to the ground electrodes.

Otherwise, an electric shock could occur.

- (2) Check the control circuit terminals and main circuit terminals for short circuits or ground faults.
- (3) Check for loose terminals, connectors and screws.
- (4) Check that the motor is separated from mechanical equipment.
- (5) Make sure that all switches of devices connected to the inverter are turned OFF. Powering on the inverter with any of those switches being ON may cause an unexpected motor operation.
- (6) Check that safety measures are taken against runaway of the equipment, e.g., a defense to prevent people from access to the equipment.
- (7) Check that a power factor correction DC reactor (DCR) is connected to the DC reactor terminals P1 and P(+). (ND-mode in case of inverters FRN0139E2■-4□ or above, HD-/HND-mode in case of FRN0168E2■-4□ or above, and HHD-mode in case of FRN0203E2■-4□ or above must be used with a DCR. Be sure to connect the DCR to the inverter.)

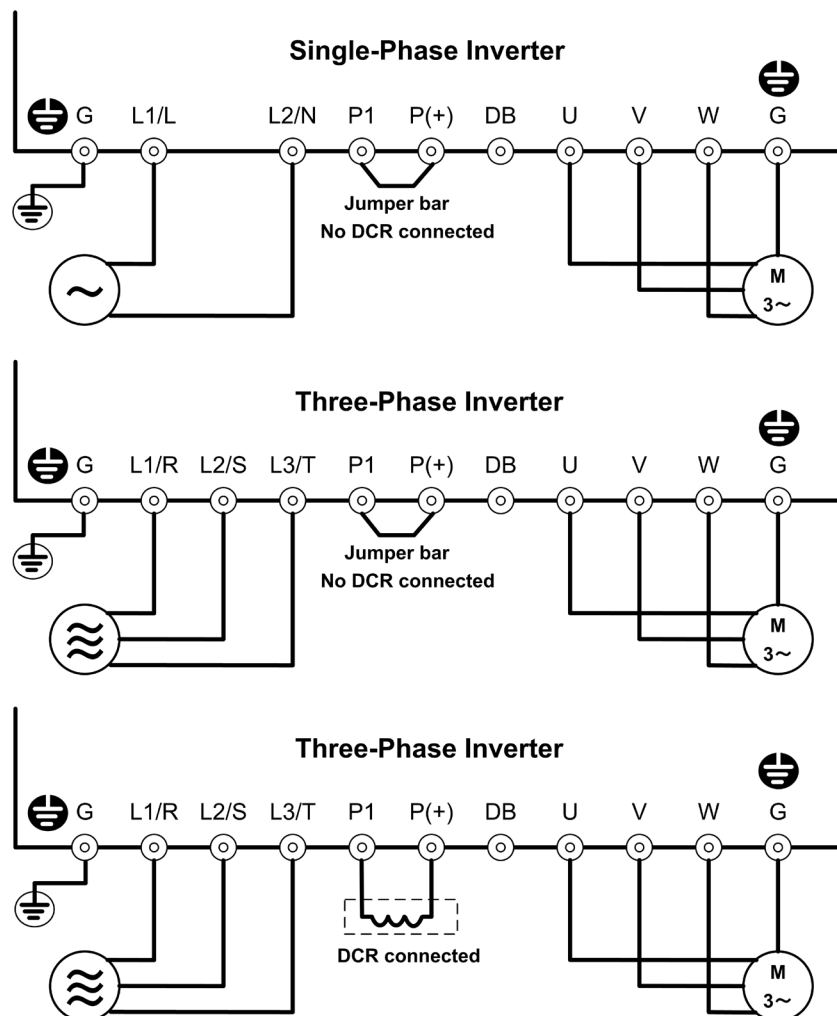

Figure 4.2-1 Connection of Main Circuit Terminals

4.3 Powering ON and Checking

⚠ WARNING

- Be sure to mount the front cover before turning the power ON. Do not remove the cover when the inverter power is ON.
- Do not operate switches with wet hands.

Otherwise, an electric shock could occur.

Turn the power ON and check the following points. The following is a case when no function code data is changed from the factory defaults.

- (1) Check that the LED monitor displays *8.8.8.8* (indicating that the destination is not set) that is blinking. See Figure 4.3-1.
- (2) Check that the inverter (built-in) cooling fans rotate.



Figure 4.3-1 Display of the LED Monitor after Power-on

4.4 Destination setting

For inverter type FRN****E2S/E2E-2G□/4G□/7G□ (FRENIC-Ace Global Model), the destination must be set first after the initial power supply. Without setting the destination, the function code cannot be changed. The inverter cannot be operated either. By setting the destination, basic function codes such as rated voltage, rated frequency, etc. are initialized to general values in each region (Table 4.4-1). If the destination value setting is changed after the initial destination setting, it can be changed with *B.d.E.S.* in the program mode menu or function code H101. If the destination is reset by *B.d.E.S.*, all function codes are initialized to the factory defaults. If the destination is set by H101, only the function codes in Table 4.4-1 are initialized to the values in Table 4.4-1. The destination can be selected from the regions of Japan, Asia, China, Europe, Americas and Korea.

If the function code set including the destination setting function code (H101) is copied with the data copy function or the FRENIC loader, manual destination setting is not required.

Set the initial destination as shown below. Refer to Figure 4.4-1 on the page 4-5.





- (1) With *B.d.E.S.* displayed, press  key first.
- (2) *AS* or *A* (Asian region) is displayed first. For other regions, while pressing  key and press  key or  key to select the destination.
- (3) After selecting the destination, *SPUE* is displayed by pressing  key and the destination setting is completed. Then, *0. 00* is displayed.

Table 4.4-1 Initial value for each destination

Destination	Asia	China	Europe	Americas	Korea	Japan
LED display	asia	chn	eU	amer	kor	jpn
H101:Destination	2	3	4	5	7	1
F03:Maximum output frequency 1	60.0Hz (200V)	50.0Hz	50.0Hz	60.0Hz	60.0Hz	60.0Hz
F04:Base frequency 1	50.0Hz (400V)					50.0Hz
F05:Rated voltage at base frequency 1	220/415V	200/380V	200/400V	230/460V	220/380V	200/400V
F06:Maximum output voltage 1						
F14:Restart mode after momentary power failure (Mode selection)	1	1	0	0	1	1
F44:Current limiter (Level)	130%	130%	130%	130%	130%	180/160%
E31:Frequency detection 1 (Level)	60.0Hz (200V) 50.0Hz (400V)	50.0Hz	50.0Hz	60.0Hz	60.0Hz	60.0Hz
E36:Frequency detection 2 (Level)						50.0Hz
E54:Frequency detection 3 (Level)						
P99:Motor 1 selection	0	0	0	1	0	0
H96:STOP key priority/ Start check function	0	0	0	3	0	0
A01:Maximum output frequency 2	60.0Hz (200V)	50.0Hz	50.0Hz	60.0Hz	60.0Hz	60.0Hz
A02:Base frequency 2	50.0Hz (400V)					50.0Hz
A03:Rated voltage at base frequency 2	220/415V	200/380V	200/400V	230/460V	220/380V	200/400V
A04:Maximum output voltage 2						
A39:Motor 2 selection	0	0	0	1	0	0
K01:Multifunction keypad TP-A1 (Language selection)	1	6	1	1	1	0

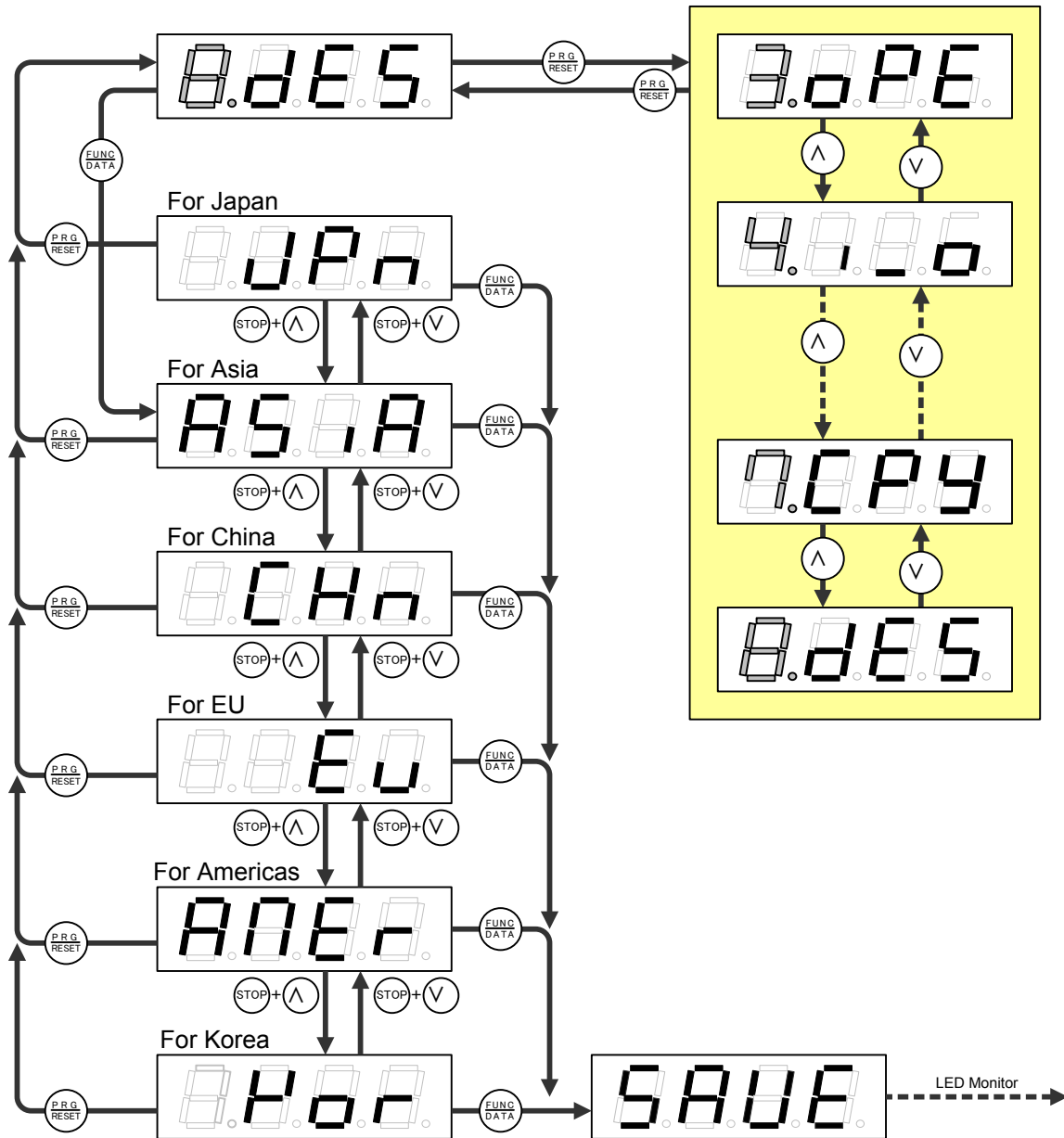

Figure 4.4-1 Destination setting status transition chart

4.5 Switching the Applicable Motor Rating (ND, HD, HND and HHD Modes)

Changing the data of function code F80 switches the applicable motor rank to match load conditions. In HD, HND or HHD mode, the inverter drives a motor whose capacity is one or two ranks lower than the inverter's one.

F80 data	Drive mode	Application	Applicable motor	Overload capability	Maximum frequency	Operating temperature	Application samples
4	ND mode	General load	Motor whose capacity is the same as the inverter's one.	120% for 1 min.	120 Hz	40°C (104°F)	Fan, pump, blower, compressor, etc.
3	HD mode	Heavy duty load	Motor whose capacity is one rank lower than the inverter's one.	150% for 1 min.	500 Hz	40°C (104°F)	Wire drawing machine, winding machine, twisting machine, spinning frame, etc.
1	HND mode	General load	Motor whose capacity is one rank lower than the inverter's one.	120% for 1 min.	500 Hz	50°C (122°F)	Fan, pump, blower, compressor, etc.
0	HHD mode	Heavy duty load	Motor whose capacity is two ranks lower than the inverter's one.	150% for 1 min. 200% for 0.5 s.	500 Hz	50°C (122°F)	Wire drawing machine, winding machine, twisting machine, spinning frame, hoist, machine tool, etc.

The HD-/HND-/HHD-mode inverter brings out the continuous rated current level which enables the inverter to drive a motor with one or two ranks lower capacity, but its overload capability (%) against the continuous current level or the operating temperature increases. For details, see Chapter 12 "SPECIFICATIONS."

Three-phase 400V series inverters have an ND/HD/HND/HHD four type rating. However, the FRN0007E2■-4□ and FRN0012E2■-4□ have an ND/HD/HHD three type rating.

Three-phase 200V series inverters have an HND/HHD two type rating. However, the FRN0012E2■-2□ and FRN0020E2■-2□ have an ND/HND two type rating.

Single-phase 200V series inverters have only an HHD single rating.

4.5 Switching the Applicable Motor Rating (ND, HD, HND and HHD Modes)

The inverter is subject to restrictions on the function code data setting range and internal processing as listed below.

Function codes	Name	ND mode	HD mode	HND mode	HHD mode	Remarks
F21*	DC braking (Braking level)	Setting range: 0 to 60%	Setting range: 0 to 80%		Setting range: 0 to 100%	
F26	Motor sound (Carrier frequency)	ND mode - 0.75 to 10 kHz (FRN0002E2■-4□ to FRN0059E2■-4□) - 0.75 to 10 kHz (FRN0012E2■-2□ to FRN0020E2■-2□) - 0.75 to 6 kHz (FRN0072E2■-4□ or above) HD/HND mode - 0.75 to 16 kHz (FRN0001E2■-2□ to FRN0088E2■-2□) - 0.75 to 16 kHz (FRN0002E2■-4□ to FRN0059E2■-4□) - 0.75 to 10 kHz (FRN0072E2■-4□ to FRN0168E2■-4□) - 0.75 to 10 kHz (FRN0115E2■-2□) - 0.75 to 6 kHz (FRN0203E2■-4□ or above) HHD mode - 0.75 to 16 kHz (FRN0001E2■-2□ to FRN0115E2■-2□) - 0.75 to 16 kHz (FRN0001E2■-7□ to FRN0011E2■-7□) - 0.75 to 16 kHz (FRN0002E2■-4□ to FRN0168E2■-4□) - 0.75 to 10 kHz (FRN0203E2■-4□ or above)				In the ND/HD/HND mode, a value out of the range, if specified, automatically changes to the maximum value allowable in the ND/HD/HND mode.
F44	Current limiter (Level)	Initial value: 130%	Initial value: 160%	Initial value: 130%	Initial value: FRN0088E2■-2□/ FRN0059E2■-4□ or above : 160% FRN0069E2■-2□/ FRN0044E2■-4□ or below : 180%	Switching the drive mode with function code F80 automatically initializes the F44 data to the value specified at left.
F03*	Maximum frequency	Setting range: 25 to 500 Hz Upper limit: 120 Hz	Setting range: 25 to 500 Hz Upper limit: 500 Hz			In the ND mode, if the maximum frequency exceeds 120 Hz, the actual output frequency is internally limited to 120 Hz.
—	Current indication and output	Based on the rated current level for ND mode	Based on the rated current level for HD mode	Based on the rated current level for HND mode	Based on the rated current level for HHD mode	—

Switching between the drive modes does not automatically change the motor rated capacity (P02*) to the one suitable for the rank-changed motor, so configure the P02* data to match the applied motor rating as required.

4.6 Selecting a Desired Motor Drive Control

The FRENIC-Ace supports the following motor drive control.

F42* data	Drive control	Basic control	Applicable Motor type	Speed feedback	Speed control	For configuration, refer to:
0	V/f control with slip compensation inactive	V/f control	IM	Disable	Frequency control	4.8.1 [1] 4.8.1 [2]
1	Vector control without speed sensor (Dynamic torque vector)				Frequency control with slip compensation	
2	V/f control with slip compensation active				Enable	Frequency control with ASR (Auto speed regulator)
3	V/f Control with speed sensor					
4	V/f Control with speed sensor (with Auto Torque Boost)					
6	Vector Control with speed sensor	Vector control	PM	Estimated Speed	Speed control with automatic speed regulator (ASR)	4.8.1 [4]
15	Vector Control without speed sensor and magnetic pole position sensor				4.8.2 [1] 4.8.2 [2] 4.8.2 [3]	

4.6.1 V/f control with slip compensation inactive for IM

Under this control, the inverter controls a motor with the voltage and frequency according to the V/f pattern specified by function codes. This control disables all automatically controlled features such as the slip compensation, so no unpredictable output fluctuation results, enabling stable operation with constant output frequency.

4.6.2 Vector control without speed sensor (Dynamic torque vector) for IM

To get the maximal torque out of a motor, this control calculates the motor torque for the load applied and uses it to optimize the voltage and current vector output.

Selecting this control automatically enables the auto torque boost and slip compensation function.

This control is effective for improving the system response to external disturbances such as load fluctuation, and the motor speed control accuracy.

Note that the inverter may not respond to a rapid load fluctuation since this control is an open-loop V/f control that does not perform the current control, unlike the vector control. The advantages of this control include larger maximum torque per output current than that the vector control.



Since slip compensation and vector control without speed sensor (dynamic torque vector) use motor parameters, the following conditions should be satisfied; otherwise, full control performance may not be obtained.

- A single motor should be controlled per inverter.
- Motor parameters P02*, P03*, and P06* to P13* should be properly configured or auto-tuning (P04*) should be performed.
- The capacity of the motor to be controlled should not be two or more ranks lower (based on the HHD mode) than that of the inverter under the vector control without speed sensor (dynamic torque vector). Otherwise, the inverter may not control the motor due to decrease of the current detection resolution. The wiring distance between the inverter and motor should be 50 m (164 ft) or less. If it is longer, the inverter may not control the motor due to leakage current flowing through stray capacitance to the ground or between wires. Especially, small capacity inverters whose rated current is also small may be unable to control the motor correctly even when the wiring is less than 50 m (164 ft). In that case, make the wiring length as short as possible or use a wire with small stray capacitance (e.g., loosely-bundled cable) to minimize the stray capacitance.

4.6.3 V/f control with slip compensation active for IM

Applying any load to an induction motor causes a rotational slip due to the motor characteristics, decreasing the motor rotation. The inverter's slip compensation function first presumes the slip value of the motor based on the motor torque generated and raises the output frequency to compensate for the decrease in motor rotation. This prevents the motor from decreasing the rotation due to the slip.

That is, this function is effective for improving the motor speed control accuracy.

The compensation value is specified by combination of function codes P12* (Rated slip frequency), P09* (Slip compensation gain for driving) and P11* (Slip compensation gain for braking).

H68* enables or disables the slip compensation function according to the motor driving conditions.

H68* data	Motor driving conditions		Motor driving frequency zone	
	Accl/Decel	Constant speed	Base frequency or below	Above the base frequency
0	Enable	Enable	Enable	Enable
1	Disable	Enable	Enable	Enable
2	Enable	Enable	Enable	Disable
3	Disable	Enable	Enable	Disable

4.6.4 V/f Control with speed sensor for IM

This control requires an optional PG (pulse generator) and an optional PG interface card to be mounted on a motor shaft and on the inverter, respectively. Applying any load to an induction motor causes a rotational slip due to the motor characteristics, decreasing the motor rotation.

Under V/f control with speed sensor, the inverter detects the motor rotation using the encoder mounted on the motor shaft and compensates for the decrease in slip frequency by the PI control to match the motor rotation with the commanded speed. This improves the motor speed control accuracy.

4.6.5 V/f Control with speed sensor with Auto Torque Boost for IM

The difference from the "V/f control with speed sensor" stated above is that this method calculates the motor torque for the load applied and uses the calculated torque to optimize the output voltage and current vectors for getting the maximal torque out of a motor.

This control is effective for improving the system response to external disturbances such as load fluctuations, and for improving the motor speed control accuracy.

4.6.6 Vector Control with speed sensor for IM

This control requires an optional PG (pulse generator) and an optional PG interface card to be mounted on a motor shaft and on the inverter, respectively. The inverter detects the motor's rotational position and speed from PG feedback signals and uses them in the control. In addition, it decomposes the motor drive current into the exciting and torque current components, and controls each of components in vector.

The desired response can be obtained by adjusting the control constants (PI constants) and using the speed regulator (PI controller). This control enables the speed control with higher accuracy and quicker response than the vector control without speed sensor.

-  Note
- Since vector control with speed sensor use motor parameters, the following conditions should be satisfied; otherwise, full control performance may not be obtained.
 - A single motor should be controlled per inverter.
 - Motor parameters P02*, P03*, P06* to P13*, P16* to P20*, P53*, P55* and P56* should be properly configured or auto-tuning (P04*) should be performed.
 - The capacity of the motor to be controlled should not be two or more ranks lower than that of the inverter under vector control with speed sensor; it should be the same as that of the inverter under the vector control with speed sensor. Otherwise, the inverter may not control the motor due to decrease of the current detection resolution.
 - The wiring distance between the inverter and motor should be 50 m or less. If it is longer, the inverter may not control the motor due to leakage current flowing through stray capacitance to the ground or between wires. Especially, small capacity inverters whose rated current is also small may be unable to control the motor correctly even when the wiring is less than 50 m. In that case, make the wiring length as short as possible or use a wire with small stray capacitance (e.g., loosely-bundled cable) to minimize the stray capacitance.

4.6.7 Vector Control without speed sensor and magnetic pole position sensor for PMSM

This control estimates the motor speed based on the inverter's output voltage and current to use the estimated speed for speed control. In addition, it decomposes the motor drive current into the exciting and torque current components, and controls each of those components in vector. No PG (pulse generator) interface card is required. It is possible to obtain the desired response by adjusting the control constants (PI constants) using the speed regulator (PI controller).

 Note Since "Vector control for PMSM without speed sensor and magnetic pole position sensor" uses motor parameters, the following conditions should be satisfied; otherwise, full control performance may not be obtained.

- A single motor should be controlled per inverter.
- Motor parameters P02, P03, P30 and P60 to P63 should be properly configured. Or, auto-tuning (P04) should be performed.
- In the HHD mode, the capacity of the motor to be controlled should be the same as that of the inverter; otherwise, the inverter may not control the motor due to decrease of the current detection resolution. In the HND, HD and ND modes, the inverter can drive the motor that is 1 or 2 ranks higher than the inverter.
- The wiring distance between the inverter and motor should be 100 m (328 ft) or less. If it is longer, the inverter may not control the motor due to leakage current flowing through stray capacitance to the ground or between wires. Especially, small capacity inverters whose rated current is also small may be unable to control the motor correctly even when the wiring is less than 100 m (328 ft). In that case, make the wiring length as short as possible or use a wire with small stray capacitance (e.g., loosely-bundled cable) to minimize the stray capacitance.
- To use the inverter with the output frequency exceeding 500 Hz (in case of ND mode, up to 120 Hz), it is recommended that the carrier frequency (F26) be set to 4 kHz or higher.
- Do not use it outside of the speed control range (1:10).

4.7 Performance Comparison for Drive Controls (Summary)

Each drive control has advantages and disadvantages. Table 4.7-1 compares the different drive controls, showing their relative performance in each characteristic.

Select the one that shows high performance in the characteristics that are important in your machine. In rare cases, the performance shown below may not be obtained due to various conditions including motor characteristics or mechanical rigidity. The final performance should be determined by adjusting the speed control system or other elements with the inverter being connected to the machine (load). If you have any questions, contact your Fuji Electric representative.

Table 4.7-1

F42* data	Drive control	Output frequency stability	Speed control accuracy	Speed control response	Maximum torque	Load disturbance	Current control	Torque accuracy
0	V/f control with slip compensation inactive	A	—	—	A	—	—	C
1	Vector control without speed sensor (Dynamic torque vector)	C	C	C	A	C	—	B
2	V/f control with slip compensation active	C	D	D	A	C	—	C
3	V/f Control with speed sensor	C	A	B	A	C	—	C
4	V/f Control with speed sensor (with Auto Torque Boost)	C	A	B	A	C	—	A
6	Vector Control with speed sensor	C	A	A	B	A	A	A
15	Vector Control without speed sensor and magnetic pole position sensor	C	A	B	B	B	A	A

Relative performance symbols A: Excellent, B: Good, C: Effective, D: Less effective, —: Not effective

4.8 Configuring Function Codes for Drive Controls

The relation of the motor control method, motor selection and motor parameter setting is shown in Figure 4.8-1. It is necessary to change the motor parameter setting depending on the driven motor.

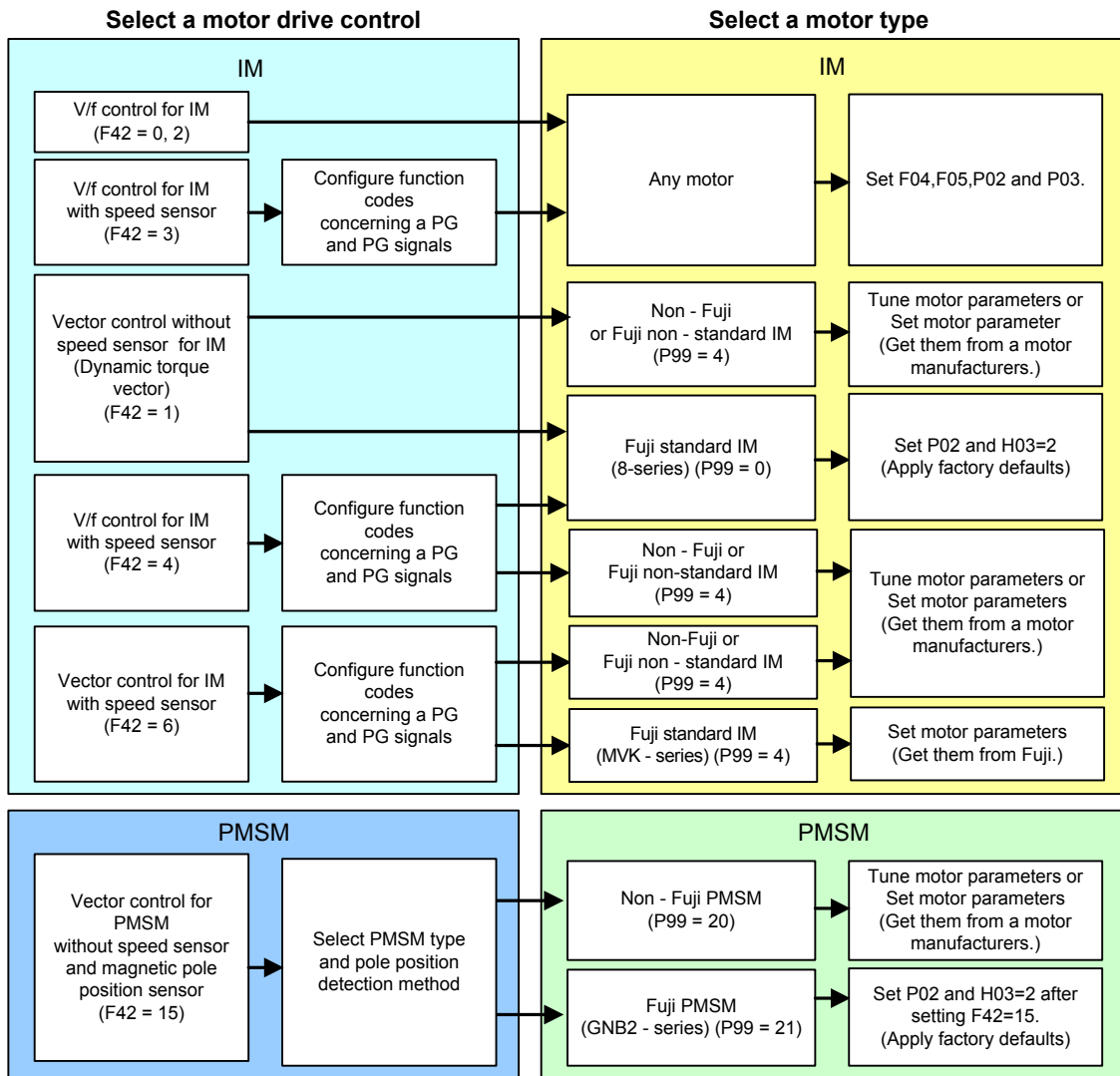

Figure 4.8-1

- Note** Factory defaults are set to drive the induction motor with V/f control. (F42 = 0)
The motor can not be driven properly if the synchronous motor is connected.
If the synchronous motor is driven, it is necessary to set F42=15 to change the drive control mode for driving the synchronous motor.
It is also necessary to set the motor parameters for the synchronous motor. Refer to “4.6.7 Vector Control without speed sensor and magnetic pole position sensor for PMSM” for the explanation of the test run of the synchronous motor.
- Note** If F42 is changed to any other value from 15 or vice versa, setting related to motor parameters such as F04, F05, P01, etc... will be changed. In this case, re-configuration is required. For details, refer to Chapter 5 “5.3.4 P codes (Motor 1 parameters)”.
- Tip** The test run seems to be better to be executed under speed control (H18=0) temporarily even if torque control is required. It is recommended to change to torque control (H18 = 2 or 3) after checking that the operation is normal in the test run.

4.8.1 Driving an Induction Motor (IM)

[1] Driving a non-Fuji motor or Fuji non-standard IM under the V/f control

(1) Configuring the function codes of motor parameters

Under the V/f control (F42* = 0 or 2), any of the following cases requires configuring the basic function codes given below and auto-tuning.

- Driving a non-Fuji motor or non-standard motor.
- Driving a Fuji general-purpose motor, provided that the wiring distance between the inverter and motor is long or a reactor is connected.

Configure the function codes listed below according to the motor ratings and design values of the machine. For the motor ratings, check the ratings printed on the motor's nameplate. For design values of the machine, ask system integrators or machine manufacturers about them.

 For details on how to modify the function code data, see Chapter 3 "3.4.1 Setting up function codes "Data Setting: *iF_* through *iD_*."

Function code	Name	Function code data
<i>F 04</i> *	Base frequency 1	Motor ratings (printed on the nameplate of the motor)
<i>F 05</i> *	Rated voltage at base frequency 1	
<i>P 02</i> *	Motor 1 (Rated capacity)	
<i>P 03</i> *	Motor 1 (Rated current)	
<i>P 99</i> *	Motor 1 selection	4: Other motors (Select "1" for HP rating motors)
<i>F 03</i> *	Maximum frequency 1	Machine design values (Note) For the test run of the motor, increase values so that they are longer than your machine design values. If the specified time is short, the inverter may not run the motor properly.
<i>F 07</i>	Acceleration time 1 (Note)	
<i>F 08</i>	Deceleration time 1 (Note)	

 **Note** When accessing the function code P02*, take into account that changing the P02* data automatically updates the data of the function codes P03*, P06* to P13*, P16* to P20*, P53*, P55*, P56*, and H46.

[2] Driving a Fuji general-purpose IM under the V/f control

(1) Configuring the function codes of motor parameters

Driving a Fuji general-purpose motor under the V/f control (F42* = 0 or 2) or vector control without speed sensor (dynamic torque vector, F42* = 1) requires configuring the following basic function codes.

Select Fuji standard 8-series motors with the function code P99*.

Configure the function codes listed below according to the motor ratings and design values of the machine. For the motor ratings, check the ratings printed on the motor's nameplate. For design values of the machine, ask system integrators or machine manufacturers about them.

 For details on how to modify the function code data, see Chapter 3 "3.4.1 Setting up function codes "Data Setting: *iF_* through *iD_*."

Function code	Name	Function code data
<i>F 04*</i>	Base frequency 1	Motor ratings (printed on the nameplate of the motor)
<i>F 05*</i>	Rated voltage at base frequency 1	
<i>P 99*</i>	Motor 1 selection	Motor characteristics 0 (Fuji standard motors, 8-series)
<i>P 02*</i>	Motor 1 (Rated capacity)	Applicable motor capacity
<i>F 03*</i>	Maximum frequency 1	Machine design values (Note) For the test run of the motor, increase values so that they are longer than your machine design values. If the specified time is short, the inverter may not run the motor properly.
<i>F 07</i>	Acceleration time 1 (Note)	
<i>F 08</i>	Deceleration time 1 (Note)	

After the above configuration, initialize motor 1 with the function code (H03 = 2). It automatically updates the motor parameters P01*, P03*, P06* to P13*, P16* to P20*, P53*, P55*, P56*, and H46.

 **Note** When accessing the function code P02*, take into account that changing the P02* data automatically updates the data of the function codes P03*, P06* to P13*, P16* to P20*, P53*, P55*, P56*, and H46.

The motor rating should be specified properly when performing auto-torque boost, torque calculation monitoring, auto energy saving, torque limiting, automatic deceleration (anti-regenerative control), auto search for idling motor speed, slip compensation, torque vector control, droop control, or overload stop.

In any of the following cases, the full control performance may not be obtained from the inverter because the motor parameters differ from the factory defaults, so perform auto-tuning. (Refer to 0(3) Tuning (For IM).)

- The driven motor is a non-Fuji or a Fuji non-standard one.
- The wiring distance between the inverter and the motor is too long (generally 20 m or more).
- A reactor is installed between the inverter and the motor.

[3] Driving an IM under the V/f control with speed sensor

(1) Configuring the function codes of motor parameters

For details, refer to “4.8.1 [1] Driving a non-Fuji motor or Fuji non-standard IM under the V/f control.” In addition, if you use the V/f control with speed sensor, you must set P01:the number of poles.

(2) Configuring the function codes concerning a PG (pulse generator) and PG signals

If “V/f control with speed sensor (F42*=3)”, “V/f control with speed sensor and auto torque boost (F42*=4)” or “Vector control with speed sensor (F42*=6)” is used, setting of the following function codes is necessary to receive the rotation direction and speed detection signal from the speed sensor correctly.

 For details on how to modify the function code data, see Chapter 3 “3.4.1 Setting up function codes “Data Setting: *iF_* through *iD_*.””

Function code	Name	Function code data
d 14	Feedback input (Pulse input format)	Pulse input format of motor encoder to be controlled 2: Quadrature A/B signal(B phase lead) 3: Quadrature A/B signal(A phase lead) * The relation between the motor forward rotation and encoder forward rotation direction is shown in Figure 4.8-2.
d 15	Feedback input (Encoder pulse resolution)	Set “Pulse number of the target motor encoder” in hexadecimal notation.(Displayed in decimal notation on the multi function keypad) e.g. 0400 hex. Or 1024 P/R
d 16	Feedback input (Pulse scaling factor 1)	Reduction ratio between the motor and the encoder Motor speed =Encoder speed × (d17) / (d16)
d 17	Feedback input (Pulse scaling factor 2)	These functions are set if the encoder is mounted on the speed changer/reducer side. If it is directly connected to the motor shaft, the factory default value “1” does not need to be changed.

 **Note** If the rotation direction/speed detection signal from the encoder does not match with the motor rotation direction, excessive current is applied.

In the case of the vector control with speed sensor (F42*=6), the motor does not reach the set frequency but rotates slowly at the speed equivalent to the slip frequency. In this case, check that the phase order of motor wires is correct and the encoder wires are correctly connected and are not broken.

 **Tip** In 4_17 to 4_18 of I/O check, the number of feedback pulses per second of AB phase and Z phase can be checked. In 3_29 of the drive monitor, the frequency [Hz] calculated from the speed detection signal from the encoder can be checked. These are displayed regardless of the control method if the PG option card is mounted and the encoder is wired.

It is recommended to check that the rotation direction and speed are correctly detected by rotating the motor manually or executing tentative operation by “V/f control (F42*=0)” at first. After that, switch the desired control method.

Fuji regards the CCW as the forward rotation direction viewed from the motor output shaft as shown in Figure 4.8-2.

During rotation in the forward direction, the PG output pulse forms a forward rotation signal (B phase leads by 90 degrees) as shown in Figure 4.8-2, and during rotation in the reverse direction, a reverse rotation signal (A phase leads by 90 degrees).

In the case of motors other than non-Fuji one, for example, to mount an external PG, directly connected it to the motor, using a coupling, etc.

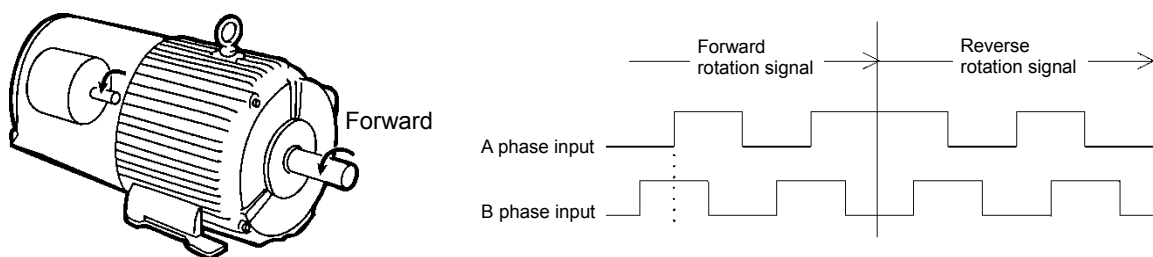

Figure 4.8-2 Forward Rotational Direction of Motor and PG (Pulse Generator)

 **Note** In the case of using motors which comply with IEC standard, their rotation directions are opposite to that in Figure 4.8-2.

[4] Driving a non-Fuji motor or Fuji non-dedicated IM under vector control with/without speed sensor

(1) Configuring the function codes of motor parameters

When “driving under vector control with speed sensor (F42* = 6)” or “vector control without speed sensor (dynamic torque vector, F42* = 1)”, it is necessary to set the motor parameters.

Execute auto tuning when driving non-Fuji or Fuji non-dedicated vector motor (non-VG motor) under “vector control (F42*=6) with speed sensor” or any motor under “vector control without speed sensor (dynamic torque vector) (F42* = 1)”.

Configure the function codes listed below according to the motor ratings and design values of the machine. For the motor ratings, check the ratings printed on the motor's nameplate. For design values of the machine, ask system integrators or machine manufacturers about them.

Execute auto tuning after setting values and initializing the motor (H03=2).

 For details on how to modify the function code data, see Chapter 3 “3.4.1 Setting up function codes “Data Setting: iF_{-} through iO_{-} .”

Function code	Name	Function code data
P 99*	Motor 1 selection	4: Other motors
F 04*	Base frequency 1	Motor rated value (printed on motor rating nameplate) If the motor synchronous rotation speed (min^{-1}) is identified, calculate F05 by the following formula and set it. $\frac{\text{Synchronous rotation speed}}{120} \times \text{Number of poles}$
F 05*	Rated voltage at base frequency 1	
P 01*	Motor 1 (No. of poles)	
P 02*	Motor 1 (Rated capacity)	
P 03*	Motor 1 (Rated current)	
P 06*	Motor 1 (No-load current)	In case of difficult to execute rotation tuning: Set the value in the motor test report or the value calculated by the following formula. $\sqrt{(P03)^2 - (P55)^2}$ If rotation tuning is possible: By tuning
F 03*	Maximum frequency 1	Design specification
F 07	Acceleration time 1 (Note)	Note For the test run of the motor, increase values so that they are longer than your machine design values. If the specified time is short, the inverter may not run the motor properly.
F 08	Deceleration time 1 (Note)	

 When accessing the function code P02*, take into account that changing the P02* data automatically updates the data of the function codes P03*, P06* to P13*, P16* to P20*, P53*, P55*, and H46.

- If the motor is used under vector control with speed sensor, it is recommended to use the dedicated motor whose rated voltage is designed to be lower than the power voltage.
- If the general-purpose motor is used under vector control, the rated voltage (base frequency voltage) becomes equal to the input voltage and there is no voltage margin to control with vector control. This might increase the motor current exceeding the rating current and might occur the motor overheat or overload trip.

 After the above configuration, initialize motor 1 with the function code (H03 = 2). It automatically updates the motor parameters P01*, P03*, P06* to P13*, P16* to P20*, P53*, P55*, and H46.

(2) Configuring the function codes concerning a PG (pulse generator) and PG signals

For details, refer to “4.8.1 [3] (2) Configuring the function codes concerning a PG (pulse generator) and PG signals”

(3) Tuning (For IM)

■ Selection of tuning type

Check the situation of the machine and select “Tuning with the motor stopped (P04* = 1)” or “Tuning with the motor running (P04* = 2).” For the latter tuning, adjust the acceleration and deceleration times (F07 and F08) and specify the rotation direction that matches the actual rotation direction of the machine.

 **Note** If tuning (P04* = 2) with motor running cannot be selected due to the machine, refer to “**■ Countermeasures when tuning for motor rotation cannot be executed**”.

P04* data	Tuning type	Motor parameters subjected to tuning	Tuning	Select under the following conditions
1	Tune while the motor stops.	Primary resistance (%R1) (P07*) Leakage reactance (%X) (P08*) Rated slip frequency (P12*) %X correction factor 1 (P53*)	Tuning with <u>the motor stopped</u> .	Cannot rotate the motor.
2	Tune while the motor is rotating	No-load current (P06*) Primary resistance (%R1) (P07*) Leakage reactance (%X) (P08*) Rated slip frequency (P12*) %X correction factor 1 (P53*) magnetic saturation factor 1 to 5 (P16* to P20*)	Tuning the %R1 and %X, <u>with the motor stopped</u> . Tuning the no-load current and magnetic saturation factor, <u>with the motor running</u> at 50% of the base frequency. Tuning again the rated slip frequency, <u>with the motor stopped</u> . <u>(For vector control, tuning is executed twice)</u>	Can rotate the motor, provided that it is safe. Note that little load should be applied during tuning. Tuning with load applied decreases the tuning accuracy.
5	Tune while the motor stops.	Primary resistance (%R1) (P07*) Leakage reactance (%X) (P08*) %X correction factor 1 (P53*)	Tuning <u>with the motor stopped</u> .	Cannot rotate the motor.



The tuning results of motor parameters will be automatically stored into their respective function codes. If tuning by P04* is performed, the tuning results will be stored into P* codes (Motor 1* parameters).

 **Note** In the case of tuning by A18*, the tuning data is set to the function code (A* code) of motor 2*.

■ Preparation of machine

In preparation for tuning, remove the motor coupling with the load and deactivate the safety devices before rotation tuning.

■ Tuning procedure

- 1) Set function code P04* to "1" or "2" and press the  key. (The blinking of / or \overline{E} on the LED monitor will slow down.)
- 2) Enter a run command. The factory default is " key on the keypad for forward rotation." To switch to reverse rotation or to select the terminal signal **FWD** or **REV** as a run command, change the data of function code F02.
- 3) The moment a run command is entered, the display of / or \overline{E} lights up, and tuning starts with the motor stopped. (Maximum tuning time: Approx. 40 to 80 s.)
- 4) If P04* = 2, after the tuning in "3)" above, the motor is accelerated to approximately 50% of the base frequency and then tuning starts. Upon completion of measurements, the motor decelerates to a stop. (Estimated tuning time: Acceleration time + 20 to 75 s + Deceleration time)
- 5) If P04* = 2, after the motor decelerates to a stop in "4)" above, tuning continues with the motor stopped. (Maximum tuning time: Approx. 40 to 80 s.)
- 6) (Execute if function code P04* = 2 and under vector control)
Accelerate up to about 50% of the base frequency again and start tuning. After measurement, the motor decelerates to stop. (Approximate tuning time: Acceleration time + 20 to 160 seconds + Deceleration time)
- 7) (Execute if function code P04* = 2 and for vector control)
After deceleration and stop, continue tuning in a stopped state. (Tuning time: Approx. 20 to 30 s max.)
- 8) If the terminal signal **FWD** or **REV** is selected as a run command (F02 = 1), \overline{E} appears upon completion of the measurements. Turning the run command OFF completes the tuning.
If the run command has been given through the keypad or the communications link, it automatically turns OFF upon completion of the measurements, which completes the tuning.
- 9) Upon completion of the tuning, the subsequent function code appears on the keypad.

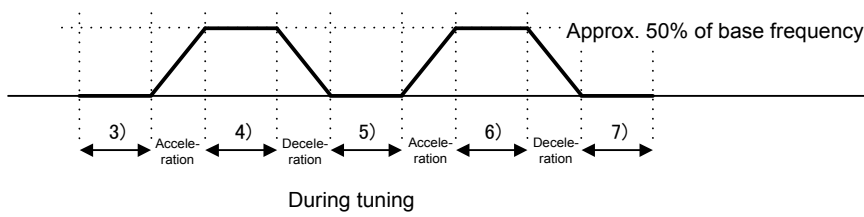

 **Note** Initial setting of the speed regulator is rather low to prevent hunting. Hunting or tuning error (\overline{E} 7) may occur depending on the mechanical conditions. If such problems occur, lower the gain of the speed control system. If speed mismatch or excessive speed deviation (\overline{E} 7) occurs, increase the gain or cancel PG error processing (d23 = 0) and execute tuning again.

■ Countermeasures when tuning for motor rotation cannot be executed

If “rotation tuning (P04* = 2)” cannot be executed due to the machine, execute “stop tuning (P04* = 1)” by the following procedure. Compared to “rotation tuning”, characteristics including the speed control accuracy and stability might be inferior. Execute the connection test with the machine completely.

1) In the case of Fuji non-standard induction motor:

- ① Set the function code P99* to “4” depending on the motor type.
- ② Initialize the motor 1 by function code H03. (H03 = 2)
- ③ Set function codes F04*, F05*, P02*, and P03* depending on the rated values of the motor.
- ④ Execute “stop tuning (P04* = 1)”.

2) In case of the motors whose parameters are unknown or manufactured by other manufacturers: (Stop tuning)

- ① Set function codes F04*, F05*, P02*, and P03* depending on the ratings nameplate of the motor.
- ② Set the motor constant (P06*) from the test report of the motor.
Consult Fuji Electric for details of conversion from the test report to various data.
- ③ Execute “stop tuning (P04* = 1)”.

3) In case of the motors whose parameters are unknown or manufactured by other manufacturers: (Manual setting)

- ① Set the function code P99* to “4” depending on the motor type.
- ② Initialize motor 1 by function code H03. (H03 = 2)
- ③ Set each function code based on Table 4.8-1.
Consult Fuji Electric us for details of conversion to various data.

Table 4.8-1

Function code	Name	Function code data
P 99 0.	Motor 1 selection	4: Other motors
F 04 0.	Base frequency 1	Motor ratings (printed on the nameplate of the motor) If the motor synchronous speed is known, calculate F05 by the following formula and set it. $\frac{\text{Synchronous rotation speed}}{120} \times \text{Number of poles}$
F 05 0.	Rated voltage at base frequency 1	
P 01*	Motor 1 (No. of poles)	
P 02*	Motor 1 (Rated capacity)	
P 03*	Motor 1 (Rated current)	
P 06*	Motor 1 (No-load current)	Set the value described in motor test report, or $\sqrt{(P03)^2 - (P55)^2}$
P 07*	Motor 1 (%R1)	Calculated from value described in motor test report. Refer to Chapter 5 “5.3.4 P codes (Motor 1 parameters)”.
P 08*	Motor 1 (%X)	Calculated from value described in motor test report. Refer to Chapter 5 “5.3.4 P codes (Motor 1 parameters)”.
P 12*	Motor 1 (rated slip frequency)	Set the value multiplying 0.7 by the value described in motor test report, or, if the motor rated speed is known, set the value multiplying by 0.7 the value calculated by the following formula: $\frac{\text{Synchronous rotation speed} - \text{Rated rotation speed}}{\text{Synchronous rotation speed}} \times \text{Base frequency 1}$
P 13*	Motor 1 (Iron loss)	Set “Value described in motor test report / Motor rated capacity” P 02. If the value is unknown, set 0%.
P 16* to P 20*	Motor 1 (Magnetic saturation factors 1 to 5)	Set P16=93.8%, P17=87.5%, P18=75.0%, P19=62.5%, P20=50.0%.
P 53*	Motor 1 (%X correction factor 1)	Set 100%.
F 03*	Maximum frequency 1	Machine design values
F 07	Acceleration time 1 (Note)	(Note) For the test run of the motor, increase values so that they are longer than your machine design values. If the specified time is short, the inverter may not run the motor properly.
F 08	Deceleration time 1 (Note)	

■ Tuning errors (For IM)

If the inverter finds any abnormality in the tuning results or any error in the tuning process, it displays E_r 7 and discards the tuning data.

When the tuning error (E_r 7) appears, check that:

- The inverter's output (secondary) circuit is opened or not.
- The mechanical brake is applied or not.
- The terminal command **BX** ("Coast to a stop") is turned ON or not.
- Any function code is wrongly configured.

Listed below are possible causes that trigger tuning errors and measures.

Possible tuning error causes	E_r 7 error subcode	Details and Measures
Sequence error	7 8 9	Before completion of tuning, a run command has been turned OFF. Or during tuning, terminal command STOP ("Force to stop") or BX ("Coast to a stop") has been entered. → Do not stop the inverter running until completion of tuning.
Output current error	6 10	During tuning, an excessively large current has flown. → Release a mechanical brake or take any other measure to remove the cause resulting in overcurrent.
Error in tuning results	1 2 3 4	An interphase voltage unbalance or output phase loss has been detected. Tuning has resulted in an abnormally high or low value of a parameter due to the output circuit opened. → Check motor cable (disconnection, short circuit or grounded).
Tuning frequency error (only when P04=2)	13	The maximum frequency or the frequency limiter (high) has limited the output frequency. → Increase the F03 and F15 settings to values greater than 50% of the base frequency 1 (F04).
Occurrence of alarm	15	During tuning, any alarm has occurred. → Check the contents of the multiple alarm and remove the error cause. For details, refer to Chapter 6 "TROUBLESHOOTING."
Acceleration timeout (only when P04=2)	18	The output frequency has not reached 50% of the base frequency within the specified acceleration time "F07×300%". → Increase the F07 setting.

If any of these errors occurs, remove the error cause and perform tuning again, or consult your Fuji Electric representative.



If a filter other than the Fuji optional output filter (OFL-□□□-□A) is connected to the inverter's output (secondary) circuit, the tuning result cannot be assured. When replacing the inverter connected with such a filter, make a note of the old inverter's settings for the primary resistance %R1, leakage reactance %X, no-load current, and rated slip frequency, and specify those values to the new inverter's function codes.

Vibration that may occur when the motor's coupling is elastic can be regarded as normal vibration due to the output voltage pattern applied in tuning. The tuning does not always result in an error; however, run the motor and check its running state.

[5] Driving a Fuji dedicated IM (MVK series) under vector control with speed sensor

(1) Configuring the function codes of motor parameters

If the motor is driven under vector control with speed sensor (F42* = 6), it is necessary to set the motor parameters. If the dedicated motor for Fuji vector control (MVK series) is used, the motor parameters will be notified separately. After setting P99 = 4 and initializing by H03 = 2, set the notified parameters.

(2) Configuring the function codes concerning a PG (pulse generator) and PG signals

For details, refer to "4.8.1 [3] (2) Configuring the function codes concerning a PG (pulse generator) and PG signals."

4.8.2 Driving a permanent magnet synchronous motor (PMSM) without pole sensor and magnetic pole position sensor

■ Selection of PMSM type and pole position detection method

The permanent magnet type synchronous motor is classified as follows depending on the rotor structure (magnet layout):

- a) Surface magnet assembling magnet on rotor surface (SPM: Surface Permanent Magnet)
- b) Buried magnet assembling magnet into rotor iron core (IPM: Interior permanent magnet)

The starting magnetic pole position detection method depends on the motor type.

In most cases, the IPMPMs are generally used, but the SPMSMs are sometimes used. Consult with the motor manufacturer before use. Set the Initial magnetic position detection mode to the function code P30. (For details, refer to Chapter 5 “5.3.4 P codes (Motor 1 parameters).”)

If the motor type is unknown, set P30 = 0.

[1] Driving a non-Fuji PMSM

To drive other manufacturer's synchronous motor, set the motor parameters shown in Table 4.8-2 and execute offline tuning.

Check the motor parameters on the motor rating nameplate or consult with the motor manufacturer before setting them.



There is the case that the customer's order, the motor parameters have been set at the factory. Please note that you do data initialized using the H03, motor parameters will be lost. Before initialization, record the data to be changed to memorize the motor constant.

(1) Configuring the function codes of motor parameters

When driving PMSM without speed sensor and magnetic pole position sensor, set the motor parameters after selecting F42=15.

Configure the function codes listed Table 4.8-2 according to the motor ratings and design values of the machine. For the motor ratings, check the ratings printed on the motor's nameplate. For design values of the machine, ask system integrators or machine manufacturers about them.



For details on how to modify the function code data, see Chapter 3 “3.4.1 Setting up function codes “Data Setting: iF_{-} through iD_{-} .””

4.8 Configuring Function Codes for Drive Controls

Table 4.8-2 Motor parameters required for tuning and function code to be set (Synchronous motor)

Function code	Name	Function code data
<i>F 42</i>	Drive control selection 1	15: Vector control for synchronous motor without speed sensor and pole position sensor Note: Setting value "20" or "21" in P99 does not appeared if F42 is not set to "15".
<i>P 99*</i>	Motor 1 selection	20: Other motors (PMSMs)
<i>F 04</i>	Base frequency 1	Motor rated value (printed on motor rated nameplate or motor test report) If the motor rated speed is known, calculate F05 by the following formula and set it. Rated rotation speed (Rotational speed [r/m]) / (120 / Number of poles)
<i>F 05</i>	Rated voltage at base frequency 1	
<i>P 01</i>	Motor 1 (No. of poles)	
<i>P 02*</i>	Motor 1 (Rated capacity)	
<i>P 03*</i>	Motor 1 (Rated current)	
<i>P 30</i>	PMSM Motor 1 (Magnetic pole position detection mode)	Motor type and starting method If 0: Rotor structure (magnet layout) is unknown: 1,3: IPM 2: SPM
<i>P 63</i>	PMSM Motor 1 (Induced voltage)	Value described in motor test report If the value is unknown, execute rotation tuning.
<i>P 64</i>	PMSM Motor 1 (Iron loss)	Set "the iron loss described in motor test report divided by Motor rated capacity: <i>P 02</i> ". Set 0%, if the iron loss is unknown.
<i>P 90</i>	PMSM Motor 1 (Overcurrent protection level)	Demagnetization limit current of motor [A] (Effective value) Over current protection level [Arms] * This is used for protection from demagnetization by motor over current. Set this function code if it is known. If it is unknown, set approx. 200% of motor rated current.
<i>F 03*</i>	Maximum frequency 1	Design specification Note) For the test run of the motor, increase values so that they are longer than your machine design values. If the specified time is short, the inverter may not run the motor properly.
<i>F 15</i>	Frequency Limiter (Upper)	
<i>F 07</i>	Acceleration time 1 (Note)	
<i>F 08</i>	Deceleration time 1 (Note)	

(2) Tuning under vector control for PMSM without speed sensor and magnetic pole position sensor

■ Selection of PMSM type and pole position detection method

After identifying the type of the synchronous motor and selecting the magnetic pole position detection mode, execute tuning based on Figure 4.8-3.

Tip Tuning errors might occur during tuning depending on the type of the synchronous motor and mismatching of P30 setting. Consult with the motor maker for the type and set the type to P30. If it is unknown, execute tuning as P30=0. In this case, it might be necessary to adjust the starting frequency setting F23 or starting frequency continuous time F24.

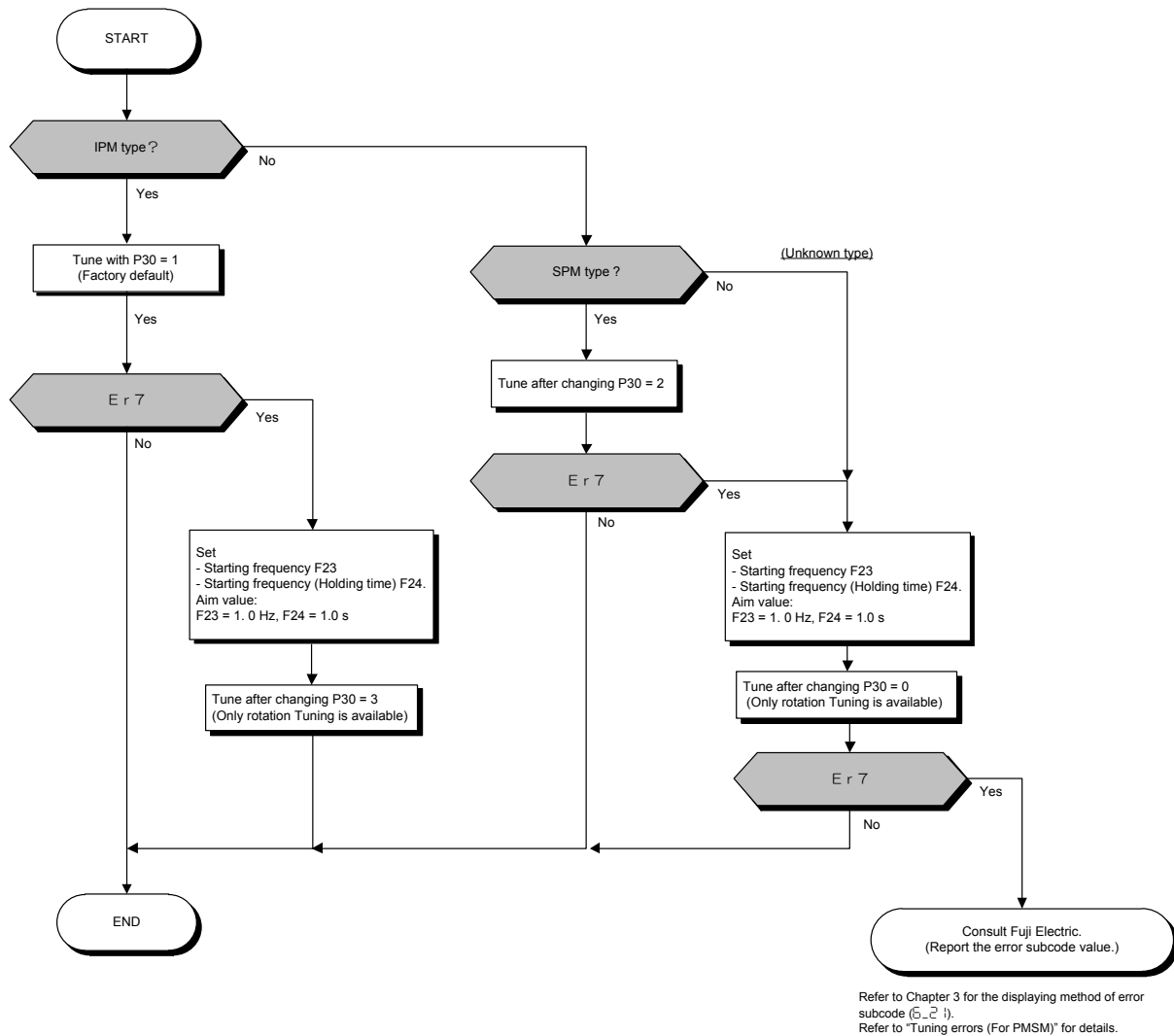

Figure 4.8-3

■ Selection of tuning type

Check the situation of the machine and select either “Tuning with the motor stopped (P04 = 1)” or “Tuning with the motor running (P04 = 2).” For the latter tuning, adjust the acceleration and deceleration times (F07 and F08) and specify the rotation direction that matches the actual rotation direction of the machine.

Note When P30 = 0 (Pull-in by current) or 3 (Pull-in by current for IPMSM), “Tuning with the motor stopped” cannot be performed. In this case the alarm $E_r 7$ with subcode 5003 occurs.

P04 data		Motor parameters subjected to tuning	Tuning	Select under the following conditions
1	Tune while the motor stops.	Armature resistance (P60) d-axis inductance (P61) q-axis inductance (P62) Reserved (P84, P88)	Tuning <u>with the motor stopped</u> .	<ul style="list-style-type: none"> - Impossible to rotate the motor (e.g., when a mechanical load has already been applied to the motor). - P30 is set to “1” or “2.” - See (Note 1).
2	Tune while the motor is rotating	Armature resistance (P60) d-axis inductance (P61) q-axis inductance (P62) Induced voltage (P63) Reserved (P84, P88)	Tuning the armature resistance, d-axis inductance, q-axis inductance, and parameter values (P84 and P88) <u>with the motor stopped</u> . Tuning the induced voltage <u>with the motor running</u> at 50 % of the base frequency.	<ul style="list-style-type: none"> - Possible to rotate the motor, provided that it is safe.



(Note 1) When P30 = 0 (Pull-in by current) or 3 (Pull-in by current for IPMSM), “Tuning with the motor stopped” cannot be performed. In this case the alarm $E_r 7$ with subcode 5003 occurs.

The tuning results of motor parameters will be automatically saved into their respective function codes.

■ Preparation of machine

In preparation for tuning, remove the motor coupling with the load and deactivate the safety devices before rotation tuning.

■ Tuning procedure

- 1) Set function code P04 to “1” or “2” and press the  key. (The blinking of $/$ or \sphericalangle on the LED monitor will slow down.)
- 2) Enter a run command. (The factory default is  key on the keypad for forward rotation.) To switch to reverse rotation or to select the terminal signal **FWD** or **REV** as a run command, change the data of function code F02.
- 3) The moment a run command is entered, the display of $/$ or \sphericalangle lights up, and tuning starts with the motor stopped. (Tuning time: Approx. 5 to 40 s.)
- 4) If P04 = 2, after the tuning in “3)” above, the motor is accelerated to approximately 50% of the base frequency and then tuning starts. Upon completion of measurements, the motor decelerates to a stop. (Estimated tuning time: Acceleration time + 10 s + Deceleration time)
- 5) If the terminal signal **FWD** or **REV** is selected as a run command (F02 = 1), End appears upon completion of the measurements. Turning the run command OFF completes the tuning.
If the run command has been given through the keypad or the communications link, it automatically turns OFF upon completion of the measurements, which completes the tuning.
- 6) Upon completion of the tuning, the subsequent function code appears on the keypad.

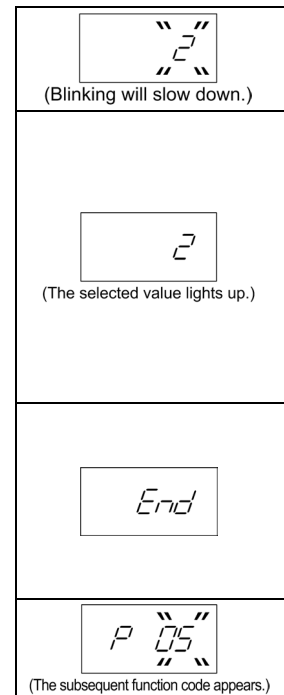

Note The default value of the speed regulator is set low to prevent your system from oscillation (hunting). However, hunting may occur during tuning due to mechanical conditions, causing a tuning error ($E_r 7$), a stepout detection error ($E_r d$) or a speed mismatch error ($E_r E$). If a tuning error ($E_r 7$) or a stepout protection error ($E_r d$) occurs, reduce the gain for the speed regulator; if a speed mismatch error ($E_r E$) occurs, cancel the speed mismatch detection function (d23=0). After that, perform tuning again.

■ Tuning errors (For PMSM)

Improper tuning would negatively affect the operation performance and, in the worst case, could even cause hunting or deteriorate precision. Therefore, if the inverter finds any abnormality in the tuning results or any error in the tuning process, it displays $E_r 7$ and discards the tuning data.

When the tuning error ($E_r 7$) appears, check that:

- The inverter's output (secondary) circuit is not opened.
- The mechanical brake is released.
- The terminal command **BX** ("Coast to a stop") is ON.
- Any function code is wrongly configured.

Listed below are possible causes that trigger tuning errors and measures.

Possible tuning error causes	$E_r 7$ error subcode	Details and Measures
Sequence error	7 8 9	Before completion of tuning, the run command has been turned OFF. Or during tuning, terminal command STOP ("Force to stop") or BX ("Coast to a stop") has been entered. → Do not stop the inverter running until completion of tuning.
Output current error	6 10	During tuning, an excessively large current has flown. → Release a mechanical brake or take any other measure to remove the cause resulting in overcurrent.
Tuning frequency error (only when P04=2)	13	The maximum frequency or the frequency limiter (high) has limited the output frequency. → Increase the F03 and F15 settings to values greater than 50% of the base frequency 1 (F04).
Occurrence of alarm	15	During tuning, any alarm has occurred. → Check the contents of the multiple alarm and remove the error cause. For details, refer to Chapter 6 "TROUBLESHOOTING."
Acceleration timeout (only when P04=2)	18	The output frequency has not reached 50% of the base frequency within the specified acceleration time "F07×300%". → Increase the F07 setting.
Parameter setting error	5003	The rated impedance or rated inductance is out of the effective range. → Check the F04, F05 and P03 settings.
Magnetic pole position calculation failure	5005	When P30 = 1 or 3: The saliency ratio of the motor inductance is low. When P30 = 2: The motor has no magnetic saturation characteristic. → If this error occurs when P30 = 1, decrease the P87 setting. Note that it may fail to tune the motor that does not easily cause magnetic saturation. → If this error occurs when P30 = 2 or 3, change the P30 setting to "0" and adjust the F24 setting (Starting Frequency 1, Holding time) by gradually increasing it in increments of 0.5 to 5.0 s until rotational tuning succeeds.
Lack of magnetic saturation	5056	The magnetic saturation characteristic of the motor is low so that the inverter has failed to discriminate the magnetic pole position. → Gradually increase the P87 setting up a maximum of 120%. If it produces no effect, change the P30 setting to "0" or "3," and the F24 setting to 0.5 to 5.0 s.
Excessive magnetic saturation	5057	The magnetic saturation characteristic of the motor is high so that an excessively large current could flow at the discrimination time of the magnetic pole position. It is dangerous. → Decrease the P87 setting.
Error in tuning results	5059 to 5065	An interphase voltage unbalance or output phase loss has been detected during tuning. Or tuning has resulted in an abnormally high or low value due to the output circuit opened. → Check that there is no abnormality in the inverter's output (secondary) circuit. → If a magnetic contactor (MC) is inserted in the inverter's output (secondary) circuit, check that it is closed.

 For error sub codes, refer to Chapter 3 “3.4.6 Reading alarm information “Alarm Information: *E_{FL}*”.”

 If an error other than *E_r 7* occurs, remove the error cause, referring to Chapter 6 “TROUBLESHOOTING.”



If a tuning error persists, consult your Fuji Electric representative.

-  **Note**
- If a filter other than the Fuji optional output filter (OFL-□□□-□A) is connected to the inverter's output (secondary) circuit, the tuning result cannot be assured.
 - Vibration or noise that may occur when the motor's coupling is elastic can be regarded as normal since it is due to the output voltage pattern applied in tuning. The tuning does not always result in an error; however, run the motor and check its running state.

[2] Driving a Fuji dedicated PMSM (GNB2 series)

For 90 kW or less, the motor parameters are prepared beforehand. After setting P99=21 and initializing by H03=2, required parameters are set.

For more than 90 kW, the motor parameters are notified separately. Never start operation of the synchronous motor until the notified parameters are set.

* To change the data of function code H03, double key operation “ key +  key” is necessary.

* After initialization, the data of function code H03 automatically returns to “0” (Factory default value).



 For details on how to modify the function code data, see Chapter 3 “3.4.1 Setting up function codes “Data Setting: *iF₋₋* through *iD₋₋*”.”

 **Tip** If Fuji standard synchronous motor without magnetic pole position sensor (GNB2 series 1800 r/min specification) of the capacity different from the inverter is used, change P02 accordingly and initialize motor 1 parameters by H03 = 2 (PM motor).

[3] Driving a Fuji non-dedicated PMSM (non-GNB2 series)

Motor parameters are notified separately. After setting P99=20 and initializing by H03=2, set the notified parameters.

Never start operation of the synchronous motor until the notified parameters are set.

To change the data of function code H03, double key operation “ key +  key” is necessary.

After initialization is completed, the data of function code H03 automatically returns to “0” (Factory default value).

 For details on how to modify the function code data, see Chapter 3 “3.4.1 Setting up function codes “Data Setting: *iF₋₋* through *iD₋₋*”.”

4.9 Running the Inverter for Motor Operation Check

After completion of preparations for a test run as described above, start running the inverter for motor operation check using the following procedure.

⚠ WARNING

If the user configures the function codes wrongly without completely understanding this User's Manual, the motor may rotate with a torque or at a speed not permitted for the machine.

Accident or injury may result.

⚠ CAUTION

If any abnormality is found in the inverter or motor, immediately stop operation and investigate the cause referring to Chapter 6 "TROUBLESHOOTING."

4.9.1 Test run procedure

- (1) Turn the power ON and check that the reference frequency $\square.\square\square$ Hz is blinking on the LED monitor.
- (2) Set a low reference frequency such as 5 Hz, using \triangle / ∇ keys. (Check that the frequency is blinking on the LED monitor.)
- (3) Press the RUN key to start running the motor in the forward direction. (Check that the reference frequency is lit on the LED monitor.)
- (4) To stop the motor, press the STOP key.

4.9.2 Check points during a test run

- (1) Check that the motor is running in the forward direction.
- (2) Check for smooth rotation without motor humming or excessive vibration.
- (3) Check for smooth acceleration and deceleration.

When no abnormality is found, press the RUN key again to start driving the motor, then increase the reference frequency using \triangle / ∇ keys. Check the above points again.



Depending on the settings of function codes, the motor speed may rise to an unexpectedly high and dangerous level, particularly, under vector control with speed sensor. To avoid such an event, the speed limiting function is provided.

If the user is unfamiliar with the function code settings (e.g., when the user starts up the inverter for the first time), it is recommended that the "F15: Frequency limiter (Upper limit)" and the torque control "d32: Speed limit 1" and "d33: Speed limit 2" are used. At the startup of the inverter, to ensure safer operation, specify small values to those function codes at first and gradually increase them while checking the actual operation.

The speed limiting function serves as an overspeed level barrier, or as a speed limiter under torque control. For details of the speed limiting function, refer to Chapter 5.



For driving PMSM under vector control without magnetic pole position sensor, when P30 is set to any value other than "0," noise that may occur from the motor at the start of running can be regarded as normal.

Depending on the settings of function codes, the motor speed may rise to an unexpectedly high and dangerous level. To avoid such an event, the speed limiting function is provided.

If the user is unfamiliar with the function code settings (e.g., when the user starts up the inverter for the first time), it is recommended that "F15: Frequency limiter (Upper limit)" is used. At the start-up of the inverter, to ensure safer operation, specify a small value to the function code at first and gradually increase it while checking the actual operation.

4.9.3 Modification of motor control function code data

Modifying the current function code data sometimes can solve an insufficient torque or overcurrent or overvoltage incident. Table 4.9-1 lists the major function codes to be accessed. For details, see Chapter 5 "FUNCTION CODES" and Chapter 6 "TROUBLESHOOTING."

Table 4.9-1

Function code	Name	Modification key points	Drive control		
			IM V/f	IM PG V/f	IM w/ PG
<i>F 07</i>	Acceleration time 1	If the current limiter is activated due to a short acceleration time and large drive current, prolong the acceleration time.	Y	Y	Y
<i>F 08</i>	Deceleration time 1	If an overvoltage trip occurs due to a short deceleration time, prolong the deceleration time.	Y	Y	Y
<i>F 09*</i>	Torque boost 1	If the starting motor torque is deficient under V/f control mode, increase the torque boost. If the motor with no load is overexcited (current increasing), decrease the torque boost.	Y	Y	N
<i>F 44</i>	Current limiter (Mode selection)	If the stall prevention function is activated by the current limiter during acceleration or deceleration, increase the operation level.	Y	Y	N
<i>P 07*</i>	Motor 1 (%R1)	If the starting motor torque is insufficient under automatic torque boost and torque vector control, increase %R1. If the motor with no load is over-excited (current increasing), decrease %R1.	Y	Y	Y
<i>P 09*</i>	Motor 1 (Slip compensation gain for driving)	For excessive slip compensation during driving, decrease the gain; for insufficient one, increase the gain.	Y	N	Y
<i>P 11*</i>	Motor 1 (Slip compensation gain for braking)	For excessive slip compensation during braking, decrease the gain; for insufficient one, increase the gain.	Y	N	N
<i>H 07</i>	Curve acceleration/ deceleration	If overshoot to the change in speed command is large, make curve acceleration/deceleration speed effective.	Y	Y	Y
<i>H 69</i>	Anti-regenerative control (Mode selection)	If overvoltage trip occurs when executing acceleration/deceleration without using the braking resistor, prevent overvoltage trip by making anti-regenerative control effective.	Y	Y	Y
<i>H 80*</i>	Output current fluctuation damping gain for motor 1	It is not necessary to change the setting normally. If the current vibrates by the stall prevention function due to current limitation or the high speed motor is driven, decrease the suppression gain. Even though the stall prevention does not function, if the motor vibrates due to current fluctuation, increase the suppression gain.	Y	Y	N

Y: Modification effective N: Modification ineffective

4.9 Running the Inverter for Motor Operation Check

In the case of V/f control with speed sensor, V/f control with speed sensor and auto torque boost, vector control for induction motor with speed sensor, or Vector control for synchronous motor without speed sensor and magnetic pole position sensor, if the problem is not solved by adjusting the function code in Table 4.9-1, adjust the function code in Table 4.9-2.

In the above control methods, PI regulator is used for speed control. The desired response can be obtained by adjusting the control constants (PI constants) to match the load inertia. The major function codes to adjust are shown below.

For details, see Chapter 5 "FUNCTION CODES" and Chapter 6 "TROUBLESHOOTING."

Table 4.9-2

Function code	Name	How to adjust	IM PG V/f IM w/ PG PM
d 01	Speed control 1 (Speed command filter)	If an excessive overshoot or undershoot occurs for a speed command change, increase the filter constant. If motor response is slow for a speed command change, decrease the filter constant.	Y
d 02	Speed control 1 (Speed detection filter)	If ripples are superimposed on the speed detection signal so that the speed control gain cannot be increased, increase the filter constant to obtain a larger gain. It is not necessary to change the factory default normally.	Y
d 03	Speed control 1 P (Gain)	If hunting is caused in the motor speed control, decrease the gain. If speed mismatch or excessive speed deviation ($E_r - E$) occurs because the motor response is slow, increase gain.	Y
d 04	Speed control 1 I (Integral time)	If speed mismatch or excessive speed deviation ($E_r - E$) occurs because the motor response is slower, decrease the integration time. If the load inertia is large, increase the integration time.	Y

4.10 Selecting a Frequency Command Source

The frequency command source by factory default is the keypad (\triangleleft / \triangleright keys). This section provides the frequency command setting procedures using the frequency command sources of the keypad, external potentiometer, and frequency selection terminal commands.

4.10.1 Setting up a frequency command from the keypad

Follow the procedure given below.

- (1) Configure the function codes as listed below.

Function code	Name	Function code data	Factory default
F01	Frequency Command 1	0: Keypad (\triangleleft / \triangleright keys)	0

- Note**
- When the inverter is in Programming or Alarm mode, frequency command setting with \triangleleft / \triangleright keys is disabled. To enable it, switch to Running mode.
 - If any of higher priority frequency command sources (multistep frequency commands and frequency commands via communications link) is specified, the inverter may run at an unexpected frequency.

- (2) Press the \triangleleft / \triangleright key to display the current frequency command on the LED monitor. The least significant digit blinks.

- (3) To change the frequency command, press the \triangleleft / \triangleright key again.

When you start specifying the frequency command with the \triangleleft / \triangleright key, the least significant digit on the display blinks; that is, the cursor is located in the least significant digit. Holding down the \triangleleft / \triangleright key changes data in the least significant digit and generates a carry, while the cursor remains in the least significant digit.

- (4) To save the new setting into the inverter's memory, press the FUNC key.

 For details on how to modify the function code data, see Chapter 3 "3.4.1 Setting up function codes "Data Setting: $iF_{_}$ through $iD_{_}$."

4.10.2 Setting up a frequency command with an external potentiometer

Follow the procedure given below.

- (1) Configure the function codes as listed below.

Function code	Name	Function code data	Factory default
F01	Frequency Command 1	1: Analog voltage input to terminal [12] (0 to ± 10 V)	0

- Note** If terminal [FWD] and [REV] are ON (short-circuited), the F01 data cannot be changed. First turn those terminals OFF and then change the F01 data.

- (2) Connect an external potentiometer to terminals [11] through [13] of the inverter.

- (3) Rotate the external potentiometer to apply voltage to terminal [12] for a frequency command input.

 For precautions in wiring, refer to Chapter 2 "INSTALLATION AND WIRING."

 For details on how to modify the function code data, see Chapter 3 "3.4.1 Setting up function codes "Data Setting: $iF_{_}$ through $iD_{_}$."

4.10.3 Setting up a frequency command with multistep frequency selection

Follow the procedure given below.

- (1) Configure the function codes as listed below.

Function code	Name	Function code data	Factory default
E01 to E05	Terminal [X1] to [X5] Functions	0, 1, 2, 3: Multistep frequency 1 to 15 (0: "SS1", 1: "SS2", 2: "SS4", 3: "SS8")	0
C05 to C19	Multistep Frequency 1 to 15	0.00 to 500.00 Hz	0.00

Assign signals "SS1", "SS2", "SS4" and "SS8" to four out of five digital input terminals [X1] to [X5] by respective function codes E01 to E05 (data = 0, 1, 2 and 3). Specify multistep frequency commands with C05 to C19.

Turning digital signals "SS1", "SS2", "SS4" and "SS8" ON or OFF selectively switches the multistep frequency commands specified beforehand, as shown in the table below.

Combination of input signals				Selected frequency command	
3 "SS8"	2 "SS4"	1 "SS2"	0 "SS1"		
OFF	OFF	OFF	ON	C05 (Multistep frequency 1)	Related function codes C05 to C19 Data setting range: 0.00 to 500.00
OFF	OFF	ON	OFF	C06 (Multistep frequency 2)	
OFF	OFF	ON	ON	C07 (Multistep frequency 3)	
OFF	ON	OFF	OFF	C08 (Multistep frequency 4)	
OFF	ON	OFF	ON	C09 (Multistep frequency 5)	
OFF	ON	ON	OFF	C10 (Multistep frequency 6)	
OFF	ON	ON	ON	C11 (Multistep frequency 7)	
ON	OFF	OFF	OFF	C12 (Multistep frequency 8)	
ON	OFF	OFF	ON	C13 (Multistep frequency 9)	
ON	OFF	ON	OFF	C14 (Multistep frequency 10)	
ON	OFF	ON	ON	C15 (Multistep frequency 11)	
ON	ON	OFF	OFF	C16 (Multistep frequency 12)	
ON	ON	OFF	ON	C17 (Multistep frequency 13)	
ON	ON	ON	OFF	C18 (Multistep frequency 14)	
ON	ON	ON	ON	C19 (Multistep frequency 15)	

- (2) Connect a multistep frequency switch to an X terminal and [CM].
- (3) Turn the multistep frequency switch ON (short-circuit). The combination of those input signals selects a multistep frequency command.



For precautions in wiring, refer to Chapter 2 "INSTALLATION AND WIRING."





For details on how to modify the function code data, see Chapter 3 "3.4.1 Setting up function codes "Data Setting: iF_{-} through iD_{-} ."



Note Enabling a multistep frequency command with a multistep frequency switch (ON between X terminal and [CM]) disables the frequency command 1 specified by F01.

4.11 Selecting a Run Command Source



A run command source is the keypad ( and ) keys by factory default.

4.11.1 Setting up a run command from the keypad

Follow the procedure given below.

- (1) Configure the function codes as listed below.

Function code	Name	Function code data	Factory default
F02	Operation Method	0: Keypad operation (Rotation direction input: Terminal block) 2: Keypad operation (Forward direction) 3: Keypad operation (Reverse direction)	2: Keypad operation (Forward direction)

- (2) When F02 = 0: Press the  key to run the motor. Press the  key to stop it.

The rotation direction is specified by terminals [FWD] and [REV]. Connect the run forward switch between terminals [FWD] and [CM] and the run reverse switch between [REV] and [CM].



Note Make sure that the SINK/SOURCE slide switch (SW1) is turned to the SINK position. If SW1 is in the SOURCE position, the inverter cannot run the motor.

- (3) When F02 = 2: Press the  key to run the motor in the forward direction. Press the  key to stop it.

- (4) When F02 = 3: Press the  key to run the motor in the reverse direction. Press the  key to stop it.



For details on how to modify the function code data, see Chapter 3 “3.4.1 Setting up function codes “Data Setting: *!F_* through *!D_*.”

4.11.2 Setting up a run command with digital input signals (terminals [FWD] and [REV])

Follow the procedure given below.

- (1) Configure the function codes as listed below.

Function code	Name	Function code data	Factory default
F02	Operation Method	1: External digital input signal	2: Keypad operation (Forward direction)



Note If terminal [FWD] and [REV] are ON (short-circuited), the F02 data cannot be changed. First turn those terminals OFF and then change the F02 data.

- (2) Connect the run forward switch between terminals [FWD] and [CM] and the run reverse switch between [REV] and [CM].



Note Make sure that the SINK/SOURCE slide switch (SW1) is turned to the SINK position. If SW1 is in the SOURCE position, the inverter cannot run the motor.

- (3) Turn the run forward switch or run reverse switch ON (short-circuit) to run the motor in the forward or reverse direction, respectively.



For precautions in wiring, refer to Chapter 2 “INSTALLATION AND WIRING.”





For details on how to modify the function code data, see Chapter 3 “3.4.1 Setting up function codes “Data Setting: *!F_* through *!D_*.”

Chapter 5 FUNCTION CODES

This chapter explains the table of function codes used in FRENIC-Ace, index per purpose, and the detail of each function code.

Contents

5.1	Function Codes Overview	5-1
5.2	Function Codes Table	5-2
5.2.1	Supplementary note	5-2
5.2.2	Function codes table	5-4
5.2.3	Factory default value per applicable electric motor capacitance	5-36
5.2.4	Motor constants	5-37
[1]	When Fuji standard motor 8-series, or other motors are selected by motor selection (Function code P99/ A39 = 0 or 4)	5-37
[2]	When HP rating motor is selected by motor selection (Function code P99/A39 = 1)	5-41
5.3	Description of Function Codes	5-45
5.3.1	F codes (Basic functions)	5-45
[1]	Frequency setting by keypad (F01 = 0 (Factory default state), 8)	5-47
[2]	Setting up a reference frequency using analog input (F01 = 1 to 3, 5)	5-48
[3]	Frequency setting by digital input signal "UP"/"DOWN" (F01=7)	5-54
[4]	Frequency setting using digital inputs (option DIO interface card) (F01 = 11)	5-55
[5]	Frequency setting using pulse train input (F01 = 12)	5-55
5.3.2	E codes (Extension terminal functions)	5-100
5.3.3	C codes (Control functions)	5-139
5.3.4	P codes (Motor 1 parameters)	5-148
5.3.5	H codes (High performance functions)	5-155
[1]	Measuring the capacitance of DC link bus capacitor in comparison with initial one at shipment	5-171
[2]	Measuring the capacitance of DC link bus capacitor under ordinary operating conditions at power shutdown	5-172
5.3.6	A codes (Motor 2 parameters)	5-193
5.3.7	b, r codes (Speed control 3 and 4 parameters)	5-196
5.3.8	J codes (Applied functions)	5-197
[1]	PID command with the  /  keys on the keypad (J02 = 0, factory default)	5-198
[2]	PID command by analog inputs (J02 = 1)	5-199
[3]	PID command with UP/DOWN control (J02 = 3)	5-201
[4]	PID command via communications link (J02 = 4)	5-201

[5]	Overload stop function	5-213
[6]	Brake control signal	5-214
[7]	Positioning control with pulse counter	5-217
[8]	Servo lock	5-226
5.3.9	d codes (Applied functions 2)	5-228
[1]	Speed control	5-228
[2]	Master-follower operation	5-238
5.3.10	U codes (Customizable logic operation)	5-248
5.3.11	U1 codes (Customizable logic operation)	5-273
5.3.12	y codes (Link functions)	5-277

5.1 Function Codes Overview







Function codes are used for selecting various functions of FRENIC-Ace. Function codes comprise 3 digits or 4 digits of alphanumeric character. The first digit categorizes the group of function code alphabetically and the subsequent 2 or 3 digits identify each code within the group by number. Function code comprises 11 groups: Basic function (F code), Terminal function (E code), Control code (C code), Motor 1 parameter (P code), High-level function (H code) (H1 code), Motor 2 parameter (A code), Application function 1 (J code) (J1 code), Application function 2 (d code), Customizable logic (U code) (U1 code), Link function (y code), Keypad functions (K code), and Option function (o code). The function of each function code is determined according to the data to be set. The following descriptions are for supplementary explanation of function code table. Refer to instruction manual of each option to find the details of the option function (o code).

5.2 Function Codes Table

5.2.1 Supplementary note

■ Change, reflect, and save function code data during operation

Function codes are categorized into those which data change is enabled during operation of the inverter and those which such change is disabled. The meaning of the code in the “Change during operation” column of the function code table is described in the following table.

Code	Change during operation	Reflect and save data
Y*	Allowed	At the point when data is changed by  key, the changed data is immediately reflected on the operation of inverter. However, at this stage, the changed value is not saved to the inverter. In order to save it to the inverter, press  key. Without saving by  key and leaving the state of when the change was made by the  key, the data before the change is reflected on the operation of inverter.
Y	Allowed	Even if data is changed by the  key, the changed data will not be reflected on the operation of the inverter as is; by pressing the  key, the changed value is reflected on the operation of the inverter and is also saved to the inverter.
N	Not allowed	—

■ Copying data

Function code data can be copied collectively by using the optional keypad “TP-E1U” (program mode menu number 7 “Data copy”). By using this function, it is possible to read out all function code data and write the same data to a different inverter.

However, if the specification of inverter at the copy source and copy destination is not identical, some function codes may not be copied due to security reason. According to necessity, configure the settings individually for the function codes that are not copied. The behaviour of the function codes regarding data copy is indicated in the “data copy” column in the function code table in the next page and following.

- Y: to be copied.
- Y1: When inverter capacity is different, copying will not be performed.
- Y2: When voltage group is different, copying will not be performed.
- N: not to be copied.

■ Negative logic setting of data

Digital input terminal and transistor/contact output terminal can become a signal for which negative logic is specified by function code data setting. Negative logic is a function to reverse ON and OFF state of input or output, and switch Active ON (function enabled with ON: positive logic) and Active OFF (function enabled with OFF: negative logic). However, negative logic may not be enabled depending on the function of the signal.

Negative logic signal can be switched by setting the data with 1000 added to the function code data of the function to be set. For example, the following example shows when coast to a stop command “BX” is selected by function code E01.

Function code data	Action
7	“BX” is ON and coast to a stop (Active ON)
1007	“BX” is OFF and coast to a stop (Active OFF)

■ Drive control

The FRENIC-Ace runs under any of the following drive controls. Some function codes apply exclusively to the specific drive control, which is indicated by letters Y (Applicable) and N (Not applicable) in the “Drive control” column in the function code tables given on the following pages.

Abbreviation in “Drive control” column in function code tables	Control target (H18)	Drive control (F42)
V/f	Speed (Frequency for V/f and PG V/f)	0,2: V/f control 1: Dynamic torque vector control
PG V/f		3: V/f control with speed sensor 4: V/f control with speed sensor and auto torque boost
w/ PG		6: Vector control with speed sensor
Torque control	Torque	6: Vector control with speed sensor
PM	Speed	15: Vector control without speed sensor nor pole position sensor

For details about the drive control, refer to the description of F42 “Drive control selection 1.”

Note The FRENIC-Ace is a general-purpose inverter whose operation is customized by frequency-basis function codes, like conventional inverters. Under the speed-basis drive control, however, the control target is a motor speed, not a frequency, so convert the frequency to the motor speed according to the following expression.

$$\text{Motor speed (r/min)} = 120 \times \text{Frequency (Hz)} \div \text{Number of poles}$$

5.2.2 Function codes table

The table of function codes to be used in FRENIC-Ace is shown below.

■ F codes: Fundamental Functions (Basic function)

Code	Name	Data setting range	Change when running	Data copying	Factory Default	Drive control					Related page
						V/f	PG V/f	w/ PG	Torque control	PM	
F00	Data protection	0: No data protection, no digital setting protection 1: With data protection, no digital setting protection 2: No data protection, with digital setting protection 3: With data protection, with digital setting protection	Y	Y	0	Y	Y	Y	Y	Y	5-45
F01	Frequency setting 1	0: Keypad key operation (⏏/⏏key) 1: Analog voltage input (Terminal [12]) (from 0 to ±10 VDC) 2: Analog current input (Terminal [C1] (C1 function)) (4 to 20mA DC, 0 to 20mA DC) 3: Analog voltage input (Terminal [12]) + Analog current input (Terminal [C1] (C1 function)) 5: Analog voltage input (Terminal [C1] (V2 function)) (0 to 10 VDC) 7: UP/DOWN control 8: Keypad key operation (⏏/⏏key) (With balanceless bumpless) 10: Pattern operation 11: Digital input/output interface card (option) *5 12: Pulse train input	N	Y	0	Y	Y	Y	N	Y	5-46
F02	Operation method	0: Keypad operation (rotation direction input: terminal block) 1: External signal (digital input) 2: Keypad operation (forward rotation) 3: Keypad operation (Reverse rotation)	N	Y	2	Y	Y	Y	Y	Y	5-57
F03	Maximum output frequency 1	25.0 to 500.0 Hz	N	Y	200V class AJKU:60.0 400V class ACE:50.0 JKU:60.0	Y	Y	Y	Y	Y	5-58
F04	Base frequency 1	25.0 to 500.0Hz	N	Y	200V class J:50.0 AUK:60.0 400V class ACEJ:50.0 UK:60.0	Y	Y	Y	Y	Y	5-59
F05	Rated voltage at base frequency 1	0: AVR disable (output voltage proportional to power voltage) 80 to 240 V : AVR operation (200V class) 160 to 500V : AVR operation (400V class)	N	Y2	200V class J:200 AK:220 U:230	Y	Y	Y	Y	Y	
F06	Maximum output voltage 1	80 to 240V : AVR operation (200V class) 160 to 500V : AVR operation (400V class)	N	Y2	400V class EJ:400 A:415 CK:380 U:460	Y	Y	N	Y	Y	
F07	Acceleration time1	0.00 to 6000 s	Y	Y	6.00 or 20.0 *10	Y	Y	Y	N	Y	5-61
F08	Deceleration time1	* 0.00 is for acceleration and deceleration time cancel (when performing soft-start and stop externally)	Y	Y		Y	Y	Y	N	Y	
F09	Torque boost 1	0.0 to 20.0% (% value against base frequency voltage 1)	Y	Y	*2	Y	Y	N	N	N	5-63
F10	Electronic thermal overload protection for motor 1 (Select motor characteristics)	1: Enable (For a general-purpose motor with self-cooling fan) 2: Enable (For an inverter-driven motor (FV) with separately powered cooling fan)	Y	Y	1	Y	Y	Y	Y	Y	5-63
F11	(Overload detection level)	0.00 (disable), current value of 1 to 135% of inverter rated current (Inverter rated current dependent on F80)	Y	Y1 Y2	*3	Y	Y	Y	Y	Y	
F12	(Thermal time constant)	0.5 to 75.0 min	Y	Y	*4	Y	Y	Y	Y	Y	

Factory default**A (For Asia), C (for China), E (for Europe), U (For USA), J (for Japan), K (for Korea)

■ indicates quick setup target function code.

*2: Factory defaults are depended on motor capacity. Refer to "5.2.3 Factory default value per applicable electric motor capacitance".

*3: The motor rated current is automatically set. Refer to "5.2.4 Motor constant".

*4: 5.0min for inverters of nominal applied motor 22kW or below; 10.0min for those of 30kW or above.

*5: Available at ROM version 0300 or later.

*10:6.00s for inverters of nominal applied motor 22kW or below; 20.0s for those of 30kW or above.

5.2 Function Codes Table

Code	Name	Data setting range	Change when running	Data copying	Factory Default	Drive control					Related page
						V/f	PG V/f	w/PG	Torque control	PM	
F14	Restart mode after momentary power failure (Mode selection)	0: Trip immediately 1: Trip after a recovery from power failure 2: Trip after momentary deceleration is stopped 3: Continue to run (for heavy inertia load or general load) 4: Restart from frequency at power failure (for general load) 5: Restart from starting frequency	Y	Y	EU: 0 ACJK:1	Y	Y	Y	N	Y	5-66
F15	Frequency limiter (Upper limit)	0.0 to 500.0Hz	Y	Y	70.0	Y	Y	Y	N	Y	5-73
F16	(Lower limit)	0.0 to 500.0Hz	Y	Y	0.0	Y	Y	Y	N	Y	
F18	Bias (for frequency setting 1)	-100.00 to 100.00%	Y*	Y	0.00	Y	Y	Y	N	Y	5-73
F20	DC braking 1 (Braking starting frequency)	0.0 to 60.0Hz	Y	Y	0.0	Y	Y	Y	N	Y	5-74
F21	(Braking level)	0 to 100% (HHD mode), 0 to 80% (HD/HND mode) 0 to 60% (ND mode)	Y	Y	0	Y	Y	Y	N	Y	
F22	(Braking time)	0.00 (Disable): 0.01 to 30.00 s	Y	Y	0.00	Y	Y	Y	N	Y	
F23	Starting frequency 1	0.0 to 60.0Hz	Y	Y	0.5	Y	Y	Y	N	Y	5-77
F24	(Holding time)	0.00 to 10.00 s	Y	Y	0.00	Y	Y	Y	N	Y	
F25	Stop frequency	0.0 to 60.0 Hz	Y	Y	0.2	Y	Y	Y	N	Y	
F26	Motor sound (Carrier frequency)	ND mode - 0.75 to 10 kHz (FRN0002 to 0059E2-4□) - 0.75 to 6 kHz (FRN0072E2-4□ or above) HD/HND mode - 0.75 to 16 kHz (FRN0001 to 0088E2-2□) - 0.75 to 16 kHz (FRN0002 to 0059E2-4□) - 0.75 to 16 kHz (FRN0001 to 0012E2-7□) - 0.75 to 10 kHz (FRN0072 to 0168E2-4□) - 0.75 to 10 kHz (FRN0115E2-2□) - 0.75 to 6 kHz (FRN0203E2-4□ or above) HHD mode - 0.75 to 16 kHz (FRN0001 to 0115E2-2□) - 0.75 to 16 kHz (FRN0002 to 0168E2-4□) - 0.75 to 16 kHz (FRN0001 to 0012E2-7□) - 0.75 to 10 kHz (FRN0203E2-4□ or above)	Y	Y	2	Y	Y	Y	Y	Y	5-80
F27	(Tone)	0: Level 0 (Disable) 1 to 3 : Level 1 to 3	Y	Y	0	Y	Y	N	N	N	
F29	Terminal FM (Mode selection)	0: Voltage output (0 to +10 VDC) 1: Current output (4 to 20 mA DC) 2: Current output (0 to 20 mA DC) 3: Pulse output	Y	Y	0	Y	Y	Y	Y	Y	5-81
F30	(Output gain)	0 to 300%	Y*	Y	100	Y	Y	Y	Y	Y	
F31	(Function selection)	0: Output frequency 1 (before slip compensation) 1: Output frequency 2 (after slip compensation) 2: Output current 3: Output voltage 4: Output torque 5: Load factor 6: Input power 7: PID feedback value 8: Actual speed/estimated speed *5 9: DC link bus voltage 10: Universal AO 13: Motor output 14: Calibration (+) 15: PID command (SV) 16: PID output (MV) 17: Position error in master-follower operation *5 18: Inverter heat sink temperature 21: PG feedback value *5 111 to 120 Customizable logic output signal 1 to 10	Y	Y	0	Y	Y	Y	N	Y	
F32	Terminal FM 2 *1 (Mode selection)	0: Voltage output (0 to +10 VDC) 1: Current output (4 to 20 mA DC) 2: Current output (0 to 20 mA DC)	Y	Y	0	Y	Y	Y	Y	Y	
F33	Terminal FM (Pulse rate)	25 to 32000 p/s (number of pulse at monitor value 100%)	Y*	Y	1440	Y	Y	Y	Y	Y	
F34	Terminal FM 2 *1 (Output gain)	0 to 300%	Y*	Y	100	Y	Y	Y	Y	Y	
F35	(Function selection)	Same as F31	Y	Y	2	Y	Y	Y	N	Y	

Factory default**A (For Asia), C (for China), E (for Europe), U (For USA), J (for Japan), K (for Korea)

■ indicates quick setup target function code.

*1: F34 and F35 only exist for GB model and C model (for China).

*5: Available at ROM version 0300 or later.

5.2 Function Codes Table

Code	Name	Data setting range	Change when running	Data copying	Factory Default	Drive control					Related page
						V/f	PG V/f	w/ PG	Torque control	PM	
F37	Load selection/ Auto torque boost/ Auto energy-saving operation 1	0: Variable torque load 1: Constant torque load 2: Auto torque boost 3: Auto energy-saving operation (variable torque load) 4: Auto energy-saving operation (constant torque load) 5: Auto energy-saving operation with auto torque boost	N	Y	1	Y	Y	Y	N	N	5-84
F38	Stop frequency (Detection mode) *5	0: Actual speed / estimated speed 1: Reference speed	N	Y	0	N	N	Y	N	N	5-86
F39	Stop frequency (Holding time)	0.00 to 10.00 s	Y	Y	0.00	Y	Y	Y	N	Y	
F40	Torque limiter 1 (Driving)	0 to 300%; 999 (Disable)	Y	Y	999	Y	Y	Y	Y	Y	5-86
F41	(Braking)	0 to 300%; 999 (Disable)	Y	Y	999	Y	Y	Y	Y	Y	
F42	Drive control selection 1	0: V/f control without slip compensation 1: Vector control without speed sensor (dynamic torque vector) 2: V/f control with slip compensation 3: V/f control with speed sensor *5 4: V/f control with speed sensor and auto torque boost *5 6: Vector control for induction motor with speed sensor *5 15: Vector control for synchronous motor without speed sensor nor pole position sensor *5	N	Y	0	Y	Y	Y	Y	Y	5-92
F43	Current limiter (Mode selection)	0: Disable (No current limiter works.) 1: Enable at constant speed (Disable during ACC/DEC) 2: Enable during ACC/constant speed operation	Y	Y	2	Y	Y	N	N	N	5-96
F44	(Level)	20 to 200% (Rated current of the inverter for 100%)	Y	Y	J:180/160 ACEKU: 130	Y	Y	N	N	N	
F50	Electronic thermal overload protection for braking resistor (Discharging capacity)	1 to 9000 kW OFF (Cancel)	Y	Y1 Y2	OFF	Y	Y	Y	Y	Y	5-97
F51	(Allowable average loss)	0.001 to 99.99 kW	Y	Y1 Y2	0.001	Y	Y	Y	Y	Y	
F52	(Braking resistance value)	0.00: Resistance not required (Compatible mode with FRENIC-Multi series) 0.01 to 999 Ω	Y	Y1 Y2	0.00	Y	Y	Y	Y	Y	
F80	Switching between ND, HD, HND and HHD drive modes	0: HHD mode 1: HND mode 3: HD mode 4: ND mode ND/HD mode is not supported for 200V class series.	N	Y	4	Y	Y	Y	Y	Y	5-99

Factory default***A (For Asia), C (for China), E (for Europe), U (For USA), J (for Japan), K (for Korea)
*5: Available at ROM version 0300 or later.

■ E code: Extension Terminal Functions (Terminal function)

Code	Name	Data setting range	Change when running	Data copying	Factory Default	Drive control					Related page
						V/f	PG V/f	w/ PG	Torque control	PM	
E01	Terminal [X1] function	0 (1000): Select multistep frequency (0 to 1 steps) "SS1"	N	Y	0	Y	Y	Y	N	Y	5-100
E02	Terminal [X2] function	1 (1001): Select multistep frequency (0 to 3 steps) "SS2"	N	Y	1	Y	Y	Y	N	Y	
E03	Terminal [X3] function	2 (1002): Select multistep frequency (0 to 7 steps) "SS4"	N	Y	2	Y	Y	Y	N	Y	
E04	Terminal [X4] function	3 (1003): Select multistep frequency (0 to 15 steps) "SS8"	N	Y	7	Y	Y	Y	N	Y	
E05	Terminal [X5] function	4 (1004): Select ACC/DEC time (2 steps) "RT1"	N	Y	8	Y	Y	Y	N	Y	
		5 (1005): Select ACC/DEC time (4 steps) "RT2"				Y	Y	Y	N	Y	
		6 (1006): Select 3-wire operation "HLD"				Y	Y	Y	N	Y	
		7 (1007): Coast to a stop command "BX"				Y	Y	Y	Y	Y	
		8 (1008): Reset alarm (Abnormal) "RST"				Y	Y	Y	Y	Y	
		9 (1009): External alarm (9 = Active OFF/ 1009 = Active ON) "THR"				Y	Y	Y	Y	Y	
		10 (1010): Ready for jogging "JOG"				Y	Y	Y	N	N	
		11 (1011): Select frequency setting 2/ frequency setting 1 "Hz2/ Hz1"				Y	Y	Y	N	Y	
		12 (1012): Select motor 2 "M2"				Y	Y	Y	Y	Y	
		13: DC braking command "DCBRK"				Y	Y	Y	N	N	
		14 (1014): Select torque limit 2/ torque limit 1 "TL2/ TL1"				Y	Y	Y	Y	Y	
		15: Switch to commercial power (50 Hz) "SW50"				Y	Y	N	N	N	
		16: Switch to commercial power (60 Hz) "SW60"				Y	Y	N	N	N	
		17 (1017): UP command "UP"				Y	Y	Y	N	Y	
		18 (1018): DOWN command "DOWN"				Y	Y	Y	N	Y	
		19 (1019): Allow function code editing (Data change enabled) "WE-KP"				Y	Y	Y	Y	Y	
		20 (1020): Cancel PID control "Hz/PID"				Y	Y	Y	N	Y	
		21 (1021): Switch normal/ inverse operation "IVS"				Y	Y	Y	N	Y	
		22 (1022): Interlock "IL"				Y	Y	Y	Y	Y	
		23 (1023): Cancel torque control *5 "Hz/TRQ"				N	N	N	Y	N	
		24 (1024): Select link operation (RS-485, BUS option) "LE"				Y	Y	Y	Y	Y	
		25 (1025): Universal DI "U-DI"				Y	Y	Y	Y	Y	
		26 (1026): Select auto search for idling motor speed at starting "STM"				Y	Y	N	N	Y	
		30 (1030): Force to stop (30 = Active OFF/1030 = Active ON) "STOP"				Y	Y	Y	Y	Y	
		32 (1032): Pre-excite *5 "EXITE"				N	N	Y	Y	N	
		33 (1033): Reset PID integral and differential terms "PID-RST"				Y	Y	Y	N	Y	
		34 (1034): Hold PID integral term "PID-HLD"				Y	Y	Y	N	Y	
		35 (1035): Select local (Keypad) command "LOC"				Y	Y	Y	Y	Y	
		42 (1042): Activate the limit switch at start point *5 "LS"				Y	Y	N	N	N	
		43 (1043): Start / Reset *5 "S/R"				Y	Y	N	N	N	
		44 (1044): Switch to the serial pulse receiving mode *5 "SPRM"				Y	Y	N	N	N	
		45 (1045): Enter the return mode *5 "RTN"				Y	Y	N	N	N	
		46 (1046): Enable overload stop "OLS"				Y	Y	Y	N	Y	
		47 (1047): Servo lock command *5 "LOCK"				N	N	Y	N	N	
		48: Pulse train input (Only for X5 terminal (E05)) "PIN"				Y	Y	Y	N	Y	
		49 (1049): Pulse train sign (Other than X5 terminal (E01 to E04)) "SIGN"				Y	Y	Y	N	Y	
		59 (1059): Enable battery-driven operation *11 "BATRY/UPS"				Y	Y	Y	N	N	
		60 (1060): Select torque bias1 *5 "TB1"				N	N	Y	N	N	
		61 (1061): Select torque bias2 *5 "TB2"				N	N	Y	N	N	
		62 (1062): Hold torque bias *5 "H-TB"				N	N	Y	N	N	
		65 (1065): Check brake "BRKE"				Y	Y	Y	N	N	
		70 (1070): Cancel line speed control *5 "Hz/LSC"				Y	Y	Y	N	N	

*5: Available at ROM version 0300 or later.
 *11: Available at ROM version 0500 or later.

5.2 Function Codes Table

Code	Name	Data setting range	Change when running	Data copying	Factory Default	Drive control					Related page
						V/f	PG V/f	w/PG	Torque control	PM	
		71 (1071): Hold line speed control frequency in the memory *5 "LSC-HLD"				Y	Y	Y	N	N	
		72 (1072): Count the run time of commercial power-driven motor 1 *5 "CRUN-M1"				Y	Y	Y	Y	N	
		73 (1073): Count the run time of commercial power-driven motor 2 *5 "CRUN-M2"				Y	Y	Y	Y	N	
		76 (1076): Select droop control "DROOP"				Y	Y	Y	N	N	
		78 (1078): Select speed control parameter 1 *5 "MPRM1"				N	Y	Y	Y	Y	
		79 (1079): Select speed control parameter 2 *5 "MPRM2"				N	Y	Y	Y	Y	
		80 (1080): Cancel customizable logic "CLC"				Y	Y	Y	Y	Y	
		81 (1081): Clear all customizable logic timers "CLTC"				Y	Y	Y	Y	Y	
		82 (1082): Cancel anti-regenerative control "AR-CCL"				Y	Y	Y	N	Y	
		100: No function assigned "NONE"				Y	Y	Y	Y	Y	
		171 (1171): PID control multistage command 1 "PID-SS1"				Y	Y	Y	N	Y	
		172 (1172): PID control multistage command 2 "PID-SS2"				Y	Y	Y	N	Y	
		* Inside the () is the negative logic signal (OFF at short-circuit)									
E10	Acceleration time2	0.00 to 6000 s	Y	Y	6.00	Y	Y	Y	N	Y	5-116
E11	Deceleration time2	* 0.00 is for acceleration and deceleration time cancel (when performing soft-start and stop externally)	Y	Y	or 20.0	Y	Y	Y	N	Y	
E12	Acceleration time 3		Y	Y	*10	Y	Y	Y	N	Y	
E13	Deceleration time 3		Y	Y		Y	Y	Y	N	Y	
E14	Acceleration time 4		Y	Y		Y	Y	Y	N	Y	
E15	Deceleration time 4		Y	Y		Y	Y	Y	N	Y	
E16	Torque limiter 2 (Driving)	0 to 300%; 999 (Disable)	Y	Y	999	Y	Y	Y	Y	Y	5-116
E17	(Braking)	0 to 300%; 999 (Disable)	Y	Y	999	Y	Y	Y	Y	Y	
E20	Terminal [Y1] function	0 (1000): Inverter running "RUN"	N	Y	0	Y	Y	Y	Y	Y	5-117
E21	Terminal [Y2] function	1 (1001): Frequency (speed) arrival "FAR"	N	Y	7	Y	Y	Y	N	Y	
E27	Terminal [30A/B/C] function (Relay output)	2 (1002): Frequency (speed) detected "FDT"	N	Y	99	Y	Y	Y	Y	Y	
		3 (1003): Under voltage detected (inverter stopped) "LU"				Y	Y	Y	Y	Y	
		4 (1004): Detected torque polarity "B/D"				Y	Y	Y	Y	Y	
		5 (1005): Inverter output limiting "IOL"				Y	Y	Y	Y	Y	
		6 (1006): Auto-restarting after momentary power failure "IPF"				Y	Y	Y	Y	Y	
		7 (1007): Motor overload early warning "OL"				Y	Y	Y	Y	Y	
		8 (1008): Keypad operation enabled "KP"				Y	Y	Y	Y	Y	
		10 (1010): Inverter ready to run "RDY"				Y	Y	Y	Y	Y	
		15 (1015): Switch MC on the input power lines "AX"				Y	Y	Y	Y	Y	
		16 (1016): Pattern operation stage transition "TU"				Y	Y	Y	N	Y	
		17 (1017): Pattern operation cycle completed "TO"				Y	Y	Y	N	Y	
		18 (1018): Pattern operation stage 1 "STG1"				Y	Y	Y	N	Y	
		19 (1019): Pattern operation stage 2 "STG2"				Y	Y	Y	N	Y	
		20 (1020): Pattern operation stage 4 "STG4"				Y	Y	Y	N	Y	
		21 (1021): Frequency (speed) arrival 2 "FAR2"				Y	Y	Y	N	Y	
		22 (1022): Inverter output limiting with delay "IOL2"				Y	Y	Y	Y	Y	
		25 (1025): Cooling fan in operation "FAN"				Y	Y	Y	Y	Y	
	26 (1026): Auto-resetting "TRY"				Y	Y	Y	Y	Y		
	27 (1027): Universal DO "U-DO"				Y	Y	Y	Y	Y		
	28 (1028): Heat sink overheat early warning "OH"				Y	Y	Y	Y	Y		
	29 (1029): Synchronization completed *5 "SY"				N	Y	Y	N	N		
	30 (1030): Lifetime alarm "LIFE"				Y	Y	Y	Y	Y		
	31 (1031): Frequency (speed) detected 2 "FDT2"				Y	Y	Y	Y	Y		
	33 (1033): Reference loss detected "REF OFF"				Y	Y	Y	N	Y		
	35 (1035): Inverter outputting "RUN 2"				Y	Y	Y	Y	Y		
	36 (1036): Overload prevention controlling "OLP"				Y	Y	Y	N	Y		
	37 (1037): Current detected "ID"				Y	Y	Y	Y	Y		
	38 (1038): Current detected 2 "ID2"				Y	Y	Y	Y	Y		
	39 (1039): Current detected 3 "ID3"				Y	Y	Y	Y	Y		

*5: Available at ROM version 0300 or later.

*10:6.00s for inverters of nominal applied motor 22kW or below; 20.0s for those of 30kW or above.

5.2 Function Codes Table

Code	Name	Data setting range	Change when running	Data copying	Factory Default	Drive control					Related page	
						V/f	PG V/f	w/PG	Torque control	PM		
		41 (1041): Low current detected	"IDL"			Y	Y	Y	Y	Y		
		42 (1042): PID alarm	"PID-ALM"			Y	Y	Y	N	Y		
		43 (1043): Under PID control	"PID-CTL"			Y	Y	Y	N	Y		
		44 (1044): Under sleep mode of PID control	"PID-STP"			Y	Y	Y	N	Y		
		45 (1045): Low torque detected	"U-TL"			Y	Y	Y	Y	Y		
		46 (1046): Torque detected 1	"TD1"			Y	Y	Y	Y	Y		
		47 (1047): Torque detected 2	"TD2"			Y	Y	Y	Y	Y		
		48 (1048): Motor 1 selected	"SWM1"			Y	Y	Y	Y	Y		
		49 (1049): Motor 2 selected	"SWM2"			Y	Y	Y	Y	Y		
		52 (1052): Running forward	"FRUN"			Y	Y	Y	Y	Y		
		53 (1053): Running reverse	"RRUN"			Y	Y	Y	Y	Y		
		54 (1054): Under remote mode	"RMT"			Y	Y	Y	Y	Y		
		56 (1056): Motor overheat detected by thermistor	"THM"			Y	Y	Y	Y	Y		
		57 (1057): Brake control	"BRKS"			Y	Y	Y	N	N		
		58 (1058): Frequency (speed) detected 3	"FDT3"			Y	Y	Y	Y	Y		
		59 (1059): Terminal [C1] (C1 function) wire break detected	"C1OFF"			Y	Y	Y	Y	Y		
		70 (1070): Speed valid *5	"DNZS"			N	Y	Y	Y	Y		
		71 (1071): Speed agreement *5	"DSAG"			N	Y	Y	N	Y		
		72 (1072): Frequency (speed) arrival 3	"FAR3"			Y	Y	Y	N	Y		
		76 (1076): PG error detected *5	"PG-ERR"			N	Y	Y	N	Y		
		77 (1077): Low DC link bus voltage detection	"U-EDC"			Y	Y	Y	Y	Y		
		79 (1079): During decelerating at momentary power failure	"IPF2"			Y	Y	Y	Y	Y		
		80 (1080): Stop position override alarm *5	"OT"			N	Y	N	N	N		
		81 (1081): Under positioning *5	"TO"			N	Y	N	N	N		
		82 (1082): Positioning completed *5	"PSET"			N	Y	Y	N	N		
		83 (1083): Current position count over-flowed *5	"POF"			N	Y	N	N	N		
		84 (1084): Maintenance timer counted up	"MNT"			Y	Y	Y	Y	Y		
		87 (1087): Frequency arrival and detected	"FARFDT"			Y	Y	Y	N	Y		
		90 (1090): Alarm content 1	"AL1"			Y	Y	Y	Y	Y		
		91 (1091): Alarm content 2	"AL2"			Y	Y	Y	Y	Y		
		92 (1092): Alarm content 4	"AL4"			Y	Y	Y	Y	Y		
		93 (1093): Alarm content 8	"AL8"			Y	Y	Y	Y	Y		
		98 (1098): Light alarm	"L-ALM"			Y	Y	Y	Y	Y		
		99 (1099): Alarm output	"ALM"			Y	Y	Y	Y	Y		
		101 (1101): EN circuit failure detected	"DECF"			Y	Y	Y	Y	Y		
		102 (1102): EN terminal input OFF	"ENOFF"			Y	Y	Y	Y	Y		
		105 (1105): Braking transistor broken	"DBAL"			Y	Y	Y	Y	Y		
		111 (1111): Customizable logic output signal 1	"CLO1"			Y	Y	Y	Y	Y		
		112 (1112): Customizable logic output signal 2	"CLO2"			Y	Y	Y	Y	Y		
		113 (1113): Customizable logic output signal 3	"CLO3"			Y	Y	Y	Y	Y		
		114 (1114): Customizable logic output signal 4	"CLO4"			Y	Y	Y	Y	Y		
		115 (1115): Customizable logic output signal 5	"CLO5"			Y	Y	Y	Y	Y		
		116 (1116): Customizable logic output signal 6	"CLO6"			Y	Y	Y	Y	Y		
		117 (1117): Customizable logic output signal 7	"CLO7"			Y	Y	Y	Y	Y		
		118 (1118): Customizable logic output signal 8	"CLO8"			Y	Y	Y	Y	Y		
		119 (1119): Customizable logic output signal 9	"CLO9"			Y	Y	Y	Y	Y		
		120 (1120): Customizable logic output signal 10	"CLO10"			Y	Y	Y	Y	Y		
		* Inside the () is written the negative logic signal setting (OFF at short-circuit)										
E29	Frequency arrival delay timer (FAR2)	0.01 to 10.00 s		Y	Y	0.10	Y	Y	Y	N	Y	5-126
E30	Frequency arrival detection width (Detection width)	0.0 to 10.0 Hz		Y	Y	2.5	Y	Y	Y	N	Y	

*5: Available at ROM version 0300 or later.

5.2 Function Codes Table

Code	Name	Data setting range	Change when running	Data copying	Factory Default	Drive control					Related page
						V/f	PG V/f	w/PG	Torque control	PM	
E31	Frequency detection 1 (Level)	0.0 to 500.0 Hz	Y	Y	200V class AJKU:60.0 400V class ACE:50.0 JKU:60.0	Y	Y	Y	N	Y	5-128
E32	(Hysteresis width)	0.0 to 500.0 Hz	Y	Y	1.0	Y	Y	Y	N	Y	
E34	Overload early warning/Current detection (Level)	0.00 (Disable), 1 to 200% of inverter rated current (Inverter rated current dependent on F80)	Y	Y1 Y2	*3	Y	Y	Y	Y	Y	5-129
E35	(Timer)	0.01 to 600.00 s	Y	Y	10.00	Y	Y	Y	Y	Y	
E36	Frequency detection 2 (Level)	0.0 to 500.0 Hz	Y	Y	200V class AJKU:60.0 400V class ACE:50.0 JKU:60.0	Y	Y	Y	Y	Y	5-130
E37	Current detection 2/ Low current detection (Level)	0.00 (Disable), 1 to 200% of inverter rated current (Inverter rated current dependent on F80)	Y	Y1 Y2	*3	Y	Y	Y	Y	Y	5-130
E38	(Timer)	0.01 to 600.00 s	Y	Y	10.00	Y	Y	Y	Y	Y	
E39	Display coefficient for transport time	0.000 to 9.999	Y	Y	0.000	Y	Y	Y	N	Y	5-130
E42	LED display filter	0.0 to 5.0 s	Y	Y	0.5	Y	Y	Y	Y	Y	5-130
E43	LED monitor (Item selection)	0: Speed monitor (Selectable with E48) 3: Output current 4: Output voltage 8: Calculated torque 9: Input power 10: PID process command 12: PID feedback value 13: Timer value(for timed operation) 14: PID output 15: Load factor 16: Motor output 17: Analog signal input monitor 21: Current position pulse *5 22: Position error pulse *5 23: Torque current (%) *5 24: Magnetic flux command(%) *5 25: Input watt-hour	Y	Y	0	Y	Y	Y	Y	Y	5-131
E44	(Display when stopped)	0: Specified value 1: Output value	Y	Y	0	Y	Y	Y	Y	Y	5-132
E48	LED monitor (Speed monitor item)	0: Output frequency 1 (before slip compensation) 1: Output frequency 2 (after slip compensation) 2: Reference frequency 3: Motor rotation speed 4: Load rotation speed 5: Line speed 6: Transport time for specified length 7: Speed (%)	Y	Y	0	Y	Y	Y	Y	Y	5-132
E49	Torque Command Monitor *5 (Polarity selection)	0: Torque polarity 1: Plus for driving, Minus for braking	Y	Y	1	Y	Y	Y	Y	Y	5-132
E50	Display coefficient for speed monitor	0.01 to 200.00	Y	Y	30.00	Y	Y	Y	Y	Y	5-133
E51	Display coefficient for "Input watt-hour data"	0.000 (Cancel/Reset). 0.001 to 9999	Y	Y	0.010	Y	Y	Y	Y	Y	5-133
E52	Keypad (Menu display mode)	0: Function code data setting mode (Menu 0, Menu1, and Menu 7) 1: Function code data check mode (Menu 2 and Menu 7) 2: Full-menu mode	Y	Y	0	Y	Y	Y	Y	Y	5-134
E54	Frequency detection 3 (Level)	0.0 to 500.0Hz	Y	Y	200V class J:50.0 AUK:60.0 400V class ACEJ:50.0 UK:60.0	Y	Y	Y	Y	Y	5-134
E55	Current detection 3 (Level)	0.00 (Disable), 1 to 200% of inverter rated current (Inverter rated current dependent on F80)	Y	Y1 Y2	*3	Y	Y	Y	Y	Y	5-134
E56	(Timer)	0.01 to 600.00 s	Y	Y	10.00	Y	Y	Y	Y	Y	

Factory default***A (For Asia), C (for China), E (for Europe), U (For USA), J (for Japan), K (for Korea)

E52 indicates quick setup target function code.

*3: The motor rated current is automatically set. Refer to "5.2.4 Motor constant" (function code P03).

*5: Available at ROM version 0300 or later.

5.2 Function Codes Table

Code	Name	Data setting range	Change when running	Data copying	Factory Default	Drive control					Related page
						V/f	PG V/f	w/PG	Torque control	PM	
E59	Terminal [C1] function selection	0: Current input (C1 function) 1: Voltage input (V2 function)	N	Y	0	Y	Y	Y	Y	Y	5-135
E61	Terminal [12] extended function	0: None	N	Y	0	Y	Y	Y	Y	Y	5-136
E62	Terminal [C1] (C1 extended function)	1: Auxiliary frequency setting 1 2: Auxiliary frequency setting 2 3: PID process command 5: PID feedback value	N	Y	0	Y	Y	Y	Y	Y	
E63	Terminal [C1] (V2 extended function)	6: Ratio setting 7: Analog torque limiter A 8: Analog torque limiter B 9: Torque bias *5 10: Torque command *5 11: Torque current command *5 17: Speed limit for forward rotation *5 18: Speed limit for reverse rotation *5 20: Analog signal input monitor	N	Y	0	Y	Y	Y	Y	Y	
E64	Saving of digital reference frequency	0: Auto saving (main power is turned off) 1: Save by turning  key ON	Y	Y	0	Y	Y	Y	Y	Y	5-136
E65	Reference loss detection	0: Stop deceleration 20 to 120%, 999: Cancel	Y	Y	999	Y	Y	Y	N	Y	5-137
E76	DC link bus low-voltage detection level	200 to 400 V (200 V class) 400 to 800 V (400 V class)	Y	Y	235 470	Y	Y	Y	Y	Y	5-137
E78	Torque detection 1 (Level)	0 to 300%	Y	Y	100	Y	Y	Y	Y	Y	5-138
E79	(Timer)	0.01 to 600.00 s	Y	Y	10.00	Y	Y	Y	Y	Y	
E80	Torque detection 2/ low torque detection (Level)	0 to 300%	Y	Y	20	Y	Y	Y	Y	Y	5-138
E81	(Timer)	0.01 to 600.00 s	Y	Y	20.00	Y	Y	Y	Y	Y	
E98	Terminal [FWD] function	0 (1000): Select multistep frequency (0 to 1 steps) "SS1"	N	Y	98	Y	Y	Y	N	Y	5-138
E99	Terminal [REV] function	1 (1001): Select multistep frequency (0 to 3 steps) "SS2"	N	Y	99	Y	Y	Y	N	Y	
		2 (1002): Select multistep frequency (0 to 7 steps) "SS4"				Y	Y	Y	N	Y	
		3 (1003): Select multistep frequency (0 to 15 steps) "SS8"				Y	Y	Y	N	Y	
		4 (1004): Select ACC/DEC time (2 steps) "RT1"				Y	Y	Y	N	Y	
		5 (1005): Select ACC/DEC time (4 steps) "RT2"				Y	Y	Y	N	Y	
		6 (1006): Select 3-wire operation "HLD"				Y	Y	Y	N	Y	
		7 (1007): Coast to a stop command "BX"				Y	Y	Y	Y	Y	
		8 (1008): Reset alarm (Abnormal) "RST"				Y	Y	Y	Y	Y	
		9 (1009): External alarm (9 = Active OFF/1009 = Active ON) "THR"				Y	Y	Y	Y	Y	
		10 (1010): Ready for jogging "JOG"				Y	Y	Y	N	N	
		11 (1011): Select frequency setting 2/ frequency setting 1 "Hz2/ Hz1"				Y	Y	Y	N	Y	
		12 (1012): Select Motor 2 "M2"				Y	Y	Y	Y	Y	
		13: DC braking command "DCBRK"				Y	Y	Y	N	N	
		14 (1014): Select torque limit 2/ torque limit 1 "TL2/ TL1"				Y	Y	Y	Y	Y	
		15: Switch to commercial power (50 Hz) "SW50"				Y	Y	N	N	N	
		16: Switch to commercial power (60 Hz) "SW60"				Y	Y	N	N	N	
		17 (1017): UP command "UP"				Y	Y	Y	N	Y	
		18 (1018): DOWN command "DOWN"				Y	Y	Y	N	Y	
		19 (1019): Allow function code editing (Data change enabled) "WE-KP"				Y	Y	Y	Y	Y	
		20 (1020): Cancel PID control "Hz/PID"				Y	Y	Y	N	Y	
		21 (1021): Switch normal/ inverse operation "IVS"				Y	Y	Y	N	Y	
		22 (1022): Interlock "IL"				Y	Y	Y	Y	Y	
		23 (1023): Cancel torque control *5 "Hz/TRQ"				N	N	N	Y	N	
		24 (1024): Select link operation (RS-485, BUS option) "LE"				Y	Y	Y	Y	Y	
		25 (1025): Universal DI "U-DI"				Y	Y	Y	Y	Y	
		26 (1026): Select auto search for idling motor speed at starting "STM"				Y	Y	N	N	Y	
		30 (1030): Force to stop (30 = Active OFF/1030 = Active ON) "STOP"				Y	Y	Y	Y	Y	
		32 (1032): Pre-excite *5 "EXITE"				N	N	Y	Y	N	

*5: Available at ROM version 0300 or later.







5.2 Function Codes Table

Code	Name	Data setting range	Change when running	Data copying	Factory Default	Drive control					Related page
						V/f	PG V/f	w/ PG	Torque control	PM	
		33 (1033): Reset PID integral and differential terms "PID-RST"				Y	Y	Y	N	Y	
		34 (1034): Hold PID integral term "PID-HLD"				Y	Y	Y	N	Y	
		35 (1035): Select local (Keypad) command "LOC"				Y	Y	Y	Y	Y	
		42 (1042): Activate the limit switch at start point *5 "LS"				Y	Y	N	N	N	
		43 (1043): Start / Reset *5 "S/R"				Y	Y	N	N	N	
		44 (1044): Switch to the serial pulse receiving mode *5 "SPRM"				Y	Y	N	N	N	
		45 (1045): Enter the return mode *5 "RTN"				Y	Y	N	N	N	
		46 (1046): Enable overload stop "OLS"				Y	Y	Y	N	Y	
		47 (1047): Servo lock command *5 "LOCK"				N	N	Y	N	N	
		49 (1049): Pulse train sign "SIGN"				Y	Y	Y	N	Y	
		59 (1059): Enable battery-driven operation *11 "BATRY/UPS"				Y	Y	Y	N	N	
		60 (1060): Select torque bias1 *5 "TB1"				N	N	Y	N	N	
		61 (1061): Select torque bias2 *5 "TB2"				N	N	Y	N	N	
		62 (1062): Hold torque bias *5 "H-TB"				N	N	Y	N	N	
		65 (1065): Check brake "BRKE"				Y	Y	Y	N	N	
		70 (1070): Cancel line speed control *5 "Hz/LSC"				Y	Y	Y	N	N	
		71 (1071): Hold line speed control frequency in the memory *5 "LSC-HLD"				Y	Y	Y	N	N	
		72 (1072): Count the run time of commercial power-driven motor 1 *5 "CRUN-M1"				Y	Y	Y	Y	N	
		73 (1073): Count the run time of commercial power-driven motor 2 *5 "CRUN-M2"				Y	Y	Y	Y	N	
		76 (1076): Select droop control "DROOP"				Y	Y	Y	N	N	
		78 (1078): Select speed control parameter 1 *5 "MPRM1"				N	Y	Y	Y	Y	
		79 (1079): Select speed control parameter 2 *5 "MPRM2"				N	Y	Y	Y	Y	
		80 (1080): Cancel customizable logic "CLC"				Y	Y	Y	Y	Y	
		81 (1081): Clear all customizable logic timers "CLTC"				Y	Y	Y	Y	Y	
		82 (1082): Cancel anti-regenerative control "AR-CCL"				Y	Y	Y	N	Y	
		98: Run forward / stop command "FWD"				Y	Y	Y	Y	Y	
		99: Run reverse / stop command "REV"				Y	Y	Y	Y	Y	
		100: No function assigned "NONE"				Y	Y	Y	Y	Y	
		171 (1171): PID control multistage command 1 "PID-SS1"				Y	Y	Y	N	Y	
		172 (1172): PID control multistage command 2 "PID-SS2"				Y	Y	Y	N	Y	
		* Inside the () is the negative logic signal. (OFF at short-circuit)									

*5: Available at ROM version 0300 or later.

*11: Available at ROM version 0500 or later.

■ C code: Control Functions of Frequency (Control function)

Code	Name	Data setting range	Change when running	Data copying	Factory Default	Drive control					Related page
						V/f	PG V/f	w/ PG	Torque control	PM	
C01	Jump frequency 1 2 3 (Skip width)	0.0 to 500.0Hz	Y	Y	0.0	Y	Y	Y	N	Y	5-139
C02			Y	Y	0.0	Y	Y	Y	N	Y	
C03			Y	Y	0.0	Y	Y	Y	N	Y	
C04		0.0 to 30.0Hz	Y	Y	3.0	Y	Y	Y	N	Y	
C05	Multistep frequency 1 2 3 4 5 6 7 8 9 10 11 12 13 14 15	0.00 to 500.00Hz	Y	Y	0.00	Y	Y	Y	N	Y	5-140
C06			Y	Y	0.00	Y	Y	Y	N	Y	
C07			Y	Y	0.00	Y	Y	Y	N	Y	
C08			Y	Y	0.00	Y	Y	Y	N	Y	
C09			Y	Y	0.00	Y	Y	Y	N	Y	
C10			Y	Y	0.00	Y	Y	Y	N	Y	
C11			Y	Y	0.00	Y	Y	Y	N	Y	
C12			Y	Y	0.00	Y	Y	Y	N	Y	
C13			Y	Y	0.00	Y	Y	Y	N	Y	
C14			Y	Y	0.00	Y	Y	Y	N	Y	
C15			Y	Y	0.00	Y	Y	Y	N	Y	
C16			Y	Y	0.00	Y	Y	Y	N	Y	
C17			Y	Y	0.00	Y	Y	Y	N	Y	
C18			Y	Y	0.00	Y	Y	Y	N	Y	
C19			Y	Y	0.00	Y	Y	Y	N	Y	
C20	Jogging frequency	0.00 to 500.00 Hz	Y	Y	0.00	Y	Y	Y	N	N	5-140
C21	Pattern operation / timed operation (Mode selection) (Stage 1) (Stage 2) (Stage 3) (Stage 4) (Stage 5) (Stage 6) (Stage 7)	0: 1 cycle operation 1: Repetition operation 2: Constant speed operation after 1 cycle operation 3: Timed operation Special setting: Press  key three times. 1st: Set run time 0.0 to 6000 s and press  key. 2nd: Set rotational direction F (forward) or r (reverse) and press  key. 3rd: Set acceleration/deceleration time 1 to 4 and press  key.	N	Y	0	Y	Y	Y	N	Y	5-141
C22			Y	Y	1st: 0.00	Y	Y	Y	N	Y	
C23			Y	Y	2nd: F	Y	Y	Y	N	Y	
C24			Y	Y	3rd: 1	Y	Y	Y	N	Y	
C25			Y	Y		Y	Y	Y	N	Y	
C26			Y	Y		Y	Y	Y	N	Y	
C27			Y	Y		Y	Y	Y	N	Y	
C28			Y	Y		Y	Y	Y	N	Y	
C30	Frequency setting 2	0: Keypad  key operation 1: Analog voltage input (Terminal [12]) (from 0 to ±10 VDC) 2: Analog current input (Terminal [C1] (C1 function)) (4 to 20 mA DC, 0 to 20 mA DC) 3: Analog voltage input (Terminal [12]) + Analog current input (Terminal [C1] (C1 function)) 5: Analog voltage input (Terminal [C1] (V2 function)) (0 to 10 VDC) 7: UP DOWN control 8: Keypad key operation ( key) (With balanceless bumpless) 10: Pattern operation 11: Digital input/output interface card (option) *5 12: Pulse train input	N	Y	2	Y	Y	Y	N	Y	5-143
C31	Analog input adjustment (Terminal [12]) (Offset) (Gain) (Filter) (Gain base point) (Polarity selection)	-5.0 to 5.0%	Y*	Y	0.0	Y	Y	Y	Y	Y	5-144
C32		0.00 to 200.00%	Y*	Y	100.0	Y	Y	Y	Y	Y	
C33		0.00 to 5.00 s	Y	Y	0.05	Y	Y	Y	Y	Y	
C34		0.00 to 100.00%	Y*	Y	100.0	Y	Y	Y	Y	Y	
C35		0: Bipolar 1: Unipolar	N	Y	1	Y	Y	Y	Y	Y	
C36	Analog input adjustment (Terminal [C1] (C1 function)) (Offset) (Gain) (Filter) (Gain base point)	-5.0 to 5.0%	Y*	Y	0.0	Y	Y	Y	Y	Y	
C37		0.00 to 200.00%	Y*	Y	100.0	Y	Y	Y	Y	Y	
C38		0.00 to 5.00 s	Y	Y	0.05	Y	Y	Y	Y	Y	
C39		0.00 to 100.00%	Y*	Y	100.0	Y	Y	Y	Y	Y	
C40	Terminal [C1] (C1 function) range / polarity selection	0: 4 to 20 mA Unipolar 1: 0 to 20 mA Unipolar 10: 4 to 20 mA Bipolar 11: 0 to 20 mA Bipolar	N	Y	0	Y	Y	Y	Y	Y	

*5: Available at ROM version 0300 or later.

5.2 Function Codes Table

Code	Name	Data setting range	Change when running	Data copying	Factory Default	Drive control					Related page
						V/f	PG V/f	w/ PG	Torque control	PM	
C41	Analog input adjustment (Terminal [C1] (V2 function)) (Offset)	-5.0 to 5.0%	Y*	Y	0.0	Y	Y	Y	Y	Y	
C42	(Gain)	0.00 to 200.00%	Y*	Y	100.0	Y	Y	Y	Y	Y	
C43	(Filter)	0.00 to 5.00 s	Y	Y	0.05	Y	Y	Y	Y	Y	
C44	(Gain base point)	0.00 to 100.00%	Y*	Y	100.0	Y	Y	Y	Y	Y	
C45	(Polarity selection)	0: Bipolar 1: Unipolar	N	Y	1	Y	Y	Y	Y	Y	
C50	Bias (for frequency setting 1) (Bias base point)	0.00 to 100.00%	Y*	Y	0.00	Y	Y	Y	N	Y	5-146
C53	Selection of normal/inverse operation (Frequency setting 1)	0: Normal 1: Inverse	Y	Y	0	Y	Y	Y	N	Y	5-146
C55	Analog input adjustment (Terminal 12) (Bias)	-100.00 to 100.00%	Y	Y	0.00	Y	Y	Y	Y	Y	5-144
C56	(Bias base point)	0.00 to 100.00 %	Y	Y	0.00	Y	Y	Y	Y	Y	
C58	(Display unit)	* Same as J105 (However, setting range is, 1 to 80)	Y	Y	2	Y	Y	Y	Y	Y	5-147
C59	(Maximum scale)	-999.00 to 0.00 to 9990.00	N	Y	100	Y	Y	Y	Y	Y	5-147
C60	(Minimum scale)	-999.00 to 0.00 to 9990.00	N	Y	0.00	Y	Y	Y	Y	Y	
C61	Analog input adjustment (Terminal[C1](C1 function)) (Bias)	-100.00 to 100.00 %	Y	Y	0.00	Y	Y	Y	Y	Y	5-144
C62	(Bias base point)	0.00 to 100.00 %	Y	Y	0.00	Y	Y	Y	Y	Y	
C64	(Display unit)	* Same as J105 (However, setting range is, 1 to 80)	Y	Y	2	Y	Y	Y	Y	Y	5-147
C65	(Maximum scale)	-999.00 to 0.00 to 9990.00	N	Y	100	Y	Y	Y	Y	Y	5-147
C66	(Minimum scale)	-999.00 to 0.00 to 9990.00	N	Y	0.00	Y	Y	Y	Y	Y	
C67	Analog input adjustment (Terminal [C1] (V2 function)) (Bias)	-100.00 to 100.00 %	Y	Y	0.00	Y	Y	Y	Y	Y	5-144
C68	(Bias base point)	0.00 to 100.00 %	Y	Y	0.00	Y	Y	Y	Y	Y	
C70	(Display unit)	* Same as J105 (However, setting range is, 1 to 80)	Y	Y	2	Y	Y	Y	Y	Y	5-147
C71	(Maximum scale)	-999.00 to 0.00 to 9990.00	N	Y	100	Y	Y	Y	Y	Y	5-147
C72	(Minimum scale)	-999.00 to 0.00 to 9990.00	N	Y	0.00	Y	Y	Y	Y	Y	
C89	Frequency correction 1 by (Numerator)	-32768 to 32767 (Keypad display is 8000 to 7FFFH) (Interpreted as 1 when the value is set to 0)	Y	Y	0001	Y	Y	Y	N	Y	—
C90	Frequency correction 2 by (Denominator)	-32768 to 32767 (Keypad display is 8000 to 7FFFH) (Interpreted as 1 when the value is set to 0)	Y	Y	0001	Y	Y	Y	N	Y	—

■ P codes: Motor 1 Parameters (Motor 1 parameter)

Code	Name	Data setting range	Change when running	Data copying	Factory Default	Drive control					Related page
						V/f	PG V/f	w/ PG	Torque control	PM	
P01	Motor 1 (No. of poles)	2 to 22 poles	N	Y1 Y2	4	Y	Y	Y	Y	Y	5-148
P02	(Rated capacity)	0.01 to 1000 kW (At P99 = 0 or 4, 15) 0.01 to 1000 HP (At P99 = 1)	N	Y1 Y2	*6	Y	Y	Y	Y	Y	5-148
P03	(Rated current)	0.00 to 2000A	N	Y1 Y2	*6	Y	Y	Y	Y	Y	5-148
P04	(Auto-tuning)	0: Disable 1: Stop tuning 2: Rotation tuning 5: Stop tuning(%R1, %X) *5	N	N	0	Y	Y	Y	Y	Y	5-149
P05	(Online tuning)	0: Invalid 1: Valid	Y	Y	0	Y	Y	N	N	N	5-150
P06	(No-load current)	0.00 to 2000A	N	Y1 Y2	*6	Y	Y	Y	Y	N	5-151
P07	(%R1)	0.00 to 50.00%	Y	Y1 Y2	*6	Y	Y	Y	Y	N	
P08	(%X)	0.00 to 50.00%	Y	Y1 Y2	*6	Y	Y	Y	Y	N	
P09	(Slip compensation gain for driving)	0.0 to 200.0%	Y*	Y	100.0	Y	Y	Y	N	N	5-151
P10	(Slip compensation response time)	0.01 to 10.00 s	Y	Y1 Y2	0.5	Y	Y	N	N	N	
P11	(Slip compensation gain for braking)	0.0 to 200.0 %	Y*	Y	100.0	Y	Y	Y	N	N	
P12	(Rated slip frequency)	0.00 to 15.00 Hz	N	Y1 Y2	*6	Y	Y	Y	N	N	5-152
P13	(Iron loss factor 1)	0.00 to 20.00 %	Y	Y1 Y2	*6	Y	Y	Y	Y	N	5-152
P16	(Magnetic saturation factor 1) *5	0.0 to 300.0 %	Y	Y1 Y2	*6	N	N	Y	Y	N	5-152
P17	(Magnetic saturation factor 2) *5	0.0 to 300.0 %	Y	Y1 Y2	*6	N	N	Y	Y	N	
P18	(Magnetic saturation factor 3) *5	0.0 to 300.0 %	Y	Y1 Y2	*6	N	N	Y	Y	N	
P19	(Magnetic saturation factor 4) *5	0.0 to 300.0 %	Y	Y1 Y2	*6	N	N	Y	Y	N	
P20	(Magnetic saturation factor 5) *5	0.0 to 300.0 %	Y	Y1 Y2	*6	N	N	Y	Y	N	
P30	(PMSM drive magnetic pole position detection mode) *5	0: Pull-in by current 1: For IPMSM (Interior permanent magnet synchronous motor) 2: For SPMSM (Surface permanent magnet synchronous motor) 3: Pull-in by current for IPMSM (Interior permanent magnet synchronous motor)	N	Y1 Y2	1	N	N	N	N	Y	5-153
P53	(%X correction factor 1) *5	0 to 300 %	Y	Y1 Y2	100	Y	Y	Y	Y	N	5-153
P55	(Torque current under vector control) *5	0.00 to 2000 A	N	Y1 Y2	*6	N	N	Y	Y	N	5-153
P56	(Induced voltage factor under vector control) *5	50 to 100 %	N	Y1 Y2	*6	N	N	Y	Y	N	
P60	(PMSM armature resistance)*5	0.000 to 50.000 ohm	N	Y1 Y2	*7	N	N	N	N	Y	5-153
P61	(PMSM d-axis inductance)*5	0.00 to 500.00 mH	N	Y1 Y2	*7	N	N	N	N	Y	
P62	(PMSM q-axis inductance)*5	0.00 to 500.00 mH	N	Y1 Y2	*7	N	N	N	N	Y	
P63	(PMSM induced voltage)*5	80 to 240V (200V class); 160 to 500V (400Vclass)	N	Y1 Y2	*7	N	N	N	N	Y	
P64	(PMSM iron loss)*5	0.0 to 20.0 %	Y	Y1 Y2	*7	N	N	N	N	Y	
P65	(PMSM d-axis inductance magnetic saturation correction)*5 *9	0.0 to 100.0 % ; 999	Y	Y1 Y2	*7	N	N	N	N	Y	5-154

■ indicates quick setup target function code.

*5: Available at ROM version 0300 or later.

*6: Factory defaults are depended on motor capacity. Refer to "5.2.4 Motor constant".

*7: Factory defaults are the parameters for Fuji standard PMSM and depended on motor capacity.

*9: Factory use. Do not access these function codes.

5.2 Function Codes Table

Code	Name	Data setting range	Change when running	Data copying	Factory Default	Drive control					Related page
						V/f	PG V/f	w/ PG	Torque control	PM	
P74	(PMSM reference current at starting)*5	10 to 200 % (100%= motor rated current)	Y*	Y1 Y2	*7	N	N	N	N	Y	5-154
P83	(Reserved for PMSM)*5 *9	0.0 to 50.0; 999	Y	Y1 Y2	999	N	N	N	N	-	5-154
P84	(Reserved for PMSM)*5 *9	0.0 to 100.0; 999	N	Y1 Y2	999	N	N	N	N	-	
P85	(PMSM flux limitation value)	50.0 to 150.0; 999	Y	Y1 Y2	999	N	N	N	N	Y	5-154
P86	(Reserved for PMSM)	0 to 100.0%	N	N	0.0	N	N	N	N	-	5-154
P87	(PMSM reference current for polarity discrimination)	0 to 200 %	N	Y1 Y2	60	N	N	N	N	Y	-
P88	(Reserved for PMSM)*5 *9	0 to 100 %; 999	N	Y1 Y2	999	N	N	N	N	-	5-154
P89	(Reserved for PMSM)*5 *9	0; 1 to 100	N	Y1 Y2	0	N	N	N	N	-	
P90	(PMSM overcurrent protection level)*5	0.00(disable); 0.01 to 2000 A	N	Y1 Y2	*7	N	N	N	N	Y	5-154
P99	Motor 1 selection	0: Motor characteristics 0 (Fuji standard IM, 8-series) 1: Motor characteristics 1 (HP rating IMs) 4: Other IMs 20: Other motors(PMSMs) *5 21: Motor characteristics (Fuji PMSM GNB2 series) *5	N	Y1 Y2	U:1 ACEJK:0	Y	Y	Y	Y	Y	5-154

P99 indicates quick setup target function code.

Factory default**A (For Asia), C (for China), E (for Europe), U (For USA), J (for Japan), K (for Korea)

*5: Available at ROM version 0300 or later.

*7: Factory defaults are the parameters for Fuji standard PMSM and depended on motor capacity.

*9: Factory use. Do not access these function codes.

■ H codes: High Performance Functions (High level function)

Code	Name	Data setting range	Change when running	Data copying	Factory Default	Drive control					Related page
						V/f	PG V/f	w/ PG	Torque control	PM	
H02	Data initialization (Method)	0: Standard 1: User	N	Y	0	Y	Y	Y	Y	Y	5-155
H03	(Target)	0: Manual setting value 1: Initial value (factory default value) 2: Initialize motor 1 parameters 3: Initialize motor 2 parameters 11: Initialize the parameters(excluding parameters related to communication) 12: Initialize the parameters related to customizable logic	N	N	0	Y	Y	Y	Y	Y	
H04	Auto-reset (Times)	0: Disable, 1 to 20: Number of retries	Y	Y	0	Y	Y	Y	Y	Y	5-157
H05	(Interval)	0.5 to 20.0 s	Y	Y	5.0	Y	Y	Y	Y	Y	
H06	Cooling fan ON/OFF control	0: Disable (Always Fan ON) 1: Enable (ON/OFF control effective)	Y	Y	0	Y	Y	Y	Y	Y	5-158
H07	Curve acceleration/ deceleration	0: Disable (Linear acceleration/deceleration) 1: S-curve acceleration/deceleration (Weak) 2: S-curve acceleration/deceleration (Arbitrary: According to H57 to H60) 3: Curve acceleration/deceleration	Y	Y	0	Y	Y	Y	N	Y	5-158
H08	Rotational direction limitation	0: Disable 1: Enable (Reverse rotation inhibited) 2: Enable (Forward rotation inhibited)	N	Y	0	Y	Y	Y	N	Y	5-158
H09	Starting mode (Auto search)	0: Disable 1: Enable (Only at restart after momentary power failure) 2: Enable (At normal start and at restart after momentary power failure)	N	Y	0	Y	Y	N	N	N	5-159
H11	Deceleration mode	0: Normal deceleration 1: Coast to a stop	Y	Y	0	Y	Y	Y	N	Y	5-161
H12	Instantaneous overcurrent limiting (Mode selection)	0: Disable 1: Enable	Y	Y	1	Y	Y	N	N	N	5-161
H13	Restart mode after momentary power failure (Restart timer)	0.1 to 20.0 s	Y	Y1 Y2	*2	Y	Y	Y	N	N	5-161
H14	(Frequency fall rate)	0.00: Selected deceleration time, 0.01 to 100.00Hz/s, 999 (According to current limiter)	Y	Y	999	Y	Y	N	N	N	
H15	(Continuous running level)	200 to 300V: (200 V class) 400 to 600V: (400V class)	Y	Y2	235 470	Y	Y	Y	N	Y	
H16	(Allowable momentary power failure time)	0.0 to 30.0s, 999 (Depend on inverter judgment)	Y	Y	999	Y	Y	Y	N	Y	
H18	Torque control *5 (Mode selection)	0: Disable (Speed control) 2: Function (Torque current command) 3: Function (Torque command)	N	Y	0	N	N	Y	Y	N	5-162
H26	Thermistor (for motor) (Mode selection)	0: Disable 1: PTC: $\frac{1}{\theta}$ trip and stop the inverter 2: PTC: Output motor overheat detected "THM" and continue to run	Y	Y	0	Y	Y	Y	Y	Y	5-164
H27	(Level)	0.00 to 5.00 V	Y	Y	1.60	Y	Y	Y	Y	Y	
H28	Droop control	-60.0 to 0.0Hz	Y	Y	0.0	Y	Y	Y	N	N	5-166
H30	Communication link function (Mode selection)	Frequency command Run command 0: F01/C30 F02 1: RS-485 (Port 1) F02 2: F01/C30 RS-485 (Port 1) 3: RS-485 (Port 1) RS-485 (Port 1) 4: RS-485 (Port 2) F02 5: RS-485 (Port 2) RS-485 (Port 1) 6: F01/C30 RS-485 (Port 2) 7: RS-485 (Port 1) RS-485 (Port 2) 8: RS-485 (Port 2) RS-485 (Port 2)	Y	Y	0	Y	Y	Y	Y	Y	5-167
H42	Capacitance of DC link bus capacitor	For adjustment at replacement (0000 to FFFF (in hexadecimal))	Y	N	-	Y	Y	Y	Y	Y	5-169
H43	Cumulative run time of cooling fan	For adjustment at replacement Displays the cumulative run time of cooling fan in units of ten hours.	Y	N	-	Y	Y	Y	Y	Y	
H44	Startup count for motor 1	For adjustment at replacement (0000 to FFFF in hexadecimal)	Y	N	-	Y	Y	Y	Y	Y	5-173
H45	Mock alarm	0: Disable 1: Occurrence of mock Alarm	Y	N	0	Y	Y	Y	Y	Y	5-173
H46	Starting mode (Auto search delay time 2)	0.1 to 20.0 s	Y	Y1 Y2	*6	Y	Y	N	N	Y	5-173

*2: Factory defaults are depended on motor capacity. Refer to "5.2.3 Factory default value per applicable electric motor capacitance".
 *5: Available at ROM version 0300 or later.
 *6: Factory defaults are depended on motor capacity. Refer to "5.2.4 Motor constant".

5.2 Function Codes Table

Code	Name	Data setting range	Change when running	Data copying	Factory Default	Drive control					Related page
						V/f	PG V/f	w/PG	Torque control	PM	
H47	Initial capacitance of DC link bus capacitor	For adjustment at replacement (0000 to FFFF in hexadecimal)	Y	N	-	Y	Y	Y	Y	Y	5-173
H48	Cumulative run time of capacitors on printed circuit boards	For adjustment at replacement Change in cumulative motor run time (Reset is enabled) (in units of ten hours)	Y	N	-	Y	Y	Y	Y	Y	5-169 5-173
H49	Starting mode (Auto search delay time 1)	0.0 to 10.0 s	Y	Y	0.0	Y	Y	Y	N	Y	5-174
H50	Non-linear V/f 1 (Frequency)	0.0 (Cancel), 0.1 to 500.0 Hz	N	Y	0.0	Y	Y	N	N	N	5-174
H51	(Voltage)	0 to 240 V:AVR operation (200 V class) 0 to 500V:AVR operation (400V class)	N	Y2	0	Y	Y	N	N	N	
H52	Non-linear V/f 2 (Frequency)	0.0 (Cancel), 0.1 to 500.0 Hz	N	Y	0.0	Y	Y	N	N	N	5-174
H53	(Voltage)	0 to 240V:AVR operation (200V class) 0 to 500V:AVR operation (400V class)	N	Y2	0	Y	Y	N	N	N	
H54	Acceleration time (Jogging)	0.00 to 6000 s	Y	Y	6.00 or 20.0 *10	Y	Y	Y	N	Y	5-174
H55	Deceleration time (Jogging)	0.00 to 6000 s	Y	Y		Y	Y	Y	N	Y	
H56	Deceleration time for forced stop	0.00 to 6000 s	Y	Y		Y	Y	Y	N	Y	
H57	1st S-curve acceleration range (At starting)	0 to 100%	Y	Y	10	Y	Y	Y	N	Y	
H58	2nd S-curve acceleration range (At arrival)	0 to 100%	Y	Y	10	Y	Y	Y	N	Y	
H59	1st S-curve deceleration range (At starting)	0 to 100%	Y	Y	10	Y	Y	Y	N	Y	
H60	2nd S-curve deceleration range (At arrival)	0 to 100%	Y	Y	10	Y	Y	Y	N	Y	
H61	UP/DOWN control (Initial frequency setting)	0: Initial value is 0.00 Hz 1: Last UP/DOWN command value on releasing the run command.	N	Y	1	Y	Y	Y	N	Y	5-174
H63	Low limiter (Mode selection)	0: Limit by F16 (Frequency limiter: Low) and continue to run 1: If the output frequency lowers below the one limited by F16 (Frequency limiter: Low), decelerate to stop the motor.	Y	Y	0	Y	Y	Y	N	Y	5-174
H64	(Lower limiting frequency)	0.0: Depends on F16 (Frequency limiter, Low) 0.1 to 60.0 Hz	Y	Y	1.6	Y	Y	N	N	Y	5-174
H65	Non-linear V/f 3 (Frequency)	0.0 (Cancel), 0.1 to 500.0 Hz	N	Y	0.0	Y	Y	N	N	N	5-174
H66	(Voltage)	0 to 240V: AVR operation (200V class) 0 to 500V: AVR operation (400V class)	N	Y2	0	Y	Y	N	N	N	
H68	Slip compensation 1 (Operating conditions selection)	0: Enable during acceleration/deceleration, enable at base frequency or higher 1: Disable during acceleration/deceleration, enable at base frequency or higher 2: Enable during acceleration/deceleration, disable at base frequency or higher 3: Disable during acceleration/deceleration, disable at base frequency or higher	N	Y	0	Y	Y	N	N	N	5-174
H69	Anti-regenerative control (Mode selection)	0: Disable 2: Torque limit control with force-to-stop (Cancel limit control after three times of deceleration time has passed) 3: DC link bus voltage control with force-to-stop (Cancel voltage control after three times of deceleration time has passed) 4: Torque limit control without force-to-stop 5: DC link bus voltage control without force-to-stop	Y	Y	0	Y	Y	Y	N	Y	5-175
H70	Overload prevention control	0.00: Follow the deceleration time selected 0.01 to 100.00 Hz/s, 999 (Cancel)	Y	Y	999	Y	Y	Y	N	Y	5-176
H71	Deceleration characteristics	0: Disable 1: Enable	Y	Y	0	Y	Y	Y	N	N	5-176
H72	Main power shutdown detection (Mode selection)	0: Disable 1: Enable (Available FRN0088E2■-2□/FRN0059E2■-4□ or above)	Y	Y	1	Y	Y	Y	Y	Y	5-176
H74	Torque limiter *5 (Control target)	0: Torque limit 1: Torque current limit	N	Y	1	N	N	Y	Y	Y	5-177
H76	Torque limiter (Braking) (Frequency rising limiter for braking)	0.0 to 500.0Hz	Y	Y	5.0	Y	Y	N	N	N	5-177
H77	Service life of DC link bus capacitor	0 to 8760 (in units of ten hours)	Y	N	6132 (ND spec)	Y	Y	Y	Y	Y	5-177

*5: Available at ROM version 0300 or later.

*10:6.00s for inverters of nominal applied motor 22kW or below; 20.0s for those of 30kW or above.

5.2 Function Codes Table

Code	Name	Data setting range	Change when running	Data copying	Factory Default	Drive control					Related page
						V/f	PG V/f	w/ PG	Torque control	PM	
H78	Maintenance interval (M1)	0 (Disable): 1 to 9999 (in units of ten hours)	Y	N	6132 (ND spec)	Y	Y	Y	Y	Y	5-177
H79	Preset startup count for maintenance (M1)	0000 (Disable): 0001 to FFFF (in hexadecimal)	Y	N	0	Y	Y	Y	Y	Y	5-178
H80	Output current fluctuation damping gain for motor 1	0.00 to 1.00	Y	Y	0.20	Y	Y	N	N	N	5-178
H81	Light alarm selection 1	0000 to FFFF (in hexadecimal)	Y	Y	0	Y	Y	Y	Y	Y	5-179
H82	Light alarm selection 2	0000 to FFFF (in hexadecimal)	Y	Y	0	Y	Y	Y	Y	Y	
H84	Pre-excitation *5 (Level)	100 to 400 % (Motor rated magnetizing current for 100%)	Y	Y	100	N	N	Y	Y	N	5-181
H85	(Timer)	0.00; 0.01 to 30.00 s 0.00; Invalid 0.01 to 30.00 s	Y	Y	0.00	N	N	Y	Y	N	
H86	Reserved *9	0 to 2	Y	Y	0	-	-	-	-	-	5-183
H89	Reserved *9	0 to 1	Y	Y	1	-	-	-	-	-	5-183
H90	Reserved *9	0 to 1	Y	Y	0	-	-	-	-	-	5-183
H91	PID feedback wire break detection	0.0 (Alarm disable): 0.1 to 60.0 s	Y	Y	0.0	Y	Y	Y	N	Y	5-183
H92	Continuous running at the momentary power failure (P)	0.000 to 10.000 times; 999 999:Manufacturer adjustment value	Y	Y1 Y2	999	Y	Y	Y	N	Y	5-183
H93	(I)	0.010 to 10.000 s; 999 999:Manufacturer adjustment value	Y	Y1 Y2	999	Y	Y	Y	N	Y	
H94	Cumulative motor run time 1	0 to 9999 Change in cumulative motor run time (Reset is enabled) (in units of 10 hours)	N	N	-	Y	Y	Y	Y	Y	5-177 5-183
H95	DC braking (Braking response mode)	0: Slow response 1: Quick response	Y	Y	1	Y	Y	N	N	N	5-74 5-183
H96	STOP key priority/ Start check function	0: STOP key priority disable/ Start check function disable 1: STOP key priority enable/ Start check function disable 2: STOP key priority disable/ Start check function enable 3: STOP key priority enable/ Start check function enable	Y	Y	U:3 ACEJK:0	Y	Y	Y	Y	Y	5-184
H97	Clear alarm data	0: Disable 1: Alarm data clear (Automatically return to 0 after clearing data)	Y	N	0	Y	Y	Y	Y	Y	5-184
H98	Protection/Maintenance function (Mode selection)	0 to 127 (Data is displayed in decimal) Bit 0: Lower the carrier frequency automatically (0: Disable; 1: Enable) Bit 1: Input phase loss protection (0: Disable; 1: Enable) Bit 2: Output phase loss protection (0: Disable; 1: Enable) Bit 3: Main circuit capacitor life judgment selection (0: Factory default referenced; 1 User measurement value standard) Bit 4: Judge the life of main circuit capacitor (0: Disable; 1: Enable) Bit 5: Detect DC fan lock (0: Enable; 1: Disable) Bit 6: Braking transistor error detection (0: Disable; 1: Enable)	Y	Y	*11	Y	Y	Y	Y	Y	5-185
H99	Password 2 setting/check	0000 to FFFF (Hexadecimal)	Y	N	0	Y	Y	Y	Y	Y	5-187
H101	Destination	0: Not selected 1: Japan 2: Asia 3: China 4: Europe 5: Americas 7: Korea	N	Y	G(AEU):0 J:1 C:3 K:7	Y	Y	Y	Y	Y	5-190
H111	UPS operation level	120 to 220 VDC: (200 V class) 240 to 440 VDC: (400 V class)	Y	Y2	220 440	Y	Y	Y	N	N	5-190
H114	Anti-regenerative control (Level)	0.0 to 50.0%, 999: disabled	Y	Y	999	Y	Y	Y	N	Y	5-190
H147	Speed control (Jogging) FF (Gain) *5	0.00 to 99.99 s	Y*	Y	0.00	N	N	Y	N	N	5-190 5-230

Factory default...A (For Asia), C (for China), E (for Europe), U (For USA), J (for Japan), K (for Korea)

*5: Available at ROM version 0300 or later.

*9: Factory use. Do not access these function codes.

*11:FRN0115E2-2 or below: 83, FRN0072E2-4 or below: 83, FRN0012E2-7 or below: 83, FRN0085E2-4 or above: 19.

5.2 Function Codes Table

Code	Name	Data setting range	Change when running	Data copying	Factory Default	Drive control					Related page
						V/f	PG V/f	w/PG	Torque control	PM	
H154	Torque bias (Mode selection) *5	0: Invalid 1: Digital torque bias 2: Analog torque bias	N	Y	0	N	N	Y	N	N	5-190
H155	(Level 1)	-300 to +300 %	N	Y	0	N	N	Y	N	N	
H156	(Level 2)	-300 to +300 %	N	Y	0	N	N	Y	N	N	
H157	(Level 3)	-300 to +300 %	N	Y	0	N	N	Y	N	N	
H158	(Mechanical loss compensation)	0 to 300 %	N	Y	0	N	N	Y	N	N	
H159	(Startup timer)	0.00 to 1.00 s	N	Y	0.00	N	N	Y	N	N	
H161	(Shutdown timer)	0.00 to 1.00 s	N	Y	0.00	N	N	Y	N	N	
H162	(Limiter)	0 to 300 %	N	Y	200	N	N	Y	N	N	
H173	Magnetic flux level at light load *5	10 to 100 %	Y	Y	100	N	N	Y	Y	N	5-192
H180	Brake control signal (Check-timer for brake operation)	0.00 to 10.00 s	Y	Y	0.00	Y	Y	Y	N	N	5-192
H193	User initial value (Save)	0: Disable, 1: Save	Y	N	0	Y	Y	Y	Y	Y	5-156
H194	(Protection)	0: Save enable, 1: Protected (Save disable)	Y	Y	0	Y	Y	Y	Y	Y	
H195	DC braking (Braking timer at the startup)	0.00 (Disable): 0.01 to 30.00 s	Y	Y	0.00	Y	Y	N	N	N	5-74 5-192
H196	Reserved *5 *9	0.001 to 9.999, 999	Y	Y	999	Y	Y	N	N	N	—
H197	User password 1 (Selection of protective operation)	0: All function codes are disclosed, but the change is not allowed. 1: Only the function code for quick setup can be disclosed/changed. 2: Only the function code for customize logic setting is not disclosed/not changed.	Y	Y	0	Y	Y	Y	Y	Y	5-187
H198	(Setting/check)	0000 to FFFF (Hexadecimal)	Y	N	0	Y	Y	Y	Y	Y	
H199	User password protection valid	0: Disable 1: Protected	Y	N	0	Y	Y	Y	Y	Y	

*5: Available at ROM version 0300 or later.

*9: Factory use. Do not access these function codes.

■ A codes: Motor 2 Parameters (Motor 2 parameters)

Code	Name	Data setting range	Change when running	Data copying	Factory Default	Drive control					Related page
						V/f	PG V/f	w/ PG	Torque control	PM	
A01	Maximum output frequency 2	25.0 to 500.0Hz	N	Y	200V class AJKU:60.0 400V class ACE:50.0 JKU:60.0	Y	Y	Y	Y	N	-
A02	Base frequency 2	25.0 to 500.0Hz	N	Y	200V class J:50.0 AUK:60.0 400V class ACEJ:50.0 UK:60.0	Y	Y	Y	Y	N	
A03	Rated voltage at base frequency 2	0: AVR disable (output voltage proportional to power voltage) 80 to 240V: AVR operation (200V class) 160 to 500V: AVR operation (400V class)	N	Y2	200V class J:200 AK:220 U:230	Y	Y	Y	Y	N	
A04	Maximum output voltage 2	80 to 240V: AVR operation (200V class) 160 to 500V: AVR operation (400V class)	N	Y2	400V class EJ:400 A:415 CK:380 U:460	Y	Y	N	Y	N	
A05	Torque boost 2	0.0 to 20.0% (% value against base frequency voltage 2)	Y	Y	*2	Y	Y	N	N	N	
A06	Electronic thermal overload protection for motor 2 (Select motor characteristics)	1: Enable (For a general-purpose motor with self-cooling fan) 2: Enable (For an inverter-driven motor with separately powered cooling fan)	Y	Y	1	Y	Y	Y	Y	N	
A07	(Overload detection level)	0.00 (disable), current value of 1 to 135% of inverter rated current	Y	Y1 Y2	*3	Y	Y	Y	Y	N	
A08	(Thermal time constant)	0.5 to 75.0 min	Y	Y	*4	Y	Y	Y	Y	N	
A09	DC braking 2 (Braking starting frequency)	0.0 to 60.0Hz	Y	Y	0.0	Y	Y	Y	N	N	
A10	(Braking level)	0 to 100% (HHD mode), 0 to 80% (HD/HND mode) 0 to 60% (ND mode)	Y	Y	0	Y	Y	Y	N	N	
A11	(Braking time)	0.00 (Disable): 0.01 to 30.00 s	Y	Y	0.00	Y	Y	Y	N	N	
A12	Starting frequency 2	0.0 to 60.0Hz	Y	Y	0.5	Y	Y	Y	N	N	
A13	Load selection / Auto torque boost/ Auto energy-saving operation 2	0: Variable torque load 1: Constant torque load 2: Auto torque boost 3: Auto energy-saving operation (variable torque load) 4: Auto energy-saving operation (constant torque load) 5: Auto energy-saving operation with auto torque boost	N	Y	1	Y	Y	Y	N	N	
A14	Drive control selection 2	0: V/f control without slip compensation 1: Vector control without speed sensor (Dynamic torque vector control) 2: V/f control with slip compensation 3: V/f control with speed sensor 4: V/f control with speed sensor and auto torque boost 6: Vector control for induction motor with speed sensor	N	Y	0	Y	Y	Y	Y	N	
A15	Motor 2 (No. of poles)	2 to 22 poles	N	Y1 Y2	4	Y	Y	Y	Y	N	
A16	(Rated capacity)	0.01 to 1000 kW (At P39 = 0, 4) 0.01 to 1000 HP (At P39 = 1)	N	Y1 Y2	*6	Y	Y	Y	Y	N	
A17	(Rated current)	0.00 to 2000A	N	Y1 Y2	*6	Y	Y	Y	Y	N	
A18	(Auto-tuning)	0: Disable 1: Stop tuning 2: Rotation tuning 5: Stop tuning (%R1, %X)	N	N	0	Y	Y	Y	Y	N	
A19	(Online tuning)	0: Invalid 1:Valid	Y	Y	0	Y	N	N	N	N	
A20	(No-load current)	0.00 to 2000A	N	Y1 Y2	*6	Y	Y	Y	Y	N	
A21	(%R1)	0.00 to 50.00%	Y	Y1 Y2	*6	Y	Y	Y	Y	N	
A22	(%X)	0.00 to 50.00%	Y	Y1 Y2	*6	Y	Y	Y	Y	N	

Factory default***A (For Asia), C (for China), E (for Europe), U (For USA), J (for Japan), K (for Korea)
 *2: Factory defaults are depended on motor capacity. Refer to "5.2.3 Factory default value per applicable electric motor capacitance".
 *3: The motor rated current is automatically set. Refer to "5.2.4 Motor constant" (function code P03).
 *4: Standard applicable electric motor is 5.0 min for 22 kW or lower and 10.0 min for 30 kW or higher.
 *6: Factory defaults are depended on motor capacity. Refer to "5.2.4 Motor constant".

5.2 Function Codes Table

Code	Name	Data setting range	Change when running	Data copying	Factory Default	Drive control					Related page
						V/f	PG V/f	w/PG	Torque control	PM	
A23	Motor 2 (Slip compensation gain for driving)	0.0 to 200.0%	Y*	Y	100.0	Y	Y	Y	N	N	5-228
A24	(Slip compensation response time)	0.01 to 10.00 s	Y	Y1 Y2	0.50	Y	Y	N	N	N	
A25	(Slip compensation gain for braking)	0.0 to 200.0%	Y*	Y	100.0	Y	Y	Y	N	N	
A26	(Rated slip frequency)	0.00 to 15.00Hz	N	Y1 Y2	*6	Y	Y	Y	N	N	
A27	(Iron loss factor 1)	0.00 to 20.00%	Y	Y1 Y2	*6	Y	Y	Y	Y	N	
A30	(Magnetic saturation factor 1) *5	0.0 to 300.0 %	Y	Y1 Y2	*6	N	N	Y	Y	N	
A31	(Magnetic saturation factor 2) *5	0.0 to 300.0 %	Y	Y1 Y2	*6	N	N	Y	Y	N	
A32	(Magnetic saturation factor 3) *5	0.0 to 300.0 %	Y	Y1 Y2	*6	N	N	Y	Y	N	
A33	(Magnetic saturation factor 4) *5	0.0 to 300.0 %	Y	Y1 Y2	*6	N	N	Y	Y	N	
A34	(Magnetic saturation factor 5) *5	0.0 to 300.0 %	Y	Y1 Y2	*6	N	N	Y	Y	N	
A39	Motor 2 selection	0: Motor characteristics 0 (Fuji standard IM, 8-series) 1: Motor characteristics 1 (HP rating IMs) 4: Other IMs	N	Y1 Y2	U:1 ACEJK:0	Y	Y	Y	Y	N	
A40	Slip compensation 2 (Operating conditions selection)	0: Enable during acceleration/deceleration, enable at base frequency or higher 1: Disable during acceleration/deceleration, enable at base frequency or higher 2: Enable during acceleration/deceleration, disable at base frequency or higher 3: Disable during acceleration/deceleration, disable at base frequency or higher	N	Y	0	Y	Y	N	N	N	
A41	Output current fluctuation damping gain for motor 2	0.00 to 1.00	Y	Y	0.20	Y	Y	N	N	N	
A43	Speed control 2 *5 (Speed command filter)	0.000 to 5.000 s	Y	Y	0.020	N	Y	Y	N	Y	
A44	(Speed detection filter)	0.000 to 0.100 s	Y*	Y	0.005	N	Y	Y	N	Y	
A45	P (Gain)	0.1 to 200.0 times	Y*	Y	10.0	N	Y	Y	N	Y	
A46	I (Integral time)	0.001 to 9.999 s; 999 (Cancel integral term)	Y	Y	0.100	N	Y	Y	N	Y	
A47	FF (Gain)	0.00 to 99.99 s	Y	Y	0.00	N	N	Y	N	Y	
A49	(Notch filter resonance frequency)	1 to 200 Hz	Y	Y	200	N	N	Y	N	N	
A50	(Notch filter attenuation level)	0 to 20 dB	Y	Y	0	N	N	Y	N	N	
A51	Cumulative motor run time 2	0 to 9999 Change in cumulative motor run time (Reset is enabled) (in units of 10 hours)	N	N	-	Y	Y	Y	Y	N	-
A52	Startup counter for motor 2	For adjustment at replacement (0000 to FFFF in hexadecimal)	Y	N	-	Y	Y	Y	Y	N	
A53	Motor 2 (%X correction factor 1)	0 to 300%	Y	Y1 Y2	100	Y	Y	Y	Y	N	
A55	(Torque current under vector control) *5	0.00 to 2000 A	N	Y1 Y2	*6	N	N	Y	Y	N	
A56	(Induced voltage factor under vector control) *5	50 to 100 %	N	Y1 Y2	*6	N	N	Y	Y	N	
A98	Motor 2 (Function selection)	0 to 255 (Data is displayed in decimal, Meaning of each bit 0: Disable; 1 Enable) bit0: Current limiter (F43, F44) bit1: Rotational direction control (H08) bit2: Non-linear V/f (H50 to H53, H65, H66) bit3: PID control (J01 to J62, H91) bit4: Brake signal bit5: Braking timer at the Startup (H195) Bit6 to 7: Reserved *9	N	Y	0	Y	Y	Y	Y	Y	5-195

Factory default---A (For Asia), C (for China), E (for Europe), U (For USA), J (for Japan), K (for Korea)

*5: Available at ROM version 0300 or later.

*6: Factory defaults are depended on motor capacity. Refer to "5.2.4 Motor constant".

*9: Factory use. Do not change these function codes.

■ **b codes: Motor control parameter 3**

Code	Name	Data setting range	Change when running	Data copying	Factory Default	Drive control					Related page
						V/f	PG V/f	w/PG	Torque control	PM	
b43	Speed control 3 *5 (Speed command filter)	0.000 to 5.000 s	Y	Y	0.020	N	Y	Y	N	Y	5-228
b44	(Speed detection filter)	0.000 to 0.100 s	Y*	Y	0.005	N	Y	Y	N	Y	
b45	P (Gain)	0.1 to 200.0	Y*	Y	10.0	N	Y	Y	N	Y	
b46	I (Integral time)	0.001 to 9.999 s; 999 (Cancel integral term)	Y*	Y	0.100	N	Y	Y	N	Y	
b47	FF (Gain)	0.00 to 99.99	Y*	Y	0.00	N	N	Y	N	Y	
b49	(Notch filter resonance frequency)	1 to 200Hz	Y	Y	200	N	N	Y	N	N	
b50	(Notch filter attenuation level)	0 to 20dB	Y	Y	0	N	N	Y	N	N	

*5: Available at ROM version 0300 or later.

■ **r codes: Motor control parameter 4**

Code	Name	Data setting range	Change when running	Data copying	Factory Default	Drive control					Related page
						V/f	PG V/f	w/PG	Torque control	PM	
r43	Speed control 4 *5 (Speed command filter)	0.000 to 5.000 s	Y	Y	0.020	N	Y	Y	N	Y	5-228
r44	(Speed detection filter)	0.000 to 0.100 s	Y*	Y	0.005	N	Y	Y	N	Y	
r45	P (Gain)	0.1 to 200.0 times	Y*	Y	10.0	N	Y	Y	N	Y	
r46	I (Integral time)	0.001 to 9.999 s; 999 (Cancel integral term)	Y*	Y	0.100	N	Y	Y	N	Y	
r47	FF (Gain)	0.00 to 99.99	Y*	Y	0.00	N	N	Y	N	Y	
r49	(Notch filter resonance frequency)	1 to 200 Hz	Y	Y	200	N	N	Y	N	N	
r50	(Notch filter attenuation level)	0 to 20 dB	Y	Y	0	N	N	Y	N	N	

*5: Available at ROM version 0300 or later.

■ J codes: Application Functions 1 (Application function 1)

Code	Name	Data setting range	Change when running	Data copying	Factory Default	Drive control					Related page
						V/f	PG V/f	w/ PG	Torque control	PM	
J01	PID control (Mode selection)	0: Disable 1: Process (normal operation) 2: Process (inverse operation) 3: Speed control (Dancer)	N	Y	0	Y	Y	Y	N	Y	5-197
J02	(Remote command)	0: Keypad key operation (⊙/⊘key) 1: PID process command 1 (Analog input: Terminals 12, C1 and V2) 3: UP/DOWN 4: Communication	N	Y	0	Y	Y	Y	N	Y	5-198
J03	P (Gain)	0.000 to 30.000 times	Y	Y	0.100	Y	Y	Y	N	Y	5-204
J04	I (Integral time)	0.0 to 3600.0 s	Y	Y	0.0	Y	Y	Y	N	Y	
J05	D (Differential time)	0.00 to 600.00 s	Y	Y	0.00	Y	Y	Y	N	Y	
J06	(Feedback filter)	0.0 to 900.0 s *1	Y	Y	0.5	Y	Y	Y	N	Y	
J10	(Anti-reset windup)	0 to 200%	Y	Y	200	Y	Y	Y	N	Y	5-207
J11	(Select Warnig output)	0: Warning caused by process command value 1: Warning caused by process command value with hold 2: Warning caused by process command value with latch 3: Warning caused by process command value with hold and latch 4: Warning caused by PID error value 5: Warning caused by PID error value with hold 6: Warning caused by PID error value with latch 7: Warning caused by PID error value with hold and latch	Y	Y	0	Y	Y	Y	N	Y	5-208
J12	(Upper limit of warning (AH))	-100% to 100%	Y	Y	100	Y	Y	Y	N	Y	
J13	(Lower limit of warning (AL))	-100% to 100%	Y	Y	0	Y	Y	Y	N	Y	
J15	(Sleep frequency)	0.0 (Disable): 1.0 to 500.0 Hz	Y	Y	0.0	Y	Y	Y	N	Y	5-210
J16	(Sleep timer)	0 to 60 s	Y	Y	30	Y	Y	Y	N	Y	
J17	(Wakeup frequency)	0.0 to 500.0Hz	Y	Y	0.0	Y	Y	Y	N	Y	
J18	(Upper limit of PID process output)	-150% to 150% ; 999 (Depends on setting of F15)	Y	Y	999	Y	Y	Y	N	Y	5-211
J19	(Lower limit of PID process output)	-150% to 150% ; 999 (Depends on setting of F16)	Y	Y	999	Y	Y	Y	N	Y	
J23	(Wakeup level of PID error)	0.0 to 100.0%	Y	Y	0.0	Y	Y	Y	N	Y	5-210
J24	(Wakeup timer)	0 to 3600 s	Y	Y	0	Y	Y	Y	N	Y	
J57	(Dancer position set point)	-100 to 0 to 100%	Y	Y	0	Y	Y	Y	N	Y	5-211
J58	(Detection width of dancer position error)	0: Disable switching PID constant 1 to 100%: Manually set value	Y	Y	0	Y	Y	Y	N	Y	5-212
J59	P (Gain) 2	0.000 to 30.000 times	Y	Y	0.100	Y	Y	Y	N	Y	
J60	I (Integral time) 2	0.0 to 3600.0 s	Y	Y	0.0	Y	Y	Y	N	Y	
J61	D (Differential time) 2	0.00 to 600.00 s	Y	Y	0.00	Y	Y	Y	N	Y	
J62	(PID control block selection)	0 to 3 bit0: Select polarity compensation for PID output/error 0=Plus (Addition); 1=Minus (Subtraction) bit1: Select compensation factor for PID output 0=Ratio (relative to the main setting) 1=Speed command (relative to maximum frequency)	N	Y	0	Y	Y	Y	N	Y	5-212
J63	Overload stop (Item selection)	0: Torque, 1: Current	Y	Y	0	Y	Y	Y	N	Y	5-213
J64	(Detection level)	20 to 200%	Y	Y	100	Y	Y	Y	N	Y	
J65	(Mode selection)	0: Disable 1: Decelerate to stop 2: Coast to a stop	N	Y	0	Y	Y	Y	N	Y	
J66	(Operation mode)	0: During constant speed running and deceleration 1: During constant speed running 2: Anytime	Y	Y	0	Y	Y	Y	N	Y	
J67	(Timer)	0.00 to 600.00 s	Y	Y	0.00	Y	Y	Y	N	Y	

5.2 Function Codes Table

Code	Name	Data setting range	Change when running	Data copying	Factory Default	Drive control					Related page
						V/f	PG V/f	w/PG	Torque control	PM	
J68	Brake control signal (Brake-release current)	0.00 to 300.00%	Y	Y	100.0	Y	Y	Y	N	N	5-214
J69	(Brake-release frequency/speed)	0.0 to 25.0 Hz	Y	Y	1.0	Y	Y	N	N	N	
J70	(Brake-release timer)	0.00 to 5.00 s	Y	Y	1.00	Y	Y	Y	N	N	
J71	(Brake-applied frequency/speed)	0.0 to 25.0 Hz	Y	Y	1.0	Y	Y	Y	N	N	
J72	(Brake-applied timer)	0.00 to 5.00 s	Y	Y	1.00	Y	Y	Y	N	N	
J73	Positioning control *5 (Start timer)	0.0 to 1000.0 s	Y	Y	0.0	Y	Y	N	N	N	5-217
J74	(Start point; upper digits)	-999(83E7) to 999(03E7) -999(83E7) to -1(8001) 0(0000) to 999(03E7)	Y	Y	0	Y	Y	N	N	N	
J75	(Start point; lower digits)	0(0000) to 9999(270F) ; P = -1(FFFF)	Y	Y	0	Y	Y	N	N	N	
J76	(Preset point; upper digits)	-999(83E7) to 999(03E7) -999(83E7) to -1(8001) 0(0000) to 999(03E7)	Y	Y	0	Y	Y	N	N	N	
J77	(Preset point; lower digits)	0(0000) to 9999(270F) ; P = -1(FFFF)	Y	Y	0	Y	Y	N	N	N	
J78	(Creep speed SW point; upper digits)	0 to 999	Y	Y	0	Y	Y	N	N	N	
J79	(Creep speed SW point; lower digits)	0 to 9999	Y	Y	0	Y	Y	N	N	N	
J80	(Creep speed)	0 to 500 Hz	Y	Y	0.0	Y	Y	N	N	N	
J81	(End point; upper digits)	-999(83E7) to 999(03E7) -999(83E7) to -1(8001) 0(0000) to 999(03E7)	Y	Y	0	Y	Y	N	N	N	
J82	(End point; lower digits)	0(0000) to 9999(270F)	Y	Y	0	Y	Y	N	N	N	
J83	(Completion range)	0 to 9999	Y	Y	0	Y	Y	N	N	N	
J84	(End timer)	0.0 to 1000.0 s	Y	Y	0.0	Y	Y	N	N	N	
J85	(Coasting compensation)	0 to 9999	Y	Y	0	Y	Y	N	N	N	
J86	(End point: serial pulse input format)	0: Direction and pulse 1: Forward and reverse pulse	Y	Y	0	Y	Y	N	N	N	
J87	(Preset positioning requirement)	0: Allow to preset at the forward rotation only 1: Allow to preset at the reverse rotation only 2: Allow to preset at any rotations	N	Y	0	Y	Y	N	N	N	
J88	(Direction of detected position)	0: Not switch the direction of detected position 1: Switch the direction of detected position	N	Y	0	Y	Y	N	N	N	
J95	Brake control signal *5 (Brake-release torque)	0.00 to 300.00 %	Y	Y	100.00	N	N	Y	N	N	5-214
J96	(Brake-apply conditions)	0 to 31 Bit0: Speed detection / Speed command (0: Speed detection ; 1: Speed command) Bit1: Reserved Bit2: Reserved Bit3: Reserved Bit4: Brake-apply condition (0: Regardless of run command status (ON or OFF) ; 1: Only when run command is OFF.)	Y	Y	0	N	N	Y	N	N	
J97	Servo lock *5 (Gain)	0.000 to 9.999 times	Y*	Y	0.010	N	N	Y	N	N	5-226
J98	(Completion timer)	0.000 to 1.000 s	Y	Y	0.100	N	N	Y	N	N	
J99	(Completion range)	0 to 9999	Y	Y	10	N	N	Y	N	N	

*5: Available at ROM version 0300 or later.

5.2 Function Codes Table

Code	Name	Data setting range	Change when running	Data copying	Factory Default	Drive control					Related page
						V/f	PG V/f	w/PG	Torque control	PM	
J105	PID control (Display unit)	0 to 80 0: Inherit (PID Control 1 feedback unit) 1: none 2: % 4: r/min 7: kW [Flow] 20: m ³ /s 21: m ³ /min 22: m ³ /h 23: L/s 24: L/min 25: L/h [Pressure] 40: Pa 41: kPa 42: MPa 43: mbar 44: bar 45: mmHg 46: psi PSI (Pounds per square inch absolute) 47: mWG 48: inWG [Temperature] 60: K 61: degreeC 62: degreeF [Concentration] 80: ppm	N	Y	0	Y	Y	Y	N	Y	5-227
J106	(Maximum scale)	-999.00 to 0.00 to 9990.00	N	Y	100	Y	Y	Y	N	Y	
J107	(Minimum scale)	-999.00 to 0.00 to 9990.00	N	Y	0.00	Y	Y	Y	N	Y	
J136	PID multistep command (Multistep command 1)	-999.00 to 0.00 to 9990.00	Y	Y	0.00	Y	Y	Y	N	Y	5-227
J137	(Multistep command 2)	-999.00 to 0.00 to 9990.00	Y	Y	0.00	Y	Y	Y	N	Y	
J138	(Multistep command 3)	-999.00 to 0.00 to 9990.00	Y	Y	0.00	Y	Y	Y	N	Y	

■ d codes: Application Functions 2 (Application function 2)

Code	Name	Data setting range	Change when running	Data copying	Factory Default	Drive control					Related page
						V/f	PG V/f	w/ PG	Torque control	PM	
d01	Speed control 1 *5 (Speed command filter)	0.000 to 5.000 s	Y	Y	0.020	N	Y	Y	N	Y	5-228
d02	(Speed detection filter)	0.000 to 0.100 s	Y*	Y	0.005	N	Y	Y	N	Y	
d03	P (Gain)	0.1 to 200.0 times	Y*	Y	10.0	N	Y	Y	N	Y	
d04	I (Integral time)	0.001 to 9.999 s; 999(Cancel integral term)	Y	Y	0.100	N	Y	Y	N	Y	
d05	FF (Gain)	0.00 to 99.99 s	Y	Y	0.00	N	N	Y	N	Y	
d07	(Notch filter resonance frequency)	1 to 200 Hz	Y	Y	200	N	N	Y	N	N	
d08	(Notch filter attenuation level)	0 to 20dB	Y	Y	0	N	N	Y	N	N	
d09	Speed control (Jogging) *5 (Speed command filter)	0.000 to 5.000 s	Y	Y	0.020	N	Y	Y	N	N	
d10	(Speed detection filter)	0.000 to 0.100 s	Y*	Y	0.005	N	Y	Y	N	N	
d11	P (Gain)	0.1 to 200.0 times	Y*	Y	10.0	N	Y	Y	N	N	
d12	I (Integral time)	0.001 to 9.999 s; 999(Cancel integral term)	Y*	Y	0.100	N	Y	Y	N	N	
d14	Feedback Input *5 (Pulse input format)	0: Frequency and direction 1: Forward and reverse pulse 2: Quadrature A/B signal(B phase lead) 3: Quadrature A/B signal(A phase lead)	N	Y	2	N	Y	Y	Y	N	5-231
d15	(Encoder pulse resolution)	0014 to EA60(Hexadecimal) pulses (20 to 60000 (Decimal) pulses)	N	Y	0400 (1024)	N	Y	Y	Y	N	
d16	(Pulse scaling factor 1)	1 to 9999	N	Y	1	N	Y	Y	Y	N	
d17	(Pulse scaling factor 2)	1 to 9999	N	Y	1	N	Y	Y	Y	N	
d21	Speed agreement / PG error *5 (Hysteresis width)	0.0 to 50.0 %	Y	Y	10.0	N	Y	Y	N	Y	5-233
d22	(Detection timer)	0.00 to 10.00 s	Y	Y	0.50	N	Y	Y	N	Y	
d23	PG error processing *5	0: Continue to run 1 1: Stop with alarm 1 2: Stop with alarm 2 3: Continue to run 2 4: Stop with alarm 3 5: Stop with alarm 4	N	Y	2	N	Y	Y	N	Y	
d24	Zero speed control *5	0: Disable at startup 1: Enable at startup	N	Y	0	N	N	Y	N	N	5-234
d25	ASR switching time *5	0.000 to 1.000 s	Y	Y	0.000	N	Y	Y	Y	Y	5-234
d32	Speed limit / Over speed level 1 *5	0 to 110 %	Y	Y	100	N	N	Y	Y	Y	5-234
d33	Speed limit / Over speed level 2 *5	0 to 110 %	Y	Y	100	N	N	Y	Y	Y	
d35	Over speed detection level *5	0 to 120 %; 999 999: Depend on d32, d33	Y	Y	999	N	Y	Y	Y	Y	5-234
d41	Application specific function selection *5	0: Invalid 1: Line speed control with speed sensor 2: Master-follower operation (Immediate synchronization mode at the start, without Z phase) 3: Master-follower operation (Start after synchronization mode) 4: Master-follower operation (Immediate synchronization mode at the start, with Z phase)	N	Y	0	N	Y	N	N	N	5-234
d51	Reserved *9	-500 to 500	N	Y	*12	Y	Y	Y	Y	Y	5-237
d52	Reserved *9	-500 to 500	N	Y	*12	Y	Y	Y	Y	Y	
d55	Reserved *9	0000 to 00FF (Display in hexadecimal)	N	Y	0	Y	Y	Y	Y	Y	
d59	Command (Pulse train input) *5 (Pulse input format)	0: Frequency and direction 1: Forward and reverse pulse 2: Quadrature A/B signal(B phase lead) 3: Quadrature A/B signal(A phase lead)	N	Y	0	Y	Y	Y	Y	Y	5-244
d60	(Encoder pulse resolution)	0014 to 0E10 (Hexadecimal) pulses (20 to 3600 (Decimal) pulses)	N	Y	0400 (1024)	N	Y	Y	N	N	5-237
d61	(Filter time constant)	0.000 to 5.000 s	Y	Y	0.005	Y	Y	Y	Y	Y	5-237
d62	(Pulse scaling factor 1)	1 to 9999	Y	Y	1	Y	Y	Y	Y	Y	
d63	(Pulse scaling factor 2)	1 to 9999	Y	Y	1	Y	Y	Y	Y	Y	

*5: Available at ROM version 0300 or later.
 *9: Factory use. Do not change these function codes.
 *12:FRN0012E2■-7□ or below: 20, FRN0115E2■-2□ or below: 20, FRN0290E2■-4□ or below: 20, FRN0361E2■-4□ and FRN0415E2■-4□;50, FRN0520E2■-4□ or above: 100.

5.2 Function Codes Table

Code	Name	Data setting range	Change when running	Data copying	Factory Default	Drive control					Related page
						V/f	PG V/f	w/ PG	Torque control	PM	
d67	PMSM starting mode *5 (Auto search)	0: Disable 1: Enable (At restart after momentary power failure) 2: Enable (At restart after momentary power failure and at normal start)	N	Y	2	N	N	N	N	Y	5-159 5-237
d69	Reserved *9	30.0 to 100.0Hz	Y	Y	30.0	Y	Y	N	N	N	5-237
d70	Speed control limiter *5	0.00 to 100.00 %	Y	Y	100.00	N	Y	N	N	N	5-247
d71	Master follower control *5 (Main speed regulator gain)	0.00 to 1.50 times	Y	Y	1.00	N	Y	Y	N	N	5-238
d72	(APR gain)	0.00 to 200.00 times	Y	Y	15.00	N	Y	Y	N	N	
d73	(APR positive output limiter)	20 to 200 %; 999: Invalid	Y	Y	999	N	Y	Y	N	N	
d74	(APR negative output limiter)	20 to 200 %; 999: Invalid	Y	Y	999	N	Y	Y	N	N	
d75	(Z phase alignment gain)	0.00 to 10.00 times	Y	Y	1.00	N	Y	Y	N	N	
d76	(Offset angle between master and follower)	0 to 359 deg	Y	Y	0	N	Y	Y	N	N	
d77	(Synchronous completion detection angle)	0 to 359 deg	Y	Y	15	N	Y	Y	N	N	
d78	(Excessive error detection level)	0 to 65535 (10 unit pulse)	Y	Y	65535	N	Y	Y	N	N	
d79	Reserved *5 *9	0; 80 to 240 V (200V order) 160 to 500 V (400V order); 999	N	Y2	0	N	N	N	N	Y	5-237
d88	Reserved *5 *9	0.00 to 100.00 %, 999	Y	Y	999	N	N	N	N	Y	5-247
d90	Magnetic flux level during deceleration under vector control *5	100 to 300 %	Y	Y	150	N	N	Y	N	N	
d91	Reserved *9	0.00 to 2.00, 999	Y	Y	999	-	-	-	-	-	5-237
d92	Reserved *5 *9	0.00 to 10.00	Y	Y	0.30	-	-	-	-	-	
d93	Reserved *5 *9	0.00 to 10.00; 999	Y	Y	999	N	N	N	N	Y	
d94	Reserved *5 *9	0.00 to 10.00; 999	Y	Y	999	N	N	N	N	Y	
d95	Reserved *5 *9	0.00 to 10.00; 999	Y	Y	999	N	N	N	N	Y	
d96	Reserved *5 *9	-50.0 to 50.0; 999	Y	Y	999	N	N	N	N	Y	
d97	Reserved *5 *9	-50.0 to 50.0; 999	Y	Y	999	N	N	N	N	Y	
d99	Extension function 1	0 to 127	Y	Y	0						
	Bit 0-2: Reserved *9					-	-	-	-	-	
	Bit 3: JOG operation from communication (0: Disable; 1: Enable)					Y	Y	Y	N	Y	
	Bit 4-8: Reserved *9					-	-	-	-	-	

*5: Available at ROM version 0300 or later.

*9: Factory use. Do not change these function codes.

■ U codes: Application Functions 3 (Customizable logic)

Code	Name	Data setting range	Change when running	Data copying	Factory Default	Drive control					Related page
						V/f	PG V/f	w/ PG	Torque control	PM	
U00	Customizable logic (Mode selection)	0: Disable 1: Enable (Customizable logic operation) ECL alarm occurs when the value is changed from 1 to 0 during operation.	Y	Y	0	Y	Y	Y	Y	Y	5-250
U01	Customizable logic: Step 1 (Block selection)	[Digital] 0: No function assigned 10 to 15: Through output + General-purpose timer 20 to 25: Logical AND + General-purpose timer 30 to 35: Logical OR + General-purpose timer 40 to 45: Logical XOR + General-purpose timer 50 to 55: Set priority flip-flop + General-purpose timer 60 to 65: Reset priority flip-flop + General-purpose timer 70, 72, 73: Rising edge detector + General-purpose timer 80, 82, 83: Falling edge detector + General-purpose timer 90, 92, 93: Rising & falling edges detector + General-purpose timer 100 to 105: Hold + General-purpose timer 110: Increment counter 120: Decrement counter 130: Timer with reset input General-purpose timer function (Least significant digit 0 to 5) _0: No timer _1: On-delay timer _2: Off-delay timer _3: Pulse (1 shot) _4: Retriggerable timer _5: Pulse train output [Analog] 2001: Adder 2002: Subtractor 2003: Multiplier 2004: Divider 2005: Limiter 2006: Absolute value of input 2007: Inverting adder 2008: Variable limiter 2009: Linear function 2051 to 2056: Comparator1 to 6 2071, 2072: Window comparator1, 2 2101: High selector 2102: Low selector 2103: Average of inputs 2151: Loading function from S13 2201: Clip and map function 2202: Scale converter 3001: Quadratic function 3002: Square root function [Digital, Analog] 4001: Hold 4002: Inverting adder with enable 4003, 4004: Selector 1, 2 4005: LPF(Low-pass filter) with enable 4006: Rate limiter with enable 5000: Selector 3 5100: Selector 4 6001: Reading function code 6002: Writing function code 6003: Temporary change of function code 6101: PID dancer output gain frequency	N	Y	0	Y	Y	Y	Y	Y	

5.2 Function Codes Table

Code	Name	Data setting range	Change when running	Data copying	Factory Default	Drive control					Related page
						V/f	PG V/f	w/PG	Torque control	PM	
U02	Customizable logic: Step 1 (Input 1)	[Digital] 0 to 105: The same as E20 value. However, 27, 111 to 120 cannot be selected	N	Y	100	Y	Y	Y	Y	Y	
U03	(Input 2)	2001 to 2200 (3001 to 3200): Output of Step 1 to 200 4001 (5001): X1 terminal input signal "X1" 4002 (5002): X2 terminal input signal "X2" 4003 (5003): X3 terminal input signal "X3" 4004 (5004): X4 terminal input signal "X4" 4005 (5005): X5 terminal input signal "X5" 4010 (5010): FWD terminal input signal "FWD" 4011 (5011): REV terminal input signal "REV" *4021(5021): Digital input I1 (OPC-DIO) *5 *4022(5022): Digital input I2 (OPC-DIO) *5 *4023(5023): Digital input I3 (OPC-DIO) *5 *4024(5024): Digital input I4 (OPC-DIO) *5 *4025(5025): Digital input I5 (OPC-DIO) *5 *4026(5026): Digital input I6 (OPC-DIO) *5 *4027(5027): Digital input I7 (OPC-DIO) *5 *4028(5028): Digital input I8 (OPC-DIO) *5 *4029(5029): Digital input I9 (OPC-DIO) *5 *4030(5030): Digital input I10 (OPC-DIO) *5 *4031(5031): Digital input I11 (OPC-DIO) *5 *4032(5032): Digital input I12 (OPC-DIO) *5 *4033(5033): Digital input I13 (OPC-DIO) *5 6000 (7000): Final run command RUN "FL_RUN" 6001 (7001): Final run command FWD "FL_FWD" 6002 (7002): Final run command REV "FL_REV" 6003 (7003): Accelerating "DACC" 6004 (7004): Decelerating "DDEC" 6005 (7005): Under anti-regenerative control "REGA" 6006 (7006): Within dancer reference position "DR_REF" 6007 (7007): With/without alarm factor "ALM_ACT" * Inside the () is the negative logic signal. (OFF at short-circuit) [Analog] 8000 to 8021: The value with 8000 added to F31 9001: Analog 12 terminal input signal [12] 9002: Analog C1 terminal input signal [C1] (C1) 9003: Analog V2 terminal input signal [C1] (V2) *9004: Analog 32 terminal input signal [32] *5 *9005: Analog C2 terminal input signal [C2] *5	N	Y	100	Y	Y	Y	Y	Y	
U04	(Function 1)	-9990 to 0.00 to 9990	N	Y	0.00	Y	Y	Y	Y	Y	
U05	(Function 2)		N	Y	0.00	Y	Y	Y	Y	Y	

*: The use of the option card lets those functions remain in effect.
 *5: Available at ROM version 0300 or later.

Customizable logic Step 1 to 14 function code is assigned as follows: Setting value is the same as U01 to U05.

Block selection	Step1	Step2	Step3	Step4	Step5	Step6	Step7	Step8	Step9	Step10
Input 1	U01	U06	U11	U16	U21	U26	U31	U36	U41	U46
Input 2	U02	U07	U12	U17	U22	U27	U32	U37	U42	U47
Function 1	U03	U08	U13	U18	U23	U28	U33	U38	U43	U48
Function 2	U04	U09	U14	U19	U24	U29	U34	U39	U44	U49
	U05	U10	U15	U20	U25	U30	U35	U40	U45	U50
Block selection	Step11	Step12	Step13	Step14						
Input 1	U51	U56	U61	U66						
Input 2	U52	U57	U62	U67						
Function 1	U53	U58	U63	U68						
Function 2	U54	U59	U64	U69						
	U55	U60	U65	U70						

5.2 Function Codes Table

Code	Name	Data setting range	Change when running	Data copying	Factory Default	Drive control					Related page
						V/f	PG V/f	w/PG	Torque control	PM	
U71	Customizable logic (Output selection) Output signal 1	0: Disable 1 to 200: Output of Step 1 to 200 "S001" to "S0200"	N	Y	0	Y	Y	Y	Y	Y	
U72	Output signal 2		N	Y	0	Y	Y	Y	Y	Y	
U73	Output signal 3		N	Y	0	Y	Y	Y	Y	Y	
U74	Output signal 4		N	Y	0	Y	Y	Y	Y	Y	
U75	Output signal 5		N	Y	0	Y	Y	Y	Y	Y	
U76	Output signal 6		N	Y	0	Y	Y	Y	Y	Y	
U77	Output signal 7		N	Y	0	Y	Y	Y	Y	Y	
U78	Output signal 8		N	Y	0	Y	Y	Y	Y	Y	
U79	Output signal 9		N	Y	0	Y	Y	Y	Y	Y	
U80	Output signal 10		N	Y	0	Y	Y	Y	Y	Y	
U81	Customizable logic (Function selection) Output signal 1	0 to 172 (1000 to 1172): Same as E01 8001 to 8020: The value with 8000 added to E61	N	Y	100	Y	Y	Y	Y	Y	
U82	Output signal 2		N	Y	100	Y	Y	Y	Y	Y	
U83	Output signal 3		N	Y	100	Y	Y	Y	Y	Y	
U84	Output signal 4		N	Y	100	Y	Y	Y	Y	Y	
U85	Output signal 5		N	Y	100	Y	Y	Y	Y	Y	
U86	Output signal 6		N	Y	100	Y	Y	Y	Y	Y	
U87	Output signal 7		N	Y	100	Y	Y	Y	Y	Y	
U88	Output signal 8		N	Y	100	Y	Y	Y	Y	Y	
U89	Output signal 9		N	Y	100	Y	Y	Y	Y	Y	
U90	Output signal 10		N	Y	100	Y	Y	Y	Y	Y	
U91	Customizable logic timer monitor (Step selection)	0: Monitor disable 1 to 200: Step 1 to 200	Y	N	0	Y	Y	Y	Y	Y	
U92	Customizable logic (The coefficients of the approximate formula) (Mantissa of KA1)	-9.999 to 9.999	N	Y	0.000	Y	Y	Y	Y	Y	
U93	(Exponent part of KA1)	-5 to 5	N	Y	0	Y	Y	Y	Y	Y	
U94	(Mantissa of KB1)	-9.999 to 9.999	N	Y	0.000	Y	Y	Y	Y	Y	
U95	(Exponent part of KB1)	-5 to 5	N	Y	0	Y	Y	Y	Y	Y	
U96	(Mantissa of KC1)	-9.999 to 9.999	N	Y	0.000	Y	Y	Y	Y	Y	
U97	(Exponent part KC1)	-5 to 5	N	Y	0	Y	Y	Y	Y	Y	
U100	Task process cycle setting	0: Auto select from 2, 5, 10 or 20 ms depending on the number of steps 2: 2 ms (Up to 10 step) 5: 5 ms (Up to 50 step) 10: 10 ms (Up to 100 step) 20: 20ms (Up to 200 step) *5	N	Y	0	Y	Y	Y	Y	Y	
U101	Customizable logic (Operating point 1 (X1))	-999.00 to 0.00 to 9990.00	Y	Y	0.00	Y	Y	Y	Y	Y	5-250 5-273
U102	(Operating point 1 (Y1))		Y	N		Y	Y	Y	Y	Y	
U103	(Operating point 2 (X2))		Y	N		Y	Y	Y	Y	Y	
U104	(Operating point 2 (Y2))		Y	N		Y	Y	Y	Y	Y	
U105	(Operating point 3 (X3))		Y	N		Y	Y	Y	Y	Y	
U106	(Operating point 3 (Y3))		Y	N		Y	Y	Y	Y	Y	
U107	Customizable logic (Auto calculation of the coefficients of the approximate formula)	0: Invalid 1: Execute calculation (When the calculation is finished, the results are stored to the function code U92 to U97)	N	N	0	Y	Y	Y	Y	Y	5-250 5-274

5.2 Function Codes Table

Code	Name	Data setting range	Change when running	Data copying	Factory Default	Drive control					Related page
						V/f	PG V/f	w/PG	Torque control	PM	
U121	Customizable logic (User parameter 1)	-9990.00 to 0.00 to 9990.00	Y	Y	0.00	Y	Y	Y	Y	Y	5-250
U122	(User parameter 2)					Y	Y	Y	Y	Y	
U123	(User parameter 3)					Y	Y	Y	Y	Y	
U124	(User parameter 4)					Y	Y	Y	Y	Y	
U125	(User parameter 5)					Y	Y	Y	Y	Y	
U126	(User parameter 6)					Y	Y	Y	Y	Y	
U127	(User parameter 7)					Y	Y	Y	Y	Y	
U128	(User parameter 8)					Y	Y	Y	Y	Y	
U129	(User parameter 9)					Y	Y	Y	Y	Y	
U130	(User parameter 10)					Y	Y	Y	Y	Y	
U131	(User parameter 11)					Y	Y	Y	Y	Y	
U132	(User parameter 12)					Y	Y	Y	Y	Y	
U133	(User parameter 13)					Y	Y	Y	Y	Y	
U134	(User parameter 14)					Y	Y	Y	Y	Y	
U135	(User parameter 15)					Y	Y	Y	Y	Y	
U136	(User parameter 16)					Y	Y	Y	Y	Y	
U137	(User parameter 17)					Y	Y	Y	Y	Y	
U138	(User parameter 18)					Y	Y	Y	Y	Y	
U139	(User parameter 19)					Y	Y	Y	Y	Y	
U140	(User parameter 20)					Y	Y	Y	Y	Y	
U171	Customizable logic (Storage area 1)	-9990.00 to 0.00 to 9990.00	Y	Y	0.00	Y	Y	Y	Y	Y	
U172	(Storage area 2)					Y	Y	Y	Y	Y	
U173	(Storage area 3)					Y	Y	Y	Y	Y	
U174	(Storage area 4)*5					Y	Y	Y	Y	Y	
U175	(Storage area 5)*5					Y	Y	Y	Y	Y	
U190	Customizable logic setting step (Step number)	1 to 200	Y	Y	15	Y	Y	Y	Y	Y	
U191	Setting step (Select block)	Same as U01	N	Y	0	Y	Y	Y	Y	Y	
U192	(Input 1)	Same as U02	N	Y	100	Y	Y	Y	Y	Y	
U193	(Input 2)	Same as U03	N	Y	100	Y	Y	Y	Y	Y	
U194	(Function 1)	Same as U04	N	Y	0.00	Y	Y	Y	Y	Y	
U195	(Function 2)	Same as U05	N	Y	0.00	Y	Y	Y	Y	Y	
U196	Customizable logic ROM version Upper digit (Monitor)	0 to 9999	N	N	0	Y	Y	Y	Y	Y	
U197	Customizable logic ROM version Upper digit (For User setting)	0 to 9999	N	Y	0	Y	Y	Y	Y	Y	
U198	Customizable logic ROM version Lower digit (Monitor)	0 to 9999	N	N	0	Y	Y	Y	Y	Y	
U199	Customizable logic ROM version Lower digit (For User setting)	0 to 9999	N	Y	0	Y	Y	Y	Y	Y	

*5: Available at ROM version 0300 or later.

■ y codes: LINK Functions (Link function)

Code	Name	Data setting range	Change when running	Data copying	Factory Default	Drive control					Related page
						V/f	PG V/f	w/PG	Torque control	PM	
y01	RS-485 Communication 1 (Station address)	1 to 255	N	Y	1	Y	Y	Y	Y	Y	5-277
y02	(Communications error processing)	0: Immediately trip with alarm E_r-B 1: Trip with alarm E_r-B after running for the period specified by timer y03 2: Retry during the period specified by timer y03. If the retry fails, trip with alarm E_r-B . If it succeeds, continue to run. 3: Continue to run	Y	Y	0	Y	Y	Y	Y	Y	
y03	(Timer)	0.0 to 60.0 s	Y	Y	2.0	Y	Y	Y	Y	Y	
y04	(Baud rate)	0: 2400 bps 1: 4800 bps 2: 9600 bps 3: 19200 bps 4: 38400 bps	Y	Y	3	Y	Y	Y	Y	Y	
y05	(Data length selection)	0: 8 bit 1: 7 bits	Y	Y	0	Y	Y	Y	Y	Y	
y06	(Parity selection)	0: None (Stop bit: 2 bits) 1: Even number parity (Stop bit: 1 bits) 2: Odd number parity (Stop bit: 1 bits) 3: None (Stop bit: 1 bits)	Y	Y	0	Y	Y	Y	Y	Y	
y07	(Stop bit selection)	0: 2 bits 1: 1 bits	Y	Y	0	Y	Y	Y	Y	Y	
y08	(Communication time-out detection timer)	0: Not check of the time-out 1 to 60 s	Y	Y	0	Y	Y	Y	Y	Y	
y09	(Response interval time)	0.00 to 1.00 s	Y	Y	0.01	Y	Y	Y	Y	Y	
y10	(Protocol selection)	0: Modbus RTU protocol 1: FRENIC Loader protocol (SX protocol) 2: Fuji general-purpose inverter protocol	Y	Y	1	Y	Y	Y	Y	Y	
y11	RS-485 Communication 2 (Station address)	1 to 255	N	Y	1	Y	Y	Y	Y	Y	
y12	(Communications error processing)	0: Immediately trip with alarm E_r-P 1: Trip with alarm E_r-P after running for the period specified by timer y13 2: Retry during the period specified by timer y13. If the retry fails, trip with alarm E_r-P . If it succeeds, continue to run. 3: Continue to run	Y	Y	0	Y	Y	Y	Y	Y	
y13	(Timer)	0.0 to 60.0 s	Y	Y	2.0	Y	Y	Y	Y	Y	
y14	(Baud rate)	0: 2400 bps 1: 4800 bps 2: 9600 bps 3: 19200 bps 4: 38400 bps	Y	Y	3	Y	Y	Y	Y	Y	
y15	(Data length selection)	0: 8 bits 1: 7 bits	Y	Y	0	Y	Y	Y	Y	Y	
y16	(Parity selection)	0: None (Stop bit: 2 bits) 1: Even number parity (Stop bit: 1 bits) 2: Odd number parity (Stop bit: 1 bits) 3: None (Stop bit: 1 bits)	Y	Y	0	Y	Y	Y	Y	Y	
y17	(Stop bit selection)	0: 2 bits 1: 1 bit	Y	Y	0	Y	Y	Y	Y	Y	
y18	(Communication time-out detection timer)	0: Not check of the time-out 1 to 60 s	Y	Y	0	Y	Y	Y	Y	Y	
y19	(Response interval time)	0.00 to 1.00 s	Y	Y	0.01	Y	Y	Y	Y	Y	
y20	(Protocol selection)	0: Modbus RTU protocol 1: FRENIC Loader protocol (SX protocol) 2: Fuji general-purpose inverter protocol	Y	Y	0	Y	Y	Y	Y	Y	

5.2 Function Codes Table

Code	Name	Data setting range	Change when running	Data copying	Factory Default	Drive control					Related page
						V/f	PG V/f	w/PG	Torque control	PM	
y21	Built-in CAN communication (Node ID)	1 to 127	N	Y	1	Y	Y	Y	Y	Y	5-280
y24	(Baud rate)	0: 125kbps 1: 20kbit/s 2: 50kbit/s 3: 125kbit/s 4: 250kbit/s 5: 500kbit/s 6: 800kbit/s 7: 1Mbit/s	N	Y	0	Y	Y	Y	Y	Y	
y25	Map the inverter function code1 to RPDO No. 3	0000 to FFFF (in hexadecimal)	N	Y	0000	Y	Y	Y	Y	Y	
y26	Map the inverter function code2 to RPDO No. 3	Data mapped I/O (Write)				Y	Y	Y	Y	Y	
y27	Map the inverter function code3 to RPDO No. 3		Y	Y	Y	Y	Y				
y28	Map the inverter function code4 to RPDO No. 3		Y	Y	Y	Y	Y				
y29	Map the inverter function code1 to TPDO No. 3		Y	Y	Y	Y	Y				
y30	Map the inverter function code2 to TPDO No. 3		Y	Y	Y	Y	Y				
y31	Map the inverter function code3 to TPDO No. 3		Y	Y	Y	Y	Y				
y32	Map the inverter function code4 to TPDO No. 3		Y	Y	Y	Y	Y				
y33	(Operation selection)		0: Disable, 1: Enable	Y	Y	0	Y	Y	Y	Y	
y34	(Communications error processing)	This function code is valid in case of y36=-4 or -5. 1: After the time specified by [y35], coast to a stop and trip with [ert]. 2: If the inverter receives any data within the time specified by [y35], ignore the communications error. After the timeout, coast to a stop and trip with [ert]. 10: Immediately decelerate to a stop. Issue [ert] after stopping. 11: After the time specified by [y35], decelerate to a stop. Issue [ert] after stopping. 12: If the inverter receives any data within the time specified by [y35], ignore the communications error. After the timeout, decelerate to a stop and trip with [ert]. Otherwise: Immediately coast to a stop and trip with [ert].	Y	Y	0	Y	Y	Y	Y	Y	
y35	(Communication time-out detection timer)	0.0 to 60.0	Y	Y	0.0	Y	Y	Y	Y	Y	
y36	(Operation selection in abort status) *5	-5 to 3	Y	Y	1	Y	Y	Y	Y	Y	
y95	Data clear processing for communications error	0: Do not clear the data of function codes Sxx when a communications error occurs. (compatible with the conventional inverters) 1: Clear the data of function codes S01/S05/S19 when a communications error occurs. 2: Clear the run command assigned bit of function code S06 when a communications error occurs. 3: Clear both data of S01/S05/S19 and run command assigned bit of S06 when a communications error occurs. * Related alarms: <i>E-r-B, E-r-P, E-r-4, E-r-5, E-r-t</i>	Y	Y	0	Y	Y	Y	Y	Y	5-280
y97	Communication data storage selection	0: Store into nonvolatile memory (Rewritable times are limited) 1: Write into temporary memory (Rewritable times are unlimited) 2: Save all data from temporary memory to nonvolatile memory (After all save, return to Data 1)	Y	Y	0	Y	Y	Y	Y	Y	5-280
y98	Bus link function (Mode selection)	Frequency command Run command 0: Follow H30 Follow H30 1: Bus link Follow H30 2: Follow H30 Bus link 3: Bus link Bus link	Y	Y	0	Y	Y	Y	Y	Y	5-280
y99	Loader link function (Mode selection)	Frequency command Run command 0: Follow H30, y98 Follow H30, y98 1: FRENIC loader Follow H30, y98 2: Follow H30, y98 FRENIC loader 3: FRENIC loader FRENIC loader	Y	N	0	Y	Y	Y	Y	Y	5-281

*5: Available at ROM version 0300 or later.

■ K codes: Keypad functions for TP-A1-E2C

Code	Name	Data setting range	Change when running	Data copying	Factory Default	Drive control				Related page	
						V/f	PG V/f	w/ PG	Torque control		PM
K01	Multifunction keypad TP-A1-E2C (Language selection)	0: Japanese 1: English 2: German 3: French 4: Spanish 5: Italian 6: Chinese 8: Russian 9: Greek 10: Turkish 11: Polish 12: Czech 13: Swedish 14: Portuguese 15: Dutch 16: Malay 17: Vietnamese 18: Thai 19: Indonesian 100: User-Customizable language	Y	Y	J: 0 C: 6 AEUK: 1	Y	Y	Y	Y	Y	-
K02	(Backlight OFF time)	0: Always OFF 1 to 30 min	Y	Y	5	Y	Y	Y	Y	Y	-
K03	(Backlight brightness adjustment)	0 (dark) - 10 (bright)	Y	Y	5	Y	Y	Y	Y	Y	-
K04	(Contrast adjustment)	0 (low) - 10 (high)	Y	Y	5	Y	Y	Y	Y	Y	-
K08	(LCD monitor status display)	0: Not displayed 1: Fully displayed	Y	Y	1	Y	Y	Y	Y	Y	-
K15	(Sub-monitor display selection)	0: Operation guide display 1: Bar graph display	Y	Y	0	Y	Y	Y	Y	Y	-
K16	(Sub-monitor 1 display selection)	1 to 35	Y	Y	13	Y	Y	Y	Y	Y	-
K17	(Sub-monitor 2 display selection)	2: Output frequency 1 (before slip compensation) 3: Reference frequency 4: Motor rotation speed 5: Load rotation speed 6: Line speed 7: Transport time for specified length 8: Speed (%) 13: Output current 14: Output voltage 18: Calculated torque 19: Input power 25: Load factor 26: Motor output 27: Analog input monitor 31: Current position pulse 32: Position error pulse 33: Torque current (%) 34: Magnetic flux command (%) 35: Input watt-hour	Y	Y	19	Y	Y	Y	Y	Y	-
K20	(Bar graph 1 display selection)	1: Output frequency 1 (before slip compensation) 13: Output current 14: Output voltage	Y	Y	1	Y	Y	Y	Y	Y	-
K21	(Bar graph 2 display selection)	18: Calculated torque 19: Input power	Y	Y	13	Y	Y	Y	Y	Y	-
K22	(Bar graph 3 display selection)	25: Load factor 26: Motor output	Y	Y	19	Y	Y	Y	Y	Y	-
K91	(< key shortcut selection)	0: disabled	Y	Y	0	Y	Y	Y	Y	Y	-
K92	(> key shortcut selection)	11 to 99: respective mode	Y	Y	64	Y	Y	Y	Y	Y	-

The keypad function K codes are used when the multi-function keypad (TP-A1-E2C) is connected. For details about the K codes, refer to the instruction manual for the keypad.

5.2.3 Factory default value per applicable electric motor capacitance

Applicable electric motor capacity		Torque boost 1 to 2 F09/ A05	Restart mode after momentary power failure (Restart timer) H13
kW	HP		
0.1	1/8	6.7	0.5
0.2	1/4	4.0	
0.4	1/2	3.5	
0.75	1	6.5	
1.5	2	4.9	
2.2	3	4.5	
3.7	5	4.1	
5.5	7.5	3.4	
7.5	10	2.7	
11	15	2.1	
15	20	1.6	
18.5	25	1.3	
22	30	1.1	
30	40	0.0	
37	50		
45	60		0.0
55	75	1.5	
75	100		
90	125		
110	150		
132	175		
160	200	2.0	
200	250		
220	300	2.5	
280	400		
315	450		4.0
355	500		

5.2.4 Motor constants

[1] When Fuji standard motor 8-series, or other motors are selected by motor selection (Function code P99/ A39 = 0 or 4)

■ 3-phase 200V class, Fuji standard motor

Motor rated capacity setting range (kW) P02/A16	Applicable motor capacity (kW)	Rated current (A) P03/A17 *1	No-load current (A) P06/A20 *1	%R1 (%) P07/A21 *1	%X (%) P08/A22 *1	Rated slip frequency P12/A26	Iron loss factor 1 P13/A27	Starting mode (Auto search delay time 2) H46
0.01 to 0.09	0.06	0.44	0.40	13.79	11.75	1.77	14.00	0.5
0.10 to 0.19	0.1	0.68	0.55	12.96	12.67	1.77	14.00	
0.20 to 0.39	0.2	1.30	1.06	12.95	12.92	2.33	12.60	
0.40 to 0.74	0.4	2.30	1.66	10.20	13.66	2.40	9.88	
0.75 to 1.49	0.75	3.60	2.30	8.67	10.76	2.33	7.40	
1.50 to 2.19	1.5	6.10	3.01	6.55	11.21	2.00	5.85	
2.20 to 3.69	2.2	9.20	4.85	6.48	10.97	1.80	5.91	0.6
3.70 to 5.49	3.7	15.00	7.67	5.79	11.25	1.93	5.24	0.8
5.50 to 7.49	5.5	22.50	11.00	5.28	14.31	1.40	4.75	1.0
7.50 to 10.99	7.5	29.00	12.50	4.50	14.68	1.57	4.03	1.2
11.00 to 14.99	11	42.00	17.70	3.78	15.09	1.07	3.92	1.3
15.00 to 18.49	15	55.00	20.00	3.25	16.37	1.13	3.32	2.0
18.50 to 21.99	18.5	67.00	21.40	2.92	16.58	0.87	3.34	
22.00 to 29.99	22	78.00	25.10	2.70	16.00	0.90	3.28	
30.00 to 36.99	30	107.0	38.90	2.64	14.96	0.80	3.10	2.3
37.00 to 44.99	37	130.0	41.50	2.76	16.41	0.80	2.30	2.5
45.00 to 54.99	45	156.0	47.50	2.53	16.16	0.80	2.18	
55.00 to 74.99	55	190.0	58.60	2.35	16.20	0.94	2.45	2.6
75.00 to 89.99	75	260.0	83.20	1.98	16.89	0.80	2.33	2.8
90.00 to 109.9	90	310.0	99.20	1.73	16.03	0.80	2.31	3.2
110.0 or above	110	376.0	91.20	1.99	20.86	0.66	1.73	3.5

*1: F05: The value for the model, in which the rated voltage at base frequency 1 is not 200V, becomes the optimal value, which is different from the above value.

■ 3-phase 200V class, Fuji standard motor (Cont.)

Motor rated capacity setting range (kW) P02/A16	Magnetic saturation factor 1 P16/A30	Magnetic saturation factor 2 P17/A31	Magnetic saturation factor 3 P18/A32	Magnetic saturation factor 4 P19/A33	Magnetic saturation factor 5 P20/A34	Torque current under vector control P55/A55	Induced voltage factor under vector control P56/A56
0.01 to 0.09	93.8	87.5	75.0	62.5	50.0	0.20	85
0.10 to 0.19	93.3	86.1	74.4	63.6	50.7	0.34	85
0.20 to 0.39	89.7	81.9	66.9	54.5	43.3	0.68	85
0.40 to 0.74	88.7	81.3	67.0	55.2	43.8	1.36	85
0.75 to 1.49	88.3	77.7	62.6	51.8	41.1	2.55	85
1.50 to 2.19	92.1	82.8	71.1	58.1	46.2	5.09	85
2.20 to 3.69	85.1	74.6	61.7	50.3	39.8	7.47	85
3.70 to 5.49	86.0	76.9	61.3	49.5	39.1	12.57	85
5.50 to 7.49	88.6	79.2	64.9	52.7	41.8	18.68	85
7.50 to 10.99	87.7	80.0	67.1	56.1	45.6	25.47	85
11.00 to 14.99	91.3	83.3	69.9	58.0	47.0	37.36	85
15.00 to 18.49	90.5	83.5	72.1	60.7	49.5	50.94	85
18.50 to 21.99	90.7	83.0	70.7	59.9	48.7	62.83	85
22.00 to 29.99	89.7	81.3	68.9	59.1	48.4	74.72	85
30.00 to 36.99	90.2	81.6	68.7	57.2	45.8	101.9	85
37.00 to 44.99	88.7	78.9	65.4	54.2	43.4	125.7	85
45.00 to 54.99	89.0	79.7	66.8	55.4	44.4	152.8	85
55.00 to 74.99	89.2	79.3	64.7	53.6	43.1	186.8	85
75.00 to 89.99	88.1	78.0	64.3	54.2	42.9	254.7	85
90.00 to 109.9	88.8	79.0	65.0	54.0	44.0	305.7	85
110.0 or above	90.5	82.6	70.7	58.7	47.8	373.6	85

■ 3-phase 400V class, Fuji standard motor

Motor rated capacity setting range (kW) P02/A16	Applicable motor capacity (kW)	Rated current (A) P03/A17 *1	No-load current (A) P06/A20 *1	%R1 (%) P07/A21 *1	%X (%) P08/A22 *1	Rated slip frequency P12/A26	Iron loss factor 1 P13/A27	Starting mode (Auto search delay time 2) H46
0.01 to 0.09	0.06	0.22	0.20	13.79	11.75	1.77	14.00	0.5
0.10 to 0.19	0.1	0.35	0.27	12.96	12.67	1.77	14.00	
0.20 to 0.39	0.2	0.65	0.53	12.95	12.92	2.33	12.60	
0.40 to 0.74	0.4	1.15	0.83	10.20	13.66	2.40	9.88	
0.75 to 1.49	0.75	1.80	1.15	8.67	10.76	2.33	7.40	
1.50 to 2.19	1.5	3.10	1.51	6.55	11.21	2.00	5.85	
2.20 to 3.69	2.2	4.60	2.43	6.48	10.97	1.80	5.91	0.6
3.70 to 5.49	3.7	7.50	3.84	5.79	11.25	1.93	5.24	0.8
5.50 to 7.49	5.5	11.50	5.50	5.28	14.31	1.40	4.75	1.0
7.50 to 10.99	7.5	14.50	6.25	4.50	14.68	1.57	4.03	1.2
11.00 to 14.99	11	21.00	8.85	3.78	15.09	1.07	3.92	1.3
15.00 to 18.49	15	27.50	10.00	3.25	16.37	1.13	3.32	2.0
18.50 to 21.99	18.5	34.00	10.70	2.92	16.58	0.87	3.34	
22.00 to 29.99	22	39.00	12.60	2.70	16.00	0.90	3.28	
30.00 to 36.99	30	54.00	19.50	2.64	14.96	0.80	3.10	2.3
37.00 to 44.99	37	65.00	20.80	2.76	16.41	0.80	2.30	2.5
45.00 to 54.99	45	78.00	23.80	2.53	16.16	0.80	2.18	
55.00 to 74.99	55	95.00	29.30	2.35	16.20	0.94	2.45	2.6
75.00 to 89.99	75	130.0	41.60	1.98	16.89	0.80	2.33	2.8
90.00 to 109.9	90	155.0	49.60	1.73	16.03	0.80	2.31	3.2
110.0 to 131.9	110	188.0	45.60	1.99	20.86	0.66	1.73	3.5
132.0 to 159.9	132	224.0	57.60	1.75	18.90	0.66	1.80	4.1
160.0 to 199.9	160	272.0	64.50	1.68	19.73	0.66	1.50	4.5
200.0 to 219.9	200	335.0	71.50	1.57	20.02	0.66	1.36	4.7
220.0 to 249.9	220	365.0	71.80	1.60	20.90	0.58	1.25	
250.0 to 279.9	250	415.0	87.90	1.39	18.88	0.54	1.33	5.0
280.0 to 314.9	280	462.0	93.70	1.36	19.18		1.27	5.5
315.0 to 354.9	315	520.0	120.0	0.84	16.68	0.45	1.81	5.6
355.0 to 399.9	355	580.0	132.0	0.83	16.40	0.43	1.77	
400.0 to 449.9	400	670.0	200.0	0.62	15.67	0.29	1.58	7.5
450.0 to 499.9	450	770.0	270.0	0.48	13.03	0.23	1.84	9.8
500.0 to 559.9	500	835.0		0.51	12.38	0.18	1.80	
560.0 to 629.9	560	940.0		0.57	13.94	0.20	1.61	
630.0 to 709.9	630	1050.0	355.0	0.46	11.77	0.17	1.29	10.5
710.0 or above	710	1150.0	290.0	0.54	14.62	0.21	0.97	

*1: F05: The value for the model, in which the rated voltage at base frequency 1 is not 400V, becomes the optimal value, which is different from the above value.

■ 3-phase 400V class, Fuji standard motor (Cont.)

Motor rated capacity setting range (kW) P02/A16	Magnetic saturation factor 1 P16/A30	Magnetic saturation factor 2 P17/A31	Magnetic saturation factor 3 P18/A32	Magnetic saturation factor 4 P19/A33	Magnetic saturation factor 5 P20/A34	Torque current under vector control P55/A55	Induced voltage factor under vector control P56/A56
0.01 to 0.09	93.8	87.5	75.0	62.5	50.0	0.10	85
0.10 to 0.19	93.3	86.1	74.4	63.6	50.7	0.17	85
0.20 to 0.39	89.7	81.9	66.9	54.5	43.3	0.34	85
0.40 to 0.74	88.7	81.3	67.0	55.2	43.8	0.68	85
0.75 to 1.49	88.3	77.7	62.6	51.8	41.1	1.27	85
1.50 to 2.19	92.1	82.8	71.1	58.1	46.2	2.55	85
2.20 to 3.69	85.1	74.6	61.7	50.3	39.8	3.74	85
3.70 to 5.49	86.0	76.9	61.3	49.5	39.1	6.28	85
5.50 to 7.49	88.6	79.2	64.9	52.7	41.8	9.34	85
7.50 to 10.99	87.7	80.0	67.1	56.1	45.6	12.74	85
11.00 to 14.99	91.3	83.3	69.9	58.0	47.0	18.68	85
15.00 to 18.49	90.5	83.5	72.1	60.7	49.5	25.47	85
18.50 to 21.99	90.7	83.0	70.7	59.9	48.7	31.41	85
22.00 to 29.99	89.7	81.3	68.9	59.1	48.4	37.36	85
30.00 to 36.99	90.2	81.6	68.7	57.2	45.8	50.94	85
37.00 to 44.99	88.7	78.9	65.4	54.2	43.4	62.83	85
45.00 to 54.99	89.0	79.7	66.8	55.4	44.4	76.41	85
55.00 to 74.99	89.2	79.3	64.7	53.6	43.1	93.39	85
75.00 to 89.99	88.1	78.0	64.3	54.2	42.9	127.4	85
90.00 to 109.9	88.8	79.0	65.0	54.0	44.0	152.8	85
110.0 to 131.9	90.5	82.6	70.7	58.7	47.8	186.8	85
132.0 to 159.9	90.3	81.9	69.8	57.8	46.6	211.7	90
160.0 to 199.9	92.2	84.8	71.1	58.6	46.9	256.6	90
200.0 to 219.9	91.9	85.5	72.3	60.0	47.6	320.8	90
220.0 to 249.9	93.1	86.1	72.9	60.8	48.6	352.8	90
250.0 to 279.9	92.2	84.9	72.7	60.5	48.9	400.9	90
280.0 to 314.9	92.7	85.6	72.9	60.9	48.9	449.1	90
315.0 to 354.9	92.7	85.6	72.9	60.9	48.9	505.2	90
355.0 to 399.9	92.7	85.6	72.9	60.9	48.9	569.3	90
400.0 to 449.9	92.7	85.6	72.9	60.9	48.9	641.5	90
450.0 to 499.9	92.7	85.6	72.9	60.9	48.9	721.7	90
500.0 to 559.9	92.7	85.6	72.9	60.9	48.9	801.9	90
560.0 to 629.9	92.7	85.6	72.9	60.9	48.9	898.1	90
630.0 to 709.9	92.7	85.6	72.9	60.9	48.9	1010	90
710.0 or above	92.7	85.6	72.9	60.9	48.9	1139	90

[2] When HP rating motor is selected by motor selection (Function code P99/A39 = 1)**■ 3-phase 200V class, HP rating motor**

Motor rated capacity setting range (HP) P02/A16	Applicable motor Capacity (HP)	Rated current (A) P03/A17	No-load current (A) P06/A20	%R1 (%) P07/A21	%X (%) P08/A22	Rated slip frequency P12/A26	Iron loss factor 1 P13/A27	Starting mode (Auto search delay time 2) H46
0.01 to 0.11	0.1	0.44	0.40	13.79	11.75	2.50	14.00	0.5
0.12 to 0.24	0.12	0.68	0.55	12.96	12.67	2.50	14.00	
0.25 to 0.49	0.25	1.40	1.12	11.02	13.84	2.50	12.60	
0.50 to 0.99	0.5	2.00	1.22	6.15	8.80	2.50	9.88	
1.00 to 1.99	1	3.00	1.54	3.96	8.86	2.50	7.40	
2.00 to 2.99	2	5.80	2.80	4.29	7.74	2.50	5.85	
3.00 to 4.99	3	7.90	3.57	3.15	20.81	1.17	5.91	0.6
5.00 to 7.49	5	12.6	4.78	3.34	23.57	1.50	5.24	0.8
7.50 to 9.99	7.5	18.6	6.23	2.65	28.91	1.17	4.75	1.0
10.00 to 14.99	10	25.3	8.75	2.43	30.78	1.17	4.03	1.2
15.00 to 19.99	15	37.3	12.7	2.07	29.13	1.00	3.92	1.3
20.00 to 24.99	20	49.1	9.20	2.09	29.53	1.00	3.32	2.0
25.00 to 29.99	25	60.0	16.70	1.75	31.49	1.00	3.34	
30.00 to 39.99	30	72.4	19.80	1.90	32.55	1.00	3.28	
40.00 to 49.99	40	91.0	13.60	1.82	25.32	0.47	3.10	2.3
50.00 to 59.99	50	115.0	18.70	1.92	24.87	0.58	2.30	2.5
37.00 to 44.99	60	137.0	20.80	1.29	26.99	0.35	2.18	
75.00 to 99.99	75	174.0	28.60	1.37	27.09	0.35	2.45	2.6
100.0 to 124.9	100	226.0	37.40	1.08	23.80	0.23	2.33	2.8
125.0 to 149.9	125	268.0	29.80	1.05	22.90	0.35	2.31	3.2
150.0 or above	150	337.0	90.40	0.96	21.61	0.39	1.73	3.5

■ 3-phase 200V class, HP rating motor (Cont.)

Motor rated capacity setting range (HP) P02/A16	Magnetic saturation factor 1 P16/A30	Magnetic saturation factor 2 P17/A31	Magnetic saturation factor 3 P18/A32	Magnetic saturation factor 4 P19/A33	Magnetic saturation factor 5 P20/A34	Torque current under vector control P55/A55	Induced voltage factor under vector control P56/A56
0.01 to 0.11	93.8	87.5	75.0	62.5	50.0	0.21	85
0.12 to 0.24	93.3	86.1	74.4	63.6	50.7	0.27	85
0.25 to 0.49	89.7	81.9	66.9	54.5	43.3	0.53	85
0.50 to 0.99	88.7	81.3	67.0	55.2	43.8	1.09	85
1.00 to 1.99	88.3	77.7	62.6	51.8	41.1	2.21	85
2.00 to 2.99	92.1	82.8	71.1	58.1	46.2	4.43	85
3.00 to 4.99	85.1	74.6	61.7	50.3	39.8	6.64	85
5.00 to 7.49	86.0	76.9	61.3	49.5	39.1	11.07	85
7.50 to 9.99	88.6	79.2	64.9	52.7	41.8	16.60	85
10.00 to 14.99	87.7	80.0	67.1	56.1	45.6	22.15	85
15.00 to 19.99	91.3	83.3	69.9	58.0	47.0	33.22	85
20.00 to 24.99	90.5	83.5	72.1	60.7	49.5	44.30	85
25.00 to 29.99	90.7	83.0	70.7	59.9	48.7	55.37	85
30.00 to 39.99	89.7	81.3	68.9	59.1	48.4	66.45	85
40.00 to 49.99	90.2	81.6	68.7	57.2	45.8	88.60	85
50.00 to 59.99	88.7	78.9	65.4	54.2	43.4	110.7	85
37.00 to 44.99	89.0	79.7	66.8	55.4	44.4	132.9	85
75.00 to 99.99	89.2	79.3	64.7	53.6	43.1	166.1	85
100.0 to 124.9	88.1	78.0	64.3	54.2	42.9	221.5	85
125.0 to 149.9	88.8	79.0	65.0	54.0	44.0	276.9	85
150.0 or above	90.5	82.6	70.7	58.7	47.8	332.2	85

■ 3-phase 400V class, HP rating motor

Motor rated capacity setting range (HP) P02/A16	Applicable motor Capacity (HP)	Rated current (A) P03/A17	No-load current (A) P06/A20	%R1 (%) P07/A21	%X (%) P08/A22	Rated slip frequency P12/A26	Iron loss factor 1 P13/A27	Starting mode (Auto search delay time 2) H46
0.01 to 0.11	0.1	0.22	0.20	13.79	11.75	2.50	14.00	0.5
0.12 to 0.24	0.12	0.34	0.27	12.96	12.67	2.50	14.00	
0.25 to 0.49	0.25	0.70	0.56	11.02	13.84	2.50	12.60	
0.50 to 0.99	0.5	1.00	0.61	6.15	8.80	2.50	9.88	
1.00 to 1.99	1	1.50	0.77	3.96	8.86	2.50	7.40	
2.00 to 2.99	2	2.90	1.40	4.29	7.74	2.50	5.85	
3.00 to 4.99	3	4.00	1.79	3.15	20.81	1.17	5.91	0.6
5.00 to 7.49	5	6.30	2.39	3.34	23.57	1.50	5.24	0.8
7.50 to 9.99	7.5	9.30	3.12	2.65	28.91	1.17	4.75	1.0
10.00 to 14.99	10	12.7	4.37	2.43	30.78	1.17	4.03	1.2
15.00 to 19.99	15	18.7	6.36	2.07	29.13	1.00	3.92	1.3
20.00 to 24.99	20	24.6	4.60	2.09	29.53	1.00	3.32	2.0
25.00 to 29.99	25	30.0	8.33	1.75	31.49	1.00	3.34	
30.00 to 39.99	30	36.2	9.88	1.90	32.55	1.00	3.28	
40.00 to 49.99	40	45.5	6.80	1.82	25.32	0.47	3.10	2.3
50.00 to 59.99	50	57.5	9.33	1.92	24.87	0.58	2.30	2.5
60.00 to 74.99	60	68.7	10.4	1.29	26.99	0.35	2.18	
75.00 to 99.99	75	86.9	14.3	1.37	27.09	0.35	2.45	2.6
100.0 to 124.9	100	113.0	18.7	1.08	23.80	0.23	2.33	2.8
125.0 to 149.9	125	134.0	14.9	1.05	22.90	0.35	2.31	3.2
150.0 to 174.9	150	169.0	45.2	0.96	21.61	0.39	1.73	3.5
175.0 to 199.9	175	188.5	45.2	0.96	21.61	0.39	1.80	4.1
200.0 to 249.9	200	231.0	81.8	0.72	20.84	0.23	1.50	4.5
250.0 to 299.9	250	272.0	41.1	0.71	18.72	0.35	1.36	4.7
300.0 to 324.9	300	323.0	45.1	0.53	18.44	0.23	1.25	
325.0 to 349.9	325	342.9	45.1	0.53	18.44	0.23	1.33	5.0
350.0 to 399.9	350	375.0	68.3	0.99	19.24	0.46	1.27	5.5
400.0 to 449.9	400	429.0	80.7	1.11	18.92	0.46	1.81	5.6
450.0 to 499.9	450	481.0	85.5	0.95	19.01	0.48	1.77	
500.0 to 599.9	500	534.0	99.2	1.05	18.39	0.45	1.58	7.5
600.0 to 699.9	600	638.0	140.0	0.85	18.38	0.39	1.84	9.8
700.0 to 749.9	700						1.70	
750.0 to 799.9	750							
800.0 or above	800						10.5	

■ 3-phase 400V class, HP rating motor (Cont.)

Motor rated capacity setting range (HP) P02/A16	Magnetic saturation factor 1 P16/A30	Magnetic saturation factor 2 P17/A31	Magnetic saturation factor 3 P18/A32	Magnetic saturation factor 4 P19/A33	Magnetic saturation factor 5 P20/A34	Torque current under vector control P55/A55	Induced voltage factor under vector control P56/A56
0.01 to 0.11	93.8	87.5	75.0	62.5	50.0	0.10	85
0.12 to 0.24	93.3	86.1	74.4	63.6	50.7	0.13	85
0.25 to 0.49	89.7	81.9	66.9	54.5	43.3	0.27	85
0.50 to 0.99	88.7	81.3	67.0	55.2	43.8	0.55	85
1.00 to 1.99	88.3	77.7	62.6	51.8	41.1	1.11	85
2.00 to 2.99	92.1	82.8	71.1	58.1	46.2	2.21	85
3.00 to 4.99	85.1	74.6	61.7	50.3	39.8	3.32	85
5.00 to 7.49	86.0	76.9	61.3	49.5	39.1	5.54	85
7.50 to 9.99	88.6	79.2	64.9	52.7	41.8	8.30	85
10.00 to 14.99	87.7	80.0	67.1	56.1	45.6	11.07	85
15.00 to 19.99	91.3	83.3	69.9	58.0	47.0	16.61	85
20.00 to 24.99	90.5	83.5	72.1	60.7	49.5	22.15	85
25.00 to 29.99	90.7	83.0	70.7	59.9	48.7	27.69	85
30.00 to 39.99	89.7	81.3	68.9	59.1	48.4	33.22	85
40.00 to 49.99	90.2	81.6	68.7	57.2	45.8	44.30	85
50.00 to 59.99	88.7	78.9	65.4	54.2	43.4	55.37	85
60.00 to 74.99	89.0	79.7	66.8	55.4	44.4	66.45	85
75.00 to 99.99	89.2	79.3	64.7	53.6	43.1	83.06	85
100.0 to 124.9	88.1	78.0	64.3	54.2	42.9	110.7	85
125.0 to 149.9	88.8	79.0	65.0	54.0	44.0	138.4	85
150.0 to 174.9	90.5	82.6	70.7	58.7	47.8	166.1	85
175.0 to 199.9	90.3	81.9	69.8	57.8	46.6	183.0	90
200.0 to 249.9	92.2	84.8	71.1	58.6	46.9	209.2	90
250.0 to 299.9	91.9	85.5	72.3	60.0	47.6	261.5	90
300.0 to 324.9	93.1	86.1	72.9	60.8	48.6	313.8	90
325.0 to 349.9	92.2	84.9	72.7	60.5	48.9	339.9	90
350.0 to 399.9	92.7	85.6	72.9	60.9	48.9	366.1	90
400.0 to 449.9	92.7	85.6	72.9	60.9	48.9	418.4	90
450.0 to 499.9	92.7	85.6	72.9	60.9	48.9	470.7	90
500.0 to 599.9	92.7	85.6	72.9	60.9	48.9	523.0	90
600.0 to 699.9	92.7	85.6	72.9	60.9	48.9	627.6	90
700.0 to 749.9	92.7	85.6	72.9	60.9	48.9	732.2	90
750.0 to 799.9	92.7	85.6	72.9	60.9	48.9	784.0	90
800.0 or above	92.7	85.6	72.9	60.9	48.9	837.0	90

5.3 Description of Function Codes

This section describes details of function code. In principle, explanation is given for each function code in order of group and numerical order. However, function codes that are strongly related to one function are explained together in the first paragraph.

5.3.1 F codes (Basic functions)

F00	Data protection
------------	------------------------

This is a function to protect currently set data by disabling to make changes in function code data (except F00) and all types of command values (frequency setting, PID command) by $\triangleleft/\triangleright$ key operation from keypad.

F00 data	Change of function code		Changing digital reference data with the $\triangleleft/\triangleright$ keys
	Change from keypad	Change from communication	
0	Allowed	Allowed	Allowed
1	Not allowed *	Allowed	Allowed
2	Allowed	Allowed	Not allowed
3	Not allowed *	Allowed	Not allowed

*Although it is not possible to change function code from keypad, function code F00 can be changed.

F00 data can be changed by the double key operation using “ STOP key + \triangleleft key” or “ STOP key + \triangleright key”.

As a similar function related to data protection, “Allow function code editing (Data change enabled) ‘WE-KP’” which can be assigned to a digital input terminal is available (📖 Function code E01 to E05 Data = 19).

By combining data protection F00, protection of function code functions as follows:

Input signal “WE-KP”	Change in function code	
	Change from keypad	Change from communication
OFF	Not allowed	Allowed
ON	Follow setting of F00	



- If “enable data change with keypad” [WE-KP] is set to a digital input terminal by mistake, it is not possible to make changes in function codes. In this case, after shortening (ON) the terminal to which temporarily “WE-KP” function is assigned, and the terminal [CM], change to a different function.
- “WE-KP” is the change enable signal for function code, this is not the function to protect frequency setting and PID command by $\triangleleft/\triangleright$ key operation.

F01	Frequency setting 1 Related function codes: F18 bias (for frequency setting 1) C30 frequency setting 2 C31 to C35 analog input adjustment (Terminal [12]) C36 to C39 analog input adjustment (Terminal [C1] (C1 function)) C40 terminal [C1] (C1 function) (Range / polarity selection) C41 to C45 analog input adjustment (Terminal [C1] (V2 function)) C55 to C56 analog input adjustment (Terminal [12]) (Bias-Bias base point) C61 to C62 analog input adjustment (Terminal [C1] (C1 function) (Bias-Bias base point) C67 to C68 analog input adjustment (Terminal [C1] (V2 function)) (Bias-Bias base point) C50 bias (for frequency setting 1) (Bias base point) H61 UP/DOWN control initial value selection d59, d61 to d63 Command (Pulse train input)
------------	---

Select setting method of frequency setting. Set frequency setting 1 by function code F01, frequency setting 2 by C30.

F01, C30 data	Command sources
0	Frequency setting by keypad (refer to the following descriptions to find the setting method)
1	Set by voltage value to be input in the terminal [12] (0 to ± 10 VDC, Maximum output frequency /DC ± 10 V)
2	Setting by current value to be input in the terminal [C1] (C1 function) (4 to 20mADC or 0 to 20 mADC, Maximum output frequency / 20 mADC) (Set slide switch SW4 of printed circuit board to [AI] side (factory default state), SW3 to [C1] side (factory default state), respectively.) (It is necessary to select C1 function (factory default state) by E59=0) (It is necessary to disable PTC input function by H26=0)
3	Set by the addition result of voltage value to be input in the terminal [12] (0 to ± 10 VDC, Maximum output frequency / ± 10 VDC) and current value to be input in the terminal [C1] (C1 function) (4 to 20 mA DC or 0 to 20 mA DC, Maximum output frequency/20 mA DC) When the addition result becomes maximum output frequency or higher, it is restricted by the maximum output frequency)
5	Set by voltage value to be input in the terminal [C1] (V2 function) (0 to +10 VDC, Maximum output frequency /+10 VDC) (Set slide switch SW4 of printed circuit board to [AI] side (factory default state), SW3 to [V2] side, respectively.) (It is necessary to select V2 function by E59 = 1) (It is necessary to disable PTC input function by H26 = 0)
7	Set by UP command "UP" and DOWN command "DOWN" assigned to the digital input terminal It is necessary to assign UP command (Data = 17) and DOWN command (Data =18) to the digital input terminal [X1] to [X5]. (E01 toE05)
8	Frequency setting by keypad (with balanceless bumpless function)
10	Set by pattern operation (C21 to C28)
11	Enable a digital input/output interface card (option). (For details, refer to the Digital Input Output Interface Card Instruction Manual.)
12	Setting by pulse train input "PIN" (Data = 48), which was assigned to the digital input terminal [X5], or the optional PG interface card. Note: When using X5 terminal with pulse train input, it might be affected by noise from other wire. Keep away from other wire from the wire to X5 terminal as far as possible.

Setting method of reference frequency

[1] Frequency setting by keypad (F01 = 0 (Factory default state), 8)

- (1) Set the data of function code F01 to "0" or "8". When keypad is at program mode or alarm mode, it is not possible to perform frequency setting with \triangle/∇ keys. In order to enable frequency setting with \triangle/∇ keys, shift to the operation mode.
- (2) When \triangle/∇ key is pressed, reference frequency is displayed and the least significant digit of the reference frequency flashes.
- (3) By pressing the \triangle/∇ key again, it is possible to change the reference frequency. To save the set frequency, press FUNC DATA key. (E64=0: Factory default state). When the frequency is saved, it is possible to operate with the saved frequency next time the power is turned on.



- Automatic saving method (Function code E64 = 0) is available other than the above method as a data saving method of frequency setting.
- While the data of function code F01 is set to "0" or "8", when frequency setting method other than frequency setting 1 (frequency setting 2, communication, multistep frequency) is selected as frequency setting, it is not possible to change the reference setting with \triangle/∇ keys even if keypad is at operation mode. In this case, pressing \triangle/∇ keys displays the currently selected reference frequency.
- When frequency setting is performed with \triangle/∇ keys, the least significant digit displayed flashes and the data is changed from the least significant digit and the changing digit gradually shifts to the upper digit.
- In order to perform setting such as reference frequency, press \triangle/∇ once and when the least significant digit flashes, push down the \triangleright key, and then, the flashing digit will move. Therefore, it is possible to change the large numerical number easily. This operation is called cursor movement.
- When the data of function code F01 is set to "8", balanceless bumpless function becomes enabled. When switching to frequency setting with keypad from frequency setting method other than keypad, the switched initial value of frequency setting with keypad takes the value of the frequency setting before it is switched. By using this function, even if frequency setting is switched, it is possible to perform operation without shock.

[2] Setting up a reference frequency using analog input (F01 = 1 to 3, 5)

It is possible to arbitrarily specify a frequency setting from the analog inputs (voltage value to be input to terminal [12] or terminal [C1] (V2 function) or current value to be input to terminal [C1] (C1 function)) by multiplying them with the gain and adding the bias. The polarity can be selected and the filter time constant and offset can be adjusted.

Adjustment constants of frequency setting 1

F01 data	Input terminal	Input range	Bias		Gain		Polarity selection	Filter	Offset
			Bias	Base point	Gain	Base point			
1	[12]	0 to +10V, -10 to +10V	F18	C50	C32	C34	C35	C33	C31
2	[C1] (C1 function)	4 to 20 mA 0 to 20 mA	F18	C50	C37	C39	C40	C38	C36
3	[12]+ [C1] (C1 function) (Set by result of addition)	0 to +10V, -10 to +10V	F18	C50	C32	C34	C35	C33	C31
		4 to 20 mA 0 to 20 mA	F18	C50	C37	C39	C40	C38	C36
5	[C1] (V2 function)	0 to +10V	F18	C50	C42	C44	C45	C43	C41

Adjustment constants of frequency setting 2

C30 data	Input terminal	Input range	Bias		Gain		Polarity selection	Filter	Offset
			Bias	Base point	Gain	Base point			
1	[12]	0 to +10V, -10 to +10V	C55	C56	C32	C34	C35	C33	C31
2	[C1] (C1 function)	4 to 20 mA 0 to 20 mA	C61	C62	C37	C39	C40	C38	C36
3	[12]+ [C1] (C1 function) (Set by result of addition)	0 to +10V, -10 to +10V	C55	C56	C32	C34	C35	C33	C31
		4 to 20 mA 0 to 20 mA	C61	C62	C37	C39	C40	C38	C36
5	[C1] (V2 function)	0 to +10V	C67	C68	C42	C44	C45	C43	C41

■ **Offset (C31, C36, C41)**

C31, C36 or C41 configures an offset for an analog voltage/current input. The offset also applies to signals sent from the external equipment.

■ **Filter (C33, C38, C43)**

C33, C38, and C43 provide the filter time constants for the voltage and current of the analog input. The larger the time constant, the slower the response. Specify the proper filter time constant taking into account the response speed of the machine (load). If the input voltage fluctuates due to line noises, increase the time constant.

■ **Terminal [12] Polarity selection (C35)**

C35 configures the polarity and therefore the input range for analog input voltage.

C35 data	Modes for terminal inputs
0	-10 to +10 V
1	0 to +10 V (Negative value of voltage is regarded as 0 V)

■ Terminal [C1] (C1 function) range / polarity selection (C40)

C40 data	Terminal input range	Handling when bias value is set to minus
0	4 to 20 mA (Factory default)	Limit below 0 point with 0
1	0 to 20mA	
10	4 to 20mA	Enable below 0 point as minus value.
11	0 to 20mA	

■ Terminal [C1] (V2 function) polarity selection (C45)

C45 data	Modes for terminal inputs
0	0 to +10V When bias value is set to minus, enable below 0 point as a minus value.
1	0 to +10V (factory default) When bias value is set to minus, limit below 0 point by 0.

In order to use [C1] terminal as C1 function, V2 function, and PTC function, the following setting are necessary.

[C1] terminal	SW3	SW4	E59	H26	C40
When using C1 function (4 to 20 mA)	C1 side	AI side	0	0	0,10
When using C1 function (0 to 20 mA)	C1 side	AI side	0	0	1,11
When using V2 function (0 to +10V)	V2 side	AI side	1	0	Not relevant
When using PTC function	C1 side	PTC side	Not relevant	1, 2	Not relevant

For details of SW3 and SW4, refer to Chapter 2, Section 2.2.8.

Caution is necessary because if the above switch settings are not performed accurately, unexpected frequency setting may be performed for the inverter.

■ Gain-Bias

Terminal	<Frequency setting 1: F01>	<Frequency setting 2: C30>
[12]		
[C1] (C1 function)		
[C1] (V2 function)		

Note For [12] + [C1] (C1 function) (setting by the result of addition), bias and gain are reflected to [12] and [C1] (C1 function) individually, and added by frequency command value of the result.

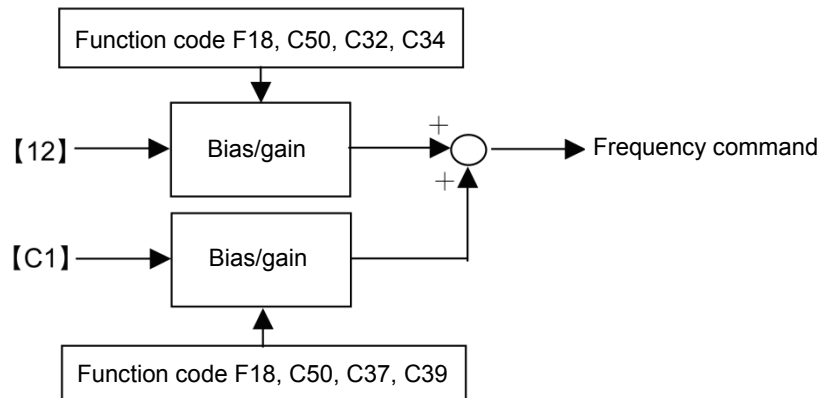

For single polarity (Terminal [12] (C35=1), Terminal [C1] (C1 function), Terminal [C1] (V2 function)

As the above diagram indicates, for reference frequency and analog input of frequency setting 1, it is possible to set arbitrary relationship by A point (determined by bias (F18) and bias reference point (C50)) and B point (determined by the gain corresponding to each analog input and the gain reference point (C32 and C34, C37 and C39, and C42 and C44)).

For reference frequency and analog input of frequency setting 2 (C30), it is possible to set arbitrary relationship by A point (determined by bias and bias reference point (C55 and C56, C61 and C62, and C67 and C68)) and B point (determined by the gain corresponding to each analog input and the gain reference point (C32 and C34, C37 and C39, and C42 and C44)).

Both data of bias and gain are set with 100% as the maximum frequency. The data of bias reference point and gain reference point are set up with full scale of analog input (10V or 20mA) as 100%.

By setting the bias to minus value, even if the analog input is unipolar, it is possible to perform frequency setting as bipolar. For terminal [C1] (C1 function), C40 is set to 10 or 11, and for terminal [C1] (V2 function), C45 is set to 1, and then, the frequency setting at analog input at or below 0 point becomes negative polarity, as a result, it becomes possible to perform forward and reverse operation only by analog command.



<Frequency setting 1: F01>

- Analog input at or below bias reference point (C50) is restricted by bias value (F18).
- When the value set in bias reference point (C50) \geq each gain reference point (C34, C39, C44), it is judged as incorrect setting and reference point becomes 0 Hz.

<Frequency setting 2: C30>

- Analog input at or below bias reference point (C56, C62, and C68) is restricted by bias value (C55, C61 and C67).
- When the value set in bias reference point (C56, C62, C68) \geq each gain reference point (C34, C39, C44), it is judged as incorrect setting and reference point becomes 0 Hz.

Example) When setting reference frequency to 0 to 60 Hz by analog input (terminal [12]) 1 to 5V (When maximum frequency is F03=60 Hz)

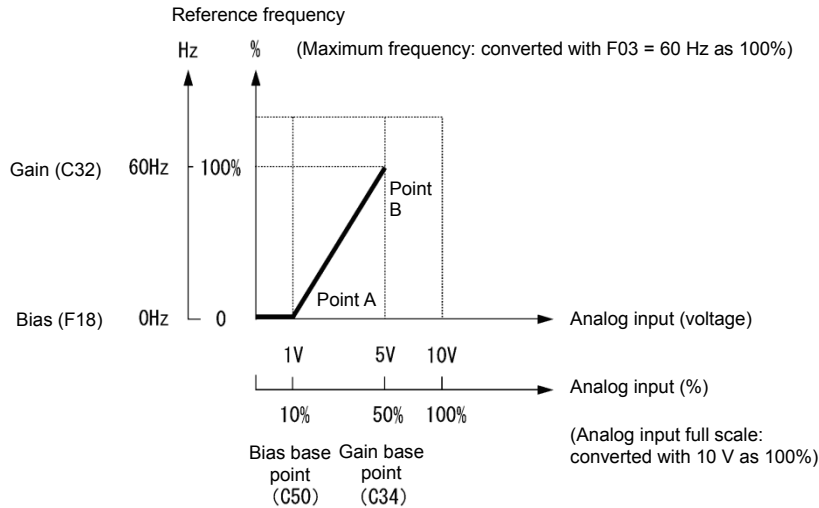

(A point)

In order to set reference frequency to 0 Hz when analog input is 1V, set bias (F18) to 0%. At this point, 1V has to become the bias reference point and 1V is equivalent to 10% against full scale 10V of terminal [12], therefore, set the bias reference point (C50) to 10%.

(B point)

In order to set reference frequency so that the frequency becomes the highest when analog input is 5V, set the gain (C32) to 100%. At this point, 5V has to become the gain reference point and 5V is equivalent to 50% against full scale 10V of terminal [12], therefore, set the gain reference point (C34) to 50%.



The setting method without changing reference point and by using gain and bias individually is the same as for Fuji electric inverter of old model.

For bipolar (Terminal [12] (C35=0))

For terminal [12], by setting function code C35 to "0", it is possible to use bipolar input (-10V to +10V).

When both bias (F18) and bias reference point (C50) are set to "0", command becomes forward and reverse symmetric as shown in the diagram below.

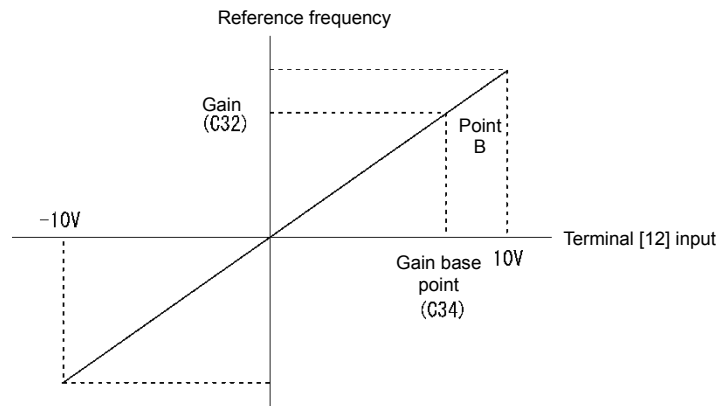

- When bias (F18) and bias reference point (C50) is set to arbitrary value (A1 point, A2 point, and A3 point, etc.), as shown in the diagram below, it is determined by the bias value (F18).

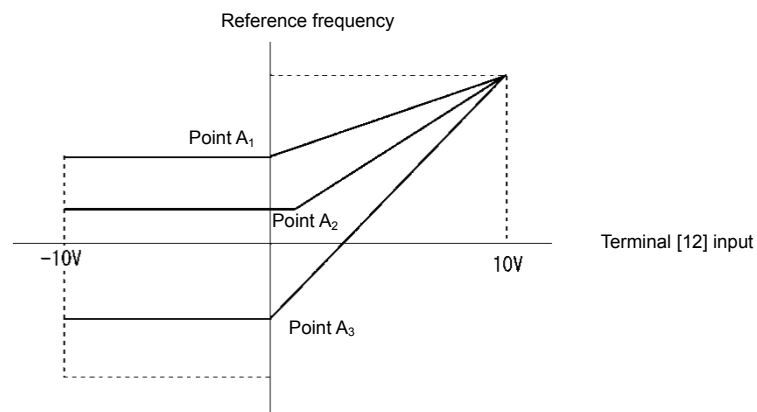

- To input bipolar (0 to ± 10 VDC) analog voltage at analog input (terminal [12]), set function code C35 to "0". When the data of C35 is "1", only DC 0 to +10V is effective and negative polar input DC0 to -10V is regarded as 0 (Zero) V.
- When setting reference frequency by display other than frequency (Hz), please change the speed monitor unit in E48.

When operating unipolar analog input as bipolar (terminal [C1] (C1 function) (C40 = 10, 11), terminal [C1] (V2 function) (C45 = 0)

For C1 function set C40 = 10, 11, for V2 function set C45 = 0, and by setting bias value to minus value, it is possible to obtain a negative reference frequency.

Example of frequency setting by V2 function when -100% is set to the bias value is shown in the diagram below.

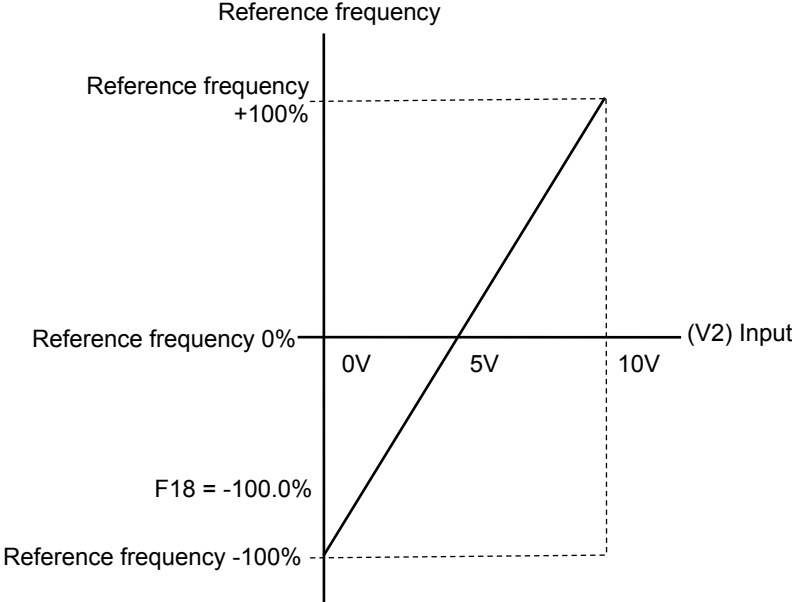

[3] Frequency setting by digital input signal “UP”/“DOWN” (F01=7)

As frequency setting, UP/DOWN control is selected, and when the terminal command UP or DOWN is turned on with Run command ON, the output frequency increases or decreases accordingly, within the range from 0 Hz to the maximum frequency.

To perform frequency setting by UP/DOWN control, it is necessary to set the data of function code F01 to “7” and assign “UP command [UP], down command [DOWN]” to the digital input terminals.

(📖 Function code E01 to E05 Data = 17, 18)

Input signal “UP” Data = 17	Input signal “DOWN” Data = 18	Action
OFF	OFF	The output frequency will be held
ON	OFF	Increase output frequency by currently selected acceleration time
OFF	ON	Decrease output frequency by currently selected deceleration time
ON	ON	The output frequency will be held

■ UP/DOWN control initial value selection

Set initial value of reference frequency when starting UP/DOWN control.

H61 data	Initial value of frequency setting when starting UP/DOWN control.
0	Mode to fix to “0” When restarting operation (including when the power to the inverter is turned ON), initial value of setting frequency by UP/DOWN control is cleared with “0”. Increase speed by UP command.
1	This is the mode to set reference frequency at the previous UP/DOWN control as the initial value. The inverter internally holds the output frequency set by UP/DOWN control and starts to control from the previous operation frequency at the next restart (including powering ON).

Note At the restart of operation, before the internal frequency reaches the previous output frequency, when UP/DOWN command is input, output frequency at the point is held internally and UP/DOWN control starts from that value. Therefore, the previous output frequency data is overwritten and deleted.

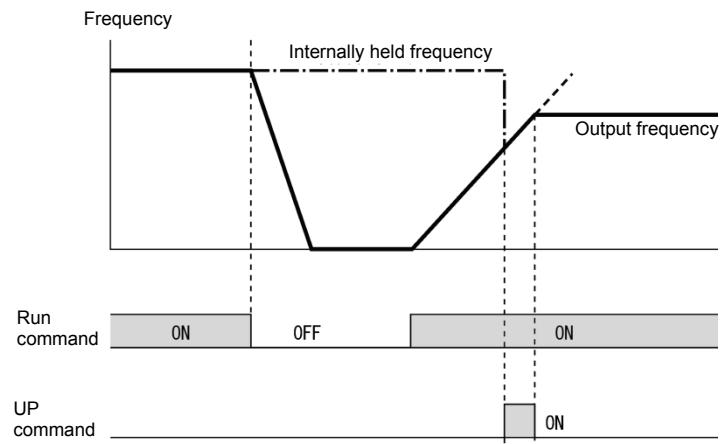

< Initial value of UP/DOWN control when setting method of frequency setting is switched >

The initial value when setting method of frequency setting is set to UP/DOWN control is shown in the following table.

Setting method prior to switching	Switching signal	Initial value of UP/DOWN control	
		H61=0	H61=1
Setting other than UP/DOWN (F01, C30)	Frequency setting 2/ Frequency setting 1	Reference frequency by setting method prior to switching	
PID control	PID Cancel	Reference frequency by PID control (PID output)	
Multistep frequency	Multistep frequency selection	Reference frequency by setting method prior to switching	Reference frequency by previous UP/DOWN control
Communication	Link operation selection		

[4] Frequency setting using digital inputs (option DIO interface card) (F01 = 11)

The frequency setting with binary (8,12bit) or BCD code via option DIO interface card (OPC-DIO) is also available to be selected. Refer to the Digital Input Output Interface Card Instruction Manual.

[5] Frequency setting using pulse train input (F01 = 12)

■ Selecting the pulse train input format (d59)

A pulse train in the format selected by the function code d59 can give a frequency command to the inverter. Three types of formats are available; the pulse train sign/pulse train input, the forward rotation pulse/reverse rotation pulse, and the A and B phases with 90 degree phase difference. If no optional PG interface card is mounted, the inverter ignores the setting of the function code d59 and accepts only the pulse train sign/pulse train input.

The table below lists pulse train formats and their operations.

Pulse train input format selected by d59	Operation overview
0: Frequency and direction	Frequency/speed command according to the pulse train rate is given to the inverter. The pulse train sign specifies the polarity of the frequency/speed command. <ul style="list-style-type: none"> For the inverter without an optional PG interface card Pulse train input: "PIN" assigned to the digital terminal [X5] (data = 48) Pulse train sign: "SIGN" assigned to a digital terminal other than [X5] (data = 49) If no SIGN is assigned, polarity of any pulse train input is positive.
1: Forward and reverse pulse	Frequency/speed command according to the pulse train rate is given to the inverter. The forward rotation pulse gives a frequency/speed command with positive polarity, and a reverse rotation pulse, with negative polarity.
2: Quadrature A/B signals (B phase lead)	Pulse trains generated by A and B phases with 90 degree phase difference give a frequency/speed command to the inverter based on their pulse rate and the phase difference (B phase advanced).
3: Quadrature A/B signals (A phase lead)	When YA, YB are connected in reverse, if you change this function code, the inverter can receive the pulse signal correctly.

Format of data 1 to 3 refer to d14.

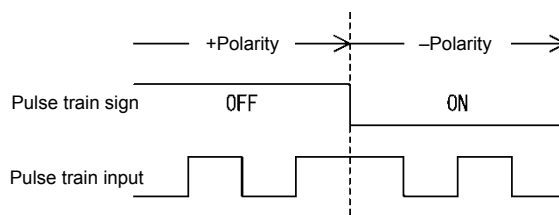

Figure 5.3-1 Data 0, pulse train sign/Pulse train input.

■ **Pulse scaling factor 1 (d62), pulse scaling factor 2 (d63)**

For pulse train input, set the relationship between input pulse frequency and frequency setting value by function code d62 (Command (pulse train input) pulse scaling factor 1) and d63 (command (pulse train input) pulse scaling factor 2).

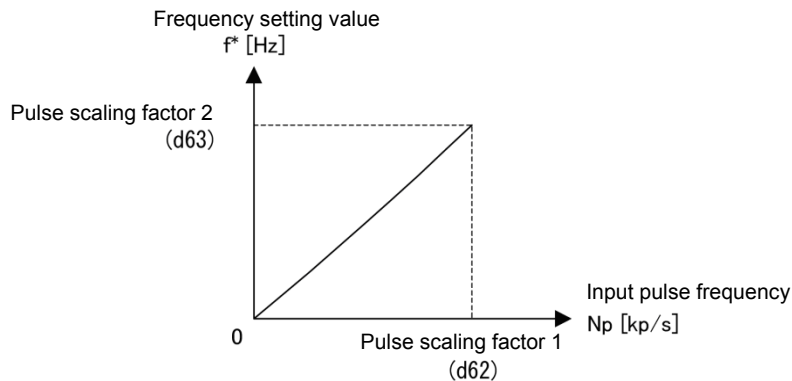

Figure 5.3-2 Relationship between input pulse frequency and frequency setting value

As shown in the figure above, set input pulse frequency [kp/s] to function code d62 (command (pulse train input) pulse scaling factor 1) and set frequency setting value [Hz] (when the input pulse frequency becomes the value set to function code d62) to function code d63 (command (pulse train input) pulse scaling factor 2). At this time, the relationship formula of input pulse frequency to be entered and frequency setting value f^* (or speed command value) is as follows:

$$f^* \text{ [Hz]} = N_p \text{ [kp/s]} \times \frac{\text{Pulse scaling factor 2 (d63)}}{\text{Pulse scaling factor 1 (d62)}}$$

f^* [Hz]: Frequency setting value

N_p [kp/s]: Input pulse frequency to be input

Depending on the pulse train sign, polarity of the command is determined. Rotation direction of the motor is determined by the polarity of pulse train input and “FWD”/“REV” command. The relationship between the pulse train input polarity and rotation direction is specified in Table 5.3-1.

Table 5.3-1 The relationship between the pulse train input polarity and rotation direction

Polarity according to the pulse train input	Run command	Rotational direction
+	“FWD” (Forward rotation command)	Forward rotation
+	“REV” (Reverse rotation command)	Reverse rotation
-	“FWD” (Forward rotation command)	Reverse rotation
-	“REV” (Reverse rotation command)	Forward rotation

■ **Filter time constant (d61)**

Set filter time constant for pulse train input. The larger the time constant, the slower the response. Specify the proper filter time constant by taking into account the response speed of the machine. If the pulse is lower and frequency command fluctuates, set larger time constant.

■ **Switching frequency setting**

Switch frequency setting 1 (F01) and frequency setting 2 (C30) by the signal “Frequency setting 2/frequency setting 1” “Hz2/ Hz1”, which was assigned to the external digital input terminal.

(Refer to Function code E01 to E05 (Data =11) to find the details of “Hz2/ Hz1”).

Input signal “Hz2/ Hz1”	Frequency setting method to be selected
OFF	Frequency setting 1 (F01)
ON	Frequency setting 2 (C30)

F02	Operation method
------------	-------------------------

Select setting method of run command. Indicate instruction method of run/stop and rotation direction (forward/reverse rotation) for each setting method.

F02 data	Setting method of run command	
	Run/stop	Rotation direction command
0: Keypad operation (Rotation direction input: Terminal block)	keys	“FWD”, “REV”
1: External signal (digital input)	“FWD”, “REV”	
2: Keypad operation (forward rotation)	keys	Rotation direction command is unnecessary (Forward rotation operation only, reverse rotation operation disabled)
3: Keypad operation (Reverse rotation)	keys	Rotation direction command is unnecessary (Reverse rotation operation only, forward rotation operation disabled)

Digital input signal, “FWD”, “REV” needs to be assigned to terminals [FWD], [REV].

Function code E98, E99 data = 98, 99



- F02 cannot be changed when “FWD” or “REV” is ON.
- If F02 = 1 and when assignment of terminal [FWD] or [REV] is changed from other function to “FWD” function or “REV” function, turn the terminal [FWD] and [REV] off in advance (motor may rotate due to change in the setting).

■ **3-wire operation by external signal**

Although external signal of “FWD” and “REV” is 2-wire operation at the initial state, by assigning “Select 3-wire operation (HLD)”, it is possible to use as self-hold signal at 3-wire operation by using “FWD”, “REV” and “HLD” signals. When “HLD” is ON, inverter self-holds “FWD” or “REV” signal, and the hold state can be released by OFF. If there is no “HOLD” function assignment, “FWD” and “REV” become 2-wire operation.

Refer to Function code E01 to E05 (Data =6) to find the details of “HLD”.

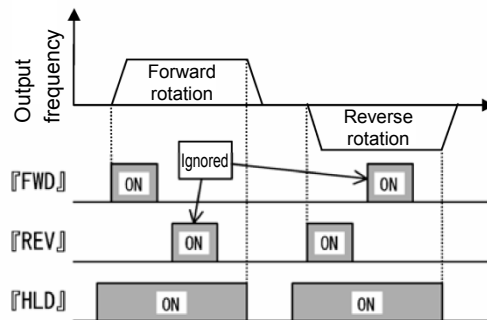

As a setting method of run command, high-priority setting methods (remote/local switch (refer to Chapter 3, Section 3.3.7), communication, etc.) are available in addition to the above mentioned settings.

F03**Maximum frequency 1**

F03 specifies the maximum frequency that the inverter outputs. When the device to be driven is set to rated or higher, the device may be damaged. Make sure to make an adjustment to design mode value of the machinery.

- Data setting range: 25.0 to 500.0 (Hz)

Modes	Control mode	Data setting range	Remarks
HD/HND/HHD mode	V/f control	500 Hz	
ND mode	V/f control	120 Hz	Restricted internally.*

* When setting is performed by exceeding the maximum setting range (for example, 500 Hz), speed setting and analog output (FMA) become input/output mode of full scale/setting value (10V/ 500Hz). However, it is internally restricted (for example, 120Hz), therefore, even if 10V is input for setting value, the value is restricted internally by 2.4 V (equivalent to 120 Hz), not by 500Hz.

Use function code F80 to switch between ND, HD, HND and HHD drive modes.

⚠ WARNING

Inverter can perform setting of high speed operation easily. When changing the setting, make sure to check the motor and machine mode before use.

Injuries could occur. Failure may occur.



When changing maximum output frequency (F03) in order to make the operation frequency a larger value, change the frequency limiter (upper limit) (F15) as well.

F04, F05 F06	Base frequency 1, Rated voltage at base frequency 1 Maximum output voltage 1 Related function codes: H50, H51 Non-linear V/f 1 (Frequency, voltage) H52, H53 Non-linear V/f 2 (Frequency, voltage) H65, H66 Non-linear V/f 3 (Frequency, voltage)
-------------------------	--

Set the base frequency and base frequency voltage that are essential to operation of the motor. By combining related function codes H50 to H53, H65, and H66, it is possible to set non-linear V/f pattern (weak or strong voltage by arbitrary point) and perform setting of V/f characteristics that is suitable for the load.

Impedance of the motor becomes larger with high frequency, and when output voltage becomes less, output torque may be reduced. In order to prevent this, increase the voltage at high frequency by setting function code F06 (maximum output voltage 1). However, it is not possible to output voltage at or higher than the input power voltage of the inverter.

Point of V/f	Function code		Remarks
	Frequency	Voltage	
Maximum output frequency	F03	F06	During auto torque boost, vector control with/ without speed sensor, the maximum output voltage setting is disabled.
Base frequency	F04	F05	
Non-linear V/f 3	H65	H66	This code is disabled during auto torque boost, vector control with/ without speed sensor.
Non-linear V/f 2	H52	H53	
Non-linear V/f 1	H50	H51	

<Setting example>

■ **Normal V/f pattern setting**

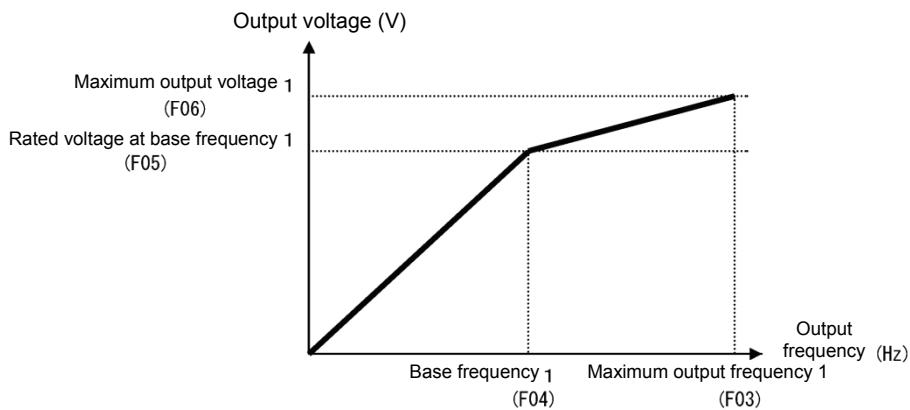

■ **Non-linear V/f pattern setting (3 points)**

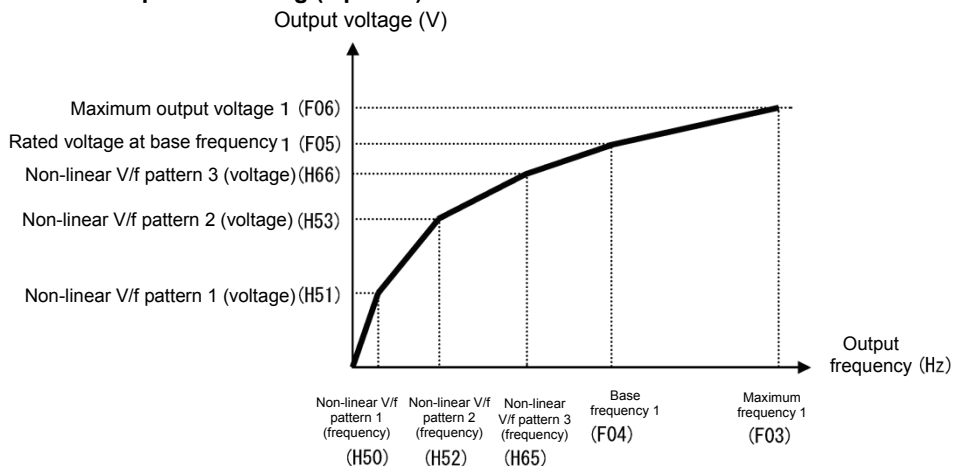

■ Base frequency (F04)

Set the data in accordance with rated frequency of the motor (given on the nameplate of the motor).

- Data setting range: 25.0 to 500.0 (Hz) (limited to 120 Hz (max.) in ND mode)

■ Rated voltage at base frequency (F05)

Set the data to "0" in accordance with rated voltage of the motor (given on the nameplate of the motor).

- Data setting range: 0 : AVR disable
80 to 240 (V) : AVR operation (at 200 V class)
160 to 500 (V) : AVR operation (at 400 V class)
- When data is set to "0", the base frequency voltage becomes equivalent to inverter input voltage. When input voltage fluctuates, output voltage fluctuates as well.
- When data is set to arbitrary voltage other than "0", automatically keeps the output voltage constant. When control function such as auto torque boost, auto energy-saving operation, and skip compensation is used, it is necessary to adjust to the rated voltage (given on the nameplate of the motor) of the motor.

 **Note** The voltage that the inverter can output is lower than the input voltage of the inverter. Appropriately set the voltage in accordance with the motor.

■ Non-linear V/f 1, 2, 3 (Frequency) (H50, H52, H65)

Set frequency at the arbitrary point of non-linear V/f pattern.

- Data setting range: 0.0 (Cancel), 0.1 to 500.00 (Hz)

 **Note** When 0.0 is set, the setting becomes the pattern without using non-linear V/f pattern. (limited to 120 Hz (max.) in ND mode)

■ Non-linear V/f 1, 2, 3 (Voltage) (H51, H53, H66)

Set voltage at the arbitrary point of non-linear V/f pattern.

- Data setting range: 0 to 240 (V) : AVR operation (at 200 V class)
0 to 500 (V) : AVR operation (at 400 V class)

■ Maximum output voltage 1 (F06)

Set the voltage at maximum output frequency 1 (F03).

- Data setting range: 80 to 240 (V) : AVR operation (at 200 V class)
160 to 500 (V) : AVR operation (at 400V class)

 **Note** When rated voltage at base frequency (F05) is "0", the data of non-linear V/f (H50 to H53, H65, and H66) and F06 becomes invalid (linear V/f for at or below base frequency, and constant voltage for at or higher than base frequency).

F07, F08	Acceleration time1, Deceleration time 1 Related function codes: E10, E12, E14 Acceleration time 2, 3, 4 E11, E13, E15 Deceleration time 2, 3, 4 H07 Curve acceleration/deceleration H56 Deceleration time for forced stop H54, H55 Acceleration/deceleration time (Jogging) H57 to H60 Acceleration/deceleration range No. 1, No.2 S-curve range
----------	---

Acceleration time sets the time taken by the output frequency to reach the maximum output frequency from 0Hz, and deceleration time sets the time taken by the output frequency to reach 0Hz from the maximum frequency.

- Data setting range: 0.00 to 6000 (s)

For V/f control

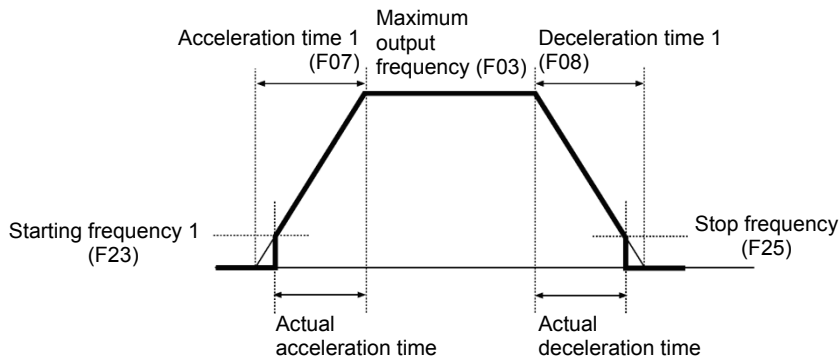

■ **Acceleration/Deceleration time**

Type of Acceleration/deceleration time	Function code		Select ACC/DEC time (☐ Function code E01 to E05)		
	Acceleration time	Deceleration time	"RT2"	"RT1"	
ACC/DEC time 1	F07	F08	OFF	OFF	Switch by acceleration/deceleration selection "RT1" "RT2". (Data = 4 or 5) When there is no assignment, acceleration/deceleration time 1 (F07, F08) are valid.
ACC/DEC time 2	E10	E11	OFF	ON	
ACC/DEC time 3	E12	E13	ON	OFF	
ACC/DEC time 4	E14	E15	ON	ON	
At jogging	H54	H55	When Ready for jogging "JOG" is ON, switch to the mode with which jogging operation is possible. (Data = 10) (☐ Function code C20)		
At Force to stop	-	H56	Turning the Force to stop "STOP" command OFF causes the motor to decelerate to a stop in accordance with the deceleration time for forced stop (H56). After the motor stops, the inverter enters the alarm state with the alarm $E-5$ displayed. (Data = 30)		

■ **Curve acceleration/deceleration (H07)**

Select acceleration/deceleration pattern (change pattern of frequency) at acceleration/deceleration

H07 data	Curve acceleration/ deceleration	Action		Function code
0	Disable (Linear acceleration/deceleration)	Acceleration/deceleration with constant acceleration.		-
1	S-curve acceleration/deceleration (Weak)	Smoothen the speed change and reduce shock when starting acceleration and right before the speed becomes constant, as well as when starting deceleration and right before the deceleration stops.	Weak: Fix acceleration/deceleration change rate to 5% of the maximum output frequency within each S-curve range.	-
2	S-curve acceleration/deceleration (Arbitrary)		Arbitrary: It is possible to set acceleration/deceleration change rate arbitrarily within each S-curve range.	H57, H58 H59, H60
3	Curve acceleration/deceleration	Linear acceleration/deceleration (constant torque) at or below base frequency and acceleration becomes gradually slower at or higher than the base frequency, and acceleration/deceleration with constant load rate (rated output). It is possible to accelerate/decelerate with the maximum capability.		-

S-curve acceleration/deceleration

For the purpose of decreasing the shock on the load machine side, smoothen the speed change at the start of acceleration and right before it becomes constant speed, and at the start of deceleration and right before the stop of deceleration. As for s-curve acceleration/deceleration values, fix with 5% for S-curve acceleration/deceleration (weak), and for S-curve acceleration/deceleration (arbitrary), it is possible to set individually for each 4 locations by function codes H57 to 60. The specified acceleration/deceleration time determines acceleration of linear part and the actual acceleration/deceleration time becomes longer than the specified acceleration /deceleration time.

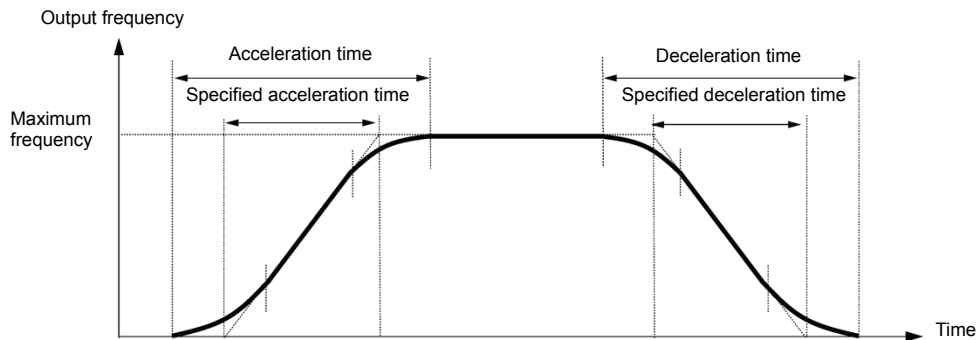

	At the start of acceleration	At the end of acceleration	At the start of deceleration	At the end of deceleration
S-curve (Weak)	5%	5%	5%	5%
S-curve (Arbitrary) Setting range: 0 to 100%	H57 At acceleration No. 1 S-curve range (At starting)	H58 At acceleration No. 2 S-curve range (At arrival)	H59 At deceleration No. 1 S-curve range (At starting)	H60 At acceleration No. 2 S-curve range (At the arrival)

Acceleration/Deceleration time

< S-curve acceleration/deceleration (Weak): When frequency change is 10% or higher than the maximum frequency >

$$\begin{aligned} \text{Acceleration or deceleration time (s)} &= (2 \times 5/100 + 90/100 + 2 \times 5/100) \times \text{reference acceleration or deceleration time} \\ &= 1.1 \times \text{reference acceleration or deceleration time} \end{aligned}$$

< S-curve acceleration/deceleration (Arbitrary: When 10% at the start, 20% at the end): When frequency change is 30% or higher than the maximum frequency >

$$\begin{aligned} \text{Acceleration or deceleration time (s)} &= (2 \times 10/100 + 70/100 + 2 \times 20/100) \times (\text{reference acceleration or deceleration time}) \\ &= 1.3 \times (\text{reference acceleration or deceleration time}) \end{aligned}$$

Curve acceleration/deceleration

This is a pattern to perform linear acceleration/deceleration (rated torque) at or below base frequency and acceleration becomes gradually slower at or higher than the base frequency, and acceleration/deceleration with constant load rate (rated output).

It is possible to accelerate/decelerate with the maximum capability of the motor to be driven by the inverter.

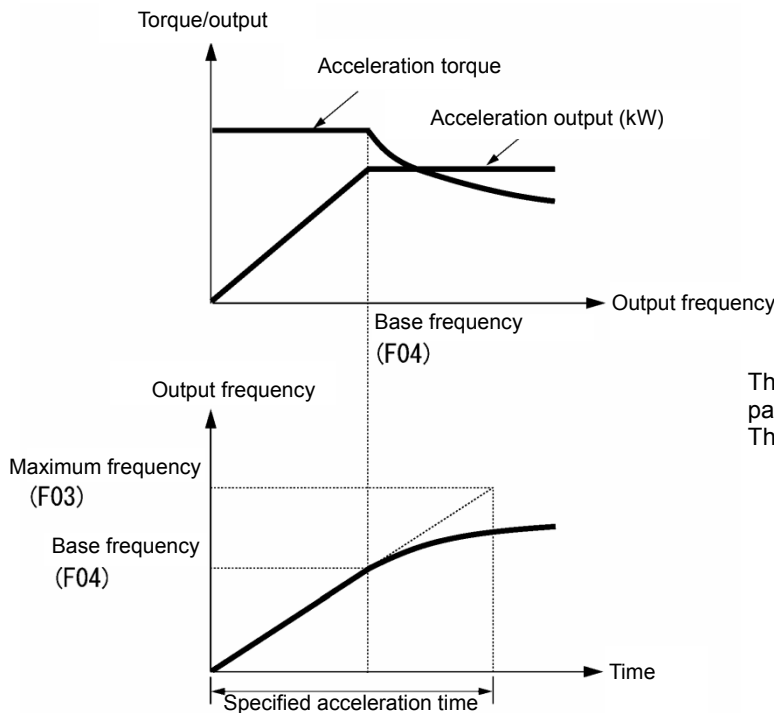

The diagram on the left shows pattern at acceleration. This is the same as at deceleration.

- Note**
- When S-curve acceleration/deceleration and curve acceleration/deceleration is selected by curve acceleration/deceleration H07, the actual acceleration/deceleration time becomes longer than the set value.
 - If acceleration/deceleration time is set shorter than necessary, current limiting function, torque limit or anti-regenerative function may operate and acceleration/deceleration time may become longer than the set value.

F09	Torque boost 1	(Refer to F37)
------------	-----------------------	-----------------------

For details of torque boost 1 setting, refer to the section of function code F37.

F10 to F12	Electronic thermal overload Protection for motor 1 (Select motor characteristics, Thermal time constant)
-------------------	---

In order to detect overload of motor (electronic thermal function by inverter output current), set temperature characteristics of motor (Select motor characteristics (F10), thermal time constant (F12), and overload detection level (F11).

When overload of motor is detected, inverter is turned off, protecting the motor with motor overload alarm \overline{OL} !.

- Note** Improper setting of the electronic thermal function may result in a failure to protect the motor from burning.
- Note** Temperature characteristics of motor is used for motor overload early warning “OL” as well. Even if only overload early warning is used, it is necessary to set temperature characteristics of the motor (F10, F12). (Function code E34)
For disabling motor overload alarm, set F11 = 0.00 (Disable).
- Note** For PTC thermistor built-in motor, by connecting PTC thermistor to terminal [C1], it is possible to protect the motor. Refer to H26 to find the details.

■ Select motor characteristics (F10)

F10 selects characteristics of cooling system of the motor.

F10 data	Function
1	Self-cooling fan of general-purpose motor (Self-cooling) (When operating with low frequency, cooling performance decreases.)
2	Inverter-driven motor, High-speed motor with separately powered cooling fan (Keep constant cooling capability irrespective to output frequency)

Figure 5.3-3 shows electronic thermal operation characteristics diagram when F10=1 is set. The characteristics coefficient $\alpha 1$ and $\alpha 3$ and the switch coefficient $f 2, f 3$ differ depending on the characteristics of the motor.

Each coefficient that is set by motor characteristics that is selected by motor capacitance and motor selection (P99) is shown in Table 5.3-2, Table 5.3-3 and Table 5.3-4.

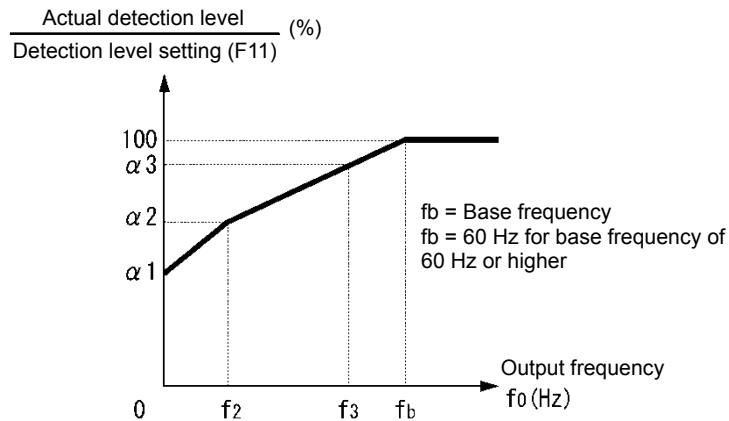

Figure 5.3-3 Characteristics diagram of motor cooling system

Table 5.3-2 When P99 = 0, 4 (Motor characteristics 0, Other)

Motor capacity	Thermal time constant τ (Factory default)	Thermal time constant setting Standard current value I_{max}	Characteristics coefficient switch frequency		Characteristics coefficient			
			$f 2$	$f 3$	$\alpha 1$	$\alpha 2$	$\alpha 3$	
0.4, 0.75 kW	5 min	Continuous allowance current value x 150%	5 Hz	7Hz	75%	85%	100%	
1.5 to 3.7 kW					85%	85%	100%	
5.5 to 11 kW					6Hz	90%	95%	100%
15 kW					7Hz	85%	85%	100%
18.5, 22 kW					5Hz	92%	100%	100%
30 to 45 kW	10 min		Base frequency x 33%	Base frequency x 83%	54%	85%	95%	
55 to 90 kW					51%	95%	95%	
110 kW or above					53%	85%	90%	

Table 5.3-3 When P99 = 1 (Motor characteristics 1)

Motor capacity	Thermal time constant τ (Factory default)	Thermal time constant setting Standard current value I_{max}	Characteristics coefficient switch frequency		Characteristics coefficient				
			$f 2$	$f 3$	$\alpha 1$	$\alpha 2$	$\alpha 3$		
0.2 to 22 kW	5 min	Continuous allowance current value x 150%	Base frequency x 33%	Base frequency x 33%	69%	90%	90%		
30 to 45 kW	10 min				Base frequency x 33%	Base frequency x 83%	54%	85%	95%
55 to 90 kW							51%	95%	95%
110 kW or above							53%	85%	90%

Table 5.3-4 When P99 = 20,21 (Motor characteristics)

Motor capacity	Thermal time constant τ (Factory default)	Thermal time constant setting Standard current value I_{max}	Characteristics coefficient switch frequency		Characteristics coefficient		
			f_2	f_3	α_1	α_2	α_3
18.5kW to less than 110 kW	5 min	Continuous allowance current value x 150%	Base frequency x 33%	Base frequency x 83%	53%	85%	95%
110 kW or above	10 min				53%	85%	90%

When F10=2 is set, cooling effect by output frequency will not decrease, therefore, overload detection level becomes constant value (F11) without decrease.

■ **Overload detection level (F11)**

F11 sets operation level of electronic thermal.

- Data setting range: 1 to 135% of the rated current value of inverter (continuous allowance current value)

Normally, set to the motor continuous allowance current (in general, about 1.0 to 1.1 times of motor rated current) when operating at base frequency.

For disabling electronic thermal as disable, set F11 = 0.00: Disable.

■ **Thermal time constant (F12)**

F12 sets thermal time constant of the motor. For overload detection level that is set by F11, set the electronic thermal operation time when 150% of current is flowing continuously. Thermal time constant of general-purpose motor of Fuji Electric and general motors is 5 minutes for 22 kW or lower, and 10 minutes (factory default state) for 30kW or higher.

- Data setting range: 0.5 to 75.0 (min)

(Example) When the data of function code F12 is set to "5" (5 minutes).

As shown in Figure 5.3-4, when 150% of current of operation level that was set flows for 5 minutes, motor overload (alarm \overline{OL} / \overline{I}) protection function will operate. In addition, with 120%, it operates after 12.5 minutes.

The time when alarm actually occurs is shorter than the set data because the time until the current reaches 150% level after exceeding the continuous allowance current (100%) is considered.

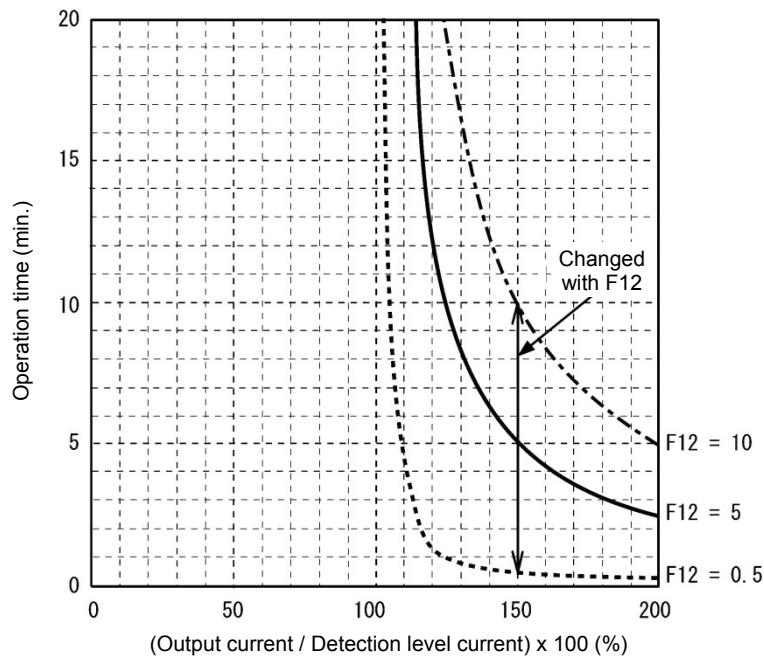

Figure 5.3-4 Example of current-operation time characteristics

F14	Restart mode after momentary power failure (Mode selection) Related function codes: H13 (Restart timer) H14 (frequency lowering rate) H15 (Continuous running level) H16 (Allowable momentary power failure time) H92 Continuous running at the momentary power failure (P) H93 Continuous running at the momentary power failure (I)
------------	--

Set the operation for when momentary power failure occurs (trip operation, restart operation method at auto-restarting)

■ **Restart mode after momentary power failure (Mode selection) (F14)**

V/f control (F42=0,2,3), dynamic torque vector control(F42=1,4), PM motor control(F42=15)

F14 data	Operation contents	
	Without auto search	With auto search
0: Trip immediately	When momentary power failure occurs while operating the inverter, and at the time when undervoltage is detected by the DC link bus voltage of the inverter, undervoltage alarm lu is outputted, the inverter output shuts down, and the motor coasts to a stop.	
1: Trip after a recovery from power failure	When momentary power failure occurs while operating the inverter, and at the time when undervoltage is detected by the DC link bus voltage of the inverter, the inverter output shuts down and the motor coasts to stop, but the undervoltage alarm will not be outputted. When auto-started from momentary power failure, undervoltage alarm lu is outputted.	
2: Trip after momentary deceleration is stopped	As soon as the DC link bus voltage drops below the continuous running level due to a momentary power failure, decelerate-to-stop control is invoked. Decelerate-to-stop control regenerates kinetic energy from the load's moment of inertia, slowing down the motor and continuing the deceleration operation. After decelerate-to-stop operation, an undervoltage alarm lu is issued.	
3: Continue to run (for heavy inertia load or general load)	As soon as the DC link bus voltage drops below the continuous running level due to a momentary power failure, decelerate-to-stop control is invoked. Decelerate-to-stop control regenerates kinetic energy from the load's moment of inertia, slowing down the motor, and operation is continued to wait for auto-restarting. If there is not enough energy for regeneration and when undervoltage is detected, the inverter output shuts down and the motor coasts to a stop.	
	If run command is entered at auto-restarting, restart from the frequency of when undervoltage is detected.	If run command is entered at auto-restarting, auto-searching is performed, motor speed is estimated, and restart from the frequency.
	This setting is most suitable for the fan with large inertia moment of load.	
4: Restart from frequency at power failure (for general load)	When momentary power failure occurs while operating the inverter, and at the time when undervoltage is detected by the DC link bus voltage of the inverter, the inverter output shuts down, and the motor coasts to a stop.	
	If run command is entered at auto-restarting, restart from the frequency of when undervoltage is detected.	If run command is entered at auto-restarting, auto-searching is performed, motor speed is estimated, and restart from the frequency.
	This setting is most suitable for the case (fan) when load inertial moment is large, and motor speed does not decrease so much even if the motor coasts to a stop due to momentary power failure.	
5: Restart from starting frequency	When momentary power failure occurs while operating the inverter, and at the time when undervoltage is detected by the DC link bus voltage of the inverter, the inverter output shuts down, and the motor coasts to a stop.	
	If run command is entered at auto-restarting, restart from the starting frequency that was set by function code F23.	If run command is entered at auto-restarting, auto-searching is performed, motor speed is estimated, and restart from the frequency.
	This setting is most suitable for the case (pump etc.) when load inertia moment is small, when the load is heavy, and motor speed decreases up to 0 in a short time after the motor coasts to a stop due to momentary power failure.	

With auto-searching: Auto-searching is selected by starting mode selection "STM" ON or H09/d67 = 1 or 2.
Refer function code H09/d67 (Starting mode) to find the detail of starting mode selection "STM" ON auto-searching.

⚠ WARNING

When momentary power failure restart operation (F14 = 3 to 5) is selected, operation will resume automatically at auto-restarting. Design your machinery so that safety is ensured even at restarting.

Otherwise an accident could occur.

Under vector control with speed sensor (F42=6)

Data for F14	Description
0: Trip immediately	As soon as the DC link bus voltage drops below the undervoltage detection level due to a momentary power failure, the inverter issues undervoltage alarm $\underline{\underline{U}}$ and shuts down its output so that the motor enters a coast-to-stop state.
1: Trip after a recovery from power failure	As soon as the DC link bus voltage drops below the undervoltage detection level due to a momentary power failure, the inverter shuts down its output so that the motor enters a coast-to-stop state, but it does not enter the undervoltage state or issue undervoltage alarm $\underline{\underline{U}}$. The moment the power is restored, an undervoltage alarm $\underline{\underline{U}}$ is issued, while the motor remains in a coast-to-stop state.
2: Trip after momentary deceleration is stopped	As soon as the DC link bus voltage drops below the continuous running level due to a momentary power failure, decelerate-to-stop control is invoked. Decelerate-to-stop control regenerates kinetic energy from the load's moment of inertia, slowing down the motor and continuing the deceleration operation. After decelerate-to-stop operation, an undervoltage alarm $\underline{\underline{U}}$ is issued.
3: Continue to run	If the F14 data is set to "3," then the "Continue to run" function is enabled.
4: Restart from frequency at power failure 5: Restart from starting frequency	As soon as the DC link bus voltage drops below the undervoltage detection level due to a momentary power failure, the inverter shuts down the output so that the motor enters a coast-to-stop state. Even if the F14 data is set to "3," the "Continue to run" function is disabled. If a run command has been input, restoring power restarts the inverter at the motor speed detected by the speed sensor.

■ Restart mode after momentary power failure (Basic operation: Without auto-searching setting)

When inverter detected that DC link bus voltage becomes at or drops below undervoltage level while operating, it is judged as a momentary power failure. When load is light and momentary power failure is very short, momentary power failure may not be detected and motor operation might be continued because DC link bus voltage does not drop so much.

When inverter judges the state as momentary power failure, returns to momentary power failure restart mode and prepares for restart. After power is auto-restarted, the inverter becomes at inverter ready to run state after elapse of initial charging time. At momentary power failure, power of external circuit (relay circuit etc.), which controls the inverter, decreases as well, and run command may be turned off. Therefore, when the inverter becomes at inverter ready to run state, wait 2 seconds for input of run command. When input of run command is confirmed within 2 seconds, initiate restarting according to F14 (mode selection). When there is no input of run command at run command input waiting state, momentary power failure restart mode will be released and start from normal starting frequency. Therefore, input run command within 2 seconds after auto-restarting or hold run command by off-delay timer or mechanical latch relay.

In case of F02=0 (run command from keypad and rotation direction command determined by terminal), it operates in the same way as above. For rotation direction fixed mode (F02 = 2, 3), run command is held within the inverter, therefore, it restarts immediately at inverter ready to run state.

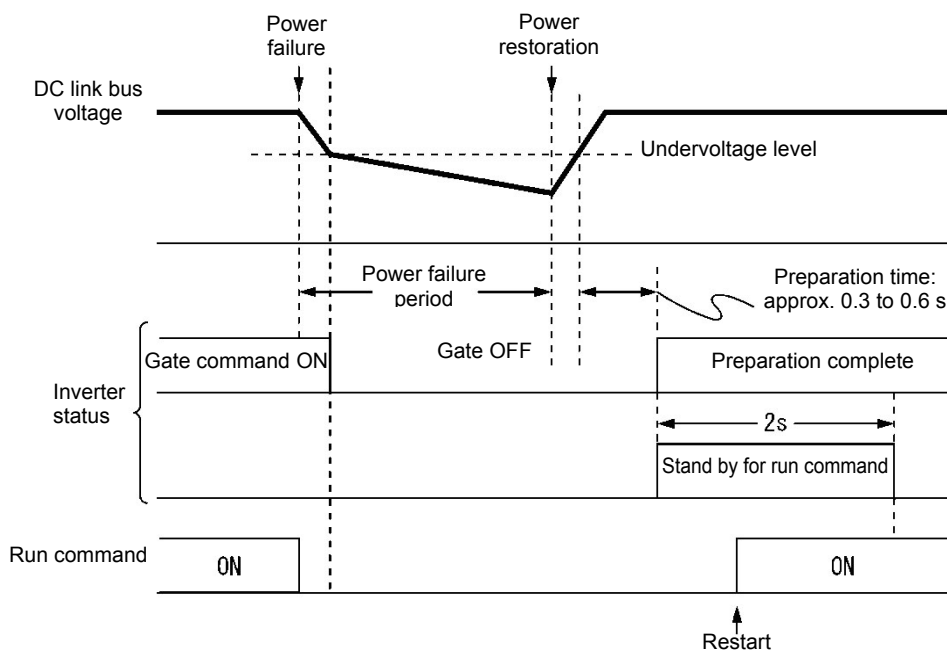

Note

- At auto-restarting, inverters waits 2 seconds for input of run command, however, if allowable momentary power failure time (H16) is elapsed after the state is judged as power failure, the state of run command input waiting for 2 seconds will be canceled and normal starting operation is performed.
- When coast to a stop command "BX" is entered during power failure, momentary power failure restart waiting state is released and return to normal run mode, and when run command is inputted, start from normal starting frequency.
- Detection of momentary power failure within the inverter is performed by detecting DC link bus voltage drop of the inverter. With the structure in which a magnetic contactor is equipped on the output side of the inverter, there will be no operation power of the magnetic contactor at momentary power failure and the magnetic contactor becomes at open state. When the magnetic contactor becomes open, connection of inverter and motor is released and load of the inverter is shutdown. Therefore, it becomes difficult to decrease DC link bus voltage of the inverter and it may not be judged as a momentary power failure. If this is the case, momentary power failure restart will not be performed normal. As a countermeasure against this case, by connecting auxiliary contact signal of the magnetic contactor to the interlock signal "IL" it is possible to detect momentary power failure without fail.

Function code E01 to E05 Data = 22

Terminal command "IL"	Meaning
OFF	No momentary power failure has occurred.
ON	A momentary power failure has occurred. (Restart after a momentary power failure enabled)

When motor speed decreases during momentary power failure, and when restarting from frequency of before momentary power failure after power is recovered (auto-restarting), current limiter becomes active and output frequency of the inverter decreases automatically. When output frequency and motor rotation speed synchronize, the speed is accelerated up to the original output frequency. Refer to the figure below. However, it is necessary to enable instantaneous overcurrent limiting (H12 = 1) to bring in synchronization of the motor.

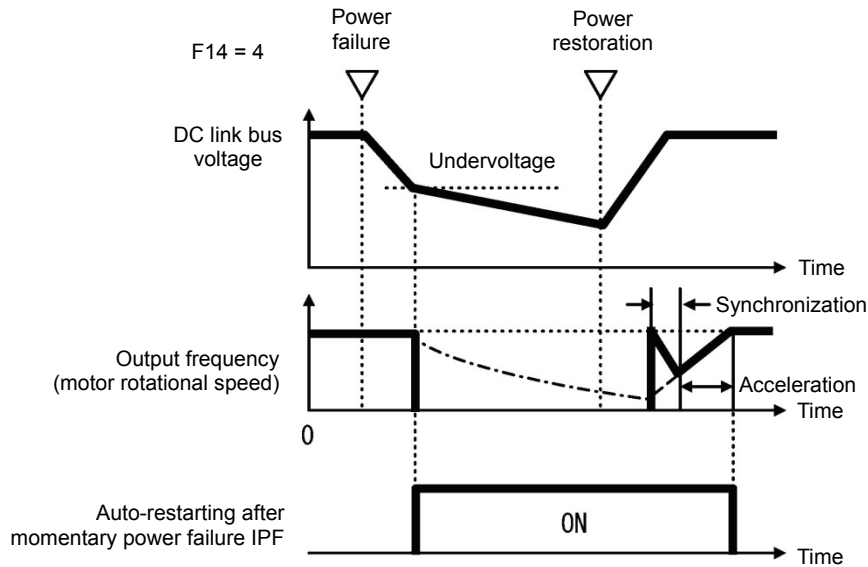

- Auto-restarting after momentary power failure “IPF”

During momentary power failure auto-restarting “IPF” signal is turned on until returning to original frequency after auto-restarting after momentary power failure occurred. When “IPF” is turned ON, motor speed decreases, therefore, take necessary measures. (📖 Function code E20, E21, E27 Data = 6)

■ Restart mode after momentary power failure (Basic operation: With auto-searching setting)

Auto-searching is not performed normally if there is residual voltage of the motor. Therefore, it is necessary to secure the time until residual voltage runs out.

Restart mode after momentary power failure secures the necessary time with function code H46 starting mode (auto search delay time 2). Even if starting conditions are satisfied, inverter does not start unless auto-search delay time elapses after inverter goes into OFF state. Inverter starts after elapse of auto-searching delay time. (📖 Function code H09, d67)

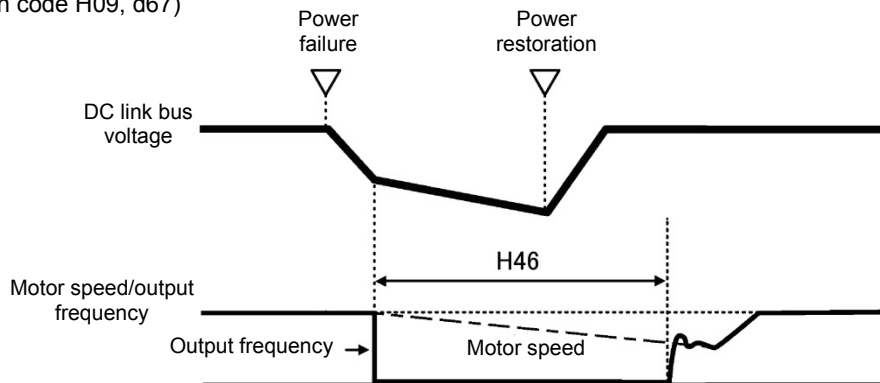

- When operating auto-searching, it is necessary to perform auto-tuning in advance.
- When the estimated speed exceeds the maximum frequency or the upper limit frequency, the inverter disables auto search and starts running the motor with the maximum frequency or the upper limit frequency, whichever is lower.
- During auto search, if an overcurrent or overvoltage trip occurs, the inverter will restart the auto search.
- Use 60 Hz or below for auto-searching
- Note that auto search may not fully provide the performance depending on load conditions, motor parameters, wiring length, and other external factors.
- When output circuit filter OFL-□□□-2, -4 is equipped on the output side of the inverter, auto-searching must be disabled. Use OFL-□□□-□A type.

■ Restart mode after momentary power failure (Allowable momentary power failure time) (H16)

Sets the maximum time from when momentary power failure (undervoltage level) occurs until restart (setting range: 0.0 to 30.0 s). Set coast to a stop time which is allowable for machine and equipment. Momentary power failure restart operation should be performed within the specified time, however, if the set time is exceeded, the inverter judges the state as a power shut down, and then operates as powering on again without performing momentary power failure restart operation.

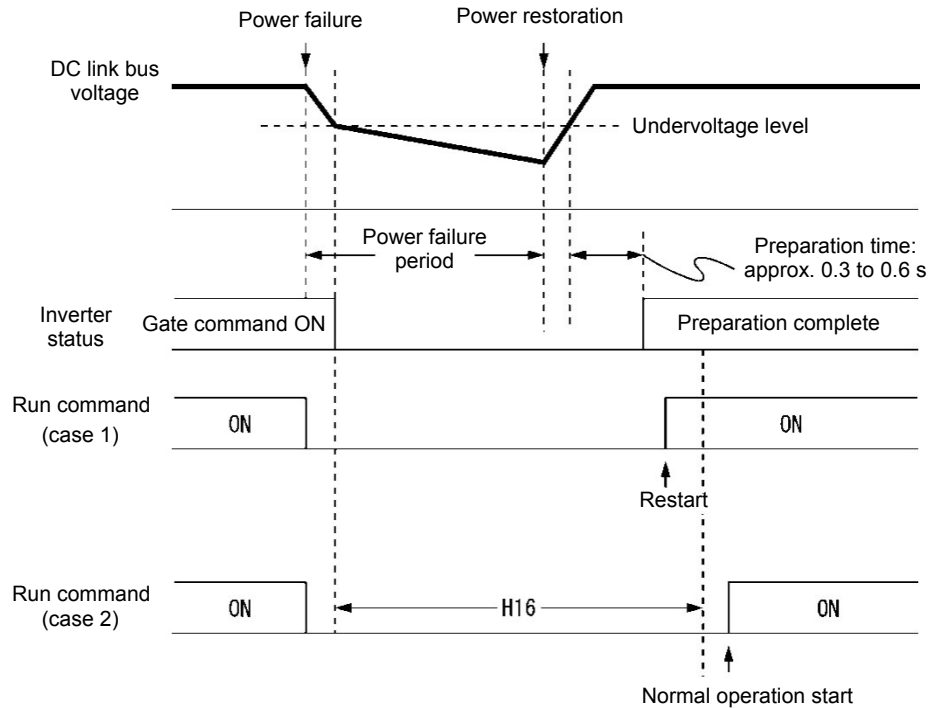

When allowable momentary power failure time (H16) is set to “999”, momentary power failure restart is performed until DC link bus voltage decreases by momentary power failure restart allowance voltage (50 V for 200 V class, 100 V for 400 V class), however, if the voltage becomes at or below the momentary power failure allowance voltage, the state is judged as a power shut down. As a result, the inverter operates as powering ON again without performing momentary power failure restart operating.

Power supply voltage	Allowance voltage of momentary power failure restart
200V	50V
400V	100V



The time until voltage decreases to the momentary power failure restart allowance voltage from undervoltage differs greatly depending on the inverter capacity and with/without option.

■ **Restart mode after momentary power failure (Restart timer) (H13) (Exclusive to V/f control for IM)**

H13 set the time until restart is performed after momentary power failure occurred. (At auto-searching setting, use H46 (auto search holding time 2)).

Restarting at the state when residual voltage of the motor is high, inrush current becomes greater or temporarily becomes at regeneration state, and overcurrent alarm may occur. For security reason, in order to restart after residual voltage is reduced to some extent, adjust H13. Even if auto-restarted, restart cannot be performed until the holding time (H13) elapses.

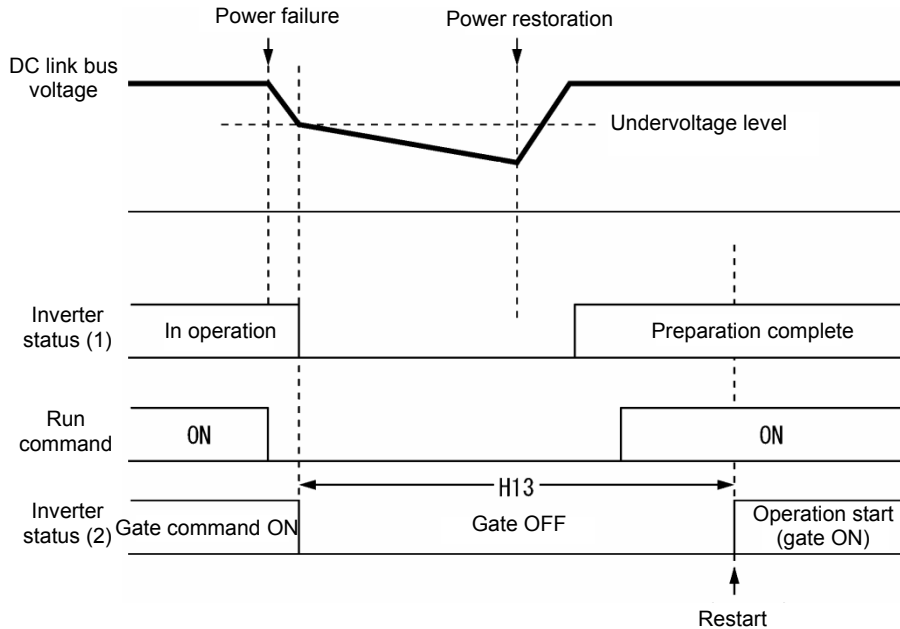

Factory default: At the factory default state, setting is performed so that it is appropriate to the standard motor (refer to “5.2.3 Factory default value per applicable electric motor capacitance”). Basically, there is no need to modify the default setting. However, when problems occur due to the long holding time or decrease in flow rate of pump becomes significant, change to about half of the standard value and make sure that alarm etc. will not occur.

■ **Restart Mode after Momentary Power Failure (H14)(Exclusive to V/f control for IM)**

At momentary power failure restart operation, when inverter output frequency and motor rotation speed does not synchronize, overcurrent occurs and current limiter will operate. when current limit is detected, automatically decrease the output frequency and synchronize with the motor rotation speed. H14 sets the slope of lowering output frequency (frequency lowering rate in Hz/s).

H14 data	Output frequency lowering operation
0.00	Decrease by the selected deceleration time.
0.01 to 100.00 (Hz/s)	Decrease by the lowering rate that is set by H14.
999	Depending on the PI regulator of current limiting processing (PI constant is fixed value within the inverter), the rate will decrease.



When frequency lowering rate is increased, regeneration operation is performed at the moment when output frequency of the inverter and rotation speed of inverter synchronize, and overvoltage trip may occur. When frequency lowering rate is reduced, the time until output frequency of the inverter and motor rotation speed synchronize (current limiting operation) becomes longer, and protection operation of inverter overload may be activated.

■ **Restart mode after momentary power failure (Continuous running level) (H15)
Continued operation at the momentary power failure (P, I) (H92, H93)**

- Trip after momentary deceleration is stopped

When trip after deceleration stopped is selected (F14 = 2), at momentary power failure restart operation (Mode selection), momentary power failure occurs while operating the inverter, and deceleration stop control starts when DC link bus voltage of the inverter becomes at or drops below the continuous running level.

Adjust voltage level of DC link bus to start deceleration stop control by H15.

Under decelerate-to-stop control, the inverter decelerates its output frequency keeping the DC link bus voltage constant using a PI regulator.

P (proportional) and I (integral) components of the PI regulator are specified by H92 and H93, respectively.

For normal inverter operation, it is not necessary to modify data of H15, H92 or H93.

- Continue to run

When momentary power failure restart operation (Continue to run) is selected (F14 = 3) at momentary power failure restart (operation selection), momentary power failure occurs while operating the inverter and continue to run control starts when DC link bus voltage of the inverter becomes at or drops below the continue to run level.

Adjust continue to run level to start continue to run control by H15.

Under the continue to run control, the inverter continues to run keeping the DC link bus voltage constant using the PI regulator.

P (proportional) and I (integral) components of the PI regulator are specified by H92 and H93, respectively.

For normal inverter operation, it is not necessary to modify data of H15, H92 or H93.

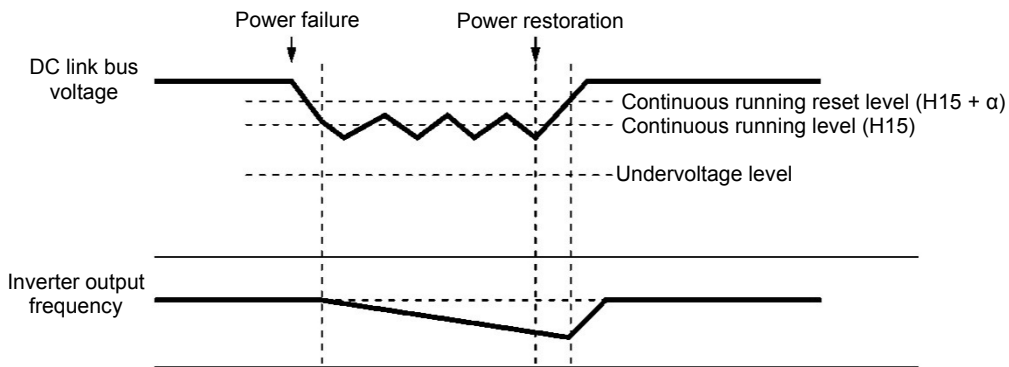

Power supply group	Alpha (α)	
	22 kW or below	30 kW or above
200 V	5 V	10 V
400 V	10 V	20 V



Even if “Deceleration stop control” or “Continue to run”, is selected, the inverter may not be able to perform the function when the inertia of the load is small or the load is heavy, due to undervoltage caused by the control delay. In such a case, when “Deceleration stop control” is selected, the inverter allows the motor to coast to a stop; when “Continue to run” is selected, the inverter saves the output frequency being applied when the undervoltage alarm occurs and perform momentary power failure restart operation.

When the input power voltage for the inverter is high, setting the continue to run level high makes the control more stable even if the inertia of the load is relatively small. Raising the continuous running level too high, however, might cause the continue to run control activated even during normal operation.

When the input power voltage for the inverter is extremely low, continue to run control might be activated even during normal operation, at the beginning of acceleration or at an abrupt change in load. To avoid this, lower the continuous running level. Lowering it too low, however, might cause undervoltage that results from voltage drop due to the control delay.

Before you change the continuous running level, make sure that the continuous running control will be performed properly, by considering the fluctuations of the load and the input voltage.

F15, F16	Frequency limiter (Upper limit), Frequency limiter (Lower limit) Related function codes: H63 Lower limit Limiter (Mode selection)
-----------------	--

■ **Frequency limiter (Upper limit) (Lower limit) (F15, F16)**

F15 and F16 specify the upper and lower limits of the output frequency or reference frequency, respectively.

Frequency Limiter		Object to which the limit is applied
Frequency limiter (Upper)	F15	Output frequency
Frequency limiter (Lower)	F16	Reference frequency
 Note When the limit is applied to the reference frequency or reference speed, delayed responses of control may cause an overshoot or undershoot, and the frequency may temporarily go beyond the limit level.		

- Data setting range: 0.0 to 500.0 (Hz)

■ **Low Limiter (Mode selection) (H63)**

H63 specifies the operation to be carried out when the reference frequency drops below the low level specified by F16, as follows:

H63 data	Action
0	The output frequency will be held at the low level specified by F16.
1	The inverter decelerates to stop the motor.

Refer to the figure below.

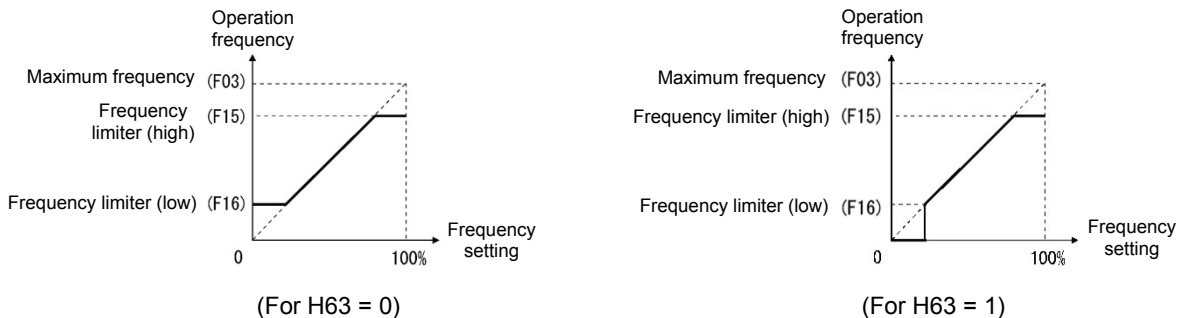

-  **Note**
- When changing the frequency limiter (Upper) (F15) in order to raise the reference frequency, be sure to change the maximum frequency (F03) accordingly.
 - Set each function code related to operation frequency so that the relationship among data becomes the following magnitude relationship.
 - F15>F16, F15>F23, F15>F25
 - F03>F16

However, F23 is the starting frequency, and F25 is stop frequency

If any wrong data is specified for these function codes, the inverter may not run the motor at the desired speed, or cannot start it normally.

F18	Bias (for frequency setting 1)	(Refer to F01)
------------	---------------------------------------	-----------------------

Refer to the description of function code F01 to find the details of bias (Frequency setting 1) setting.

F20 to F22 H95 H195	DC braking1 (Starting frequency, braking level, braking time) DC braking (Braking response mode) DC braking (Braking timer at the startup)
---------------------------	--

These function codes specify the DC braking that prevents motor 1 from running by inertia during decelerate-to-stop operation.

If the motor enters a decelerate-to-stop operation by turning OFF the run command or by decreasing the reference frequency below the stop frequency, the DC braking starts when output frequency reached the DC braking starting frequency. Set braking starting frequency (F20), braking level (F21), and braking time (F22) to start DC braking when deceleration is stopped.

Setting the braking time to "0.00" (F22 = 0) disables the DC braking.

By H195, it is possible to perform DC braking when starting up inverter. By doing so, it is efficient for preventing from falling down when the brake is released, and prompt torque startup when starting up.

■ Braking starting frequency (F20)

F20 specifies the frequency at which the DC braking starts its operation during motor decelerate-to-stop state.

- Data setting range: 0.0 to 60.0 (Hz)

■ Braking level (F21)

F21 specifies the output current level to be applied when the DC braking is activated. The function code data should be set, assuming the rated output current of the inverter as 100%, in increments of 1%.

- ND:0 to 60(%), HD/HND:0 to 80%,HHD:0 to 100%



The inverter rated output current differs between the ND/HD/HND/HHD modes.

■ Braking time (F22)

F22 specifies the braking period that activates DC braking.

- Data setting range: 0.00 (Disable), 0.01 to 30.00 (s)

■ **Braking response mode (H95)**

H95 specifies the DC braking response mode.

H95 data	Characteristics	Note
0	Slow response. Slows the rising edge of the current, thereby preventing reverse rotation at the start of DC braking.	Insufficient braking torque may result at the start of DC braking.
1	Quick response. Quickens the rising edge of the current, thereby accelerating the build-up of the braking torque.	Reverse rotation may result depending on the moment of inertia of the mechanical load and the coupling mechanism.

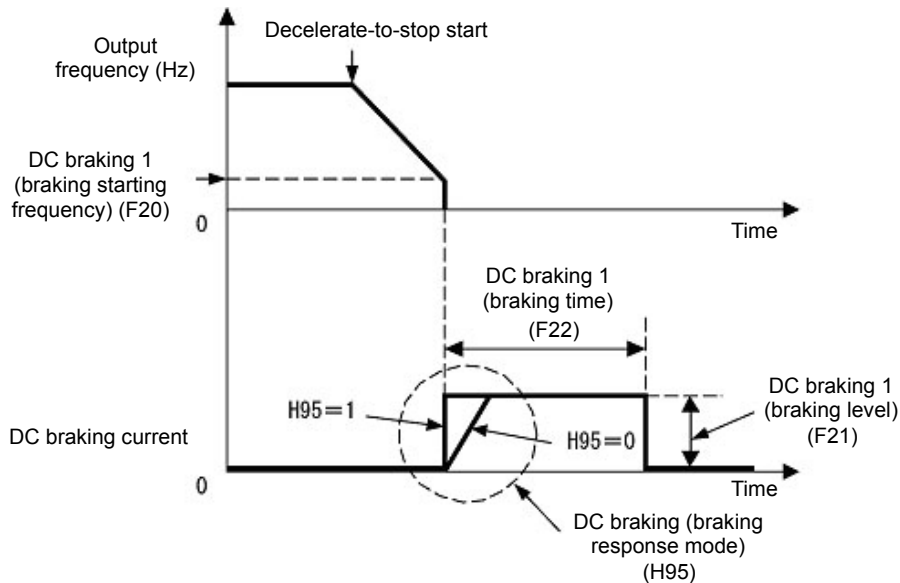

It is also possible to input DC braking command “DCBRK” by using an external digital input signal as the terminal command. As long as the DCBRK is ON, the inverter performs DC braking, regardless of the braking time specified by F22.

(Refer to function code E01 to E05 Data =13 to find the details of “DCBRK”)

Turning the “DCBRK” ON even when the inverter is in a stopped state activates the DC braking. This feature allows the motor to be excited before starting, resulting in smoother acceleration (quicker build-up of acceleration torque) (under V/f control).

Depending on the timing of the activation of “DCBRK”, alarm of overvoltage or overcurrent occurs.



In general, specify data of function code F20 at a value close to the rated slip frequency of motor. If an extremely high value is set, control may become unstable and an overvoltage alarm may result in some cases.

⚠ CAUTION

The DC braking function of the inverter does not provide any holding mechanism.

Injuries could occur.

■ Braking timer at the startup (H195)

When starting up inverter by run command, it is possible to start by operating DC braking.

This is particularly useful in applications such as hoists and elevators where the inverter runs at low speed braking mode after starting up, preventing loads from falling.

- Data setting range: 0.00: No DC braking at the start up 0.01 to 30.00 (s)

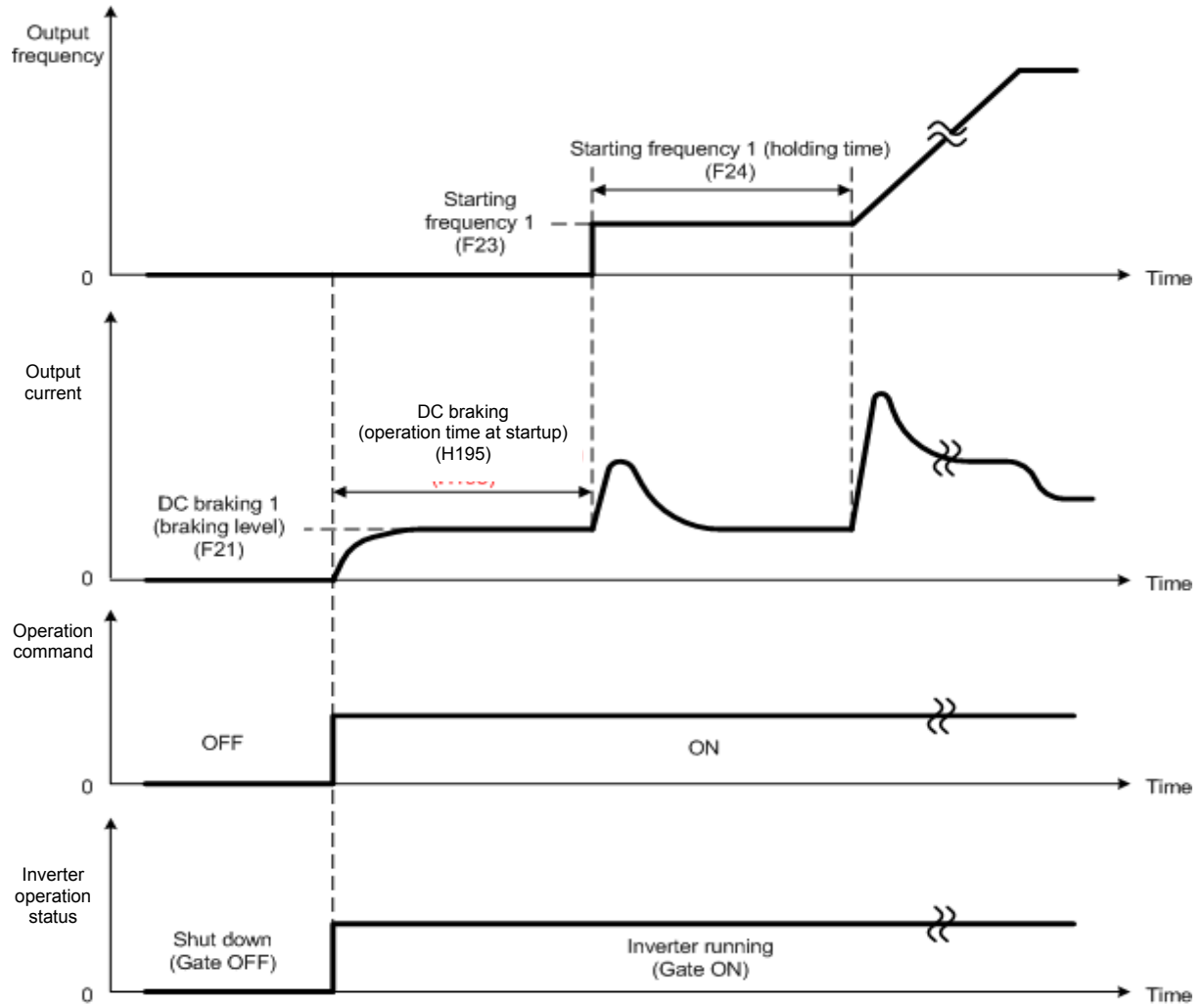

F23 to F25	Starting frequency 1, Starting frequency 1 (Holding time) and Stop frequency Related function codes: F38 and F39 (Stop frequency, Detection mode and Holding time) d24 (Zero speed control)
------------	--

Under V/f control

At the startup of an inverter, the initial output frequency is equal to the starting frequency. The inverter stops its output when the output frequency reaches the stop frequency. Set the starting frequency to a level at which the motor can generate enough torque for startup. Generally, set the rated slip frequency of the motor as the starting frequency.

Specifying the holding time for the starting frequency compensates for the delay time for the establishment of a magnetic flux in the motor; specifying that for the stop frequency stabilizes the motor speed at the stop of the inverter.

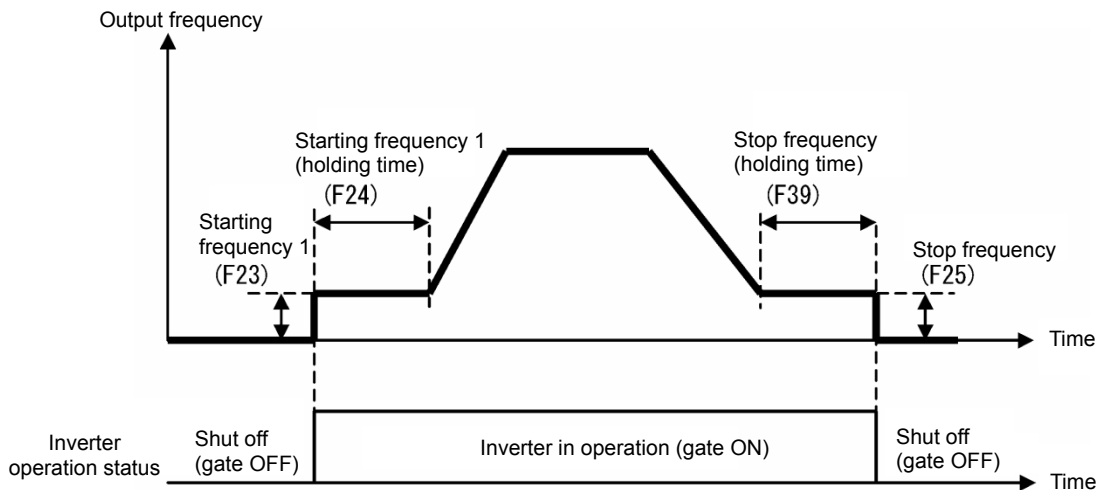

■ Starting frequency 1 (F23)

F23 specifies the starting frequency at the startup of an inverter.

- Data setting range: 0.0 to 60.0 (Hz)
Under V/f control, even if the start frequency is set at 0.0 Hz, the inverter starts its output at 0.1 Hz.

■ Starting frequency 1 (Holding time) (F24)

F24 specifies the holding time for the starting frequency 1.

- Data setting range: 0.00 to 10.00 (s)

■ Stop frequency (F25)

F25 specifies the stop frequency at the stop of the inverter.

- Data setting range: 0.0 to 60.0 (Hz)
Under V/f control, even if the stop frequency is set at 0.0 Hz, the inverter stops its output at 0.1 Hz.

■ Stop frequency (Holding time) (F39)

F39 specifies the holding time for the stop frequency.

- Data setting range: 0.00 to 10.00 (s)



If the starting frequency is lower than the stop frequency, the inverter does not output any power as long as the reference frequency does not exceed the stop frequency.

Under vector control with speed sensor

At the startup, the inverter first starts at the “0” speed and accelerates to the starting frequency according to the specified acceleration time. After holding the starting frequency for the specified period, the inverter again accelerates to the reference speed according to the specified acceleration time.

The inverter stops its output when the reference speed or actual speed (specified by F38 under vector control with speed sensor only) reaches the stop frequency specified by F25.

Specifying the holding time for the starting frequency compensates for the delay time for the establishment of a magnetic flux in the motor; specifying that for the stop frequency stabilizes the motor speed at the stop of the inverter.

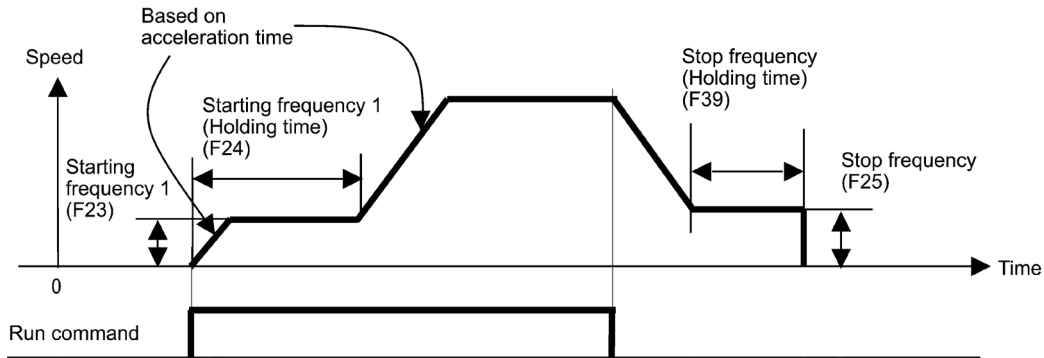

■ Starting frequency 1 (F23)

F23 specifies the starting frequency at the startup of an inverter.

- Data setting range: 0.0 to 60.0 (Hz)

■ Starting frequency 1 (Holding time) (F24)

F24 specifies the holding time for the starting frequency 1.

- Data setting range: 0.00 to 10.00 (s)

■ Stop frequency (F25)

F25 specifies the stop frequency at the stop of the inverter.

- Data setting range: 0.0 to 60.0 (Hz)

■ Stop frequency (Holding time) (F39)

F39 specifies the holding time for the stop frequency.

- Data setting range: 0.00 to 10.00 (Hz)

■ Zero speed control (d24) (Under vector control with speed sensor only)

To enable zero speed control under vector control with speed sensor, it is necessary to set the speed command (frequency command) below the starting and stop frequencies. If the starting and stop frequencies are 0.0 Hz, however, zero speed control is enabled only when the speed command is 0.00 Hz. d24 specifies the operation for zero speed control at the startup of the inverter.

Data for d24	Zero speed control at startup	Descriptions
0	Not allowed	When it is smaller than the stop frequency and start frequency the speed command, zero speed control does not work even ON the operation command. Zero speed control to work once you have started once it is set to higher than the starting frequency the speed command.
1	Allowed	Setting the speed command at below the starting and stop frequencies and turning a run command ON enables zero speed control.

The table below shows the conditions for zero speed control to be enabled or disabled.

	Speed command	Run command	Data for d24	Operation
At startup	Below the starting and stop frequencies	OFF	—	Stop (Gate OFF)
		ON	0	Stop (Gate OFF)
				1
At stop	Below the stop frequency	ON	—	Zero speed control
		OFF	—	Stop (Gate OFF)

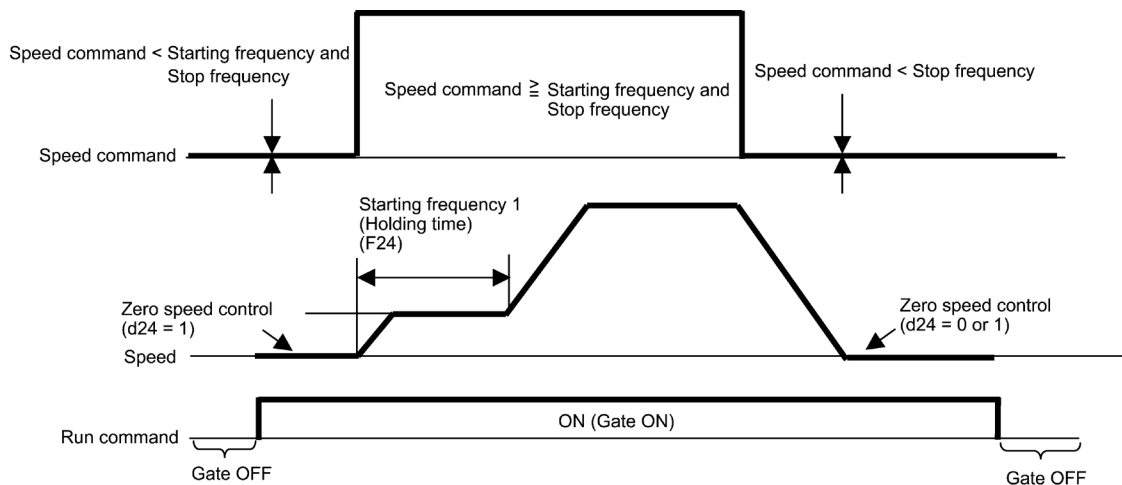

■ Stop Frequency (Detection mode) (F38) (Under vector control with speed sensor only)

F38 specifies whether to use the actual speed or reference one as a decision criterion to shut down the inverter output. Usually the inverter uses the detected speed. However, if the inverter undergoes a load exceeding its capability, e.g., an excessive load, it cannot stop because the motor cannot stop so that the detected speed may not reach the stop frequency level. If such a situation could arise, select the reference speed that can reach the stop frequency level even if the detected speed does not, in order to stop the inverter without fail achieving a fail-safe operation.

- Data setting range: 0 (Detected speed)
1 (Reference speed)

F26, F27

Motor Sound (Carrier frequency, Tone)

Related function codes: H98 Protection/Maintenance function (Mode selection)

■ Motor Sound (Carrier frequency) (F26)

Adjust carrier frequency. By changing carrier frequency, it is possible to reduce an audible noise generated by the motor or electromagnetic noise from the inverter itself, and to decrease a leakage current from the main output (secondary) wiring.

Setting frequency of carrier frequency differs depending on each model overload rating (ND/HD/HND/HHD).

Item	Characteristics
Carrier frequency	Low to High
Motor sound noise emission	High ↔ Low
Motor temperature (due to harmonics components)	High ↔ Low
Ripples in output current waveform	Large ↔ Small
Leakage current	Low ↔ High
Electromagnetic noise emission	Low ↔ High
Inverter loss	Low ↔ High

Setting range of carrier frequency is as follows.

Modes	0.75 to 6kHz	0.75 to 10kHz	0.75 to 16kHz
FRN□□□□E2□-2□ (HHD)	—	—	0001 to 0115
FRN□□□□E2□-2□ (HND)	—	0115	0001 to 0088
FRN□□□□E2□-4□ (ND)	0072 or above	0002 to 0059	—
FRN□□□□E2□-4□ (HD/HND)	0203 or above	0072 to 0168	0002 to 0059
FRN□□□□E2□-4□ (HHD)	—	0203 or above	0002 to 0168
FRN□□□□E2□-7□ (HND/HHD)	—	—	0001 to 0012



Specifying a carrier frequency that is too low will cause the output current waveform to have a large amount of ripple. As a result, the motor loss increases, causing the motor temperature to rise. Furthermore, the large amount of ripple tends to cause a current limiting alarm. When the carrier frequency is set to 1 kHz or lower, therefore, reduce the load so that the inverter output current comes to be 80% or less of the rated current.

When a high carrier frequency is specified, the temperature of the inverter may rise due to the ambient temperature rise or an increase of the load. If it happens, the inverter automatically decreases the carrier frequency to prevent the inverter overload (\overline{LL}). With consideration for motor noise, the automatic reduction of carrier frequency can be disabled. Refer to the description of H98.

It is recommended to set the carrier frequency at 5 kHz or above under vector control with speed sensor. DO NOT set it at 1 kHz or below.

Running a PMSM at low carrier frequency may overheat the permanent magnet due to the output current harmonics, resulting in demagnetization. When decreasing the carrier frequency setting, therefore, be sure to check the allowable carrier frequency of the motor.

When using a Fuji standard PMSM with the rated load, decrease the carrier frequency. Setting a high carrier frequency decreases not only the harmonic components of the output current but also the allowed continuous running inverter output current.

■ Motor Sound (Tone) (F27)

F27 changes the motor running sound tone (only for motors under V/f control). This setting is effective when the carrier frequency specified by function code F26 is 7 kHz or lower. Changing the tone level may reduce the high and harsh running noise from the motor.

Note If the tone level is set too high, the output current may become unstable, or mechanical vibration and noise may increase. Also, this function code may not be very effective for certain types of motor.

F27 data	Function
0	Disable (Level 0)
1	Enable (Level 1)
2	Enable (Level 2)
3	Enable (Level 3)

F29 to F35

Terminal [FM], [FM2] (Mode selection, Output gain, Function selection, Pulse rate)

These function codes allow outputting monitor data such as output frequency and output current to terminals [FM], [FM2] as analog DC voltage, current, and pulse ([FM] only). In addition, voltage and current output level on terminals [FM], [FM2] is adjustable.

Note When switching voltage, current, and pulse, it is necessary to switch both mode selection function code and switch on the PCB.

Terminal [FM2] is mounted only on GB specification and C specification (for China).

There is no pulse output function for terminal [FM2]

Terminal	Mode selection function	Gain	Function	Pulse rate	Switch
[FM]	F29	F30	F31	F33	SW5
[FM2]	F32	F34	F35	None	SW7

■ Mode selection (F29, F32)

F29 and F32 select output form of terminals [FM], [FM2]. Accordingly, change the switches SW5, SW7 on the control PCB.

 For details of the switches on the control PCB, refer to Chapter 12 "SPECIFICATIONS."

F29 data	Terminal [FM] output form	Control PCB switch (SW5)
0	Voltage output (0 to +10 VDC)	FMV side
1	Current output (4 to 20 mA DC)	FMI side
2	Current output (0 to 20mA DC)	
3	Pulse output	FMP side

F32 data	Terminal [FM2] Output form	Control PCB switch (SW7)
0	Voltage output (0 to +10 VDC)	FMV side
1	Current output (4 to 20 mA DC)	FMI side
2	Current output (0 to 20mA DC)	

Note The output current is not isolated from analog input, and does not have an isolated power supply. Therefore, if an electrical potential relationship between the inverter and peripheral equipment has been established, e.g., by connecting an analog input, cascade connection of a current output device is not available.

Keep the optimum connection wire length.

■ Output gain (F30, F34)

F30, F34 allows you to adjust the output voltage within the range of 0 to 300%.

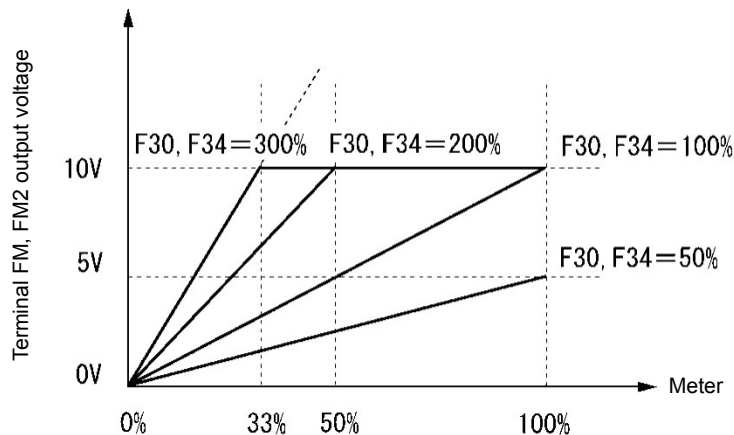

■ Function selection (F31, F35)

F31, F35 specify which data is monitored at the output terminals [FM], [FM2].

F31/F35 data	[FMA] output	Data	Definition of monitor amount 100%
0	Output frequency 1 (before slip compensation)	Output frequency of the inverter (Equivalent to the motor synchronous speed)	Maximum frequency (F03)
1	Output frequency 2 (after slip compensation)	Output frequency of the inverter	Maximum frequency (F03)
2	Output current	Output current (RMS) of the inverter	Twice the inverter rated current (Inverter rated output current depending on F80 setting)
3	Output voltage	Output voltage (RMS) of the inverter	200 V class: 250 V 400 V class: 500 V
4	Output torque	Motor shaft torque	Twice the rated motor torque
5	Load factor	Load factor (Equivalent to the indication of the load meter)	Twice the rated motor load
6	Input power	Input power of the inverter	Twice the rated output power (Inverter rated output power depending on F80)
7	PID feedback value	Feedback value under PID control	100% of the feedback amount
8	Actual speed/estimated speed	Speed detected through the PG interface, or estimated speed under vector control without speed sensor	Maximum speed as 100%
9	DC link bus voltage	DC link bus voltage of the inverter	200 V class: 500 V 400 V class: 1000 V
10	Universal AO	Command from communication (RS-485 communication user manual)	20,000/100%
13	Motor output	Motor output (kW)	Twice the rated motor output (P02/A16 setting value)
14	Calibration (+)	For meter calibration Full scale output	Always full scale (equivalent to 100%) Output
15	PID command (SV)	Command value under PID control	PID command 100%
16	PID output (MV)	Output level of the PID processor under PID control (Frequency command)	Maximum frequency (F03)

F31/F35 data	[FMA] output	Data	Definition of monitor amount 100%
17	Position error in master-follower operation	Deviation in angle	0% to 50% to 100%, representing a deviation of -180° to 0° to +180° respectively
18	Inverter heat sink temperature	Heat sink detection temperature of inverter	200°C/100%
21	PG feedback value	Actual speed (When PG interface option card is mounted, the speed is always calculated and output regardless of the control method.)	Maximum speed as 100%
111	Customizable logic output signal 1	Enable only at analog output	100% / 100%
112	Customizable logic output signal 2	Enable only at analog output	100% / 100%
113	Customizable logic output signal 3	Enable only at analog output	100% / 100%
114	Customizable logic output signal 4	Enable only at analog output	100% / 100%
115	Customizable logic output signal 5	Enable only at analog output	100% / 100%
116	Customizable logic output signal 6	Enable only at analog output	100% / 100%
117	Customizable logic output signal 7	Enable only at analog output	100% / 100%
118	Customizable logic output signal 8	Enable only at analog output	100% / 100%
119	Customizable logic output signal 9	Enable only at analog output	100% / 100%
120	Customizable logic output signal 10	Enable only at analog output	100% / 100%

Note If F31 = 16 (PID output), J01 = 3 (Dancer control), and J62 = 2 or 3 (Ratio compensation enabled), the PID output is equivalent to the ratio against the primary reference frequency and may vary within 300% of the frequency. The monitor displays the PID output in a converted absolute value (%). To indicate the value up to the full-scale of 300%, set F30 data to "33" (%).

■ **Pulse rate (F33)**

F33 specifies the pulse rate at which the output of the monitored item selected reaches 100%, in accordance with the modes of the pulse counter to be connected.

- Data setting range: 25 to 32000 (pulse/s)

Pulse output waveform

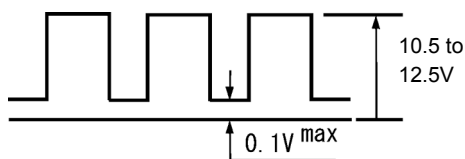

Pulse output circuit

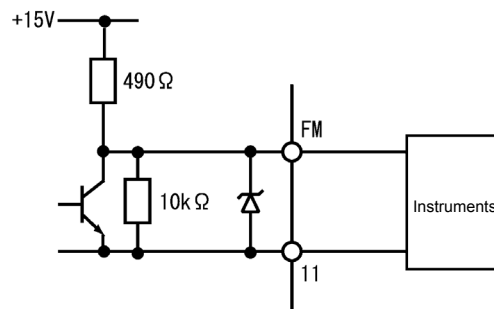

F37	Load Selection/Auto Torque Boost/Auto Energy Saving Operation 1 Related function codes: F09 Torque boost 1
------------	---

F37 specifies V/f pattern, torque boost type, and auto energy saving operation in accordance with the characteristics of the load.

F37 data	V/f characteristics	Torque boost	Auto Energy-saving Operation	Applicable load
0	Variable torque V/f pattern	By F09 torque boost	Disabled	Variable torque load (General-purpose fan and pumps)
1	Linear V/f pattern			Constant torque load
2				Auto torque Boost
3	Variable torque V/f pattern	By F09 torque boost	Enabled	Variable torque load (General-purpose fan and pumps)
4	Linear V/f pattern			Constant torque load
5				Auto torque Boost

Note If a required “load torque + acceleration torque” is 50% or more of the rated torque, it is recommended to select the linear V/f pattern. Factory defaults are set to linear V/f pattern.

■ V/f characteristics

The FRENIC-Ace series of inverters offer a variety of V/f patterns and torque boosts, which include V/f patterns suitable for variable torque load such as general fans and pumps and for constant torque load (including special pumps requiring high starting torque). Two types of torque boosts are available: manual and automatic.

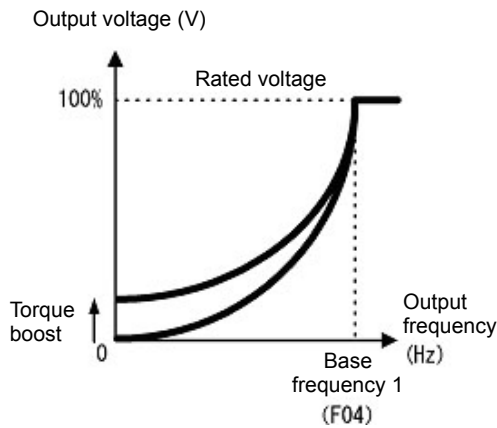

Variable torque V/f pattern (F37 = 0)

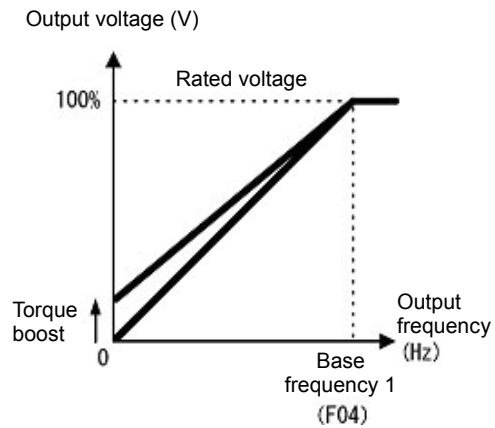

Linear V/f pattern (F37 = 1)



When the variable torque V/f pattern is selected (F37 = 0 or 3), the output voltage may be low at a low frequency zone, resulting in insufficient output torque, depending on the characteristics of the motor and load. In such a case, it is recommended to increase the output voltage at the low frequency zone using the non-linear V/f pattern.

Recommended value: H50 = 1/10 of the base frequency
 H51 = 1/10 of the voltage at base frequency

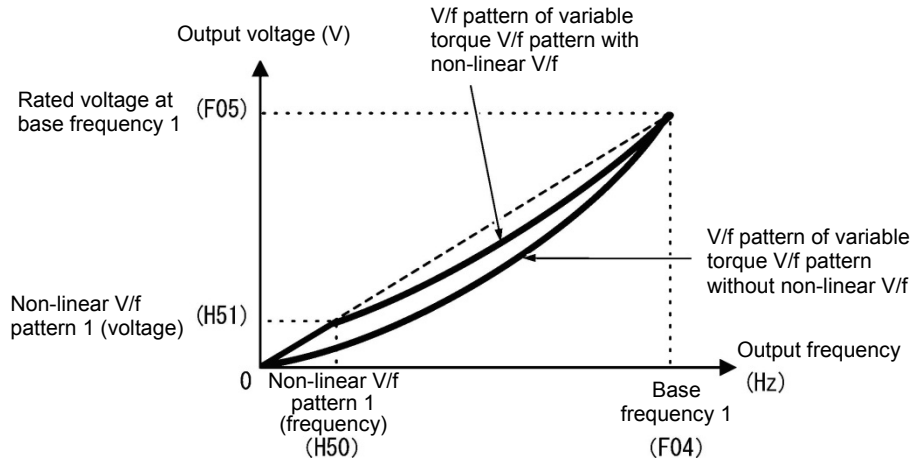

■ Torque boost

• Manual torque boost by F09 (Manual adjustment)

- Data setting range: 0.0 to 20.0 (%), (100%/base frequency voltage)

In torque boost using F09, constant voltage is added to the basic V/f pattern, regardless of the load. To secure a sufficient starting torque, manually adjust the output voltage to optimally match the motor and its load by using F09. Specify an appropriate level that guarantees smooth Startup and yet does not cause over-excitation at no or light load.

Torque boost using F09 ensures high driving stability since the output voltage remains constant regardless of the load fluctuation.

Specify the function code F09 data in percentage to the base frequency voltage. At factory shipment, boost amount with which approx. 100% of starting torque can be assured, is specified.



- Specifying a high torque boost level will generate a high torque, but may cause overcurrent due to over-excitation at no load. If you continue to drive the motor, it may overheat. To avoid such a situation, adjust torque boost to an appropriate level.
- When the non-linear V/f pattern and the torque boost are used together, the torque boost takes effect below the frequency on the non-linear V/f pattern's point.

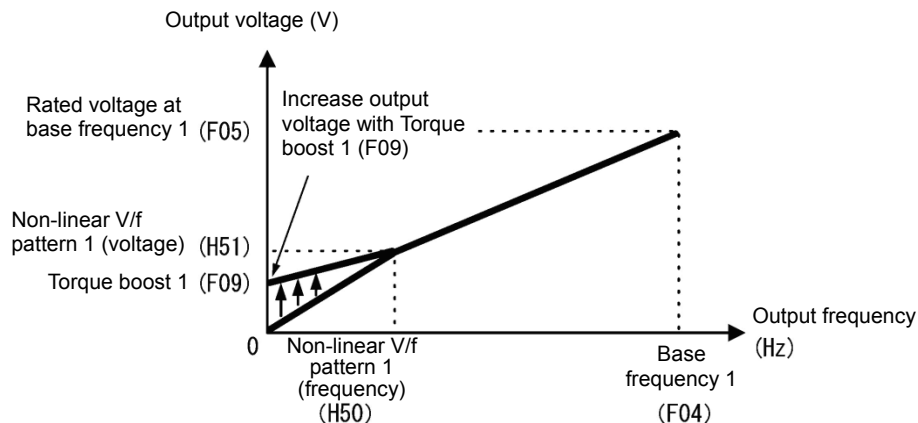

• **Auto torque boost**

This function automatically optimizes the output voltage to fit the motor with its load. Under light load, auto torque boost decreases the output voltage to prevent the motor from over-excitation. Under heavy load, it increases the output voltage to increase the output torque of the motor.

- Note**
- This function controls in accordance with motor characteristics. Therefore, set the base frequency 1 (F04), rated voltage at base frequency 1 (F05), and other pertinent motor parameters (P01 through P03 and P06 through P99) in line with the motor capacity and characteristics, or else perform auto-tuning (P04).
 - When a special motor is driven or the load does not have sufficient rigidity, the maximum torque might decrease or the motor operation might become unstable. In such cases, do not use auto torque boost but choose manual torque boost using F09 (F37 = 0 or 1).

F38, F39	Stop frequency (Detection mode and holding time)	Refer to F23.
-----------------	---	----------------------

For details about the setting of the stop frequency (detection mode and holding time), refer to the description of F23.

F40, F41	<p>Torque limiter 1 (Driving), Torque limiter 1 (Braking)</p> <p>Related function codes:</p> <p>E16, E17 Torque limiter 2 (Driving), Torque limiter 2 (Braking)</p> <p>H74 Torque limiter (Control target)</p> <p>H76 Torque control (Braking) (Frequency rising limit for braking)</p>
-----------------	--

Under V/f control (F42=0,1,2,3,4)

If the inverter output torque exceeds the specified levels of the torque limiters (F40, F41, E16, E17, and E61 to E63), the inverter controls the output frequency and limits the output torque for preventing a stall.

To use the torque limiters, it is necessary to configure the function codes listed in Table 5.3-5.

- Note** In braking, the inverter increases the output frequency to limit the output torque. Depending on the conditions during operation, the output frequency could dangerously increase. H76 (Frequency rising limit for braking) is provided to limit the increasing frequency component.

Table 5.3-5 Related function codes

Function code	Name	V/f control	Remarks
F40	Torque limiter 1 (Driving)	Y	
F41	Torque limiter 1 (Braking)	Y	
E16	Torque limiter 2 (Driving)	Y	
E17	Torque limiter 2 (Braking)	Y	
H74	Torque limiter (Control target)	N	
H76	Torque limiter (Frequency rising limit for braking)	Y	
E61 to E63	Terminal [12], [C1] (C1 function) • (V2 function) Extension function selection	Y	7: Analog torque limit value A 8: Analog torque limit value B

■ **Torque limit control mode**

Torque limit is performed by limiting torque current flowing across the motor.

The graph below shows the relationship between the torque and the output frequency at the constant torque current limit.

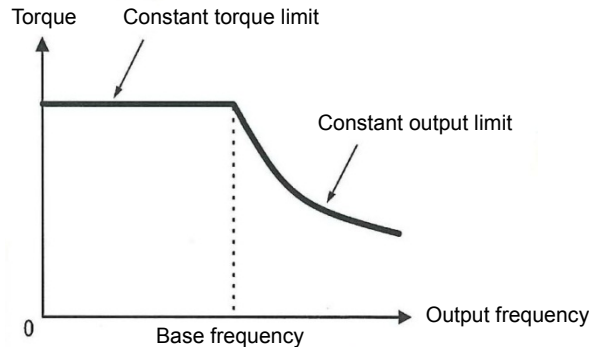

■ **Torque limiter (F40, F41, E16, E17) Data setting range: 0 to 300%; 999 (Disable)**

These function codes specify the operation level at which the torque limiters become activated, as the percentage of the motor rated torque.

Function code	Name	Torque limit feature
F40	Torque limiter 1 (Driving)	Driving torque current limiter 1
F41	Torque limiter 1 (Braking)	Braking torque current limiter 1
E16	Torque limiter 2 (Driving)	Driving torque current limiter 2
E17	Torque limiter 2 (Braking)	Braking torque current limiter 2



Although the setting range of the torque is 300%, the torque limiter determined by the overload current of the unit internally limits the torque current output. Therefore, the torque current output is automatically limited at a value lower than 300%, the maximum setting value.

■ **Analog torque limiter (E61 to E63)**

The torque limit value can be specified by analog inputs (voltage or current) through terminals [12], [C1] (C1 function), and [C1] (V2 function). Assign by Extension function selection function codes E61, E62, E63 (Terminal [12], [C1] (C1 function), [C1] (V2 function) as follows.

E61, E62, E63 data	Function	Description
7	Analog torque limiter A	Used when analog inputs are used as torque limiters. Input modes: 200% / 10 V or 20 mA
8	Analog torque limiter B	

If these terminals have been set up to have the same data, the operation priority is given in the following order: E61 > E62 > E63

Refer to E59 on how to use terminals [C1] (C1 function) and [C1] (V2 function).

■ **Torque limiter levels specified via communications link (S10, S11)**

The torque limiter levels can be changed via the communications link. Communication dedicated codes S10, S11 interlock with the function codes F40, F41.

■ Switching torque limiters

The torque limiters can be switched by the function code setting and the terminal command "TL2/TL1" (Select torque limiter level 2/1) assigned to any of the digital input terminals. To assign the Torque limiter 2/Torque limiter 1, "TL2/TL1" set Data = 14 in function codes from E01 to E05. If no "TL2/TL1" is assigned, torque limiter levels 1-1 and 1-2 (F40 and F41) take effect by default.

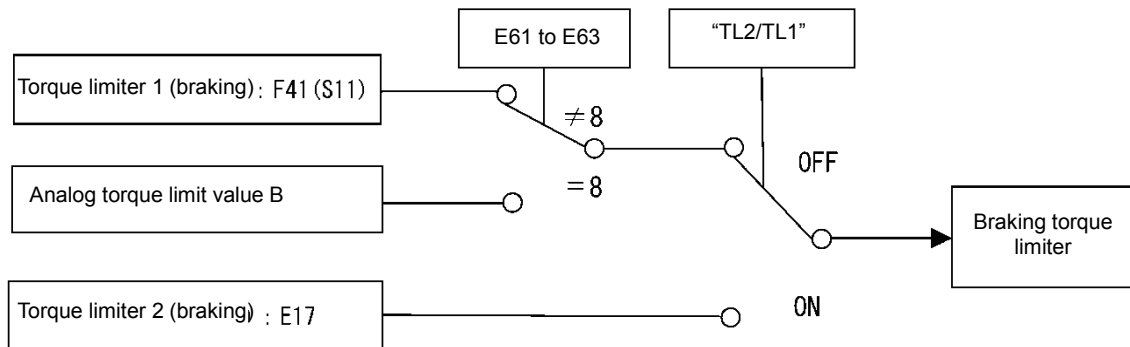
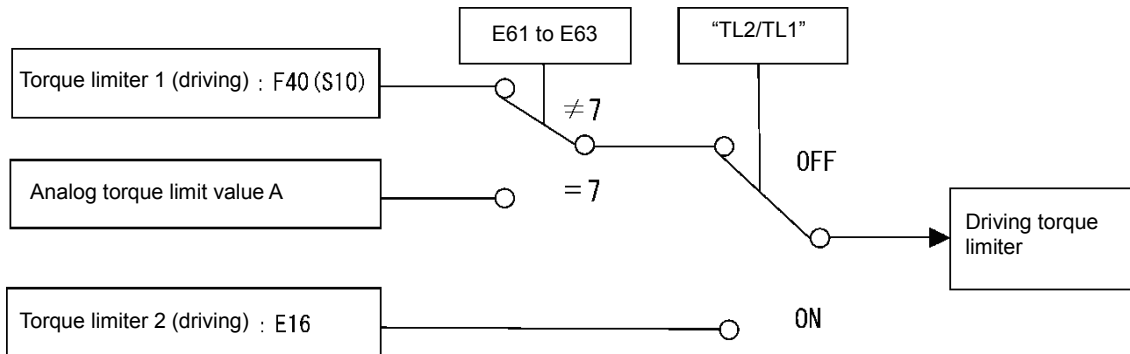

■ Torque limiter (Braking) (Frequency rising limit for braking) (H76) Data setting range: 0.0 to 500.0 (Hz)

H76 specifies the rising limit of the frequency in limiting torque for braking. The Factory defaults are 5.0 Hz. If the increasing frequency during braking reaches the limit value, the torque limiters no longer function, resulting in an overvoltage trip. Such a problem may be avoided by increasing the setting value of H76.

Note The torque limiter and current limiter are very similar in function. If both are activated concurrently, they may conflict with each other and cause hunting. Avoid concurrent activation of these limiters.

Under vector control with speed sensor (F42=6)

If the inverter's output torque exceeds the specified levels of the torque limiters (F40, F41, E16, E17, and E61 to E63), the inverter controls the speed regulator's output (torque command) in speed control or a torque command in torque control in order to limit the motor-generating torque.

To use the torque limiters, it is necessary to configure the function codes listed in the Table 5.3-6.

Table 5.3-6 Related function codes

Function code	Name	Vector control	Remarks
F40	Torque limiter 1 (Driving)	Y	
F41	Torque limiter 1 (Braking)	Y	
E16	Torque limiter 2 (Driving)	Y	
E17	Torque limiter 2 (Braking)	Y	
H74	Torque limiter (Control target)	Y	
E61 to E63	Terminal [12], [C1] (C1 function) • (V2 function) Extension function selection	Y	
			7: Analog torque limit value A 8: Analog torque limit value B

■ **Torque limiter (Control target) (H74)**

Under vector control, the inverter can limit motor-generating torque or output power, as well as a torque current (default).

Data for H74	Control target
0	Motor-generating torque limit
1	Torque current limit

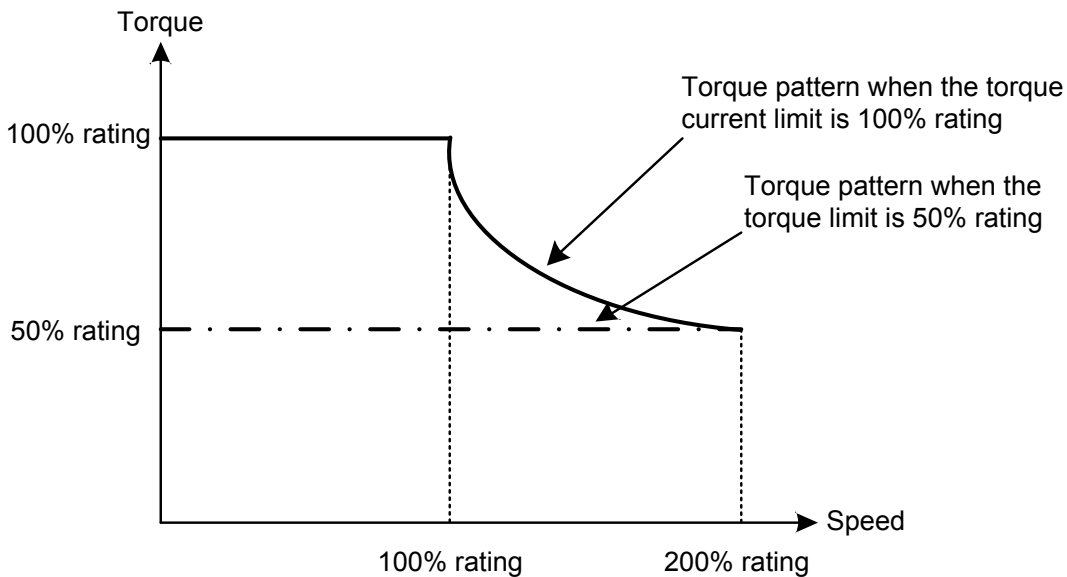

■ Torque limiters 1 (Driving, Braking), and 2 (Driving, Braking) (F40, F41, E16 and E17)

- Data setting range: 0 to 300 (%), 999 (Disable)

These function codes specify the operation level at which the torque limiters become activated, as the percentage of the motor rated torque.

Function code	Name
F40	Torque limiter 1 (Driving)
F41	Torque limiter 1 (Braking)
E16	Torque limiter 2 (Driving)
E17	Torque limiter 2 (Braking)

 The torque limiter determined depending on the overload current actually limits the torque current output. Therefore, the torque current output is automatically limited at a value lower than 300%, the maximum setting value.

■ Analog torque limiter (E61 to E63)

The torque limit value can be specified by analog inputs (voltage or current) through terminals [12], [C1] (C1 function), and [C1] (V2 function). Assign by Extension function selection function codes E61, E62, E63 (Terminal [12], [C1] (C1 function), [C1] (V2 function) as follows.

E61, E62, E63 data	Function	Description
7	Analog torque limiter A	Used when analog inputs are used as torque limiters. Input modes: 200% / 10 V or 20 mA
8	Analog torque limiter B	

If these terminals have been set up to have the same data, the operation priority is given in the following order: E61 > E62 > E63

Refer to E59 on how to use terminals [C1] (C1 function) and [C1] (V2 function).

■ Torque limiter levels specified via communications link (S10, S11)

The torque limiter levels can be changed via the communications link. Function codes S10 and S11 exclusively reserved for the communications link correspond to function codes F40 and F41.

■ **Switching torque limiters**

The torque limiters can be switched by the function code setting and the terminal command “TL2/TL1” (Select torque limiter level 2/1) assigned to any of the digital input terminals. To assign the Torque limiter 2/Torque limiter 1, “TL2/TL1” set Data = 14 by function codes from E01 to E05. If no “TL2/TL1” is assigned, torque limiter levels 1-1 and 1-2 (F40 and F41) take effect by default.

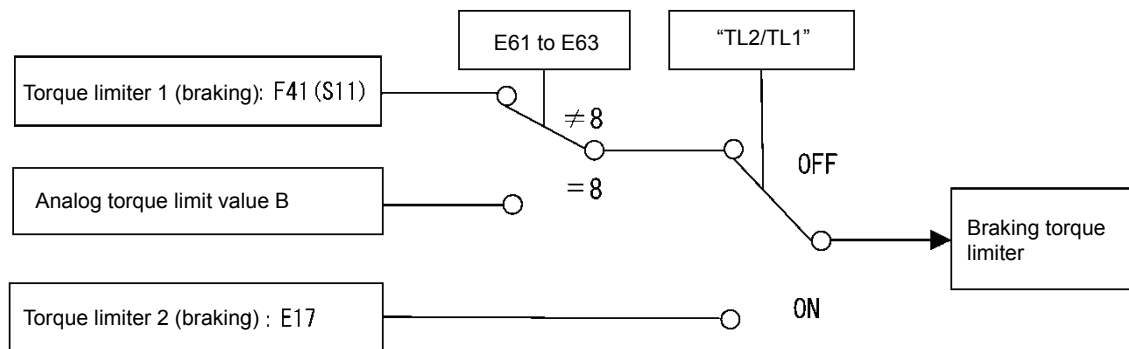
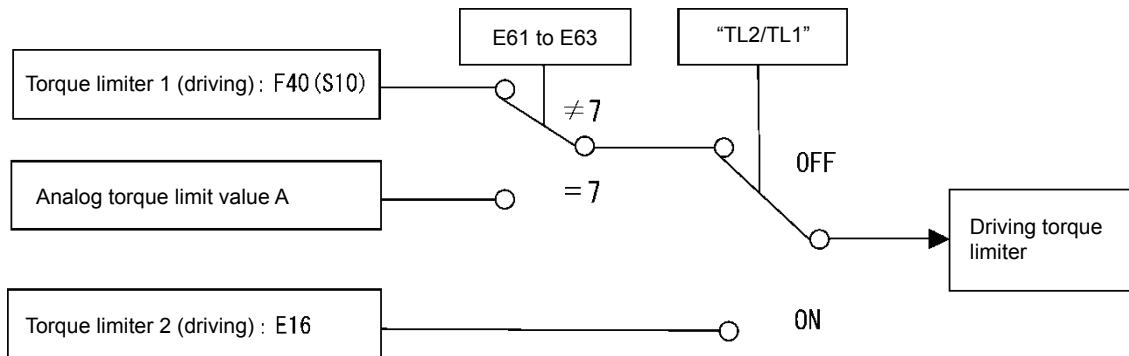

Note The torque limiter and current limiter are very similar in function. If both are activated concurrently, they may conflict with each other and cause hunting (undesirable oscillation of the system). Avoid concurrent activation of these limiters.

Under vector control without speed sensor nor pole position sensor

When a PMSM is driven under vector control without speed sensor nor pole position sensor, the torque limiters are used like as IM driven under vector control without speed sensor.

Note When switching control target motor and control method with the function code F42, the Factory defaults are also switched.

The factory default for PMSM is 200%.

Table 5.3-7 Related function codes

Function code	Name	Vector control	Remarks
F40	Torque limiter 1 (Driving)	Y	Factory defaults are “200%” (F42=15)
F41	Torque limiter 1 (Braking)	Y	
E16	Torque limiter 2 (Driving)	Y	Factory defaults are “999”
E17	Torque limiter 2 (Braking)	Y	
E61 to E63	Terminal [12], [C1] (C1 function) • (V2 function) Extension function selection	Y	7: Analog torque limit value A 8: Analog torque limit value B

F42	Drive control selection 1 Related function codes: H68 Slip Compensation 1 (Operating conditions)
------------	---

F42 specifies the motor drive control.

F42 data	Control mode	Basic control	Speed feedback	Speed control
0	V/f control without slip compensation	V/f control	Disable	Frequency control
1	Vector control without speed sensor (dynamic torque vector)			With slip compensation Frequency control
2	V/f control with slip compensation		Enable	Frequency control with automatic speed regulator (ASR)
3	V/f control with speed sensor			Speed control with automatic speed regulator (ASR)
4	V/f control with speed sensor and auto torque boost	Vector control	Estimated speed	Speed control with automatic speed regulator (ASR)
6	Vector control for induction motor with speed sensor			Speed control with automatic speed regulator (ASR)
15	Vector control for synchronous motor without speed sensor nor pole position sensor			

■ V/f control without slip compensation (F42=0)

Under this control, the inverter controls a motor with the voltage and frequency according to the V/f pattern specified by function codes. This control disables all automatically controlled features such as the slip compensation, so no unpredictable output fluctuation occurs, enabling stable operation with constant output frequency.

■ V/f control with slip compensation (F42=2)

Applying any load to an induction motor causes a rotational slip due to the motor characteristics, decreasing the motor rotation. The inverter's slip compensation function first presumes the slip value of the motor based on the motor torque generated and raises the output frequency to compensate for the decrease in motor rotation. This prevents the motor from decreasing the rotation due to the slip.

That is, this function is effective for improving the motor speed control accuracy.

Function code		Action
P12	Rated slip frequency	Specify the rated slip frequency.
P09	Slip compensation gain for driving	Adjust the slip compensation amount for driving. Slip compensation amount for driving = Rated slip x Slip compensation gain for driving
P11	Slip compensation gain for braking	Adjust the slip compensation amount for braking. Slip compensation amount for braking = Rated slip x Slip compensation gain for braking
P10	Slip compensation response time	Specify the slip compensation response time. Basically, there is no need to modify the setting.

To improve the accuracy of slip compensation, perform auto-tuning.

H68 enables or disables the slip compensation function 1 according to the motor driving conditions.

H68 data	Motor driving conditions		Motor driving frequency zone	
	Accel / Decel	During constant speed	Base frequency or below	Above the base frequency
0	Enable	Enable	Enable	Enable
1	Disable	Enable	Enable	Enable
2	Enable	Enable	Enable	Disable
3	Disable	Enable	Enable	Disable

■ Vector control without speed sensor (dynamic torque vector) (F42=1)

To get the maximal torque out of a motor, this control calculates the motor torque matched to the load applied and uses it to optimize the voltage and current vector output.

When the vector control without speed sensor (dynamic torque vector) is selected, automatically auto torque boost and slip compensation become enabled. This control is effective for improving the system response to external disturbances such as load fluctuations, and the motor speed control accuracy.

Note that the inverter may not respond to a rapid load fluctuation.



For slip compensation in case of vector control without speed sensor, constants of motor are used. Therefore, satisfy the following conditions below. If these conditions cannot be satisfied, sufficient control performance may not be obtained.

- A single motor is controlled per inverter.
- The prerequisite is that motor parameter P02, P03, P06 to P13 are accurately set or auto-tuning is performed.
- Under vector control without speed sensor, the capacity of the motor to be controlled must be not less than two ranks lower of the nominal applied motor capacity. Otherwise, the inverter may not control the motor due to decrease of the current detection resolution.
- The wiring distance between the inverter and motor should be 50 m (164 ft) or less. If it is longer, the inverter may not control the motor due to leakage current flowing through stray capacitance to the ground or between wires. Especially, small capacity inverters whose rated current is also small may be unable to control the motor correctly even if the wiring is less than 50 m (164 ft). In that case, make the wiring length as short as possible or use a wire with small stray capacitance (e.g., loosely-bundled cable) to minimize the stray capacitance.

■ V/f control with speed sensor (F42=3)

Applying any load to an induction motor causes a rotational slip due to the motor characteristics, decreasing the motor rotation. Under V/f control with speed sensor, the inverter detects the motor rotation using the encoder mounted on the motor shaft and compensates for the decrease in slip frequency by the PI control to match the motor rotation with the reference speed. This improves the motor speed control accuracy.

■ V/f control with speed sensor and auto torque boost (F42=4)

The difference from “V/f control with speed sensor” stated above is to calculate the motor torque that matches to the load applied, and use it to optimize the voltage and current vector output for getting the maximal torque from the motor.

This control is effective for improving the system response to external disturbances such as load fluctuations, and the motor speed control accuracy.

■ Vector control for synchronous motor without speed sensor nor pole position sensor (F42=15)

This control estimates the motor speed based on the inverter's output voltage and current, and uses the estimated speed for speed control. It also decomposes the motor drive current into the exciting and torque current components, and controls each of those components as vectors. No PG (pulse generator) interface card is required. It is possible to obtain the desired response by adjusting the control constants (PI constants) using the speed regulator (PI controller).



When changing function code F42 to data 15 “Vector control for synchronous motor without speed sensor nor pole position sensor” by the keypad, then the inverter automatically updates data of F03,F04,F05 and others.

■ Vector control with speed sensor (F42=6)

This control requires an optional PG (pulse generator) and an optional PG interface card to be mounted on a motor shaft and an inverter, respectively. The inverter detects the motor's rotational position and speed according to PG feedback signals and uses them for speed control. It also decomposes the motor drive current into the exciting and torque current components, and controls each of components as vectors.

It is possible to obtain the desired response by adjusting the control constants (PI constants) using the speed regulator (PI controller).

The control method performs speed control with higher accuracy and quicker response than vector control without speed sensor.



Since slip compensation, dynamic torque vector control, and vector control with speed sensor use motor parameters, the following conditions should be satisfied to obtain full control performance.

- A single motor is controlled per inverter.
- Motor parameters P02, P03, P06 to P20, P55 and P56 are properly configured. Or, auto-tuning (P04) is performed.
- Under vector control without speed sensor, the capacity of the motor to be controlled must be not less than two ranks lower of the nominal applied motor capacity; under vector control with speed sensor, it is the same as that of the nominal applied motor capacity. Otherwise, the inverter may not control the motor due to decrease of the current detection resolution.
- The wiring distance between the inverter and motor should be 164 ft (50 m) or less. If it is longer, the inverter may not control the motor due to leakage current flowing through stray capacitance to the ground or between wires. Especially, small capacity inverters whose rated current is also small may be unable to control the motor correctly even if the wiring is less than 164 ft (50 m). In that case, make the wiring length as short as possible or use a wire with small stray capacitance (e.g., loosely-bundled cable) to minimize the stray capacitance.

■ **Control parameters which are initialized when the control method F42 is changed**

When control method (F42) is switched between synchronous motor and induction motor, the data of related function codes are also switched to the default value. See the table below.

Function code	Switch F42 between 15 and others	Change P02	H03=2 with F42=0 to 4,6	H03=2 with F42=15
F03	Y	N	N	N
F04	Y	N	N	Y
F05	Y	N	N	Y
F06	Y	N	N	Y
F10	N	N	N	Y
F11	Y	N	N	Y
F12	Y	N	N	Y
F15	Y	N	N	N
F23	Y	N	N	N
F26	Y	N	N	N
F40 to F41	Y	N	N	N
E50	Y	N	N	N
P01	Y	N	Y	Y
P02	N	N	N	N
P03	Y	Y	Y	Y
P05 to P13	N	Y	Y	Y
P16-P20	N	Y	Y	Y
P30	N	Y	Y	Y
P53	N	Y	Y	Y
P55 to P56	N	Y	Y	Y
P60 to P64	N	Y	Y	Y
P65	N	Y	Y	Y
P74	N	Y	Y	Y
P83	N	Y	Y	Y
P84	N	Y	Y	Y
P85	N	Y	Y	Y
P87 to P89	N	Y	Y	Y
P90	N	Y	Y	Y
P99	Y	N	N	N
H46	N	Y	Y	Y
d01 to d04	Y	N	N	N

Y: Switched N: Not switched

F43, F44**Current limiter (Mode selection and Level)****Related function codes: H12 Instantaneous overcurrent limiting (Mode selection)**

When the output current of the inverter exceeds the level specified by the current limiter (F44), the inverter automatically manages its output frequency to prevent a stall and limits the output current. According to limit value based on Inverter's rated current, the default setting of the current limiter is 160% for HHD/HD mode, and 130% for HND/ND mode, respectively (Initial value is automatically written when selecting ND/HD/HND/HHD by function code F80) If overload current, higher than the current limiter level, flows instantaneously so that the output frequency decrease due to the current limiter causes a problem, consider to increase the current limiter level.

The current limiter mode should be also selected with F43. If F43 = 1, the current limiter is enabled only during constant speed operation. If F43 = 2, it is enabled during both of acceleration and constant speed operation. Choose F43 = 1 if you need to run the inverter at full capability during acceleration and to limit the output current during constant speed operation.

■ Mode selection (F43)

F43 selects the motor running state in which the current limiter becomes active.

F43 data	Running states that enable the current limiter		
	During acceleration	During constant speed	During deceleration
0	Disabled	Disabled	Disabled
1	Disabled	Action	Disabled
2	Action	Action	Disabled

■ Level (F44)

F44 specifies the operation level at which the output current limiter becomes activated, as a ratio of the inverter rating.

- Data setting range: 20 to 200 (%) of rated current of the inverter
(Inverter's rated current changes according to the setting value of function code F80.)

■ Instantaneous overcurrent limiting (Mode selection) (H12)

H12 specifies whether the inverter invokes the current limit processing or enters the overcurrent trip when its output current exceeds the instantaneous overcurrent limiting level. Under the current limit processing, the inverter immediately turns OFF its output gate to suppress the further current increase and continues to control the output frequency.

H12 data	Function
0	Disable (An overcurrent trip occurs at the instantaneous overcurrent limiting level.)
1	Enable (An instantaneous overcurrent limiting operation is activated)

If any problem could occur when the motor torque temporarily drops during current limiting processing, it is necessary to cause an overcurrent trip (H12 = 0) and actuate a mechanical brake at the same time.



- Since the current limit operation with F43 and F44 is performed by software, it may cause a delay in control. If you need a quick response current limiting, also enable the instantaneous overcurrent limiting with H12.
- If an excessive load is applied when the current limiter operation level is set extremely low, the inverter will rapidly lower its output frequency. This may cause an overvoltage trip or dangerous turnover of the motor rotation due to undershooting. Depending on the load, extremely short acceleration time may activate the current limiting to suppress the increase of the inverter output frequency, causing hunting (undesirable oscillation of the system) or activating the inverter overvoltage trip (alarm \overline{OL}). When specifying the acceleration time, therefore, you need to take into account machinery characteristics and moment of inertia of the load.



- The torque limiter and current limiter are very similar in function. If both are activated concurrently, they may conflict with each other and cause hunting. Avoid concurrent activation of these limiters.
- Vector control with speed sensor itself contains the current control system, so it disables the current limiter specified by F43 and F44, as well as automatically disabling the instantaneous overcurrent limiting (specified by H12). Accordingly, the inverter causes an overcurrent trip when its output current exceeds the instantaneous overcurrent limiting level.

F50 to F52**Electronic thermal overload protection for braking resistor
(Discharging capability, Allowable average loss and Braking resistance value)**

These function codes specify the electronic thermal overload protection feature for the braking resistor.

Set the discharging capability, allowable average loss and resistance to F50, F51 and F52, respectively. These values are determined by the inverter and braking resistor models. For the discharging capability, allowable average loss and resistance, refer to Chapter 11 "11.8.4 Specifications."

The values listed in the tables are for standard models and 10% ED models of the braking resistors which Fuji Electric provides. When using a braking resistor of any other manufacturer, confirm the corresponding values with the manufacturer and set the function codes accordingly.

Set 0.00 to F52 when replacing from FRENIC-Multi.



Depending on the thermal characteristics of the braking resistor, the electronic thermal overload protection feature may act so that the inverter issues the overheat protection alarm *o/h* even if the actual temperature rise is not large enough. If this happens, review the relationship between the performance index of the braking resistor and settings of related function codes.



Using the standard models of braking resistor or using the braking unit and braking resistor together can output temperature detection signal for overheat. Assign terminal command THR ("Enable external alarm trip") to any of digital input terminals [X1] to [X5], [FWD] and [REV] and connect that terminal and its common terminal to braking resistor's terminals 2 and 1.

Calculating the discharging capability and allowable average loss of the braking resistor and configuring the function code data

When using any non-Fuji braking resistor, inquire to the resistor manufacturer about the resistor rating and then configure the related function codes.

The calculation procedures for the discharging capability and allowable average loss of the braking resistor differ depending on the application of the braking load as shown below.

<Applying braking load during deceleration>

In usual deceleration, the braking load decreases as the speed slows down. In the deceleration with constant torque, the braking load decreases in proportion to the speed.

Use Expressions (1) and (3) given below.

Applying braking load during running at a constant speed

Different from during deceleration, in applications where the braking load is externally applied during running at a constant speed, the braking load is constant.

Use Expressions (2) and (4) given below.

Braking load (kW)

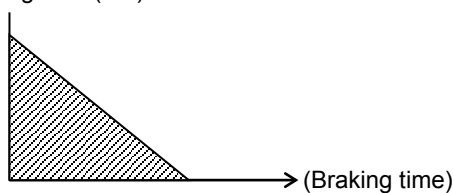

<Applying braking load during deceleration>

Braking load (kW)

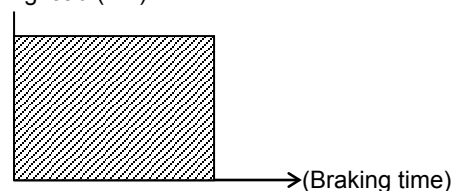

<Applying braking load during running at a constant speed>

■ Discharging capability (F50)

The discharging capability refers to kW allowance for a single braking cycle. It can be calculated from braking

F50 data	Function
1 to 9000	1 to 9000 (kW)
OFF	Disable the electronic thermal overload protection

$$\text{Discharging capability (kW)} = \frac{\text{Braking time (s)} \times \text{Motor rated capacity (kW)}}{2} \quad (1)$$

$$\text{Discharging capability (kW)} = \text{Braking time (s)} \times \text{Motor rated capacity (kW)} \quad (2)$$

■ Allowable average loss (F51)

Allowance average loss is the resistor capacitor that enables continuous operation of motor. It can be calculated from ED (%) and motor capacity (kW).

F51 data	Function
0.001 to 99.99	0.001 to 99.99 (kW)

$$\text{Allowable average loss (kW)} = \frac{\frac{\%ED(\%)}{100} \times \text{Motor rated capacity (kW)}}{2} \quad (3)$$

$$\text{Allowable average loss (kW)} = \frac{\%ED(\%)}{100} \times \text{Motor rated capacity (kW)} \quad (4)$$

■ Braking resistance value (F52)

F52 specifies the resistance of the braking resistor.

F52 data	Function
0.00	Braking resistor protection method by FRENIC-Multi series method (Resistance not required)
0.01 to 999	0.01 to 999 (Ω)

F80**Switching between ND,HD,HND and HHD drive modes**

ND is the standard mode for specifications other than J (for Japanese) model, therefore, it is possible to alleviate ambient temperature condition and increase overload capability by switching to HHD/HND/HD modes. However, rated current (applicable motor capacity) becomes one or two frames lower.

To change the data of function code F80 data, double key operation with “STOP key + /” key” is necessary.

F80 data	Drive mode	Application	Rated current level	Ambient temperature	Overload capability	Maximum output frequency
0	HHD mode	Heavy load	Capable of driving a motor whose capacity is the same as the inverter capacity.	50°C (122°F)	150% 1min, 200% 0.5s	500Hz
1	HND mode	Light load	Capable of driving a motor whose capacity is one rank higher than the inverter capacity.	50°C (122°F)	120% 1 min	500Hz
3	HD mode	Medium load	Capable of driving a motor whose capacity is one rank higher than the inverter capacity.	40°C (104°F)	150% 1 min	500Hz
4	ND mode	Light load	Capable of driving a motor whose capacity is two ranks higher than the inverter capacity.	40°C (104°F)	120% 1 min	120Hz

For the concrete rated current level, refer to Chapter 12 “SPECIFICATIONS.” Factory defaults are 0: HHD for Japan and 4: ND for other countries.

 **Note** When, by changing the mode, the motor capacity becomes 75kW or higher, make sure to connect direct current reactor (DCR) according to the motor capacity. However, it is not necessary when using PWM converter.

Failure may occur

ND, HD, HND, and HHD-mode inverters are subject to restrictions on the function code data setting range and internal processing as listed below.

Function code	Name	Remarks
F21	DC braking 1 (Braking level)	Upper limit restriction
F26	Motor sound (Carrier frequency)	Upper limit restriction
F44	Current limiter (Level)	Default setting, setting value
F03	Maximum frequency	Allowed output frequency range
A10	DC braking 2 (Braking level)	Upper limit
J68	Brake Signal Brake-release current	Upper limit

Refer to explanation of each function code and selection guidance in Chapter 10 “10.4.2 Guideline for selecting inverter drive mode and capacity.”

5.3.2 E codes (Extension terminal functions)

E01 to E05	Terminals [X1] to [X5] function Related function codes: Terminal E98 [FWD] function Terminal E99 [REV] function
------------	---

E01 to E05, E98 and E99 assign commands to general-purpose, programmable, digital input terminals, [X1] to [X5], [FWD], and [REV].

These function codes can also switch the logic system between normal and negative to define how the inverter logic interprets the ON or OFF state of each terminal. The factory default setting is normal logic system "Active ON." Functions assigned to digital input terminals [X1] to [X5], [FWD] and [REV] are as shown below. Descriptions that follow are given in normal logic system. Each signal has been described at data allocation order. However, the signal is related has been described together. Refer to the function codes in the "Related function codes" column, if any.

The FRENIC-Ace runs under "V/f: V/f control, dynamic torque vector control," "PG V/f: V/f control with speed sensor," "IM CLV: vector control with speed sensor," "IM TC: Torque control with speed sensor," or "PM SLV: vector control without speed sensor nor pole position sensor for permanent magnet synchronous motor." Some terminal commands assigned apply exclusively to the specific drive control, which is indicated by letters Y (Applicable) and N (Not applicable) in the "Control mode" column in the table given below.

⚠ CAUTION	
<ul style="list-style-type: none"> Run commands (e.g., Run forward "FWD"), stop commands (e.g., Coast to a stop "BX"), and frequency change commands can be assigned to digital input terminals. Depending on the state of digital input terminals, modifying a single function code setting may cause abrupt start of operation or significant change of the speed. Ensure safety before modifying the function code settings. Functions for switching run or frequency command sources (such as "SS1, SS2, SS4, SS8", "Hz2/Hz1", "Hz/PID", "IVS" and "LE") can be assigned to the digital input terminals. Switching these signals may cause a sudden motor start or an abrupt change in speed depending on the condition. 	
An accident or physical injury may result.	

Data		Terminal commands assigned	Symbol	Control mode					Related function codes
Active ON	Active OFF			V/f	PG V/f	IM CLV	IM TC	PM SLV	
0	1000	Select multistep frequency (1 to 15 steps)	"SS1"	Y	Y	Y	N	Y	C05 to C19
1	1001		"SS2"	Y	Y	Y	N	Y	
2	1002		"SS4"	Y	Y	Y	N	Y	
3	1003		"SS8"	Y	Y	Y	N	Y	
4	1004	Select ACC/DEC time (2 steps)	"RT1"	Y	Y	Y	N	Y	F07, F08, E10 to E15
5	1005	Select ACC/DEC time (4 steps)	"RT2"	Y	Y	Y	N	Y	
6	1006	Select 3-wire operation	"HLD"	Y	Y	Y	N	Y	F02
7	1007	Coast to a stop command	"BX"	Y	Y	Y	Y	Y	—
8	1008	Reset alarm	"RST"	Y	Y	Y	Y	Y	—
1009	9	External alarm	"THR"	Y	Y	Y	Y	Y	—
10	1010	Ready for jogging	"JOG"	Y	Y	Y	N	Y	C20 H54, H55, d09 to d13
11	1011	Select frequency setting 2/1	"Hz2/Hz1"	Y	Y	Y	N	Y	F01, C30
12	1012	Select motor 2	"M2"	Y	Y	Y	Y	Y	A42
13	-	DC braking command	"DCBRK"	Y	Y	Y	N	N	F20 to F22
14	1014	Select torque limit 2/ Torque limit 1	"TL2/TL1"	Y	Y	Y	Y	Y	F40, F41 E16, E17
15	—	Switch to commercial power (50Hz)	"SW50"	Y	Y	N	N	N	—
16	—	Switch to commercial power (60Hz)	"SW60"	Y	Y	N	N	N	—
17	1017	UP command	"UP"	Y	Y	Y	N	Y	Frequency setting: F01, C30 PID command: J02
18	1018	DOWN command	"DOWN"	Y	Y	Y	N	Y	

5.3 Description of Function Codes

Data		Terminal commands assigned	Symbol	Control mode					Related function codes
Active ON	Active OFF			V/f	PG V/f	IM CLV	IM TC	PM SLV	
19	1019	Allow function code editing (Data change enabled)	"WE-KP"	Y	Y	Y	Y	Y	F00
20	1020	Cancel PID control	"Hz/PID"	Y	Y	Y	N	Y	J01 to J19, J57 to J62
21	1021	Switch normal/inverse operation	"IVS"	Y	Y	Y	N	Y	C53, J01
22	1022	Interlock	"IL"	Y	Y	Y	Y	Y	F14
23	1023	Cancel torque control	"Hz/TRQ"	N	N	N	Y	N	H18
24	1024	Select link operation (RS-485, BUS option)	"LE"	Y	Y	Y	Y	Y	H30, y98
25	1025	Universal DI	"U-DI"	Y	Y	Y	Y	Y	—
26	1026	Select auto search for idling motor speed at starting	"STM"	Y	Y	N	N	Y	H09, d67
1030	30	Force to stop	"STOP"	Y	Y	Y	Y	Y	F07, H56
32	1032	Pre-excite	"EXITE"	N	N	Y	Y	N	H84, H85
33	1033	Reset PID integral and differential terms	"PID-RST"	Y	Y	Y	N	Y	J01 to J19, J57 to J62
34	1034	Hold PID integral term	"PID-HLD"	Y	Y	Y	N	Y	
35	1035	Select local (keypad) command	"LOC"	Y	Y	Y	Y	Y	(See Section 3.3.7)
42	1042	Activate the limit switch at start point	"LS"	Y	Y	N	N	N	J73 to J88
43	1043	Start/Reset	"S/R"	Y	Y	N	N	N	
44	1044	Switch to the serial pulse receiving mode	"SPRM"	Y	Y	N	N	N	
45	1045	Enter the return mode	"RTN"	Y	Y	N	N	N	
46	1046	Enable overload stop	"OLS"	Y	Y	Y	N	Y	J63 to 67
47	1047	Servo-lock command	"LOCK"	N	N	Y	N	N	J97 to J99
48	—	Pulse train input (Only for X5 terminal (E05))	"PIN"	Y	Y	Y	N	Y	F01, C30 d62, d63
49	1049	Pulse train sign (Other than X5 terminal (E01 to E04))	"SIGN"	Y	Y	Y	N	Y	
59	1059	Enable battery-driven operation	"BATRY/UPS"	Y	Y	Y	Y	Y	-
60	1060	Select torque bias1	"TB1"	N	N	Y	N	N	H154 to H162
61	1061	Select torque bias2	"TB2"	N	N	Y	N	N	
62	1062	Hold torque bias	"H-TB"	N	N	Y	N	N	
65	1065	Check brake	"BRKE"	Y	Y	Y	N	Y	J68 to 96
70	1070	Cancel line speed control	"Hz/LSC"	Y	Y	Y	N	N	d41
71	1071	Hold line speed control frequency in the memory	"LSC-HLD"	Y	Y	Y	N	N	
72	1072	Count the run time of commercial power-driven motor 1	"CRUN-M1"	Y	Y	Y	Y	N	H44,H94
73	1073	Count the run time of commercial power-driven motor 2	"CRUN-M2"	Y	Y	Y	Y	N	
76	1076	Select droop control	"DROOP"	Y	Y	Y	N	Y	H28
78	1078	Select speed control parameter 1	"MPRM1"	N	N	Y	Y	N	d01 to d08
79	1079	Select speed control parameter 2	"MPRM1"	N	N	Y	Y	N	
80	1080	Cancel customizable logic	"CLC"	Y	Y	Y	Y	Y	E01 to E05, U81 to U90
81	1081	Clear all customizable logic timers	"CLTC"	Y	Y	Y	Y	Y	
82	1082	Cancel anti-regenerative control	"AR-CCL"	Y	Y	Y	N	Y	H69

Data		Terminal commands assigned	Symbol	Control mode					Related function codes
Active ON	Active OFF			V/f	PG V/f	IM CLV	IM TC	PM SLV	
98	—	Run forward (Exclusively assigned to [FWD] and [REV] terminals by E98 and E99)	"FWD"	Y	Y	Y	Y	Y	F02
99	—	Run reverse (Exclusively assigned to [FWD] and [REV] terminals by E98 and E99)	"REV"	Y	Y	Y	Y	Y	
100	—	No function assigned	"NONE"	Y	Y	Y	Y	Y	U81 to U90
171	1171	PID control multistage command 1	"PID-SS1"	Y	Y	Y	N	Y	J136 to J138
172	1172	PID control multistage command 2	"PID-SS2"	Y	Y	Y	N	Y	

Note Negative logic (Active OFF) command cannot be assigned to the functions marked with "-" in the "Active OFF" column.

The "External alarm" (data = 1009) and "Force to stop" (data = 1030) are fail-safe terminal commands. In the case of "External alarm" when data = 1009, "Active ON" (alarm is triggered when ON); when data = 9, "Active OFF" (alarm is triggered when OFF).

Terminal function assignment and data setting

■ **Select multistep frequency – "SS1", "SS2", "SS4", and "SS8" (Function code data = 0, 1, 2, and 3)**

The combination of the ON/OFF states of digital input signals "SS1", "SS2", "SS4" and "SS8" selects one of 16 different frequency commands defined beforehand by 15 function codes C05 to C19 (Multistep frequency 1 to 15). With this, the inverter can drive the motor at 16 different preset frequencies. (📖 Function codes C05 to C19)

■ **Select ACC/DEC time – "RT1" and "RT2" (Function code data = 4 and 5)**

These terminal commands switch between ACC/DEC time 1 to 4 (F07, F08 and E10 through E15). (📖 Functions codes F07 and F08)

■ **Select 3-wire operation – "HLD" (Function code data = 6)**

Turning this terminal command ON self-holds the forward "FWD", reverse "REV", run command, to enable 3-wire inverter operation. (📖 Function code F02)

■ **Coast to a stop command -- "BX" (Function code data = 7)**

Turning "BX" ON immediately shuts down the inverter output. The motor coasts to a stop, without issuing any alarm.

■ **Reset alarm – "RST" (Function code data = 8)**

Turning this terminal command ON clears the ALM state--alarm output (for any alarm). Turning it OFF erases the alarm display and clears the alarm hold state. When you turn the "RST" command ON, keep it ON for 10 ms or more. This command should be kept OFF for the normal inverter operation.

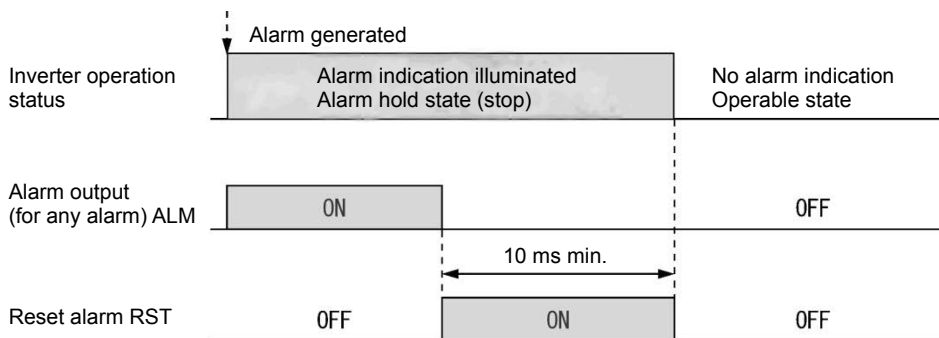

■ **External alarm – “THR” (Function code data = 9)**

Turning this terminal command OFF immediately shuts down the inverter output (so that the motor coasts to a stop), displays the alarm $\square Hz^2$, and issues the alarm output (for any alarm) ALM. The THR command is self-held, and is reset when an alarm reset takes place.



Use this alarm trip command from external equipment when you have to immediately shut down the inverter output in the event of an abnormal situation in peripheral equipment.

■ **Ready for jogging – “JOG” (Function code data = 10)**

This terminal command is used to jog or inch the motor for positioning a workpiece.

Turning this command ON makes the inverter ready for jogging. (📖 Function code C20)

■ **Select frequency setting 2/1 – “Hz2/Hz1” (Function code data = 11)**

Turning this terminal command ON and OFF switches the frequency command source between frequency setting 1 (F01) and frequency setting 2 (C30). (📖 Function code F01)

■ **Select motor 2 – “M2” (Function code data = 12)**

The terminal command M2 switches to either of the 1st and 2nd motors.

■ **DC braking command – “DCBRK” (Function code data = 13)**

This terminal command gives the inverter a DC braking command through the inverter’s digital input.

(Requirements for DC braking must be satisfied.) (📖 Function codes F20 to F22)

■ **Select torque limit 2/1 – “TL2/TL1” (Function code data = 14)**

This terminal command switches between torque limiter 1 (F40 and F41) and torque limiter 2-1, 2-2 (E16 and E17).

(📖 Function codes F40 and F41)

■ **Switch to commercial power for 50 Hz or 60 Hz – “SW50” and “SW60” (Function code data = 15 and 16)**

When an external sequence switches the motor drive power from the commercial line to the inverter, the terminal command SW50 or SW60 enables the inverter to start running the motor with the current commercial power frequency, regardless of settings of the reference/output frequency in the inverter. A running motor driven by commercial power is carried on into inverter operation. This command helps you smoothly switch the motor drive power source from the commercial power to the inverter power.

For details, refer to the table below, “Operation timing scheme”, “Example of Sequence Circuit” and “Example of Operation Time Scheme” on the following pages.

Terminal command assigned	Action	
Switch to commercial power for 50 Hz “SW50”	Starts at 50 Hz.	Do not concurrently assign both SW50 and SW60.
Switch to commercial power for 60 Hz “SW60”	Starts at 60 Hz.	

<Operation timing scheme>

- When the motor speed remains almost the same during coast-to-stop:

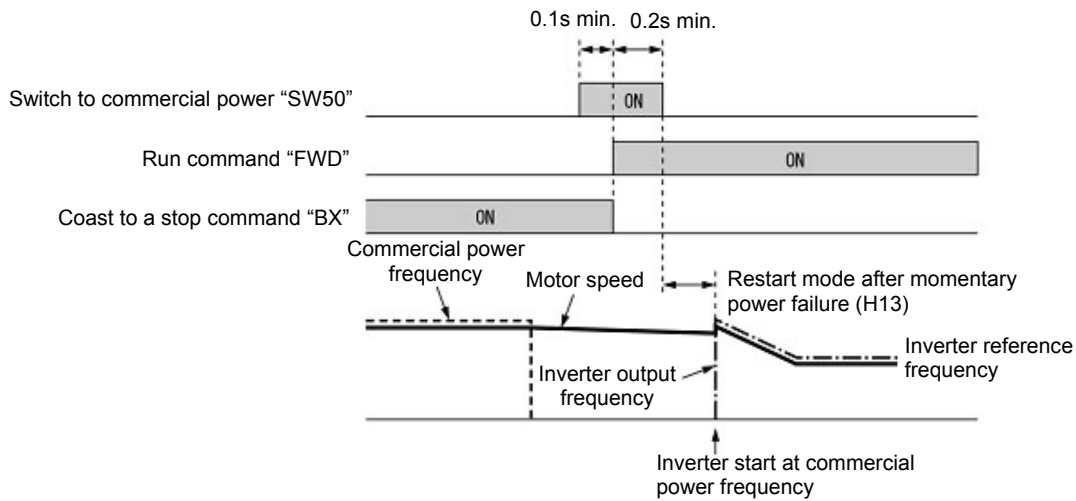

- When the motor speed decreases significantly during coast-to-stop (with the current limiter activated)

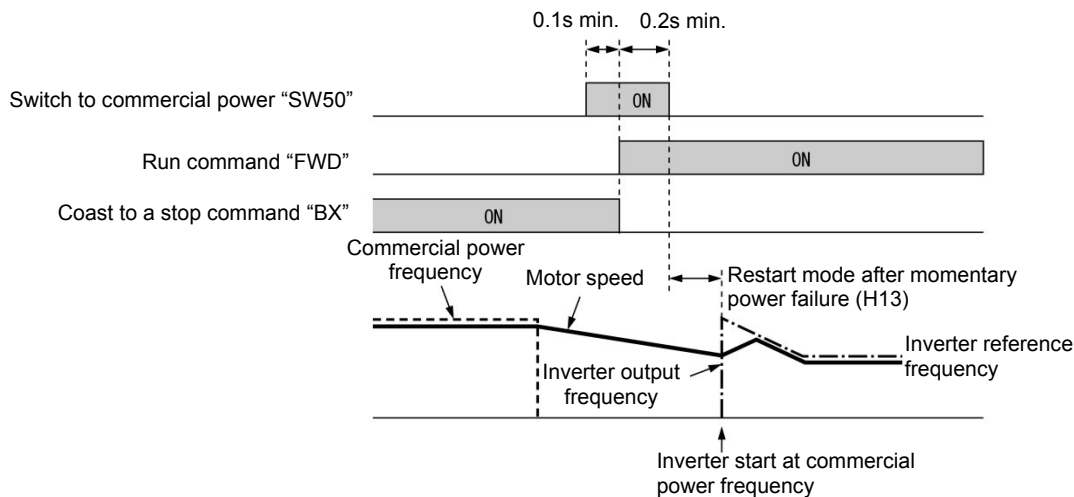

Note

- Secure more than 0.1 second after turning ON the "Switch to commercial power" signal before turning ON a run command.
- Secure more than 0.2 second of an overlapping period with both the "Switch to commercial power" signal and run command being ON.
- If an alarm has been issued or BX has been ON when the motor drive source is switched from the commercial power to the inverter, the inverter will not be started at the commercial power frequency and will remain OFF. After the alarm has been reset or "BX" turned OFF, operation at the frequency of the commercial power will not be continued, and the inverter will be started at the ordinary starting frequency.

If you wish to switch the motor drive source from the commercial line to the inverter, be sure to turn "BX" OFF before the "Switch to commercial power" signal is turned OFF.

- When switching the motor drive source from the inverter to commercial power, adjust the inverter's reference frequency at or slightly higher than that of the commercial power frequency beforehand, taking into consideration the motor speed down during the coast-to-stop period produced by switching.
- Note that when the motor drive source is switched from the inverter to the commercial power, a high inrush current will be generated, because the phase of the commercial power usually does not match the motor speed at the switching. Make sure that the power supply and all the peripheral equipment are capable of withstanding this inrush current.
- If you have enabled "Restart mode after momentary power failure" (F14 = 3, 4, or 5), keep "BX" ON during commercial power driven operation to prevent the inverter from restarting after a momentary power failure.

<Example of Sequence Circuit>

Main circuit power

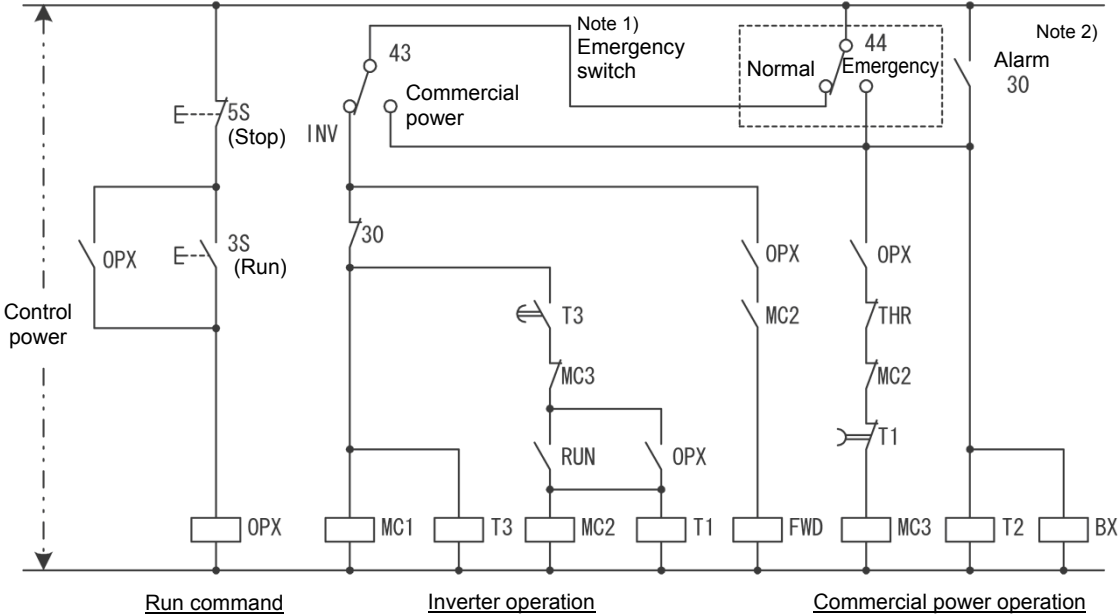
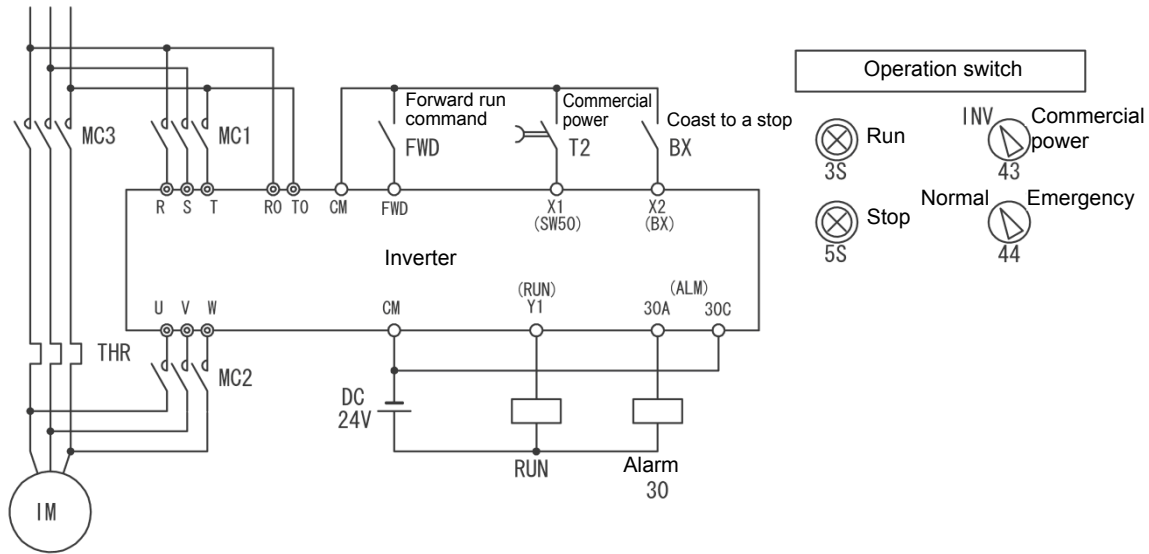

- Note 1) Emergency switch
Manual switch provided for the event that the motor drive source cannot be switched normally to the commercial power due to a serious problem of the inverter
- Note 2) When any alarm has occurred inside the inverter, the motor drive source will automatically be switched to the commercial power.

<Example of Operation Time Scheme>

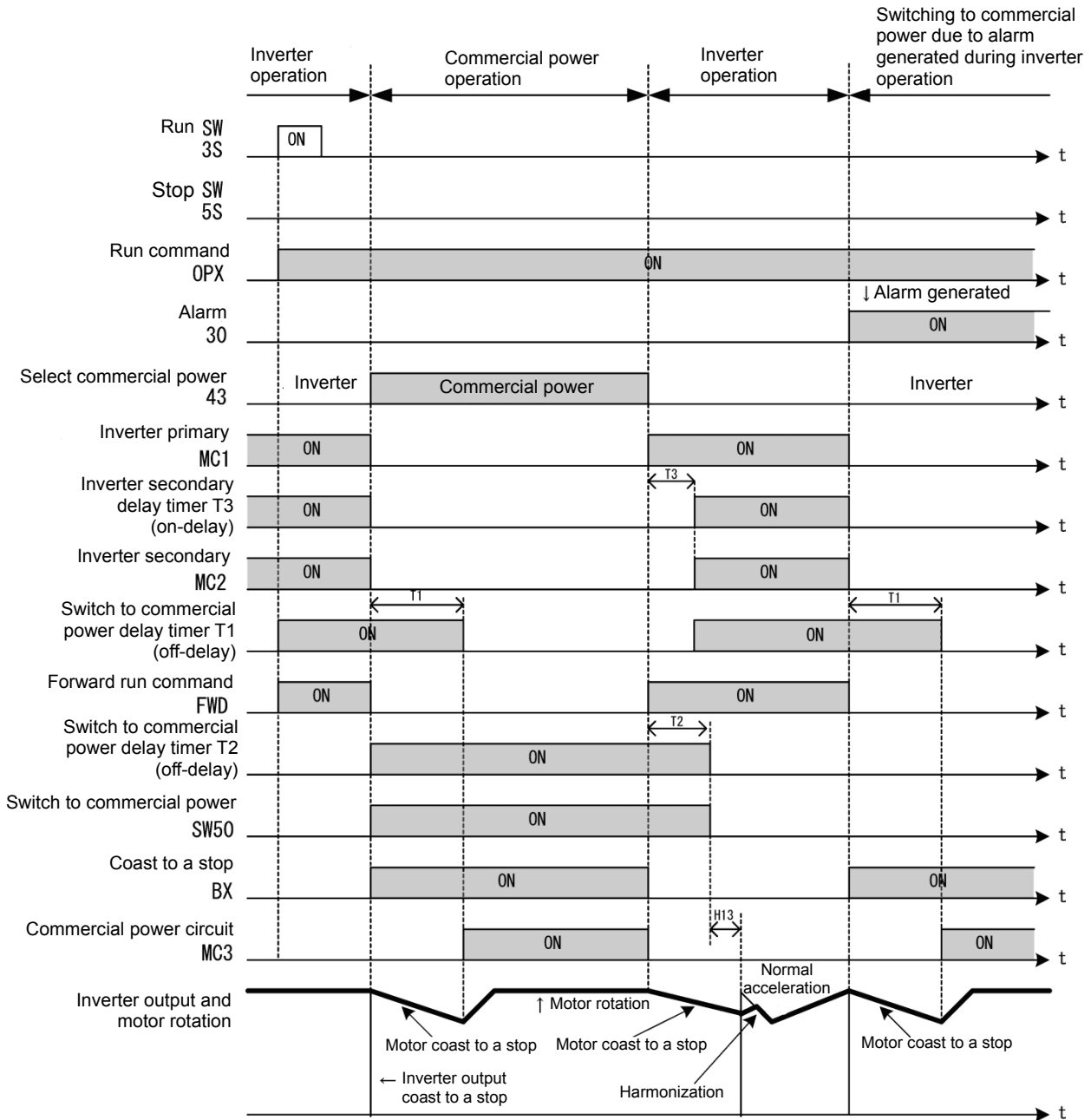

■ “UP” (Increase output frequency) and “DOWN” (Decrease output frequency) commands -- UP and DOWN (Function code data = 17 and 18)

- Frequency command: Turning the terminal command “UP” or “DOWN” ON causes the output frequency to increase or decrease, respectively, within the range from 0 Hz to the maximum frequency. (📖 Function code F01 data = 7)
- PID command: Turning the terminal command “UP” or “DOWN” ON causes the PID command value to increase or decrease, respectively, within the range from 0 to 100%. (📖 Function code J02 (data= 3))

■ Allow function code editing – “WE-KP” (Function code data = 19)

Turning the terminal command “WE-KP” OFF protects function code data from accidentally getting changed by pressing the keys on the keypad. Only when this terminal command is ON, you can change function code data from the keypad. (📖 Function code F00)

■ **Cancel PID control – “Hz/PID” (Function code data = 20)**

Turning this terminal command “Hz/PID” ON disables PID control. If the PID control is disabled with this command, the inverter runs the motor with the reference frequency manually set by any of the multistep frequency, keypad, analog input, etc.

Terminal command “Hz/PID”	Function
OFF	Enable PID control
ON	Disable PID control (Enable manual settings)

(📖 Function codes J01 to J19, J57 to J62)

■ **Switch normal/inverse operation – “IVS” (Function code data = 21)**

This terminal command switches the output frequency control between normal (proportional to the input value) and inverse in analog frequency setting or under PID process control. To select the inverse operation, turn the IVS ON.

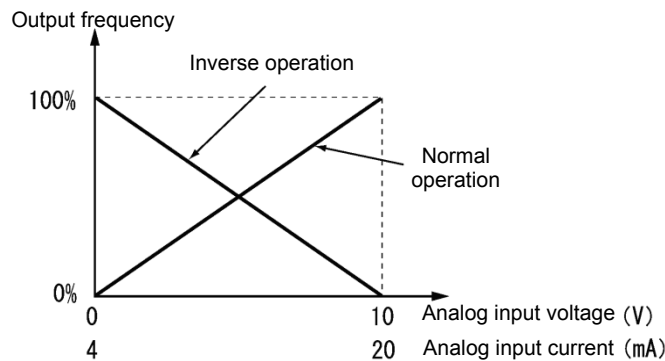

Tip The normal/inverse switching operation is useful for air-conditioners that require switching between cooling and heating. In cooling, the speed of the fan motor (output frequency of the inverter) is increased to lower the temperature. In heating, the speed of the fan motor (output frequency of the inverter) is reduced to lower the temperature. This switching is realized by the IVS.

• **When the inverter is driven by an external analog frequency setting sources (terminals [12] and [C1] (C1 function) and [C1] (V2 function)):**

Switching normal/inverse operation can apply only to the analog frequency command sources (terminals [12] and [C1] (C1 function) and [C1] (V2 function)) in frequency setting 1 (F01) and does not affect frequency setting 2 (C30) or UP/DOWN control. As shown below, the combination of the “Selection of normal/inverse operation for frequency setting 1” (C53) and the terminal command “IVS” determines the final operation.

C53 data	Terminal command “IVS”	Action
0: Normal operation	OFF	Normal
0: Normal operation	ON	Inverse
1: Inverse operation	OFF	Inverse
1: Inverse operation	ON	Normal

- **When process control is performed by the PID processor integrated in the inverter:**

The terminal command Hz/PID (“Cancel PID control”) can switch PID control between enabled (process is to be controlled by the PID processor) and disabled (process is to be controlled by the manual frequency setting). In either case, the combination of the “PID control” (J01) or “Selection of normal/inverse operation for frequency setting 1” (C53) and the terminal command IVS determines the final operation as listed Table 5.3-8 and Table 5.3-9.

Table 5.3-8 When PID control is enabled:

The normal/inverse operation selection for the PID processor output (reference frequency) is as follows.

PID control (Mode selection) (J01)	Terminal command “IVS”	Action
1: Enable (normal operation)	OFF	Normal
	ON	Inverse
2: Enable (inverse operation)	OFF	Inverse
	ON	Normal

Table 5.3-9 When PID control is disabled:

The normal/inverse operation selection for the manual reference frequency is as follows.

Selection of normal/inverse operation for frequency setting 1 (C53)	Terminal command “IVS”	Action
0: Normal operation	-	Normal
1: Inverse operation	-	Inverse



When process control is performed by the PID control facility integrated in the inverter, the “IVS” is used to switch the PID processor output (reference frequency) between normal and inverse, and has no effect on any normal/inverse operation selection of the manual frequency setting.

(📖 Function codes J01 to J19, J57 to J62)

- **Interlock – “IL” (Function code data = 22)**

In a configuration where a magnetic contactor (MC) is installed in the power output (secondary) circuit of the inverter, the momentary power failure detection feature provided inside the inverter may not be able to accurately detect a momentary power failure by itself. Using a digital signal input with the interlock command IL assures the accurate detection. (📖 Function code F14)

Terminal command “IL”	Meaning
OFF	No momentary power failure has occurred.
ON	A momentary power failure has occurred. (Restart after a momentary power failure enabled)

- **Cancel torque control -- “Hz/TRQ” (Function code data = 23)**

When torque control is enabled (H18 = 2 or 3), assigning the terminal command “Hz/TRQ” (Cancel torque control) to any of the general-purpose digital input terminals (data = 23) enables switching between speed control and torque control.

Cancel torque control signal “Hz/TRQ”	Operation
ON	Cancel torque control (Enable speed control)
OFF	Enable torque control

- **Select link operation (RS-485, BUS option) – “LE” (Function code data = 24)**

Turning this terminal command “LE” ON gives priority to frequency commands or run commands received via the RS-485 communications link (H30) or the fieldbus option (y98). No LE assignment is functionally equivalent to the “LE” being ON. (📖 Function codes H30 and y98)

■ Universal DI -- “U-DI” (Function code data = 25)

Universal DI “U-DI” assigned to digital input terminals allow to monitor signals from peripheral equipment connected to those inputs from an upper controller via an RS-485 or fieldbus communications link. Input terminals assigned to “U-DI” are simply monitored and do not operate the inverter.

 For an access to universal DI via the RS-485 or fieldbus communications link, refer to their respective Instruction Manuals.

■ Select auto search for idling motor speed at starting – “STM” (Function code data = 26)

This digital terminal command determines, at the start of operation, whether or not to search for idling motor speed and follow it. ( Function code H09)

■ Force to stop – “STOP” (Function code data = 30)

Turning this terminal command “STOP” OFF causes the motor to decelerate to a stop in accordance with the H56 data (Deceleration time for forced stop). After the motor stops, the inverter enters the alarm state with the alarm *E-5* displayed. ( Function code F07)

■ Pre-excite -- “EXITE” (Function code data = 32)

Turning this terminal command ON activates the pre-excitation feature. Even if this pre-excitation command is not assigned, specifying H85 (Pre-excitation: Time) to other than “0.00” enables the inverter to automatically start pre-excitation of the motor when it is turned ON. (This applies exclusively to the inverters under vector control with speed sensor.) ( Function codes H84 and H85.)

■ Reset PID integral and differential terms – “PID-RST” (Function code data = 33)

Turning this terminal command “PID-RST” ON resets the integral and differential components of the PID processor. ( Function codes J01 to J19, J23, J24, J57 to J62)

■ Hold PID integral term – “PID-HLD” (Function code data = 34)

Turning this terminal command “PID-HLD” ON holds the integral components of the PID processor. ( Function codes J01 to J19, J23, J24, J57 to J62)

■ Select local (keypad) command – “LOC” (Function code data = 35)

This terminal command “LOC” switches the sources of run and frequency commands between remote and local.

 For details of switching between remote and local modes, refer to Chapter 3 “3.3.7 Remote and local modes.”

■ The positioning control signals -- “LS”, “S/R”, “SPRM” and “RTN” (Function code data = 42 to 45)

( Function codes J73 to J88)

■ Enable overload stop – “OLS” (Function code data = 46)

Turning this terminal command ON enables the overload stop function; turning it OFF disables the function. If no OLS is assigned, the function is enabled. ( Function codes J63 to J67)

■ Servo-lock command -- “LOCK” (Function code data = 47)

Turning this terminal command ON enables a servo-lock command; turning it OFF disables a servo-lock command. ( Function codes J97 to J99)

■ Pulse train input – “PIN” (Only for X5 terminal (E05)) (Function code data = 48), Pulse train sign – “SIGN” (For all terminal except X5 terminal (E05)) (Function code data = 49)

Assigning the command “PIN” to digital input terminal [X5] enables the frequency command by the pulse train input. Assigning the command “SIGN” to one of the digital input terminals except [X5] enables the pulse train sign input to specify the polarity of frequency command. ( Function code F01)

■ Battery/UPS operation valid command “BATRY/UPS” (Function code data = 59)

The Battery/UPS operation can drive the motor during undervoltage situation. This can realize rescue operation which rescues the passengers from the cage stopped halfway due to power failure in the lift application.

FRENIC-Ace has two types of operation and those are selectively used depending on the inverter capacity.

When “BATRY/UPS” is assigned to the digital input terminal, the operation becomes same as F14 = 0 regardless of F14 setting, and the inverter trips immediately .

When “BATRY/UPS” is on, the input open phase protection operation becomes invalid regardless of the function code H98 bit 1 setting.

Battery/UPS operation is divided into battery operation and UPS operation. Battery operation assumes that operation is performed by supplying the main power from the battery, and control power from the UPS. Please note that depending on the inverter capacity, battery operation and UPS operation may not be possible for certain models.



- (1) Connect the battery power supply before or simultaneously with turning on the **BATRY/UPS** signal.
- (2) Between the period from turning on of the **BATRY/UPS** signal and MC2 (and power supply start from the battery) to the state that the battery operation is possible, the delay time “T1” + “T2” indicated in the above “time chart” occurs.
- (3) Do not turn on the **BATRY/UPS** signal when the voltage is same or higher than the specified undervoltage level (before $\underline{\underline{U}}$ is indicated after the power failure). If the **BATRY/UPS** signal is turned on with the voltage same or higher than the undervoltage value, the specified level, the short circuit for charging resistor 73X remains on.
- (4) During the battery operation, avoid driving with application of the heavy load. Operate with no load or braking load.
(Sufficient torque cannot be obtained by the battery voltage, and the motor may stall in such case.)
- (5) Operate the motor at a low speed, and pay attention to the battery capacity.
In addition, when the high voltage is supplied (such as when 300 VDC power supply at 200 V class inverter and 600 VDC power supply at 400 V class inverter), operate normally without the battery.
- (6) During the normal operation, it is required to turn off the **BATRY/UPS** signal. If the main power is turned on with the **BATRY/UPS** signal on, the 73X remains ON, causing the rectifier diode getting damaged.

■ **UPS operation (Available in FRN0115E2■-2□ / FRN0085E2■-4□ / FRN0012E2■-7□ or below)**

When this terminal command is turned on, the undervoltage protection is invalidated. In that case, the motor can be operated by the inverter with undervoltage status by the UPS power.

Also the function codes are able to set during UPS operation. However, please note the following.

Alarm E_r / or E_r - F may occur if power supply is turned OFF while the inverter is writing data to memory. In that case, the function code data are initialized by setting the data of H03 to "1".

Related function codes	Setting range
H111 : UPS operation Level	120 to 220 VDC: (200 V class), 240 to 440 VDC: (400 V class)

Note Prerequisite of UPS operation

- (1) Terminal function **BATRY/UPS** (data = 59) can be assigned to any digital input terminal.
- (2) As shown in Figure 5.3-5, voltage is supplied from the UPS to the main circuit (L1/R-L3/T or L2/S-L3/T).
- (3) Required voltage level will differ depending on the operation speed and load.
- (4) The terminal that **BATRY/UPS** (data = 59) is assigned has to be turned on simultaneously with the MC2.

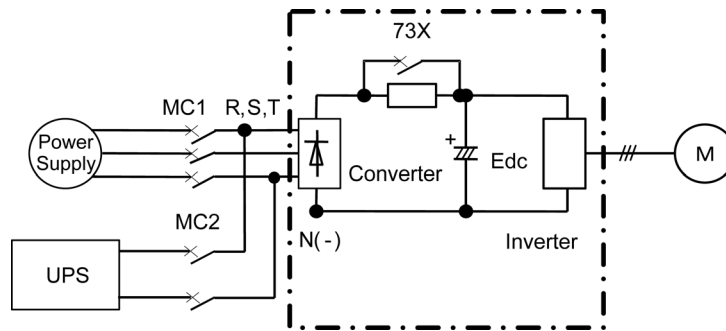

Figure 5.3-5 Connection diagram example
(FRN0115E2■-2□ or below, FRN0085E2■-4□ or below, FRN0012E2■-7□ or below)

UPS operation (When *BATRY/UPS* = ON)

- (1) The inverter can run the motor starting from the voltage level specified with H111.
- (2) The *RDY* ("Inverter ready to run" signal) is forced to go OFF.
- (3) The circuit of charging resistor is shorted (*73X* = ON) after the delay time *T1* (0.2 sec) from the timing which *BATRY/UPS* terminal being turned on and the DC link bus voltage exceeds UPS operation level (specified with H111) or above. In addition, after the delay time *T2* (max. 0.1 sec.), the UPS operation starts. For *T1* specifications, see the table below.
- (4) During the UPS operation, the inverter can run the motor.
- (5) S-curve acceleration/deceleration becomes invalid.

Power supply condition	FRN0115E2■-2□ or below FRN0085E2■-4□ or below FRN0012E2■-7□ or below
Time required for turning on the control power supply, switching to the power supply from the battery, and then to turning on the charging resistor short circuit 73X	T1=0.2 sec
Time required from the occurrence of momentary power failure in the control power supply ON status, switching to the power supply from the battery, and turning on of the short circuit 73X for the charging resistor	

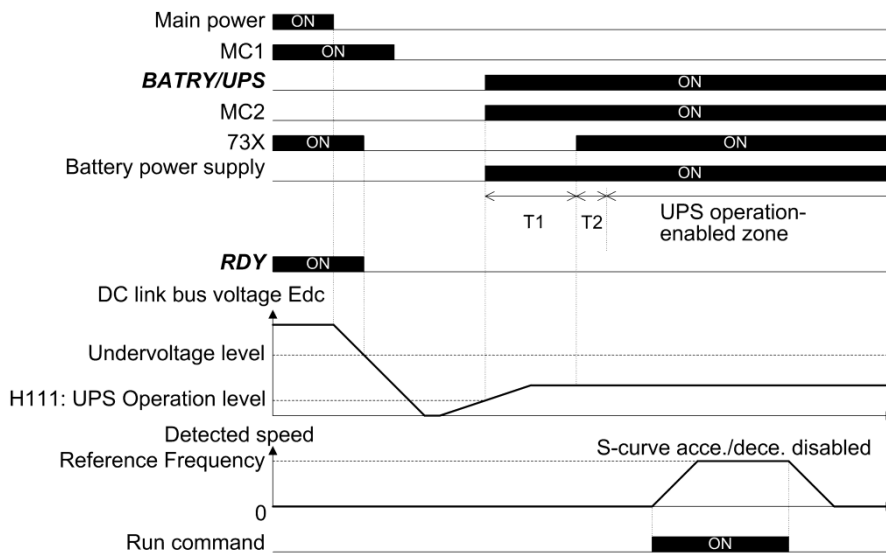

Figure 5.3-6 UPS operation timing chart

■ **Battery operation (Available with FRN0088E2■-2□ or above, FRN0059E2■-4 □ or above)**

When this terminal command is turned on, the undervoltage protection is invalidated. In that case, the motor can be operated by the inverter with undervoltage status by the battery power.

In addition, the main power down detection also becomes invalid regardless of H72 setting.



Prerequisite of battery operation

- (1) Terminal function **BATRY/UPS** (data = 59) can be assigned to any digital input terminal.
- (2) As shown in Figure 5.3-7 and Figure 5.3-8, DC link bus voltage is supplied from the battery to the main circuit (L1/R-L3/T or L2/S-L3/T).
- (3) The specified voltage (sinusoidal waveform or DC voltage) is input to auxiliary power terminal (R0-T0).
- (4) In case of FRN0203E2■-4□ or above, input the specified power supply (sinusoidal waveform) to the fan power supply auxiliary input (R1-T1) as shown in Figure 5.3-9, and change the fan power supply switching connector as shown in Figure 5.3-10 in order to execute the battery operation.
- (5) The terminal that **BATRY/UPS** (data = 59) is assigned has to be turned on simultaneously with the MC2.

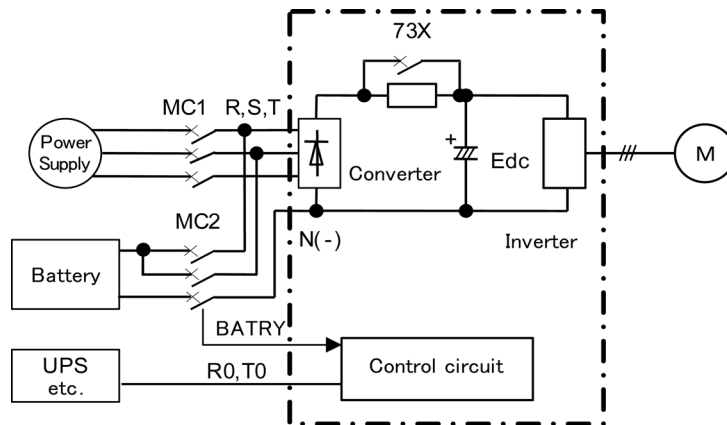

Figure 5.3-7 Connection diagram example (FRN0115E2■-2□ or below, FRN0168E2■-4□ or below)

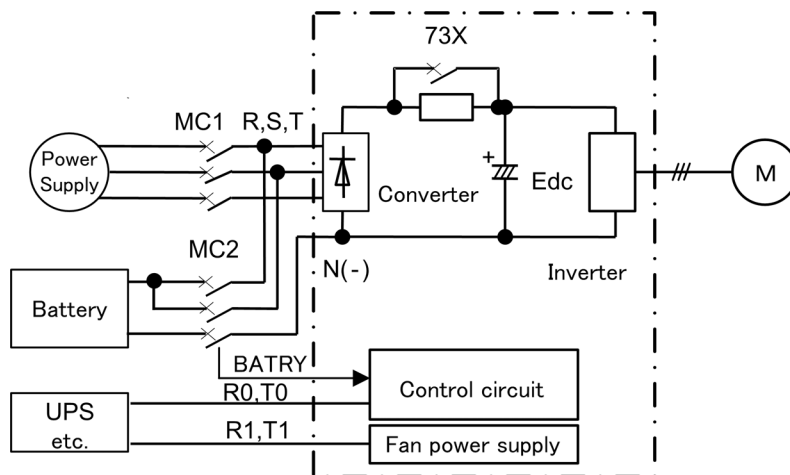

Figure 5.3-8 Connection diagram example (FRN0203E2■-4□ or above)

Setting	CN R (Red) CN W (White)	CN W (White) CN R (Red)
Application	When the terminals R1 and T1 are not used	When the terminal R1, T1 is used (Battery operation)

Figure 5.3-9 Fan power supply switching

Battery operation (When *BATRY/UPS* = ON)

- (1) Undervoltage protection function (*lu*) becomes non-operating status.
- (2) The inverter can operate the motor even under the undervoltage condition.
- (3) Operation ready complete ***RDY*** signal is turned off.
- (4) The circuit of charging resistor is shorted (*73X* = ON) after the delay time *T1* from the ***BATRY/UPS*** terminal being turned on. In addition, after the delay time *T2* (max. 0.1 sec.), the battery operation starts. For *T1* specifications, see Table 5.3-10 on the next page.

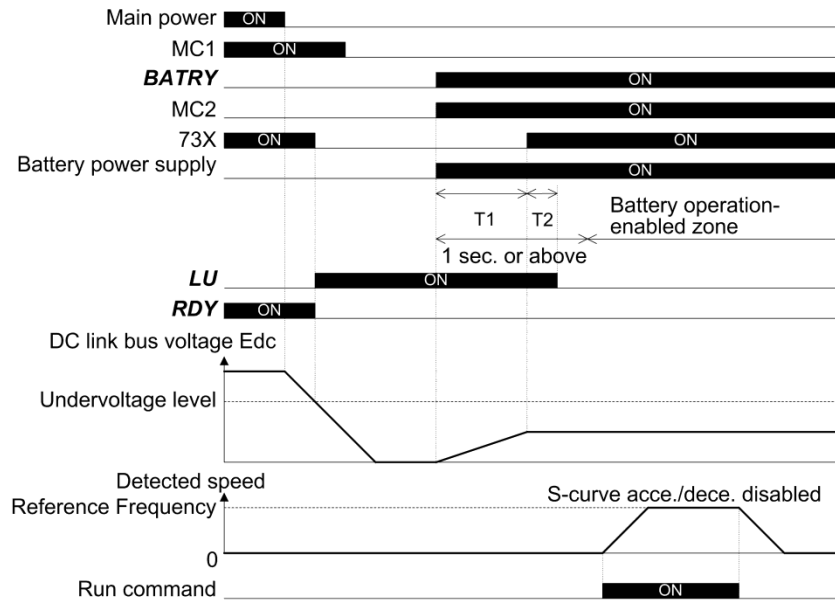

Figure 5.3-10 Battery operation timing chart

Table 5.3-10

Power supply condition	FRN0088E2-2 or above FRN0059E2-4 or above
Time required for turning on the control power supply, switching to the power supply from the battery, and then to turning on the charging resistor short circuit 73X	T1=500 ms
Time required from the occurrence of momentary power failure in the control power supply ON status, switching to the power supply from the battery, and turning on of the short circuit 73X for the charging resistor	

- (5) S-curve acceleration/deceleration becomes invalid.
- (6) The operable speed during the battery operation is calculated by using the following expression.

$$\text{Frequency command} \leq \frac{\text{Battery voltage} - 5[\text{V}]}{\sqrt{2} \times \text{Base voltage}(\text{F05})} \times \text{Base frequency}(\text{F04}) \times k$$

Here,

Battery voltage : 24 VDC or higher (200 V class)
48 VDC or higher (400 V class)

Rated frequency : F04

Rated voltage : F05 (Motor rated voltage (V))

K : Safety factor (Lower than 1 Approx. 0.8)

■ **Select torque bias 1, 2 -- “TB1”, “TB2” (Function code data = 61, 62)**

The combination of the ON/OFF states of digital input signals “TB1” and “TB2” selects one of 3 different level torque-bias commands defined beforehand by 3 function codes H155 to H157 (Torque-bias level 1, level 2 and level 3). Change during drive is invalid. (📖 Function codes H154 to H162)

input signals		Torque-bias to be selected
“TB2”	“TB1”	
OFF	OFF	Disable torque-bias
OFF	ON	H155 Torque-bias level 1
ON	OFF	H156 Torque-bias level 2
ON	ON	H157 Torque-bias level 3

■ **Hold torque bias -- “H-TB” (Function code data = 63)**

Turning this terminal command ON enables a torque-bias hold command. This command directs to preserve the torque-bias data supplied via an analog input. (📖 Function codes H154 to H162)

■ **Check brake – BRKE (Function code data = 65)**

If the status of the brake signal BRKS fails to agree with the status of the brake check signal BRKE during inverter operation, the inverter enters an alarm stop state with $E-rE$.

This signal is used as a feedback signal for the brake signal BRKS. When the mechanical brake does not operate, it causes the inverter to trip to activate the mechanical brake. The response delay time for BRKS and BRKE can be adjusted with H180: Brake response time. (📖 Function codes J68 to J96, H180)

■ **Cancel line speed control -- “Hz/LSC” (Function code data = 70)**

Turning ON Hz/LSC cancels line speed control. This disables the frequency compensation of PI operation, resulting in no compensation for a take-up roll getting bigger and an increase in the winding speed.

Use this signal to temporarily interrupt the control for repairing a thread break, for example. (📖 Function code d41)

“Hz/LSC”	Function
OFF	Enable line speed control (depending on d41 setting)
ON	Cancel line speed control(V/f control, without compensation for a take-up roll getting bigger)

■ **Hold line speed control frequency in the memory -- “LSC-HLD” (Function code data = 71)**

If “LSC/HLD” is ON under line speed control frequency, stopping the inverter (including an occurrence of an alarm and a coast-to-stop command) or turning OFF “Hz/LSC” saves the current frequency command compensating for a take-up roll getting bigger, in the memory. At the time of restart, the saved frequency command applies and the inverter keeps the line speed constant. (📖 Function code d41)

“LSC-HLD”	Function
OFF	Disable (No saving operation)
ON	Enable (Saving the frequency command compensating for a take-up roll getting bigger)

■ **Count the run time of commercial power-driven motor-1 and motor-2 -- “CRUN-M1” and “CRUN-M2” (Function code data = 72, 73)**

These two terminal commands enable the inverter to count the cumulative run time of motor-1 and motor-2 even when they are driven by commercial power (not by the inverter).

When the “CRUN-M1” or “CRUN-M2” is ON, the inverter judges that the motor-1 or motor-2 is driven by commercial power, respectively, and counts the run time of the corresponding motor. (📖 Function codes H44,H94)

■ **Select droop control– “DROOP” (Function code data = 76)**

This terminal command “DROOP” toggles droop control on and off.

Terminal command “DROOP”	Droop control
ON	Enable
OFF	Disable

(📖 Function code H28)

■ **Select speed control parameter 1, 2 -- “MPRM1”, “MPRM2” (Function code data = 78, 79)**

The combination of the ON/OFF states of digital input signals “MPRM1” and “MPRM2” selects one of 4 different level speed control parameter sets for vector control with speed sensor. (📖 Function codes d01 to d08)

■ **Cancel customizable logic – “CLC” (Function code data = 80), Clear all customizable logic timers – “CLTC” (Function code data = 81)**

Terminal command “CLC” stops the operation of customizable logic. Terminal command “CLTC” clears all customizable logic timers. (📖 Function codes U codes)

■ **Cancel anti-regenerative control – “AR-CCL” (Function code data = 82)**

Terminal command “AR-CCL” ON disables anti-regenerative control. (📖 Function code H69)

■ **PID control multistage command 1, 2 – “PID-SS1”, “PID-SS2” (Function code data = 171, 172)**

“PID-SS1” and “PID-SS2” can be used to select 4 different PID commands. (📖 Function codes J136 to J138)

■ **Run forward – “FWD” (Function code data = 98)**

Turning this terminal command ON runs the motor in the forward direction; turning it OFF decelerates it to stop.



This terminal command “FWD” can be assigned only to E98 or E99.

■ **Run reverse – “REV” (Function code data = 99)**

Turning this terminal command “REV” ON runs the motor in the reverse direction; turning it OFF decelerates it to stop.



This terminal command “REV” can be assigned only to E98 or E99.

■ **No function assigned – “NONE” (Function code data = 100)**

It allows the inverter to run unaffected by ON/OFF of signals. It is used when a signal is externally input using customizable logic. It is also used to temporarily disable a terminal function.

E10 to E15

Acceleration time 2 to 4, Deceleration time 2 to 4

(Refer to F07)

Refer to the description of F07.

E16, E17

Torque limiter 2 (driving), 2 (braking)

(Refer to F40)

For the torque limiter 2 (driving) and 2 (braking) settings, refer to the description of F40.

**E20 to E21
E27**

**Terminals [Y1] function to [Y2] function
Terminal [30A/B/C] function (Relay output)**

E20 through E21 and E27 assign output signals to general-purpose, programmable output terminals, [Y1], [Y2] and [30A/B/C]. These function codes can also switch the logic system between normal and negative to define how the inverter interprets the ON or OFF state of each terminal. The factory default setting is normal logic system "Active ON."

Terminals [Y1] and [Y2] are transistor outputs and terminals [30A/B/C] are contact outputs. In normal logic, if an alarm occurs, the relay will be energized so that [30A] and [30C] will be closed, and [30B] and [30C] opened. In negative logic, the relay will be de-energized so that [30A] and [30C] will be opened, and [30B] and [30C] closed. This may be useful for the implementation of failsafe power systems.



- When negative logic is employed, output signal is OFF(active) while the inverter is powered OFF. To avoid causing system malfunctions by this, interlock these signals to keep them ON using an external power supply. Furthermore, the validity of these output signals is not guaranteed for approximately 1.5 seconds (for 22 kW or below) or 3 seconds (for 30 kW or above) after power-ON, so introduce such a mechanism that masks them during the transient period.
- Terminals [30A/B/C] use mechanical contacts. They cannot stand frequent ON/OFF switching. Where frequent ON/OFF switching is anticipated (for example, by using frequency arrival signal), use transistor outputs [Y1] and [Y2] instead.
The service life of a relay is approximately 200,000 times if it is switched ON and OFF at one-second intervals. For signals expected to be turned ON/OFF frequently, use terminals [Y1] and [Y2] for output.

The tables given on the following pages list functions that can be assigned to terminals [Y1], [Y2], and [30A/B/C]. The descriptions are, in principle, arranged in the numerical order of assigned data. However, the signal is related has been described together. Refer to the function codes or signals in the "Related function codes/signals (data)" column, if any.

Explanations of each function are given in normal logic system "Active ON."

Data		Terminal commands assigned	Symbol	Control mode					Related function codes/ Related signals (data)
Active ON	Active OFF			V/f	PG V/f	IM CLV	IM TC	PM SLV	
0	1000	Inverter running	"RUN"	Y	Y	Y	Y	Y	—
1	1001	Frequency (speed) arrival	"FAR"	Y	Y	Y	N	Y	<u>E30</u>
2	1002	Frequency (speed) detected	"FDT"	Y	Y	Y	Y	Y	<u>E31, E32</u>
3	1003	Undervoltage detected (Inverter stopped)	"LU"	Y	Y	Y	Y	Y	—
4	1004	Detected torque polarity	"B/D"	Y	Y	Y	Y	Y	—
5	1005	Inverter output limiting	"IOL"	Y	Y	Y	Y	Y	—
6	1006	Auto-restarting after momentary power failure	"IPF"	Y	Y	Y	Y	Y	<u>F14</u>
7	1007	Motor overload early warning	"OL"	Y	Y	Y	Y	Y	<u>E34, F10, F12</u>
8	1008	Keypad operation enabled	"KP"	Y	Y	Y	Y	Y	—
10	1010	Inverter ready to run	"RDY"	Y	Y	Y	Y	Y	—
15	1015	Switch MC on the input power lines	"AX"	Y	Y	Y	Y	Y	—
16	1016	Pattern operation stage transition	"TU"	Y	Y	Y	N	Y	C21 to C28
17	1017	Pattern operation cycle completed	"TO"	Y	Y	Y	N	Y	
18	1018	Pattern operation stage No. 1	"STG1"	Y	Y	Y	N	Y	
19	1019	Pattern operation stage No. 2	"STG2"	Y	Y	Y	N	Y	
20	1020	Pattern operation stage No. 4	"STG4"	Y	Y	Y	N	Y	
21	1021	Frequency (speed) arrival 2	"FAR2"	Y	Y	Y	N	Y	<u>E29</u>
22	1022	Inverter output limiting (with delay)	"IOL2"	Y	Y	Y	Y	Y	IOL (5)
25	1025	Cooling fan in operation	"FAN"	Y	Y	Y	Y	Y	<u>H06</u>
26	1026	Auto-resetting	"TRY"	Y	Y	Y	Y	Y	<u>H04, H05</u>
27	1027	Universal DO	"U-DO"	Y	Y	Y	Y	Y	—
28	1028	Heat sink overheat early warning	"OH"	Y	Y	Y	Y	Y	—
29	1029	Synchronization completed	"SY"	N	Y	Y	N	N	d71 to d78
30	1030	Lifetime alarm	"LIFE"	Y	Y	Y	Y	Y	<u>H42</u>

5.3 Description of Function Codes

Data		Terminal commands assigned	Symbol	Control mode					Related function codes/ Related signals (data)
Active ON	Active OFF			V/f	PG V/f	IM CLV	IM TC	PM SLV	
31	1031	Frequency (speed) detection 2	"FDT2"	Y	Y	Y	Y	Y	<u>E32</u> , E36
33	1033	Reference loss detected	"REF OFF"	Y	Y	Y	N	Y	<u>E65</u>
35	1035	Inverter outputting	"RUN2"	Y	Y	Y	Y	Y	RUN (0)
36	1036	Overload prevention controlling	"OLP"	Y	Y	Y	N	Y	<u>H70</u>
37	1037	Current detected	"ID"	Y	Y	Y	Y	Y	E34, E35, E37, E38, E55, E56
38	1038	Current detected 2	"ID2"	Y	Y	Y	Y	Y	
39	1039	Current detected 3	"ID3"	Y	Y	Y	Y	Y	
41	1041	Low current detected	"IDL"	Y	Y	Y	Y	Y	
42	1042	PID alarm	"PID-ALM"	Y	Y	Y	N	Y	<u>J11 to J13</u>
43	1043	Under PID control	"PID-CTL"	Y	Y	Y	N	Y	J01
44	1044	Under sleep mode of PID control	"PID-STP"	Y	Y	Y	N	Y	<u>J08</u> , <u>J09</u>
45	1045	Low torque detected	"U-TL"	Y	Y	Y	Y	Y	<u>E78 to E81</u>
46	1046	Torque detected 1	"TD1"	Y	Y	Y	Y	Y	
47	1047	Torque detected 2	"TD2"	Y	Y	Y	Y	Y	
48	1048	Motor 1 selected	"SWM1"	Y	Y	Y	Y	Y	—
49	1049	Motor 2 selected	"SWM2"	Y	Y	Y	Y	Y	
52	1052	Running forward	"FRUN"	Y	Y	Y	Y	Y	—
53	1053	Running reverse	"RRUN"	Y	Y	Y	Y	Y	—
54	1054	Under remote mode	"RMT"	Y	Y	Y	Y	Y	(Refer to Section 3.3.7)
56	1056	Motor overheat detected by thermistor	"THM"	Y	Y	Y	Y	Y	<u>H26</u> , <u>H27</u>
57	1057	Brake control	"BRKS"	Y	Y	Y	N	N	<u>J68 to J72</u>
58	1058	Frequency (speed) detected 3	"FDT3"	Y	Y	Y	Y	Y	<u>E32</u> , E54
59	1059	Terminal [C1] (C1 function)wire break detected	"C1OFF"	Y	Y	Y	Y	Y	—
70	1070	Speed valid	"DNZS"	N	Y	Y	Y	Y	F25, F38
71	1071	Speed agreement	"DSAG"	N	Y	Y	N	Y	d21, d22
72	1072	Frequency (speed) arrival 3	"FAR3"	Y	Y	Y	N	Y	<u>E30</u>
76	1076	PG error detected	"PG-ERR"	N	Y	Y	Y	N	<u>d21 to d23</u>
77	1077	Low DC link bus voltage detection	"U-EDC"	Y	Y	Y	Y	Y	<u>E76</u>
79	1079	During deceleration in momentary power failure	"IPF2"	Y	Y	Y	Y	Y	<u>F14</u> , <u>F15</u>
80	1080	Stop position override alarm	"OT"	N	Y	N	N	N	<u>J73 to J88</u>
81	1081	Under positioning	"TO"	N	Y	N	N	N	
82	1082	Positioning completed	"PSET"	N	Y	Y	N	N	
83	1083	Current position count over-flowed	"POF"	N	Y	N	N	N	
84	1084	Maintenance timer counted up	"MNT"	Y	Y	Y	Y	Y	<u>H44</u> , <u>H78</u> , <u>H79</u>
87	1087	Frequency arrival and frequency detected	"FARFDT"	Y	Y	Y	N	Y	<u>E30</u> , <u>E31</u> , <u>E32</u>
90	1090	Alarm content 1	"AL1"	Y	Y	Y	Y	Y	—
91	1091	Alarm content 2	"AL2"	Y	Y	Y	Y	Y	
92	1092	Alarm content 4	"AL4"	Y	Y	Y	Y	Y	
93	1093	Alarm content 8	"AL8"	Y	Y	Y	Y	Y	
98	1098	Light alarm	"L-ALM"	Y	Y	Y	Y	Y	<u>H81</u> , <u>H82</u>
99	1099	Alarm output (for any alarm)	"ALM"	Y	Y	Y	Y	Y	—
101	1101	EN circuit failure detected	"DECF"	Y	Y	Y	Y	Y	
102	1102	EN terminal input OFF	"ENOFF"	Y	Y	Y	Y	Y	
105	1105	Braking transistor broken	"DBAL"	Y	Y	Y	Y	Y	H98
111	1111	Customizable logic output signal 1	"CLO1"	Y	Y	Y	Y	Y	U71 to U75, U81

Data		Terminal commands assigned	Symbol	Control mode					Related function codes/ Related signals (data) to U90
Active ON	Active OFF			V/f	PG V/f	IM CLV	IM TC	PM SLV	
112	1112	Customizable logic output signal 2	"CLO2"	Y	Y	Y	Y	Y	
113	1113	Customizable logic output signal 3	"CLO3"	Y	Y	Y	Y	Y	
114	1114	Customizable logic output signal 4	"CLO4"	Y	Y	Y	Y	Y	
115	1115	Customizable logic output signal 5	"CLO5"	Y	Y	Y	Y	Y	
116 to 120	1116 to 1120	Customizable logic output signal 6 to 10	"CLO6" to "CLO10"	Y	Y	Y	Y	Y	

Note Any negative logic (Active OFF) command cannot be assigned to the functions marked with "-" in the "Active OFF" column.

■ **Inverter running – “RUN” (Function code data = 0), Inverter outputting – “RUN2” (Function code data = 35)**

These output signals tell the external equipment that the inverter is running at a starting frequency or higher. If assigned in negative logic (Active OFF), these signals can be used to tell the “Inverter being stopped” state.

Output signal	Basic function	Remarks
RUN	These signals come ON when the inverter is running. Under V/f control: These signals come ON if the inverter output frequency exceeds the starting frequency, and go OFF if it drops below the stop frequency. The “RUN” signal can also be used as a “Speed valid” signal.	Goes OFF even during DC braking.
RUN2		Comes ON even during DC braking, pre-excitation, zero speed control.

■ **Frequency (speed) arrival– “FAR” (Function code data = 1), Frequency (speed) arrival 3 – “FAR3” (Function code data = 72)**

These output signals come ON when the difference between the output frequency (detected speed) and reference frequency (reference speed) comes within the frequency arrival hysteresis width specified by E30.

(📖Function code E30)

■ **Frequency (speed) detected – “FDT” (Function code data = 2), Frequency (speed) detected 2 – “FDT2” (Function code data = 31), Frequency (speed) detected 3 – “FDT3” (Function code data = 58)**

These output signals FDT, FDT2 or FDT3 come ON when the output frequency (detected speed) exceeds the frequency detection level specified by E31, E36 or E54, respectively, and go OFF when the output frequency (detected speed) drops below the “Frequency detection level (E31, E36 or E54) - Hysteresis width (E32).”

(📖 Function codes E31 and E32)

■ **Undervoltage detected (Inverter stopped) – “LU” (Function code data = 3)**

This output signal comes ON when the DC link bus voltage of the inverter drops below the specified undervoltage level. When this signal is ON, the inverter cannot run even if a run command is given. It goes OFF when the voltage exceeds the level.

■ **Detected torque polarity – “B/D” (Function code data = 4)**

The inverter issues the driving or braking polarity signal to this digital output judging from the internally calculated torque or torque command. This signal goes OFF when the detected torque corresponds to driving, and it goes ON when it corresponds to braking.

■ **Inverter output limiting – “IOL” (Function code data = 5), Inverter output limiting with delay – “IOL2” (Function code data = 22)**

The output signal IOL comes ON when the inverter is limiting the output frequency by activating any of the following actions (minimum width of the output signal: 100 ms). The output signal IOL2 comes ON when any of the following output limiting operation continues for 20 ms or more.

- Torque limiting (F40, F41, E16 and E17, Maximum internal value)
- Current limiting by software (F43 and F44)
- Instantaneous overcurrent limiting by hardware (H12 = 1)
- Automatic deceleration (Anti-regenerative control) (H69)

Note When the “IOL” is ON, it may mean that the output frequency may have deviated from the reference frequency because of the limiting functions above.

■ **Auto-restarting after momentary power failure – “IPF” (Function code data = 6)**

This output signal is ON either during continuous running after a momentary power failure or during the period after the inverter detects an undervoltage condition and shuts down the output until restart has been completed (the output has reached the reference frequency). (📖 Function code F14)

■ **Motor overload early warning – “OL” (Function code data = 7)**

The OL signal is used to detect a symptom of an overload condition (alarm code \overline{OL} / \overline{I}) of the motor so that the user can take an appropriate action before the alarm actually happens. (📖 Function code E34)

■ **Keypad operation enabled – “KP” (Function code data = 8)**

This output signal comes ON when the  /  keys are specified as the run command source.

■ **Inverter ready to run – “RDY” (Function code data = 10)**

This output signal comes ON when the inverter becomes ready to run by completing hardware preparation (such as initial charging of DC link bus capacitors and initialization of the control circuit) and no protective functions are activated.

■ **Switch MC on the input power lines – “AX” (Function code data = 15)**

In response to a run command FWD, this output signal controls the magnetic contactor on the commercial-power supply side. It comes ON when the inverter receives a run command. It goes OFF after the motor decelerates to stop with a stop command received. This signal immediately goes OFF upon receipt of a coast-to-stop command or when an alarm occurs.

“AX” can be selected where there is control power such as with FRN0088E2■-2□ or above, FRN0059E2■-4□ or above.

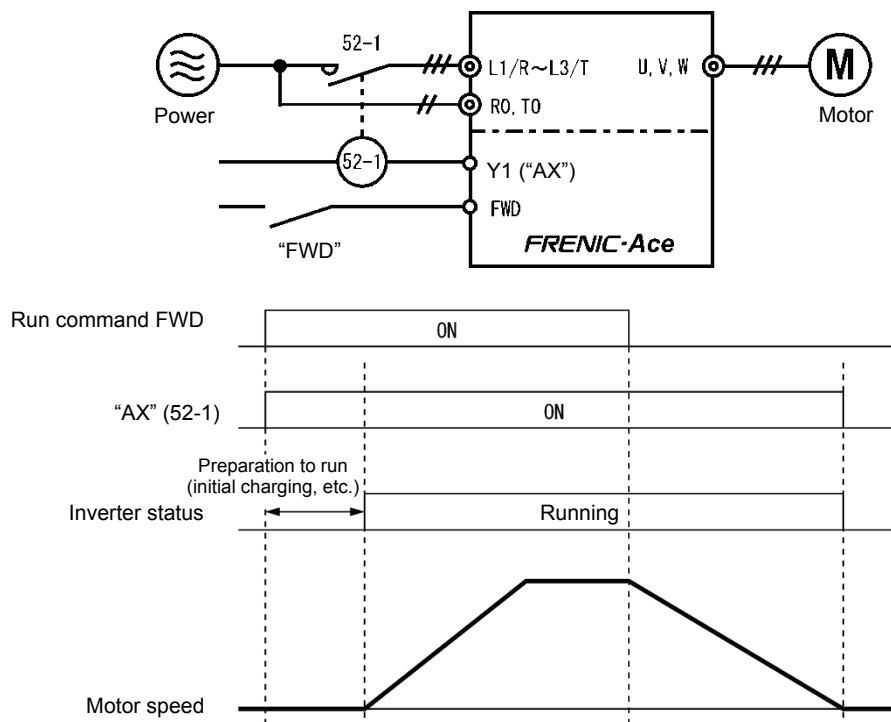

■ **Pattern operation stage No. 1 – “STG1” (Function code data = 18), Pattern operation stage No. 2 – “STG2” (Function code data = 19), Pattern operation stage No. 4 – “STG4” (Function code data = 20)**

Outputs the stage (operation process) currently performed during pattern operation.

Operation pattern stage No.	Output terminal signal		
	STG1	STG2	STG4
Stage 1	ON	OFF	OFF
Stage 2	OFF	ON	OFF
Stage 3	ON	ON	OFF
Stage 4	OFF	OFF	ON
Stage 5	ON	OFF	ON
Stage 6	OFF	ON	ON
Stage 7	ON	ON	ON

■ **Frequency (speed) arrival 2 – “FAR2” (Function code data = 21)**

The signals come ON when the difference between the output frequency before torque limiting and reference frequency is within the frequency arrival hysteresis width specified by E30 and the frequency arrival delay specified by E29 has elapsed. (📖 Function codes E29 and E30)

■ **Cooling fan in operation – “FAN” (Function code data = 25)**

With the cooling fan ON/OFF control enabled (H06 = 1), this output signal is ON when the cooling fan is in operation, and OFF when it is stopped. This signal can be used to make the cooling system of peripheral equipment interlocked for an ON/OFF control. (📖 Function code H06)

■ **Auto-resetting – “TRY” (Function code data = 26)**

This output signal comes ON when auto resetting (resetting alarms automatically) is in progress.

(📖 Function codes H04 and H05)

■ **Universal DO -- “U-DO” (Function code data = 27)**

Assigning this output signal to an inverter's output terminal and connecting the terminal to a digital input terminal of peripheral equipment, allows an upper controller to send commands to the peripheral equipment via the RS-485 or the fieldbus communications link. The universal DO can be used as an output signal independent of the inverter operation.

📖 For the procedure for access to Universal DO via the RS-485 or fieldbus communications link, refer to the respective instruction manual.

■ **Heat sink overheat early warning – “OH” (Function code data = 28)**

This output signal is used to issue a heat sink overheat early warning that enables you to take a corrective action before an overheat trip \overline{OH} actually happens.

ON at [(Overheat trip (\overline{OH}) temperature) – 5°C (41°F)] or higher

OFF at [(Overheat trip (\overline{OH}) temperature) - 8°C (46°F)] or lower

This signal comes ON also when the internal air circulation DC fan (FRN0203 E2■-4□ or above for 400 V class series) is locked.

■ **Synchronization completed -- “SY” (Function code data = 29)**

This output signal comes ON when the control target comes inside the synchronization completion detection angle in synchronous running.

For details about master-follower operation, refer to function codes J73 to J88.

■ **Lifetime alarm – “LIFE” (Function code data = 30)**

This output signal comes ON when it is judged that the service life of any one of capacitors (DC link bus capacitors or electrolytic capacitors on the printed circuit boards) or cooling fan has expired. This signal should be used as a guide for replacement of the capacitors and cooling fan. If this signal comes ON, use the specified maintenance procedure to check the service life of these parts and determine whether the parts should be replaced or not.

( Function code H42)

This signal comes ON also when the internal air circulation DC fan (FRN0203 E2■-4□ or above for 400 V class series) is locked.

■ **Reference loss detected – “REF OFF” (Function code data = 33)**

This output signal comes ON when an analog input used as a frequency command source is in a reference loss state (as specified by E65) due to a wire break or a weak connection. This signal goes OFF when the normal operation under the analog input is resumed. ( Function code E65)

■ **Overload prevention controlling – “OLP” (Function code data = 36)**

This output signal comes ON when overload prevention control is activated. (The minimum ON-duration is 100 ms.) ( Function code H70)

■ **Current detected – “ID” (Function code data = 37), Current detected 2 – “ID2” (Function code data = 38), Current detected 3 – “ID3” (Function code data = 39)**

When the inverter output current exceeds the level specified by E34, E37 or E55 for the period specified by E35, E38 or E56, the ID, ID2 or ID3 signal turns ON, respectively. (The minimum ON-duration is 100 ms.)

( Function code E34)

■ **Low current detected – “IDL” (Function code data = 41)**

When the inverter output current falls to or below the level specified by E34, E37 or E55 for the period specified by E35, E38 or E56, the ID, ID2 or ID3 signal turns ON, respectively. (The minimum ON-duration is 100 ms.)

( Function code E34)

■ **PID alarm – “PID-ALM” (Function code data = 42)**

Assigning this output signal enables PID control to output absolute-value alarm or deviation alarm.

( Function codes J11 to J13)

■ **Under PID control – “PID-CTL” (Function code data = 43)**

This output signal comes ON when PID control is enabled (“Cancel PID control” (Hz/PID) = OFF) and a run command is ON. ( Function code J01)



When PID control is enabled, the inverter may stop due to the slow flowrate stopping function or other reasons. If that happens, the “PID-CTL” signal remains ON. As long as the “PID-CTL” signal is ON, PID control is effective, so the inverter may abruptly resume its operation, depending on the feedback value in PID control.

WARNING

When PID control is enabled, even if the inverter stops its output during operation because of sensor signals or other reasons, operation will resume automatically. Design your machinery so that safety is ensured even in such cases.

Otherwise an accident could occur.

■ **Under sleep mode of PID control – “PID-STP” (Function code data = 44)**

This output signal is ON when the inverter is in a stopped state due to the slow flowrate stopping function under PID control.) ( Function codes J15 to J17, J23 J24)

■ **Low torque detected – “U-TL” (Function code data = 45)**

This output signal comes ON when the torque value calculated by the inverter or torque command drops below the level specified by E80 (Low torque detection (Level)) for the period specified by E81 (Low torque detection (Timer)). (minimum width of the output signal: 100 ms) ( Function codes E78 to E81)

■ **Frequency arrival AND frequency detected – “FARFDT” (Function code data = 87)**

The FARFDT, which is an ANDed signal of FAR and FDT, comes ON when both signal conditions are met.
 (📖 Function codes E30 to E32)

■ **Torque detected 1 – “TD1” (Function code data = 46), Torque detected 2 – “TD2” (Function code data = 47)**

This output signal TD1 or TD2 comes ON when the torque value calculated by the inverter or torque command exceeds the level specified by E78 or E80 (Torque detection (Level)) for the period specified by E79 or E81 (Torque detection (Timer)), respectively. (minimum width of the output signal: 100 ms)
 (📖 Function codes E78 to E81)

■ **Motor 1, and 2 selected – “SWM1” and “SWM2” (Function code data = 48 and 49)**

The output signal “SWM1” or “SWM2” comes ON corresponding to the motor selected by the signal “M2” or the selected function code group. (📖 Function code A42)

■ **Running forward – “FRUN” (Function code data = 52) Running reverse – “RRUN” (Function code data = 53)**

Output signal	Assigned data	Running forward	Running reverse	Inverter stopped
“FRUN”	52	ON	OFF	OFF
“RRUN”	53	OFF	ON	OFF

■ **Under remote mode – “RMT” (Function code data = 54)**

This output signal comes ON when the inverter switches from local to remote mode.

(📖 For details of switching between remote and local modes, refer to Chapter 3 “3.3.7 Remote and local modes.”)

■ **Motor overheat detected by thermistor – “THM” (Function code data = 56)**

When the PTC thermistor on the motor detects an overheat, the inverter turns this signal ON and continues to run, without entering the alarm \square state. This feature applies only when H26 data is set to “2.”

(📖 Function codes H26 and H27)

■ **Brake control – “BRKS” (Function code data = 57)**

This signal outputs a brake control command that releases or applies the brake. (📖 Function codes J68 to J72)

■ **Terminal [C1] (C1 function) wire break detected – “C1OFF” (Function code data = 59)**

This output signal comes ON when the inverter detects that the input current to terminal [C1] (C1 function) drops below 2 mA interpreting it as the terminal [C1] wire broken.

■ **Speed valid -- “DNZS” (Function code data = 70)**

This output signal comes ON when the reference speed or detected one exceeds the stop frequency specified by function code F25. It goes OFF when the speed is below the stop frequency for 100 ms or longer.

Under vector control with speed sensor, F38 switches the decision criterion between the reference speed and actual speed. Under vector control without speed sensor, the reference speed is used as a decision criterion.

(📖 Function codes F25 and F38.)

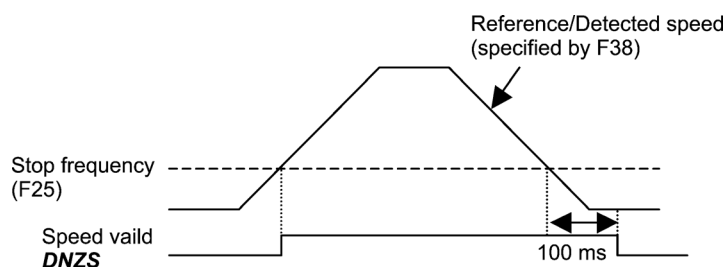

■ **Speed agreement -- “DSAG” (Function code data = 71)**

This output signal comes ON when the deviation of the detected speed from the speed command after the acceleration/deceleration processor is within the allowable range specified by d21. It goes OFF when the deviation is beyond the range for longer than the period specified by d22. This feature allows you to check whether the speed controller is working correctly.

 Function codes d21 and d22.

■ **PG error detected -- “PG-ERR” (Function code data = 76)**

This output signal comes ON when the inverter detects a PG error with the d23 (PG error processing) data being set to “0: Continue to run,” in which the inverter does not enter the alarm state.

 Function codes d21 through d23.

■ **Low DC link bus voltage detection -- “U-EDC” (Function code data = 77)**

This output signal comes ON when the DC intermediate voltage drops below E76 (DC link bus low-voltage detection level), and it goes OFF when the DC intermediate voltage exceeds E76. ( Function code E76)

■ **During decelerating at momentary power failure -- “IPF2” (Function code data = 79)**

When F14 data is set to 2 or 3, this output signal comes ON when the DC intermediate voltage drops below H15 (Continue to run level) and continue to run control starts. When the power returns and the DC intermediate voltage becomes “at least 10 V higher than the voltage specified by H15,” the signal goes OFF.

Even when F14 data is set to 4 or 5, the signal comes ON when the DC intermediate voltage drops below the undervoltage level, and it goes OFF when the DC intermediate voltage becomes “at least 10 V higher than the undervoltage level.” ( Function codes F14 and H15)

■ **The positioning control signals -- “OT”, “TO” and “POF” (Function code data = 80, 81, 83)**

These signals are used to the positioning control function. ( Function codes J73 to J88)

■ **Positioning completed -- “PSET” (Function code data = 82)**

This output signal comes ON as a positioning completion signal. This signal is used to the servolock function and the positioning control function.

( Function codes to J97 to J99 for the servo lock function, function codes J73 to J88 for the positioning control function)

■ **Maintenance timer counted up -- “MNT” (Function code data = 84)**

Once the inverter’s cumulative run time or the startup times for the motor 1 exceeds the previously specified count, this output signal comes ON. ( Function codes H78 and H79)

■ **Alarm content – “AL1”, “AL2”, “AL4”, “AL8” (Function code data = 90, 91, 92, 93)**

Outputs the state of operation of the inverter protective functions.

Alarm content (inverter protective function)	Alarm code	Output terminal			
		AL1	AL2	AL4	AL8
Instantaneous overcurrent protection, earth fault protection, fuse blown	<i>OC1 OC2 OC3 EF FUS</i>	ON	OFF	OFF	OFF
Oversvoltage protection	<i>OU1 OU2 OU3</i>	OFF	ON	OFF	OFF
Undervoltage protection, input phase loss	<i>LU L_{in}</i>	ON	ON	OFF	OFF
Motor overload, electronic thermal (motors 1 to 4)	<i>OL1 OL2 OL3 OL4</i>	OFF	OFF	ON	OFF
Inverter overload	<i>OLU</i>	ON	OFF	ON	OFF
INV overheat protection, inverter internal overheat, charging resistor overheat	<i>OH1 OH3 OH6</i>	OFF	ON	ON	OFF
External alarm, DB resistor overheat, motor overheat	<i>OH2 dbH OH4</i>	ON	ON	ON	OFF
Memory error, CPU error, undervoltage save error, hardware combination error	<i>Er1 Er3 ErF ErH</i>	OFF	OFF	OFF	ON
Keypad communications error, option communications error	<i>Er2 Er4</i>	ON	OFF	OFF	ON
Option error	<i>Er5 Er_t</i>	OFF	ON	OFF	ON
Charging circuit error, operating procedure error, EN circuit error, DB transistor failure detection	<i>PbF Er6 ECF dbA</i>	ON	ON	OFF	ON
Tuning error, output phase loss protection	<i>Er7 OPL</i>	OFF	OFF	ON	ON
RS485 communications error	<i>Er8 ErP</i>	ON	OFF	ON	ON
Overspeed protection, PG error, excessive positioning error Speed mismatch (excessive speed deviation), positioning control error	<i>OS PG ErE Er_o</i>	OFF	ON	ON	ON
PID feedback wire break, mock alarm Other alarm	<i>COF Err</i>	ON	ON	ON	ON

*No terminal outputs a signal during normal operation.

■ **Light alarm – “L-ALM” (Function code data = 98)**

This output signal comes ON when a light alarm occurs. (📖 Function codes H81 and H82)

■ **Alarm output (for any alarm) – “ALM” (Function code data = 99)**

This output signal comes ON if any of the protective functions is activated and the inverter enters Alarm mode.

■ **EN circuit failure detected – “DECF” (Function code data = 101)**

The signal comes ON when any error is detected in the circuit for EN terminal.

■ **EN terminal input OFF – “ENOFF” (Function code data = 102)**

The signal comes ON when the EN terminal is turned OFF.

■ **Braking transistor broken – “DBAL” (Function code data = 105)**

If the inverter detects a breakdown of the braking transistor, it displays the braking transistor alarm ($dbtF$) and also issues the output signal “DBAL”. Detection of the breakdown of a braking transistor can be canceled by H98. (FRN0072E2■-4□ or below, FRN0115E2■-2□ or below, FRN0012E2■-7□ or below) (📖 Function code H98)



A breakdown of the braking transistor could lead to a damage of the braking resistor or inverter’s internal units. To prevent the secondary damage, use “DBAL” to cut off power to the magnetic contactor in inverter primary circuits upon detection of a breakdown of the built-in braking transistor.

■ **Customizable logic output signal 1 to 10 – “CLO1” to “CLO10” (Function code data =111 to 120)**

Outputs the result of customizable logic operation. (📖 Function codes U codes)

E29 E30	Frequency arrival delay timer (FAR2) Frequency arrival detection width (Detection width)
------------	---

E30 specifies the detection level for the Frequency (speed) arrival signal “FAR”, Frequency (speed) arrival signal 2 “FAR2” and the Frequency (speed) arrival signal 3 “FAR3”.

Output signal	E20, E21, E27 assigned data	Operating condition 1	Operating condition 2
“FAR”	1	The signals come ON when the difference between the output frequency (estimated/actual speed) and the reference frequency (reference speed) comes within the frequency arrival width specified by E30.	FAR always goes OFF when the run command is OFF or the reference speed is “0.”
“FAR3”	72		When the run command is OFF, the inverter regards the reference speed as “0,” so FAR3 comes ON as long as the output frequency (estimated/actual speed) is within the range of “0 ± the frequency arrival width specified by E30.”
“FAR2”	21	The signal comes ON when the difference between the output frequency (before torque and current limiting) and the reference frequency (reference speed) comes within the frequency arrival width specified by E30.	This signal always goes OFF when the run command is OFF or the reference speed is “0.” The delay can be specified by E29.

- Data setting range: E30: 0.0 to 10.0 (Hz), E29: 0.01 to 10.00 (s)

The operation timings of each signal are as shown below.

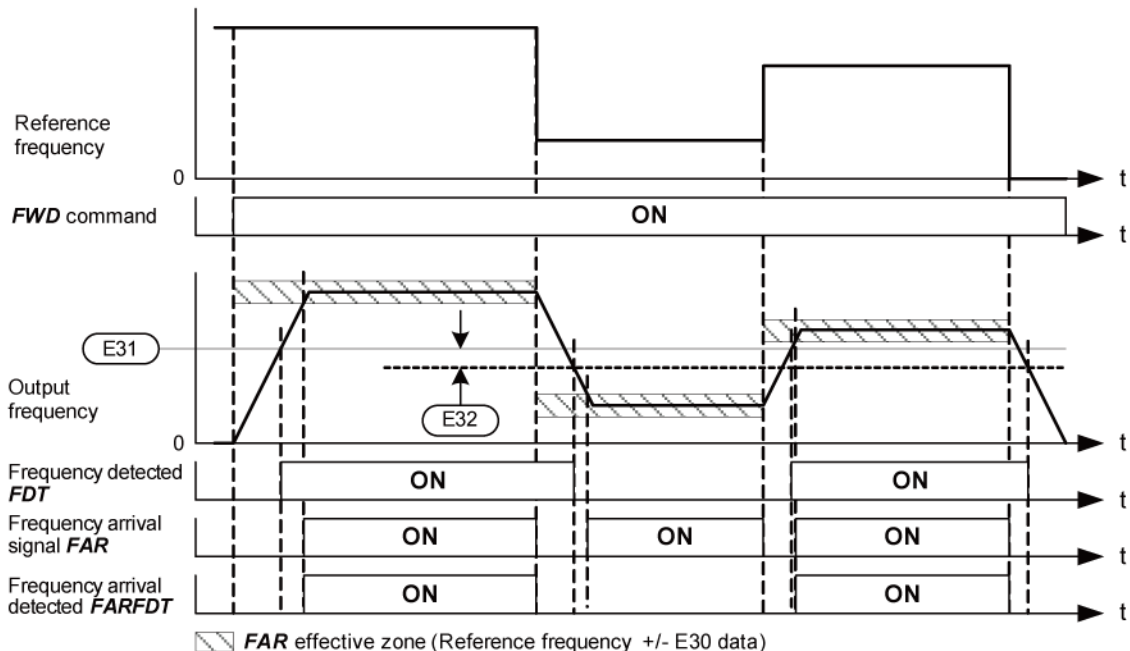
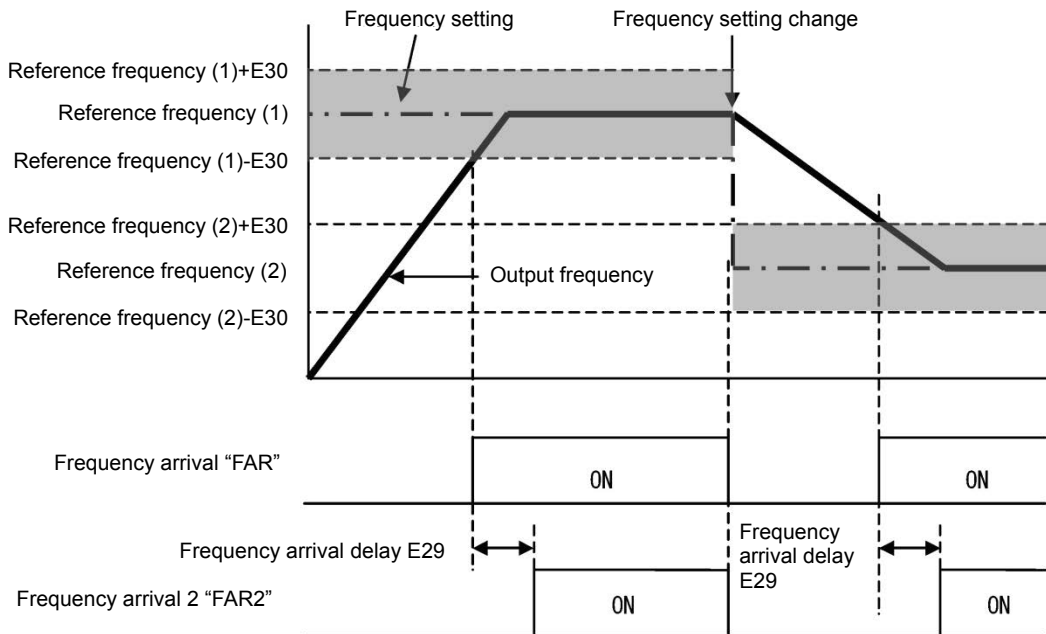
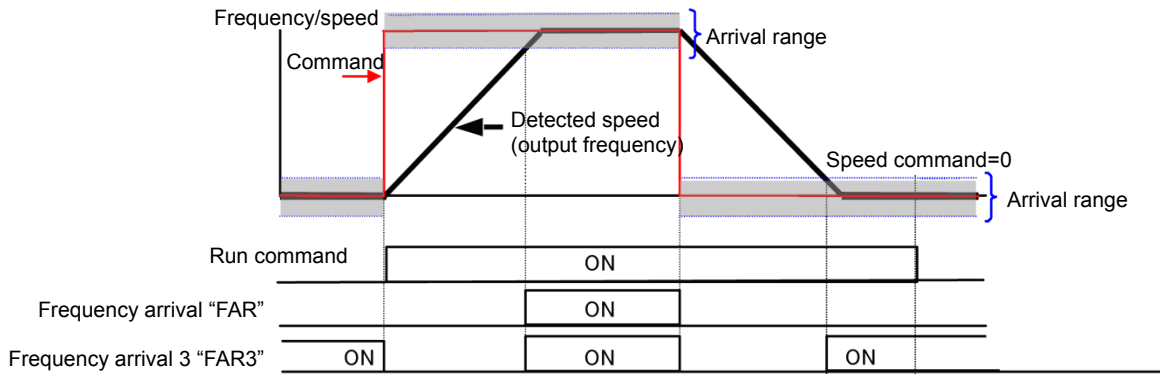

E31, E32	Frequency detection (level and hysteresis width) Related function codes: E36 (Frequency detection 2, level), E54 (Frequency detection 3, level)
-----------------	--

When the output frequency exceeds the frequency detection level specified by E31, the “Frequency (speed) detection signal” comes ON; when it drops below the “Frequency detection level minus Hysteresis width specified by E32,” it goes OFF.

The following three settings are available.

Name	Output signal	E20,E21, E27 Assigned data	Operation level	Hysteresis width
			Range: 0.0 to 500.0Hz	Range: 0.0 to 500.0Hz
Frequency detection	“FDT”	2	E31	E32
Frequency detection 2 (level)	“FDT2”	31	E36	
Frequency detection 3 (level)	“FDT3”	58	E54	

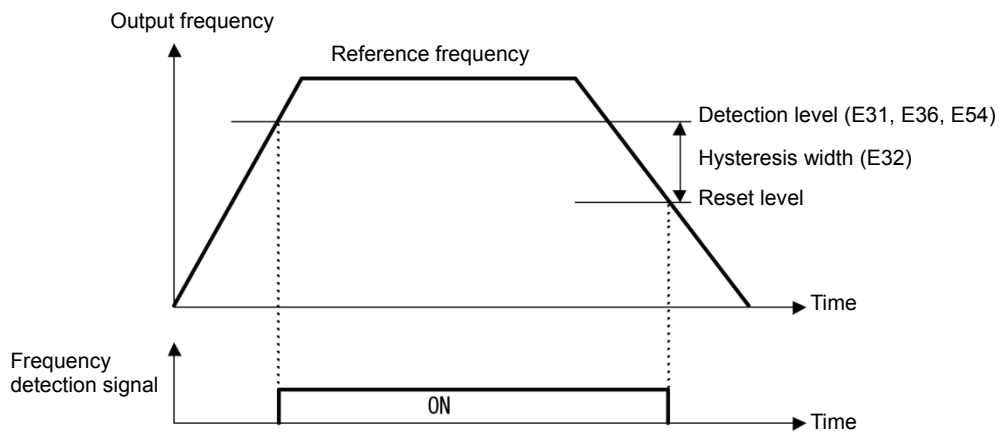

E34, E35	Overload early warning/Current detection (level and timer) Related function codes: E37, E38 (Current detection 2/Low current detection level and timer) E55, E56 (Current detection 3, level and timer)
-----------------	--

These function codes define the detection level and time for the Motor overload early warning “OL”, Current detected “ID”, Current detected 2 “ID2”, Current detected 3 “ID3”, and Low current detected “IDL” output signals.

Output signal	E20,E21, E27 Assigned data	Detection level	Timer	Motor characteristics	Thermal time constant
		Range: See below	Range: 0.01 to 600.00 s	Range: See below	Range: 0.5 to 75.0 min
“OL”	7	E34	—	F10	F12
“ID2”	37	E34	E35	—	—
“ID2”	38	E37	E38		
“ID3”	39	E55	E56		
“IDL”	41	E37	E38		

- Data setting range
 - Detection level: 0.00 (Disable), 1 to 200% of inverter rated current
 - Motor characteristics 1: Enable (For a general-purpose motor with shaft-driven cooling fan)
 - 2: Enable (For an inverter-driven motor, non-ventilated motor, or motor with separately powered cooling fan)

■ **Motor overload early warning signal – “OL”**

The OL signal is used to detect a symptom of an overload condition (alarm code \overline{OL} / \overline{I}) of the motor so that the user can take an appropriate action before the alarm actually happens. The OL signal turns ON when the inverter output current exceeds the level specified by E34. In typical cases, set E34 data to 80 to 90% against F11 data (Electronic thermal overload protection for motor 1, Overload detection level). Set the temperature characteristics of the motor with electronic thermal (motor characteristics selection, thermal time constant).

■ **Current detected, Current detected 2 and Current detected 3 – “ID”, “ID2” and “ID3”**

When the inverter output current exceeds the level specified by E34, E37 or E55 for the period specified by E35, E38 or E56, the ID, ID2 or ID3 signal turns ON, respectively. When the output current drops below 90% of the specified detection level, the ID, ID2 or ID3 turns OFF. (The minimum ON-duration is 100 ms.)

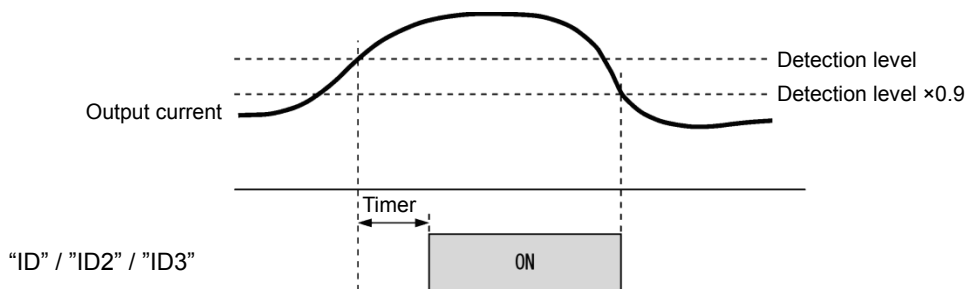

■ Low current detected – “IDL”

This signal turns ON when the output current drops below the level specified by E37 (Low current detection, Level) for the period specified by E38 (Timer). When the output current exceeds the “Low current detection level plus 5% of the inverter rated current,” it goes OFF. (The minimum ON-duration is 100 ms.)

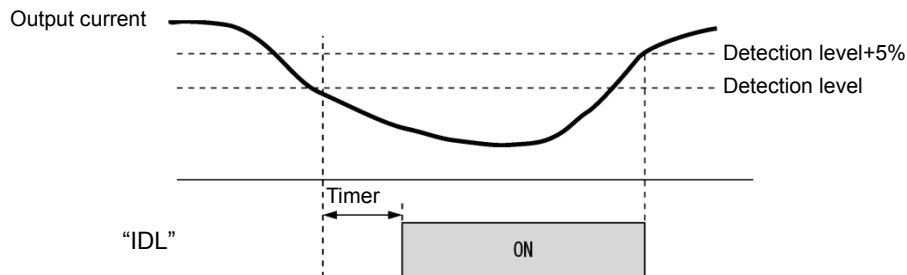
**E36****Frequency detection 2****(refer to E31)**

Refer to the description of E31.

E37, E38**Current detection 2/Low current detection (level and timer)****(refer to E34)**

For details about Current detection 2/Low current detection (level) (timer), refer to the description of E34.

E39**Display coefficient for transport time****Related function code: E50 (Display coefficient for speed monitor)**

E39 specifies the constant-rate feeding time, load shaft speed, coefficient for line speed setting, and coefficient for output status monitor indication.

Formula

$$\text{Constant rate (min)} = \frac{\text{Display coefficient for speed monitor (E50)}}{\text{Display coefficient for transport time (E39)}}$$

$$\text{Load shaft speed} = (\text{E50: Display coefficient for transport time}) \times \text{Frequency (Hz)}$$

$$\text{Line speed} = (\text{E50: Display coefficient for transport time}) \times \text{Frequency (Hz)}$$

The “Frequency” in the above formula is set frequency when each indication is the setting value (constant-rate feeding time setting, load shaft speed setting, and line speed setting), whereas it is output frequency before slip compensation when the indication is output status monitor.

When the constant-rate feeding time is 999.9 (min) or greater, or the denominator on the above formula is 0, “999.9” is displayed.

E42**LED display filter**

Excluding speed monitor (when E43 = 0), E42 specifies a filter time constant to be applied for displaying the output frequency, output current and other running status monitored on the LED monitor on the keypad. If the display varies unstably so as to be hard to read due to load fluctuation or other causes, increase this filter time constant.

- Data setting range: 0.0 to 5.0 (s)

E43	LED monitor (Item selection) Related function code: E48 LED monitor (speed monitor item)
------------	---

E43 specifies the running status item to be monitored and displayed on the LED monitor. Specifying the speed monitor with E43 provides a choice of speed-monitoring formats selectable with E48 (LED monitor).

Monitor item	Display sample on the LED monitor	LED indication	Unit	Meaning of displayed value	E43 data
Speed monitor	Function code E48 specifies what to be displayed on the LED monitor and LED indicators.				0
Output frequency 1 (before slip compensation)	50.00	■Hz□A□kW	Hz	Indicated value = Output frequency (Hz)	(E48 = 0)
Output frequency 2 (after slip compensation)	50.00	■Hz□A□kW	Hz	Indicated value = Output frequency (Hz)	(E48 = 1)
Reference frequency	50.00	■Hz□A□kW	Hz	Indicated value = Reference frequency (Hz)	(E48 = 2)
Motor rotation speed	1500	■Hz■A□kW	min ⁻¹	Indicated value = Output frequency (Hz) × $\frac{120}{P01}$	(E48 = 3)
Load rotation speed	300.0	■Hz■A□kW	min ⁻¹	Indicated value = Output frequency (Hz) × E50	(E48 = 4)
Line speed	300.0	□Hz■A■kW	m/min	Indicated value = Output frequency (Hz) × E50	(E48 = 5)
Transport time for specified length	50.00	□Hz□A□kW	min	Indicated value = E50/(Output frequency × E39)	(E48 = 6)
Speed (%)	50.0	□Hz□A□kW	%	Indicated value = $\frac{\text{Output frequency (Hz)}}{\text{Maximum frequency}} \times 100$	(E48 = 7)
Output current	12.34	□Hz■A□kW	A	Current output from the inverter in RMS	3
Output voltage	200.0	□Hz□A□kW	V	Output voltage (RMS) of the inverter	4
Calculated torque	50	□Hz□A□kW	%	Motor output torque in % (Calculated value)	8
Input power	10.25	□Hz□A■kW	kW	Input power to the inverter	9
PID process command	10.00	□Hz□A□kW	-	PID command and its feedback converted into physical quantities of the object to be controlled (e.g. temperature)	10
PID feedback value	9.00	□Hz□A□kW	-		12
Timer value	100	□Hz□A□kW	s	Timer value (remaining run time)	13
PID output	100.0	□Hz□A□kW	%	PID output in % as the maximum frequency (F03) being at 100%	14
Load factor	50	□Hz□A□kW	%	Load factor of the motor in % as the rated output being at 100%	15
Motor output	9.85	□Hz□A■kW	kW	Motor output in kW	16
Analog signal input monitor	82.00	□Hz□A□kW	-	An analog input to the inverter in a format suitable for a desired scale.	17
Current position pulse	1234	□Hz□A□kW	pulse	The current position pulse	21
Position error pulse	2345	□Hz□A□kW	pulse	The current position deviation pulse.	22
Torque current	48	□Hz□A□kW	%	Torque current command value or calculated torque current	23
Magnetic flux command	50	□Hz□A□kW	%	Magnetic flux command value (Available only under vector control)	24
Input watt-hour	100.0	□Hz□A□kW	kWh	Indicated value = $\frac{\text{Input watt - hour (kWh)}}{100}$	25

■ Illuminated, □ Not illuminated

E44	LED monitor (display when stopped)
------------	---

E44 specifies whether the specified value (data = 0) or the output value (data = 1) will be displayed on the LED monitor of the keypad when the inverter is stopped. The monitored item depends on the E48 (LED monitor, Speed monitor item) setting as shown below.

E48 data	Monitored item	Inverter stopped	
		E44 = 0 Specified value	E44 = 1 Output value
0	Output frequency 1 (before slip compensation)	Reference frequency	Output frequency 1 (before slip compensation)
1	Output frequency 2 (after slip compensation)	Reference frequency	Output frequency 2 (after slip compensation)
2	Reference frequency	Reference frequency	Reference frequency
3	Motor rotation speed	Reference motor rotation speed	Motor rotation speed
4	Load rotation speed	Reference load rotation speed	Load rotation speed
5	Line speed	Reference line speed	Line speed
6	Transport time for specified length	Transport time for specified length setting	Transport time for specified length
7	Speed (%)	Reference display speed	Display Speed

E48	LED monitor (speed monitor item)		(refer to E43)
------------	---	--	-----------------------

For details about LED Monitor (Speed monitor item), refer to the description of E43.

E49	Torque Command Monitor (Polarity selection)
------------	--

The polarity of calculated torque value in v/f control or the torque command value in vector control is normally + for driving and – for braking. However in the case of hoisting load, when the motor rotation direction changes from forward direction to reverse direction, the torque polarity also changes from driving to braking. If it monitors the torque data by FRENIC-Loader, we cannot take the expected data around zero speed because the polarity changes. If E49 is set to 0, the torque monitor data becomes + for forward/driving and reverse/braking, - for forward/braking and reverse/driving. Therefore we can monitor the continuous torque data around zero speed.

E49 data	Torque monitor polarity
0	Torque polarity (+ for forward/driving and reverse braking, - for forward/braking and reverse/driving)
1 (Factory setting)	Plus for driving, Minus for braking

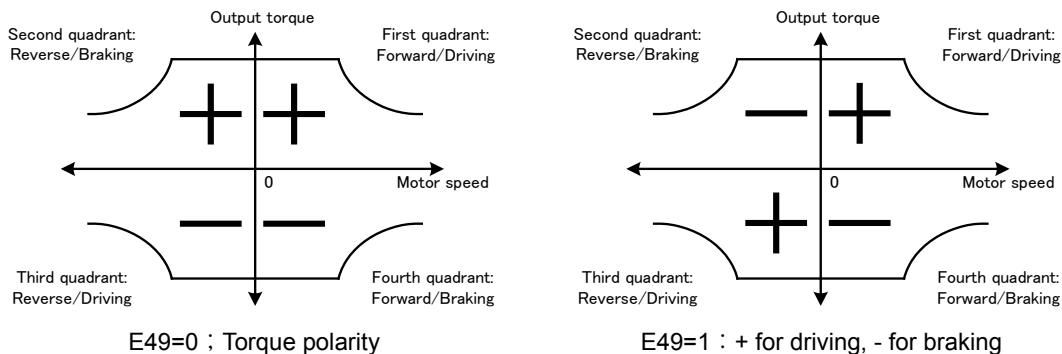

Related data is the following. These data are displayed and submitted with polarity. Judge the meaning of the polarity by E49 setting.

Torque data	Data	Related data
Keypad LED monitor	E43=8	Calculated torque
	E43=23	Torque current
Keypad drive monitor	3.04	Calculated torque
Keypad alarm information	5.03	Calculated torque when alarm
OPC-AIO	o90 = 4	Output torque (only o93=0:Bipolar)
Torque monitor function code	M02	Torque direction
	M03	Torque current direction
	M07	Output torque
	M08	Torque current
	M28	Torque direction when alarm
	M29	Torque current direction when alarm
	M33	Output torque when alarm
	M34	Torque current when alarm
	W07	Calculated torque
	W24	Torque current
	X23	Calculated torque when alarm
	X63	Calculated torque when alarm
	Z03	Calculated torque when alarm
	Z53	Calculated torque when alarm
Z81	Output torque	

E50**Display coefficient for speed monitor**

E50 specifies the coefficient that is used when the load shaft speed or line speed is displayed on the LED monitor. (Refer to the description of E43.)

Load shaft speed [min^{-1}] = (E50: Display coefficient for speed monitor) × (Output frequency Hz)

Line speed [m/min] = (E50: Display coefficient for speed monitor) × (Output frequency Hz)

- Data setting range: 0.01 to 200.00

E51**Display coefficient for "Input watt-hour data"**

E51 specifies a display coefficient (multiplication factor) for displaying the input watt-hour data (5.03) in a part of maintenance information on the keypad.

Input watt-hour data = Display coefficient (E51 data) × Input watt-hour (100kWh)

- Data setting range: 0.000 (cancel/reset) 0.001 to 9999



Setting E51 data to 0.000 clears the input watt-hour and its data to "0." After clearing, be sure to restore E51 data to the previous value; otherwise, input watt-hour data will not be accumulated.

E52	Keypad (Menu display mode)
------------	-----------------------------------

E52 provides a choice of three menu display modes for the standard keypad as listed below.

E52 data	Menu display mode	Menus to be displayed
0	Function code data editing mode	Menus #0, #1 and #7
1	Function code data check mode	Menus #2 and #7
2	Full-menu mode	Menus #0 through #7

E52 specifies the menus to be displayed on the standard keypad. There are eight menus as shown in the table below.

Menu #	LED monitor shows:	Function	Display content
0	<i>0. Fnc</i>	Quick setup	Quick setup function code
1	<i>1. F_o</i>	Data setting F to o	F to o group function code
2	<i>2. rEP</i>	Data check	Modified function code
3	<i>3. oPE</i>	Operation monitor	Operation status indication
4	<i>4. I_o</i>	I/O check	DIO, AIO status indication
5	<i>5. CHE</i>	Maintenance	Maintenance information indication
6	<i>6. AL</i>	Alarm information	Alarm information indication
7	<i>7. CPY</i>	Data copy	Data copy function (only optional keypad)
8	<i>8. dES</i>	Destinations	Destinations setting

 For details of each menu item, refer to Chapter 3 “OPERATION USING THE KEYPAD.”

E54	Frequency detection 3 (level)	(refer to E31)
------------	--------------------------------------	-----------------------

For details, refer to the description of E31.

E55, E56	Current detection 3 (level and timer)	(refer to E34)
-----------------	--	-----------------------

For details, refer to the description of E34.

E59**Terminal [C1] function selection (C1 function//V2 function)**

Specifies whether terminal [C1] is used with current input +4 to +20 mA/0 to 20 mA or voltage input 0 to +10 V. In addition, switch SW7 on the interface board must be switched.

E59 data	Input form	Switch SW7
0	Current input: 4 to 20 mA/0 to 20 mA (C1 function)	C1
1	Voltage input: 0 to 10 V (V2 function)	V2



When using terminal [C1] as a PTC thermistor input, specify E59 = 0.

For using terminal [C1] for the C1, V2 or PTC function, switching as shown below is necessary.

Terminal [C1]	SW3	SW4	E59	H26	C40
For use of C1 function (4 to 20 mA)	C1	AI	0	0	0,10
For use of C1 function (0 to 20 mA)	C1	AI	0	0	1, 11
For use of V2 function (0 to +10 V)	V2	AI	1	0	Does not matter
For use of PTC function	C1	PTC	Does not matter	1,2	Does not matter



For details about SW3 and SW4, refer to Chapter 2, Section 2.2.8.

⚠ WARNING

Failure to correctly switch as shown above may cause a wrong analog input value, possibly leading to unexpected operation of the inverter.

Injuries may occur.

Failure may occur.

E61 to E63	Terminals [12], [C1] (C1 function), [C1] (V2 function) (extended function)
-------------------	---



Select the functions of terminals [12], [C1] (C1 function) and [C1] (V2 function).





There is no need to set up these terminals if they are to be used for frequency command sources.

E61, E62, E63 data	Function	Description
0	None	—
1	Auxiliary frequency command 1	Auxiliary frequency input to be added to the reference frequency given by frequency setting 1 (F01). Will not be added to any other reference frequency given by frequency setting 2 and multistep frequency commands, etc. 100%/full scale
2	Auxiliary frequency command 2	Auxiliary frequency input to be added to all frequency commands. Will be added to frequency command 1, frequency command 2, multistep frequency commands, etc. 100%/full scale
3	PID process command	Inputs command sources such as temperature and pressure under PID control. You also need to set function code J02. 100%/full scale
5	PID feedback value	Inputs feedback values such as temperature and pressure under PID control. 100%/full scale
6	Ratio setting	Multiplies the final frequency command value by this value, for use in the constant line speed control by calculating the winder diameter or in ratio operation with multiple inverters. 100%/full scale
7	Analog torque limiter A	Used when analog inputs are used as torque limiters. (📖 Function code F40) 200%/full scale
8	Analog torque limiter B	Used when analog inputs are used as torque limiters. (📖 Function code F40) 200%/full scale
9	Torque bias	Used when analog inputs are used as torque bias. (📖 Function code H154) 200%/full scale
10	Torque command	Analog inputs to be used as torque commands under torque control. (📖 Function code H18 (Torque control).)
11	Torque current command	Analog inputs to be used as torque current commands under torque control. (📖 Function code H18 (Torque control).)
17	Speed limit for forward rotation	Analog inputs to be used as speed limit FWD under torque control. (📖 Function code H18 (Torque control).)
18	Speed limit for reverse rotation	Analog inputs to be used as speed limit REV under torque control. (📖 Function code H18 (Torque control).)
20	Analog signal input monitor	By inputting analog signals from various sensors such as the temperature sensors in air conditioners to the inverter, you can monitor the state of external devices via the communications link. By using an appropriate display coefficient, you can also have various values to be converted into physical quantities such as temperature and pressure before they are displayed. 100%/full scale

 If these terminals have been set up to have the same data, E61 is given priority. For E62 and E63, only the terminal selected with E59 is enabled.

E64	Saving of digital reference frequency
------------	--

E64 specifies how to save the reference frequency specified in digital format by the   keys on the keypad as shown below.

E64 data	Function
0	The reference frequency will be automatically saved when the main power is turned OFF. At the next power-on, the reference frequency at the time of the previous power-off applies.
1	Saving by pressing  key. Pressing the  key saves the reference frequency. If the control power is turned OFF without pressing the  key, the data will be lost. At the next power-ON, the inverter uses the reference frequency saved the  key was pressed.

E65**Reference loss detection (continuous running frequency)**

When the analog frequency command (setting through terminal [12], [C1] (C1 function) or [C1] (V2 function) has dropped below 10% of the reference frequency within 400 ms, the inverter presumes that the analog frequency command wire has been broken and continues its operation at the frequency determined by the ratio specified by E65 to the reference frequency. And “REF OFF” signal comes on.

(📖 Function codes E20, E21 and E27, data = 33)

When the frequency command level (in voltage or current) returns to a level higher than that specified by E65, the inverter presumes that the broken wire has been fixed and continues to run following the frequency command.

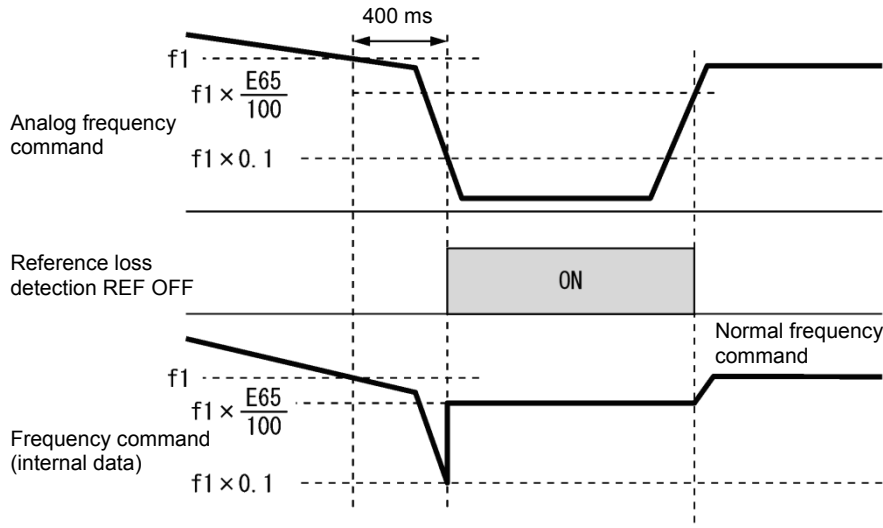

In the diagram above, f_1 is the level of the analog frequency command sampled at any given time. The sampling is repeated at regular intervals to continually monitor the wiring connection of the analog frequency command.

- Data setting range: 0 (Decelerate to stop) 20 to 120 % 999 (Disable)



Note Avoid an abrupt voltage or current change for the analog frequency command. An abrupt change may be interpreted as a wire break.

Setting E65 data at “999” (Disable) allows the REF OFF signal (“Reference loss detected”) to be issued, but does not allow the reference frequency to change. (The inverter runs at the analog frequency command as specified.)

When E65 = “0” or “999,” the reference frequency level at which the broken wire is recognized as fixed is “ $f_1 \times 0.2$.”

When E65 = “100” (%) or higher, the reference frequency level at which the wire is recognized as fixed is “ $f_1 \times 1$.”

The reference loss detection is not affected by the setting of analog input adjustment (filter time constants: C33, C38, and C43).

E76**DC link bus low-voltage detection level**

“U-EDC” signal comes ON when the DC intermediate voltage drops below E76 (DC link bus low-voltage detection level), and it goes OFF when the DC intermediate voltage exceeds E76.

(📖 Function codes E20, E21 and E27, data = 77)

E78, E79 E80, E81	Torque detection 1 (level and timer) Torque detection 2/low torque detection (level and timer)
----------------------	---

E78 specifies the operation level and E79 specifies the timer, for the output signal “TD1”. E80 specifies the operation level and E81 specifies the timer, for the output signal “TD2” or “U-TL”.

In the inverter’s low frequency operation, as a substantial error in torque calculation occurs, no low torque can be detected within the operation range at less than 20% of the base frequency (F04). (In this case, the result of recognition before entering this operation range is retained.) The U-TL signal goes off when the inverter is stopped.

Since the motor parameters are used in the calculation of torque, it is recommended that auto-tuning be applied by function code P04 to achieve higher accuracy.

Output signal	Assigned data	Detection level	Timer
		Range: 0 to 300%	Range: 0.01 to 600.00 s
“TD1”	46	E78	E79
“TD2”	47	E80	E81
“U-TL”	45	E80	E81

■ Torque detected 1 – “TD1”, Torque detected 2 – “TD2”

The output signal TD1 or TD2 comes ON when the torque value calculated by the inverter or torque command exceeds the level specified by E78 or E80 (Torque detection (Level)) for the period specified by E79 or E81 (Torque detection (Timer)), respectively. The signal turns OFF when the calculated torque drops below “the level specified by E78 or E80 minus 5% of the motor rated torque.” (The minimum ON-duration is 100 ms.)

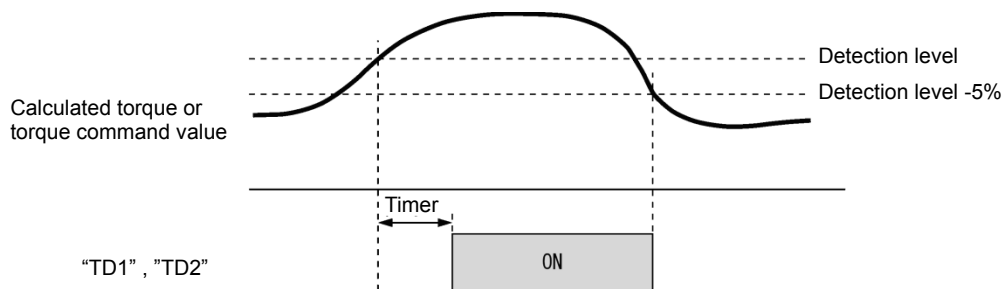

■ Low torque detected – “U-TL”

This output signal comes ON when the torque value calculated by the inverter or torque command drops below the level specified by E80 (Low torque detection (Level)) for the period specified by E81 (Low torque detection (Timer)). The signal turns OFF when the calculated torque exceeds “the level specified by E78 or E80 plus 5% of the motor rated torque.” (The minimum ON-duration is 100 ms.)

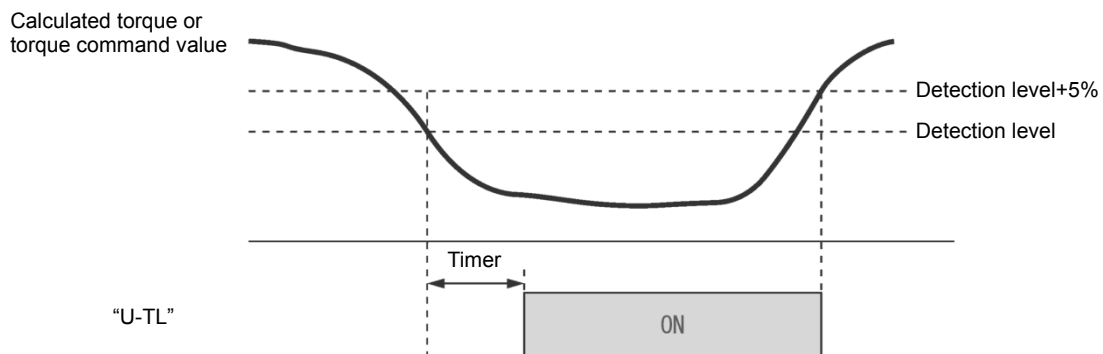

E98, E99	Terminal [FWD] function, Terminal [REV] function (refer to E01 to E05)
----------	--

For details, refer to the descriptions of E01 to E05.

5.3.3 C codes (Control functions)

C01 to C04

Jump frequency 1, 2 and 3, Jump frequency (Skip width)

These function codes enable the inverter to jump over three different points on the output frequency in order to skip resonance caused by the motor speed and natural frequency of the driven machinery (load).

- While increasing the reference frequency, the moment the reference frequency reaches the bottom of the jump frequency band, the inverter keeps the output at that bottom frequency. When the reference frequency exceeds the upper limit of the jump frequency band, the internal reference frequency takes on the value of the reference frequency. When decreasing the reference frequency, the situation will be reversed. Refer to the left figure below.
- When more than two jump frequency bands overlap, the inverter actually takes the lowest frequency within the overlapped bands as the bottom frequency and the highest as the upper limit. Refer to the right figure below.

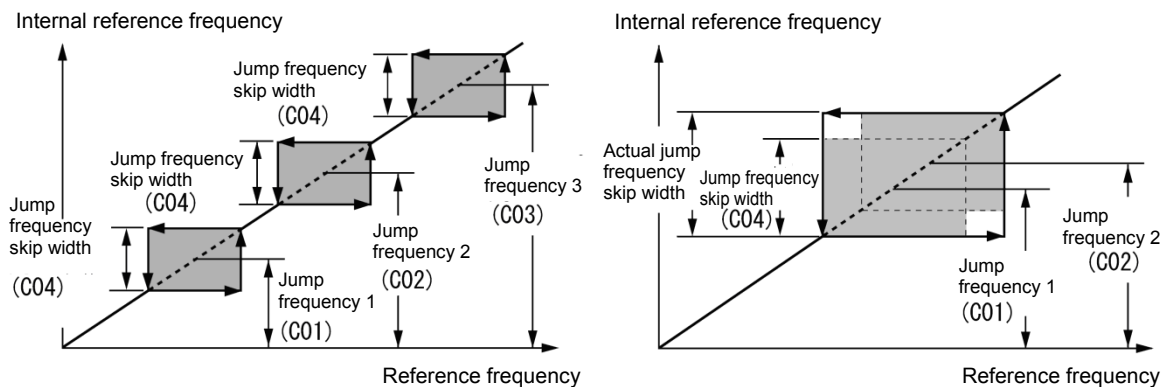

■ Jump frequency 1, 2 and 3 (C01, C02 and C03)

Specify the center of the jump frequency band.

- Data setting range: 0.0 to 500.0 (Hz) (Setting to 0.0 results in no jump frequency band.)

■ Jump frequency skip width (C04)

Specify the jump frequency skip width.

- Data setting range: 0.0 to 30.0 (Hz) (Setting to 0.0 results in no jump frequency band.)

C05 to C19**Multistep frequency 1 to 15**

■ **These function codes specify 15 frequencies required for driving the motor at frequencies 1 to 15.**

Turning terminal commands “SS1”, “SS2”, “SS4” and “SS8” ON/OFF selectively switches the reference frequency of the inverter in 15 steps. To use this features, you need to assign “SS1”, “SS2”, “SS4” and “SS8” (“Select multistep frequency”) to the digital input terminals with E01 to E05 (data = 0, 1, 2, and 3).

■ **Multistep frequency 1 to 15 (C05 through C19)**

- Data setting range: 0.00 to 500.0 (Hz)

The combination of “SS1”, “SS2”, “SS4” and “SS8” and the selected frequencies is as follows.

“SS8”	“SS4”	“SS2”	“SS1”	Selected frequency command
OFF	OFF	OFF	OFF	Other than multistep frequency*
OFF	OFF	OFF	ON	C05 (Multistep frequency 1)
OFF	OFF	ON	OFF	C06 (Multistep frequency 2)
OFF	OFF	ON	ON	C07 (Multistep frequency 3)
OFF	ON	OFF	OFF	C08 (Multistep frequency 4)
OFF	ON	OFF	ON	C09 (Multistep frequency 5)
OFF	ON	ON	OFF	C10 (Multistep frequency 6)
OFF	ON	ON	ON	C11 (Multistep frequency 7)
ON	OFF	OFF	OFF	C12 (Multistep frequency 8)
ON	OFF	OFF	ON	C13 (Multistep frequency 9)
ON	OFF	ON	OFF	C14 (Multistep frequency 10)
ON	OFF	ON	ON	C15 (Multistep frequency 11)
ON	ON	OFF	OFF	C16 (Multistep frequency 12)
ON	ON	OFF	ON	C17 (Multistep frequency 13)
ON	ON	ON	OFF	C18 (Multistep frequency 14)
ON	ON	ON	ON	C19 (Multistep frequency 15)

* “Other than multistep frequency” includes frequency setting 1 (F01), frequency setting 2 (C30) and other frequency command sources except multistep frequency commands.

C20**Jogging frequency**

**Related function codes: H54 and H55 Acceleration/Deceleration time (Jogging)
H54 and H55 Acceleration/Deceleration time (jogging)**

C20 specifies the operating condition (frequency) to apply in jogging operation.

Function code	Data setting range	Description
C20 Jogging frequency	0.00 to 500.00 (Hz)	Reference frequency for jogging operation
H54 Acceleration time (Jogging)	0.00 to 6000 s	Acceleration time for jogging operation
H55 Deceleration time (Jogging)	0.00 to 6000 s	Deceleration time for jogging operation



For details about jogging operation, refer to Chapter 3 “3.3.6 Jogging operation.”

C21 C22 to C28	Pattern operation mode selection Stage 1 to 7 / Timed operation
---------------------------	--

Pattern operation is a function of automatic operation according to the predefined run time, rotational direction, acceleration/deceleration time and reference frequency.

When using this function, set the frequency setting (F01) to 10 (pattern operation).

The following operation patterns are available:

C21:Setting	Operation pattern
0	Pattern operation performed for one cycle and stopped after the cycle.
1	Pattern operation repeatedly performed and immediately stopped with a stop command
2	Pattern operation performed for one cycle and operation continued at the reference frequency after the cycle.
3	Timed operation

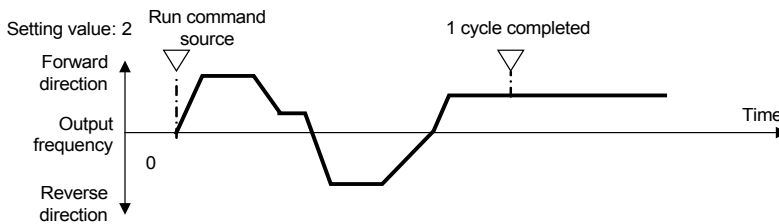
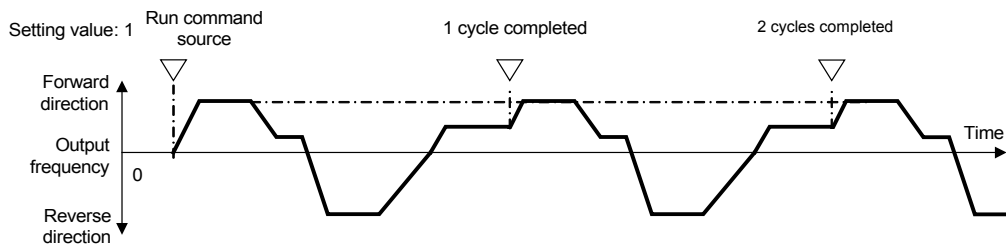
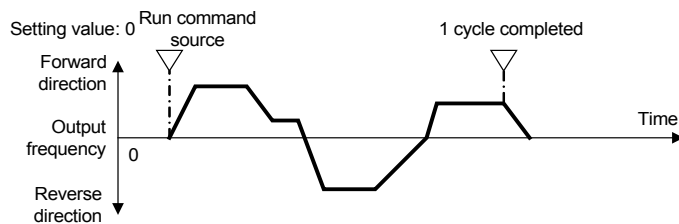

■ **C22 to C28 Stage 1 to Stage 7**

Specify the run time for Stage 1 to Stage 7.

Press the key three times for each function code to set the following three data.

Setting	Description
1st	Specifies the run time between 0.0 and 6000 s.
2nd	2nd: Specifies the rotational direction F (forward) or r (reverse)
3rd	3rd: Specifies the acceleration/deceleration time between 1 and 4. 1: F07/F08 2: E10/E11 3: E12/E13 4: E14/E15

If the key is pressed to exit the function code before the three data are specified by pressing the key three times, no data are updated.

For any unused stage, specify 0.0 as the run time. The stage is skipped and the next stage becomes ready for setting.

■ Reference frequency

Multistep frequencies 1 to 7 are assigned to the reference frequency of Stage 1 to 7.

■ Example of pattern operation setting

C21 (Mode selection)	Stage No.	Run time	Rotational direction	Acceleration/deceleration time Setting value	Operation (reference) frequency
		Setting value	Setting value		
0	Stage 1	60.0	F	2	C05 Multistep frequency 1
	Stage 2	100	F	1	C06 Multistep frequency 2
	Stage 3	65.5	r	4	C07 Multistep frequency 3
	Stage 4	55.0	r	3	C08 Multistep frequency 4
	Stage 5	50.0	F	2	C09 Multistep frequency 5
	Stage 6	72.0	F	4	C10 Multistep frequency 6
	Stage 7	35.0	F	2	C11 Multistep frequency 7

The figure below illustrates the operation.

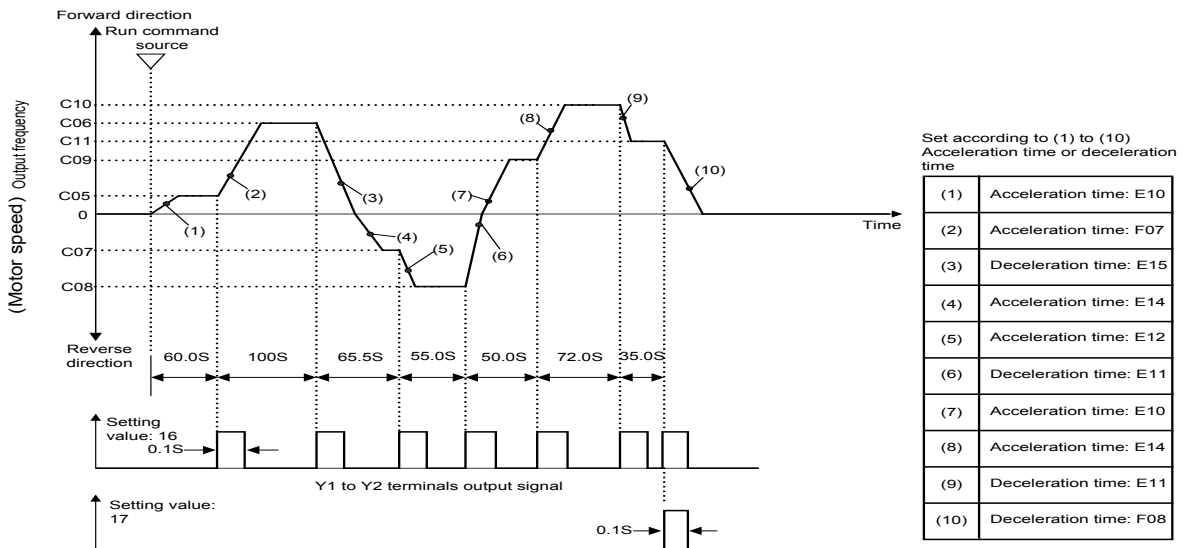

F08 Deceleration time 1 setting is used as deceleration time for deceleration to stop after the completion of one cycle.

- ◆ To run or stop, use input from the **RUN** key of the keypad or by switching the control terminal. When using the keypad, press the **RUN** key to run. Press the **STOP** key to suspend the progression of stages. Press the **RUN** key again to resume operation according to the stages from the point where it was suspended. For alarm stop, press the **PRG/RES** key to reset the inverter protective functions. Then press the **RUN** key. The suspended progression of the cycle resumes. If a need arises for operation from the first stage “C22 (Stage 1 runtime)” and “C82 (Stage 1 rotational direction and acceleration/deceleration time)” during operation, input a stop command and press the **PRG/RES** key.

When operation from the first stage is necessary after an alarm stop, press the **PRG/RES** key for resetting the protective functions and press the **PRG/RES** key again. For operation with input terminals, use of the “RST” terminal (set “8 (Active ON)” or “1008 (Active OFF)”) for any of E01 to E05) function the same way.

- Tip • Pattern operation can be started by either a forward run command (specify F02 = 2 and press the **RUN** key, or specify F02 = 1 and turn the FWD terminal ON) or reverse run command (specify F02 = 3 and press the **RUN** key, or specify F02 = 1 and turn the REV terminal ON). However, the rotational direction is as specified by C82 to C88 regardless the operation is started by a forward run command or reverse run command.
- If using FWD or REV terminal, please use the alternate-type switch because it is not self-holding.



⚠ CAUTION

When pattern operation is started by specifying C21 = 0 and turning the FWD (REV) terminal ON, the motor stops after the completion of the last stage even if the FWD (REV) terminal is kept turned ON. In this case, modifying the value for F01 or C30 or switching the control terminal "Hz2/Hz1" ON/OFF without turning the FWD (REV) terminal OFF causes the operation to be immediately resumed according to the reference frequency after the change.

An accident or physical injury may result.

■ Timed operation (C21 = 3)

Select this for timed operation, in which simply specifying the run time and inputting a run command starts motor operation and stops the operation after the specified period has elapsed.



- Tip**
- To stop the timed operation, press the  key during timer countdown.
 - When the timer period is 0, pressing the  key does not start operation if C21 = 3.
 - An external signal (FWD or REV) can also be used to start operation.

Example of timed operation

Preconfiguration

- To indicate the timer value on the LED monitor, set the data for E43 (LED monitor) to "13" (timer value) and data for C21 to "3."
- Specify the reference frequency for timed operation. When the reference frequency is specified by keypad operation and the timer value is indicated, press the  key to switch to speed monitor display and modify the reference frequency.

Timed operation (to start operation with the  key)

- (1) While checking the timer value on the LED monitor, press the  key to specify the timer period (in seconds). (The timer value is indicated as an integer without a decimal point on the LED monitor.)
- (2) Press the  key to start motor operation. The timer period counts down. After the timer period has elapsed, the operation stops without the need for pressing the  key. (Timed operation is possible even when the LED monitor indication is not the timer value.)

Note For operation by turning the FWD terminal ON, the indication alternates between "end" and LED monitor display (0 for timer value) when the timed operation has been completed with deceleration to stop. Turning FWD OFF brings back the LED monitor display.

C30	Frequency setting 2	(refer to F01)
------------	----------------------------	-----------------------

For details of frequency setting 2, refer to the description of F01.

C31 to C35	Analog input adjustment (terminal [12]) (offset, gain, filter time constant, gain base point, polarity)
C36 to C40	Analog input adjustment (terminal [C1] C1 function) (offset, gain, filter time constant, gain base point, range/polarity)
C41 to C45	Analog input adjustment (terminal [C1] V2 function) (offset, gain, filter time constant, gain base point, polarity) (refer to F01 for frequency setting)
C55, C56	Bias (for PID, frequency command 2 (terminal [12])) (bias, bias base point) (refer to F01)
C61, C62	Bias (for PID, frequency command 2 (terminal [C1]) (C1 function)) (bias, bias base point)(refer to F01)
C67, C68	Bias (for PID, frequency command 2 (terminal [C1]) (V2 function)) (bias, bias base point)(refer to F01)

You can adjust the gain, bias, polarity, filter time constant and offset which are applied to analog inputs (voltage inputs to terminals [12] and [C1] (V2 function) and current input to terminal [C1] (C1 function)).

Adjustable items for analog inputs (excluding those for frequency command 1)

Input terminal	Input range	Bias		Gain		Polarity	Filter time constant	Offset
		Bias	Base point	Gain	Base point			
[12]	0 to +10 V, -10 to +10 V	C55	C56	C32	C34	C35	C33	C31
[C1] (C1)	4 to 20 mA, 0 to 20 mA	C61	C62	C37	C39	C40	C38	C36
[C1] (V2)	0 to +10 V	C67	C68	C42	C44	C45	C43	C41

■ Offset (C31, C36, C41)

C31, C36 or C41 configures an offset for an analog voltage/current input.

- Data setting range: -5.0 to +5.0 (%)

■ Filter time constant (C33, C38, C43)

C33, C38, and C43 provide the filter time constants for the voltage and current of the analog input. The larger the time constant, the slower the response. Specify the proper filter time constant taking into account the response speed of the machine (load). If the input voltage fluctuates due to line noises, increase the time constant.

- Data setting range: 0.00 to 5.00 (s)

■ Polarity Terminal [12] (C35)

C35 and C45 configure the input range for analog input voltage.

C35 data	Modes for terminal inputs
0	-10 to +10 V
1	0 to +10 V (negative value of voltage is regarded as 0 V)

■ Polarity [C1] (V2 function) (C45)

C45 data	Modes for terminal inputs
0	0 to +10 V When the bias is specified to be a negative value, makes a point lower than 0 effective as a negative value.
1	0 to +10 V (factory default) When the bias is specified to be a negative value, limits a point lower than 0 to 0.

■ Gain

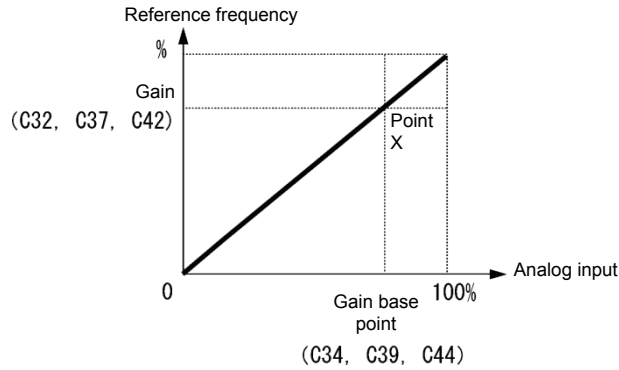

Note To input bipolar analog voltage (0 to ±10 VDC) to terminal [12], set C35 data to “0.” Setting C35 data to “1” enables only the voltage range from 0 to +10 VDC and interprets the negative polarity input from 0 to -10 VDC as 0 V.

■ Terminal [C1] (C1 function) range / polarity selection(C40)

Selects the range of current input terminal [C1](C1 function).

C40 data	Terminal input range	When specified bias is negative
0	4 to 20 mA (factory default)	Limits a point lower than 0 to 0.
1	0 to 20 mA	
10	4 to 20 mA	Makes a point lower than 0 effective as a negative value.
11	0 to 20mA	

For using terminal [C1] for the C1, V2 or PTC function, it is necessary to make the settings as shown below.

Terminal [C1]	SW3	SW4	E59	H26	C40
For use of C1 function (4 to 20 mA)	C1	AI	0	0	0, 10
For use of C1 function (0 to 20 mA)	C1	AI	0	0	1, 11
For use of V2 function (0 to +10V)	V2	AI	1	0	Does not matter
For use of PTC function	C1	PTC	Does not matter	1, 2	Does not matter

For details about SW3 and SW4, refer to Chapter 2, Section 2.2.8.

Expected operation may not be obtained if the settings above are not switched correctly. Use sufficient caution.

■ Gain/bias

Terminal	PID command, feedback, analog monitor
[12]	
[C1] (C1 function)	
[C1] (V2 function)	

These are biases and bias base points used for PID command, PID feedback, frequency command 2 and analog monitor. For details, refer to the description of F01 and J01.

Bias (C55, C61, C67)

- Data setting range: -100.00 to 100.00 (%)

Bias base point (C56, C62, C68)

- Data setting range: 0.00 to 100.00 (%)

Specifying the bias as a negative value allows an input to be specified as bipolar for a unipolar analog input. By setting C40 data to 10 or 11 for terminal [C1] (C1 function) or C45 data to 1 for terminal [C1] (V2 function), an input value for an analog input equal to or lower than 0 point is specified to have negative polarity.

C50	Bias (Frequency setting 1) (Bias base point) (refer to F01)
------------	--

Refer to the description of F01.

C53	Selection of normal/inverse operation (frequency setting 1)
------------	--

Switches between the between normal and inverse operation of frequency setting 1 (F01) .

For details, refer to E01 through E05 (data = 21) for the terminal command IVS (“■ Switch normal/inverse operation – “IVS””).

C58	Analog input adjustment (for analog monitor (terminal [12])) (Display unit)
C64	Analog input adjustment (for analog monitor (terminal [C1])) (C1 function) (Display unit)
C70	Analog input adjustment (for analog monitor (terminal [C1])) (V2 function) (Display unit)

The units for the respective analog inputs can be displayed when a multi-function keypad (TP-A1-E2C) is used. Set these codes to use for command and feedback values of the PID control and the analog input monitor. Use the multi-function keypad to display the SV and PV values of the PID control and the analog input monitor on the main and sub-monitors. Indications are given in the specified units.

C58, C64, C70	Unit	C58, C64, C70	Unit	C58, C64, C70	Unit
—	—	23	L/s (flowrate)	45	mmHg (pressure)
1	No unit	24	L/min (flowrate)	46	Psi (pressure)
2	%	25	L/h (flowrate)	47	mWG (pressure)
4	r/min	40	Pa (pressure)	48	inWG (pressure)
7	kW	41	kPa (pressure)	60	K (temperature)
20	m ³ /s (flowrate)	42	MPa (pressure)	61	°C (temperature)
21	m ³ /min (flowrate)	43	mbar (pressure)	62	°F (temperature)
22	m ³ /h (flowrate)	44	bar (pressure)	80	ppm (concentration)

C59, C60	Analog input adjustment (terminal [12]) (Maximum scale, Minimum scale)
C65, C66	Analog input adjustment (terminal [C1] (C1 function)) (Maximum scale, Minimum scale)
C71, C72	Analog input adjustment (terminal [C1] (V2 function)) (Maximum scale, Minimum scale)

Values of the analog input monitor (terminals [12] and [C1] (C1 and V2 functions)) can be converted into easily recognizable physical quantities for display. This function can also be used for PID feedback and PID command values.

- Data setting range: (maximum scale and minimum scale) -999.00 to 0.00 to 9990.00

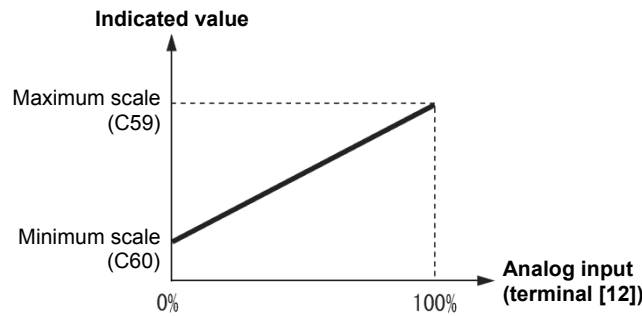

5.3.4 P codes (Motor 1 parameters)

To use the integrated automatic control functions such as auto torque boost, torque calculation monitoring, auto energy saving operation, torque limiter, automatic deceleration (anti-regenerative control), auto search for idling motor speed, slip compensation, vector control without speed sensor (torque vector), droop control, and overload stop, it is necessary to build a motor model in the inverter by specifying proper motor parameters including the motor capacity and rated current.

The FRENIC-Ace, provides built-in motor parameters for Fuji standard motors 8-series. To use these Fuji motors, it is enough to specify motor parameters for P99 (Motor 1 selection). If the cabling between the inverter and the motor is long (generally, 20 m (66 ft) or longer) or a reactor is inserted between the motor and the inverter, however, the apparent motor parameters are different from the actual ones, so auto-tuning or other adjustments are necessary.

For the auto-tuning procedure, refer to the FRENIC-Ace Instruction Manual, Chapter 4 "TEST RUN PROCEDURE."

When using a motor made by other manufacturers or a Fuji non-standard motor, obtain the datasheet of the motor and specify the motor parameters manually or perform auto-tuning.

P01**Motor 1 (No. of poles)**

P01 specifies the number of poles of the motor. Enter the value given on the nameplate of the motor. This setting is used to display the motor speed on the LED monitor and to control the speed (refer to E43). The following expression is used for the conversion.

Motor rotational speed (min^{-1}) = $120/\text{No. of poles} \times \text{Frequency (Hz)}$

- Data setting range: 2 to 22 (poles)

P02**Motor 1 (Rated capacity)**

P02 specifies the rated capacity of the motor. Enter the rated value given on the nameplate of the motor.

P02 data	Unit	Function
0.01 to 1000	kW	When P99 (Motor 1 selection) = 0, 4, 20 or 21
	HP	When P99 (Motor 1 selection) = 1

When accessing P02 with the keypad, take into account that the P02 data automatically updates data of P03, P06 through P13, P53 and H46.

P03**Motor 1 (Rated current)**

P03 specifies the rated current of the motor. Enter the rated value given on the nameplate of the motor.

- Data setting range: 0.00 to 2000 (A)

P04	Motor 1 (Auto-tuning)
------------	------------------------------

The inverter automatically detects the motor parameters and saves them in its internal memory. Basically, it is not necessary to perform tuning when a Fuji standard motor is used with a standard connection with the inverter.

There are two types of auto-tuning as listed below. Select the appropriate one considering the limitations in your equipment and control mode.

P04 data	Auto-tuning	Action	Motor parameters to be tuned	
0	Disable	—	—	
1	Tune the motor while it is stopped	Tunes while the motor is stopped.	IM	Primary resistance (%R1) (P07) Leakage reactance (%X) (P08) Rated slip frequency (P12) %X correction factors 1 (P53)
			PM	Armature resistance (P60) d-axis inductance (P61) q-axis inductance (P62) Reserved (P84, P88)
2	Tune the motor while it is rotating.	After tuning the motor in a stopped state, returns it running at 50% of the base frequency.	IM	No-load current (P06) Primary resistance (%R1) (P07) Leakage reactance (%X) (P08) Rated slip frequency (P12) %X correction factor 1 (P53) Magnetic saturation factors 1 to 5 (P16 to P20)
			PM	Armature resistance (P60) d-axis inductance (P61) q-axis inductance (P62) Induced voltage (P63) Reserved (P84, P88)
5	Tune the motor while it is stopped	Tunes while the motor is stopped.	IM	Primary resistance (%R1) (P07) Leakage reactance (%X) (P08)

For details of auto-tuning, refer to the FRENIC-Ace Instruction Manual, Chapter 4 “TEST RUN PROCEDURE.”

In any of the following cases, perform auto-tuning since the motor parameters are different from those of Fuji standard motors so that the best performance cannot be obtained under some conditions.

- The motor to be driven is a non-Fuji motor or a non-standard motor.
- Cabling between the motor and the inverter is long. (Generally, 20 m (66 ft) or longer)
- A reactor is inserted between the motor and the inverter.

Other applicable cases

■ Functions whose performance is affected by the motor parameters

Function	Related function codes (representative)
Auto torque boost	F37
Output torque monitor	F31, F35
Load factor monitor	F31, F35
Auto energy saving operation	F37
Torque limit control	F40
Anti-regenerative control (Automatic deceleration)	H69
Auto search	H09
Slip compensation	F42
V/f control with speed sensor and auto torque boost	F42
Droop control	H28
Torque detection	E78 to E81
Brake Signal (Brake-release torque)	J95
Vector control with speed sensor	F42

P05

Motor 1 (Online tuning)

When vector control without speed sensor (dynamic torque vector) or slip compensation control is used for long-time operation, the motor parameters change along with motor temperature rise.

If motor parameters change, the amount of speed compensation may change to cause the motor speed to be different from the initial speed.

Enabling auto-tuning allows the identification of the motor parameters that match the change in the motor temperature, which minimizes the motor speed variation.

To use this function, specify "2" for auto-tuning (P04).



Online tuning is enabled only when F42 = 1 (Vector control without speed sensor) or F42 = 2 (V/f control with slip compensation active) and F37 = 2, 5 (auto torque boost).

P06 to P08**Motor 1 (No-load current, %R1 and %X)**

P06 through P08 specify no-load current, %R1 and %X, respectively. Obtain the appropriate values from the test report of the motor or by calling the manufacturer of the motor. Performing auto-tuning automatically sets these parameters.

- No-load current: Input the value obtained from the motor manufacturer.
- %R1: Enter the value calculated by the following expression.

$$\%R1 = \frac{R1 + \text{Cable } R1}{V / (\sqrt{3} \times I)} \times 100 (\%)$$

R1: Primary resistance of the motor (Ω)

Cable R1: Resistance of the output cable (Ω)

V: Rated voltage of the motor (V)

I: Rated current of the motor (A)

- %X: Enter the value calculated by the following expression.

$$\%X = \frac{X1 + X2 \times XM / (X2 + XM) + \text{Cable } X}{V / (\sqrt{3} \times I)} \times 100 (\%)$$

X1: Primary leakage reactance of the motor (Ω)

X2: Secondary leakage reactance of the motor (converted to primary) (Ω)

XM: Exciting reactance of the motor (Ω)

Cable X: Reactance of the output cable (Ω)

V: Rated voltage of the motor (V)

I: Rated current of the motor (A)



For reactance, use the value at the base frequency (F04).

P09 to P11**Motor 1 (slip compensation gain for driving, slip compensation response time and slip compensation gain for braking)**

P09 and P11 determine the slip compensation amount in % for driving and braking individually and adjust the slip amount from internal calculation. Mode of 100% fully compensates for the rated slip of the motor. Excessive compensation (100% or more) may cause hunting (undesirable oscillation of the system), so carefully check the operation on the actual machine.

P10 determines the response time for slip compensation. Basically, there is no need to modify the default setting. If you need to modify it, consult your Fuji Electric representatives.

Function code		Operation (slip compensation)
P09	Slip compensation gain for driving	Adjust the slip compensation amount for driving. Slip compensation amount for driving = Rated slip \times Slip compensation gain for driving
P11	Slip compensation gain for braking	Adjust the slip compensation amount for braking. Slip compensation amount for braking = Rated slip \times Slip compensation gain for braking
P10	Slip compensation response time	Specify the slip compensation response time. Basically, there is no need to modify the setting.



For details about slip compensation control, refer to the description of F42.

P12**Motor 1 (rated slip frequency)**

P12 specifies rated slip frequency. Obtain the appropriate values from the test report of the motor or by calling the manufacturer of the motor. Performing auto-tuning automatically sets these parameters.

- Rated slip frequency: Convert the value obtained from the motor manufacturer to Hz using the following expression and enter the converted value.

(Note: The motor rated value on the nameplate sometimes shows a larger value.)

$$\text{Rated slip frequency (Hz)} = \frac{(\text{Synchronous speed} - \text{Rated speed})}{\text{Synchronous speed}} \times \text{Base frequency}$$



For details about slip compensation control, refer to the description of F42.

P13**Motor 1 (iron loss factor 1)**

The combination of P99 (Motor 1 selection) and P02 (Motor 1 rated capacity) data determines the standard value. Basically, there is no need to modify the setting.

P16 to P20**Motor 1 (Magnetic saturation factors 1 to 5)**

The combination of P99 (Motor 1 selection) and P02 (Motor 1 rated capacity) data determines the standard value. Performing auto-tuning while the motor is rotating (P04 = 2) sets the value of these factors automatically.

P30	PMSM drive Motor 1 (Magnetic pole position detection mode) Related function codes: P74:PMSM Motor 1 (Reference current at starting) P87:PMSM Motor 1 (Reference current for polarity discrimination)
------------	---

P30 specifies the magnetic pole position detection mode. Select the appropriate mode that matches the PMSM to be used.

Data for P30	Function	Remarks
0: Pull-in by current	No magnet pole position detection is made. At the start of driving the motor, the inverter supplies current specified by P74 to pull in the magnetic pole position. In this position detection mode, the motor may rotate slightly in the direction opposite to the commanded direction depending upon the current motor shaft position.	—
1: For IPMSM (Interior permanent magnet synchronous motor)	The inverter starts the motor with the magnetic pole position detection suitable for IPMSM. The reference current for polarity discrimination specified by P87 applies. Usually it is not necessary to change the factory default.	—
2: For SPMSM (Surface permanent magnet synchronous motor)	The inverter starts the motor with the magnetic pole position detection suitable for SPMSM.	—
3: Pull-in by current for IPMSM (Interior permanent magnet synchronous motor)	The inverter starts the motor with the magnetic pole position detection suitable for IPMSM causing no magnetic saturation. In this position detection mode, the motor may rotate slightly in the direction opposite to the commanded direction depending upon the current motor shaft position.	—

 **Tip** The reference current for polarity discrimination specified by P87 applies. Usually it is not necessary to change the factory default.

 **Note** During the magnetic pole position pull-in operation or the magnetic pole position detection, the motor cannot generate enough torque. When applying to the application which needs torque at start, engage the mechanical brake by using brake signal **BRKS** until magnetic pole position pull-in operation is completed. (📖 Function code E20)

P53	Motor 1 (%X correction factor 1)
------------	---

This is a factor for correcting the variation of leakage reactance %X. Basically, there is no need to modify the setting.

P55	Motor 1 (Torque current under vector control)
P56	Motor 1 (Induced voltage factor under vector control)

P55 specifies the rated torque current; P56 specifies the induced voltage factor under vector control with speed sensor.

The combination of P99 (Motor 1 selection) and P02 (Motor 1 rated capacity) data determines the standard value. Basically, there is no need to modify the setting.

P60 to P64	PMSM Motor 1 (Armature resistance, d-axis inductance, q-axis inductance, Induced voltage, and Iron loss)
-------------------	--

P60 through P64 specify the armature resistance, d-axis inductance, q-axis inductance, induced voltage and iron loss of the motor, respectively.

The combination of P99 (Motor 1 selection) and P02 (Motor 1 rated capacity) data determines the standard value. Basically, there is no need to modify the setting.

P65, P85**PMSM Motor 1 (d-axis inductance magnetic saturation correction, Flux limitation value)**

These are the control parameter for PMSMs. Normally, it is not necessary to change the data of these function codes.

P74**PMSM Motor 1 (Reference current at starting)**

Refer to P30.

**P83, P84,
P86, P88,
P89****PMSM Motor 1 (Reserved)**

These function codes are displayed, but they are reserved for particular manufacturers. Unless otherwise specified, do not access these function codes.

P90**PMSM Motor 1 (Overcurrent protection level)**

A PMSM has a current limit to prevent demagnetization of permanent magnet. If a current exceeding that limit flows through the motor, it weakens the magnet force of permanent magnet so that the motor does not get the desired characteristics.

To prevent it, P90 specifies the overcurrent protection level. If a current flows exceeding the level, the inverter causes an overcurrent protection alarm *OC1*, *OC2* or *OC3*.

P99**Motor 1 selection**

P99 specifies the motor type to be used.

P99 data	Function
0	Motor characteristics 0 (Fuji standard IM, 8-series)
1	Motor characteristics 1 (HP rating IMs)
4	Other IMs
20	Other PMSMs
21	Motor characteristics PM (Fuji standard PMSM, GNB-series)

To select the motor drive control or to run the inverter with the integrated automatic control functions such as auto torque boost and torque calculation monitoring, it is necessary to specify the motor parameters correctly.



First select the motor type with P99 from Fuji standard motors 8-series, set P02 (capacity) and then initialize the motor parameters with H03. This process automatically configures the related motor parameters (P01, P03, P06 through P13, P53 and H46).

The data of F09 (Torque boost 1), H13 (Restart mode after momentary power failure (Restart time)), and F11 (Electronic thermal overload protection for motor 1 (Overload detection level)) depends on the motor capacity, but the process stated above does not change them. Specify and adjust the data during a test run if needed.

5.3.5 H codes (High performance functions)

H02, H03	Data initialization (Method, Target) Related function codes: H193,H194 User initialization data (Save, Protect)
-----------------	--

Initialize all function code data to the factory defaults. The motor parameters are also initialized.

To change the H02/ H03 data, it is necessary to press the  + / keys (simultaneous keying).

H03 data	Function
0	Disable initialization (Settings manually made by the user will be retained.)
1	Initialize all function codes (initialization in accordance with function code H02 setting)
2	Initialize motor 1 parameters in accordance with F42(Drive control selection 1), P02 (Rated capacity) and P99 (Motor 1 selection)
3	Initialize motor 2 parameters in accordance with A16 (Rated capacity) and A39 (Motor 2 selection)
11	Limited initialization (initialization other than communications function codes): Communication can be continued after initialization.
12	Limited initialization (initialization of customizable logic function U codes only)

- When all function codes are initialized, select the initialization method in advance with function code H02.

Selection of H02		Initialization method when 1 is set to H03
Data=0	Fuji standard initial value	Initialize all function codes with the Fuji Electric standard factory defaults.
Data=1	User initial value	Initialize the value with the user setting value saved by H194. If the user initial value is not saved, initialize it with Fuji standard initial value (H02=0).

 For saving the user initial value, refer to items in function codes H193 and H194.

- To initialize the motor parameters, set the related function codes as follows.

Step	Item	Data	Function code	
			1st motor	2nd motor
(1)	Motor selection	Selects the motor type	P99	A39
(2)	Motor (rated capacity)	Sets the motor capacity (kW)	P02	A16
(3)	Data initialization	Initialize motor parameters	H03 = 2	H03 = 3
Function code data to be initialized Please refer to the F42 when using PMSM drive (F42=15)			P01, P03, P05 to P20, P30, P53 to P56, P60 to P65, P74, P83 to P90, H46	A15, A17, A20 to A27, A30 to A34, A53 to A56

- Upon completion of the initialization, the H03 data reverts to "0" (factory default).
- If P02/A16 data is set to a value other than the standard nominal applied motor rating, data initialization with H03 internally converts the specified value parameters values to the standard nominal applied motor rating. (See "5.2.4 Motor constant.")
- Motor parameters to be initialized are for motors listed below under V/f control. When the base frequency, rated voltage, and the number of poles are different from those of the listed motors, or when non-Fuji motors or non-standard motors are used, change the rated current data to that printed on the motor nameplate.

Motor selection		V/f control data
Data = 0 or 4	Fuji standard motors, 8-series	4 poles 200 V/50 Hz, 400 V/50 Hz
Data = 1	HP rating motors	4 poles 230 V/60 Hz, 460 V/60 Hz

 When accessing P02 with the keypad, take into account that the P02 data automatically updates data of P03, P06 through P13, P53 and H46. Also, when accessing function code A16 for the 2nd motor, data of related function codes for each are automatically updated.



H193, H194	User initial value (save, protection) Relevant function code: Initialization of H02 and H03 data (initial value selection and target)
-----------------------	--

The value can be saved in the non-volatile memory in the inverter so that customers may use the setting value changed from the Fuji Electric standard factory default value as the initial value for inverter initialization.

The setting value saved and protected here can be selected as the user initial value for initialization with function code H03. When this function is used, set H02 data=1.

If initialization is performed without saved/protected setting data, it is initialized to the Fuji Electric standard factory default regardless of the H02 value.

 For data initialization, refer to function codes H02 and H03.

To change the data of function codes H02, H193 and H194, it is necessary to operate double keys “STOP key + /
 key”.

To save the user setting value, set 1 (saved as the user initial value) to function code H02 in advance. In addition, function code H194 must be set to 0 (save enable).

H02 data	H194 data	Function when 1 is set to H193
0	Optional	User setting value is not saved.
1	0 : Save enable	User setting value is saved.
	1 : Protected (save disable)	User setting value is not saved.

User initial value save procedures

- (1) Set all function codes and determine the user setting value for initialization.
- (2) Set H02=1 and H194=0.
- (3) Set H193=1. The user setting value is saved.
- (4) Set H194=1. The user setting value is protected.



When the setting value of the function code has already saved by H193 and the step of H193 is repeated again, the saved data is overwritten. Be careful for error operation. To prevent overwriting by error, it is recommended to protect the data with H194 data=1 after saving.

H04, H05	Auto-reset (Times and reset interval)
-----------------	--

H04 and H05 specify the auto-reset function that makes the inverter automatically attempt to reset the tripped state and restart without issuing an alarm output (for any alarm) even if any protective function subject to reset is activated and the inverter enters the forced-to-stop state (tripped state). If the protective function is activated in excess of the times specified by H04, the inverter will issue an alarm output (for any alarm) and not attempt to auto-reset the tripped state.

Listed below are the protective functions subject to auto-reset.

Protective function	LED monitor displays:	Protective function	LED monitor displays:
Overcurrent protection	<i>OC 1, OC2, OC3</i>	Motor overheat	<i>OH4</i>
Overvoltage protection	<i>OU 1, OU2, OU3</i>	Braking resistor overheat	<i>dbH</i>
Heat sink overheat	<i>OH 1</i>	Motor overload	<i>OL 1, OL2</i>
Inverter internal overheat	<i>OH3</i>	Inverter overload	<i>OLU</i>

■ **Number of reset times (H04)**

H04 specifies the number of reset times for the inverter to automatically attempt to escape the tripped state. When H04 = 0, the auto-reset function will not be activated.

- Data setting range: 0 (Disable), 1 to 20 (times)

⚠ CAUTION

If the “auto-reset” function has been specified, the inverter may automatically restart and run the motor stopped due to a trip fault, depending on the cause of the tripping. Design the machinery so that human body and peripheral equipment safety is ensured even when the auto-resetting succeeds.

Otherwise an accident could occur.

■ **Reset interval (H05)**

- Data setting range: 0.5 to 20.0 (s)

H05 specifies the reset interval time between the time when the inverter enters the tripped state and the time when it issues the reset command to attempt to auto-reset the state. Refer to “Operation timing scheme” below.

<Operation timing scheme>

- In the figure below, normal operation restarts in the 4-th retry.

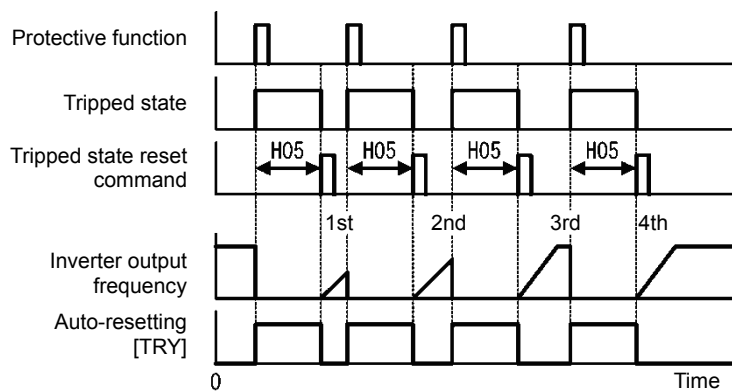

- In the figure below, the inverter failed to restart normal operation within the number of reset times specified by H04 (in this case, 3 times (H04 = 3)), and issued the alarm output (for any alarm) ALM.

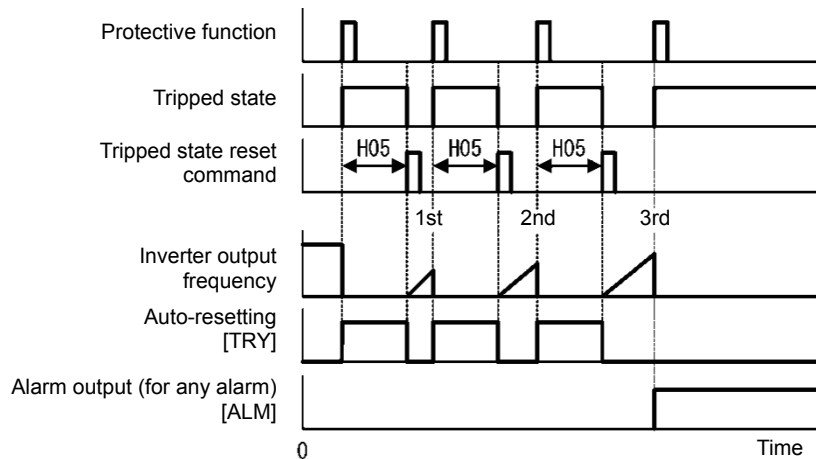

- The auto-reset operation can be monitored from the external equipment by assigning the digital output signal TRY to any of the programmable, output terminals [Y1], [Y2] or [30A/B/C] by setting E20, E21 or E27 respectively (data = 26).

H06 Cooling fan ON/OFF control

To prolong the service life of the cooling fan and reduce fan noise during running, the cooling fan stops when the temperature inside the inverter drops below a certain level while the inverter stops. However, since frequent switching of the cooling fan shortens its service life, the cooling fan keeps running for at least 10 minutes once started.

H06 specifies whether to keep running the cooling fan all the time or to enable ON/OFF control.

H06 data	Function
0	Disable (Always in operation)
1	Enable (ON/OFF controllable)

■ **Cooling fan in operation -- FAN (E20, E21 and E27, data = 25)**

With the cooling fan ON/OFF control enabled (H06 = 1), this output signal is ON when the cooling fan is in operation, and OFF when it is stopped. This signal can be used to make the cooling system of peripheral equipment interlocked for an ON/OFF control

H07 Curve acceleration/ deceleration (refer to F07)

For details, refer to the description of F07.

H08 Rotational direction limitation

H08 inhibits the motor from running in an unexpected rotational direction due to miss-operation of run commands, miss-polarization of frequency commands, or other mistakes.

H08 data	Function
0	Disable
1	Enable (Reverse rotation inhibited)
2	Enable (Forward rotation inhibited)

H09, d67	Starting mode (Auto search) Related function codes: H49 (Starting mode, auto search delay time 1) H46 (Starting mode, auto search delay time 2)
----------	--

Specify the mode for auto search without stopping the idling motor. The mode can be specified for each restart after momentary power failure and each start of normal operation. The starting mode can be switched by assigning “STM” to a general-purpose digital input signal. If it is not assigned, “STM” is regarded to be OFF. (Data = 26)

■ **H09/d67 (Starting mode, auto search) and terminal command “STM” (“Enable auto search for idling motor speed at starting”)**

The combination of H09 data and the “STM” status determines whether to perform the auto search as listed below.

Function code	Drive control	Factory default
H09	V/f control (F42 = 0 to 2)	0: Disable
d67	Vector control for synchronous motor without pole position sensor nor speed sensor (F42 = 15)	2: Enable

H09/d67 data	Enable auto search for idling motor speed at starting “STM”	Auto search for idling motor speed at starting	
		Restart mode after momentary power failure (F14 = 3 to 5)	For normal startup
0: Disable	OFF	Disable	Disable
1: Enable	OFF	Enable	Disable
2: Enable	OFF	Enable	Enable
—	ON	Enable	Enable

When “STM” is ON, auto search for idling motor speed at starting is enabled regardless of the H09/d67 setting. (📖 Function codes E01 to E05, data =26)

Auto search for idling motor speed to follow

Starting the inverter (with a run command ON, BX OFF, auto-reset, etc.) with STM being ON searches for the idling motor speed for a maximum of 1.2 seconds to run the idling motor without stopping it. After completion of the auto search, the inverter accelerates the motor up to the reference frequency according to the frequency command and the preset acceleration time.

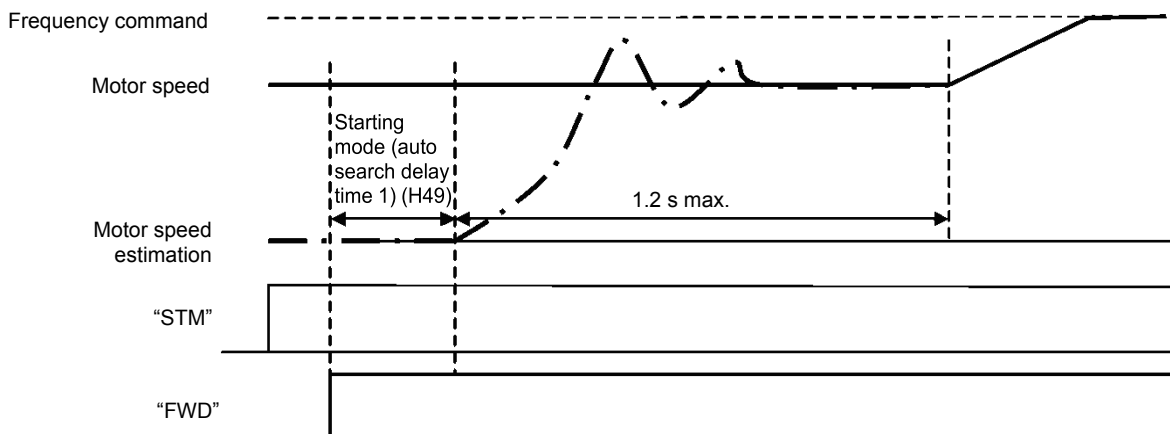

■ Starting mode (auto search delay time 1) (H49)

- Data setting range: 0.0 to 10.0 (s)

Auto search does not function normally when performed with the residual voltage remaining in the motor.

Accordingly, time to allow the residual voltage to disappear must be ensured.

When operation is started by turning a run command ON, auto search is started after the period specified with the starting mode (auto search delay time 1) (H49) has elapsed. When switching between two inverters for controlling one motor and if the motor is coasting to stop at the time of switching to start by auto search, by specifying H49 eliminates the need for timing the run command.

■ Starting mode (auto search delay time 2) (H46)

- Data setting range: 0.1 to 20.0 (s)

At the restart after a momentary power failure, at the start by turning the terminal command “BX” (“Coast to a stop”) OFF and ON, or at the restart by auto-reset, the inverter applies the delay time specified by H46. The inverter will not start unless the time specified by H46 has elapsed, even if the starting conditions are satisfied. The inverter starts after the auto search delay time has elapsed.

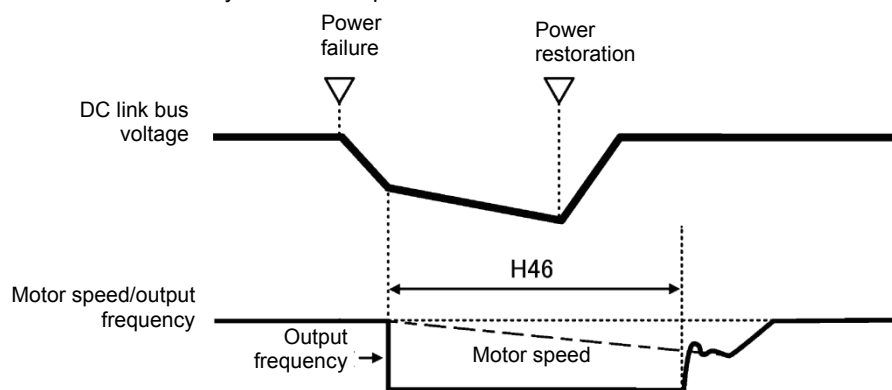

Under auto search control, the inverter searches the motor speed with the voltage applied at the motor start and the current flowing in the motor, based on the model built with the motor parameters. Therefore, the search is greatly influenced by the residual voltage in the motor.

H46 is available for motor 1 only. At factory shipment, H46 data is preset to a correct value according to the motor capacity for the general-purpose motor, and basically there is no need to modify the data.

Depending on the motor characteristics, however, it may take time for residual voltage to disappear (due to the secondary thermal time constant of the motor). In such a case, the inverter starts the motor with the residual voltage remaining, which will cause an error in the speed search and may result in occurrence of an inrush current or an overvoltage alarm.

If it happens, increase the value of H46 data and remove the influence of residual voltage.

(If possible, it is recommended to set the value around two times as large as the factory default value allowing a margin.)



- Be sure to auto-tune the inverter preceding the start of auto search for the idling motor speed.
- When the estimated speed exceeds the maximum frequency or the upper limit frequency, the inverter disables auto search and starts running the motor with the maximum frequency or the upper limit frequency, whichever is lower.
- During auto search, if an overcurrent or overvoltage trip occurs, the inverter restarts the suspended auto search.
- Perform auto search at 60 Hz or below.



Note that auto search may not fully provide the performance depending on load conditions, motor parameters, wiring length, and other external factors.

H11	Deceleration mode
------------	--------------------------

H11 specifies the deceleration mode to be applied when a run command is turned OFF.

H11 data	Action
0	Normal deceleration
1	The inverter immediately shuts down its output, so the motor stops according to the inertia of the motor and machinery (load) and their kinetic energy losses.

 **Note** When reducing the reference frequency, the inverter decelerates the motor according to the deceleration commands even if H11 = 1 (Coast-to-stop).

H12	Instantaneous overcurrent limiting (Mode selection)	(refer to F43)
------------	--	-----------------------

Refer to the descriptions of F43 and F44.

H13, H14 H15, H16	Restart mode after momentary power failure (Restart time, frequency fall rate) Restart mode after momentary power failure (Continue to run level, allowable momentary power failure time)	(refer to F14)
------------------------------	--	-----------------------

For how to set these function codes (Restart time, Frequency fall rate, Continue to run level and Allowable momentary power failure time), refer to the description of F14.

H18	Torque control (Mode selection) Related functions: d32, d33 (Speed limits / Over speed level 1 and 2) d35 (Over speed detection level)
------------	---

When vector control with speed sensor is selected, the inverter can control the motor-generating torque according to a torque command sent from external sources.

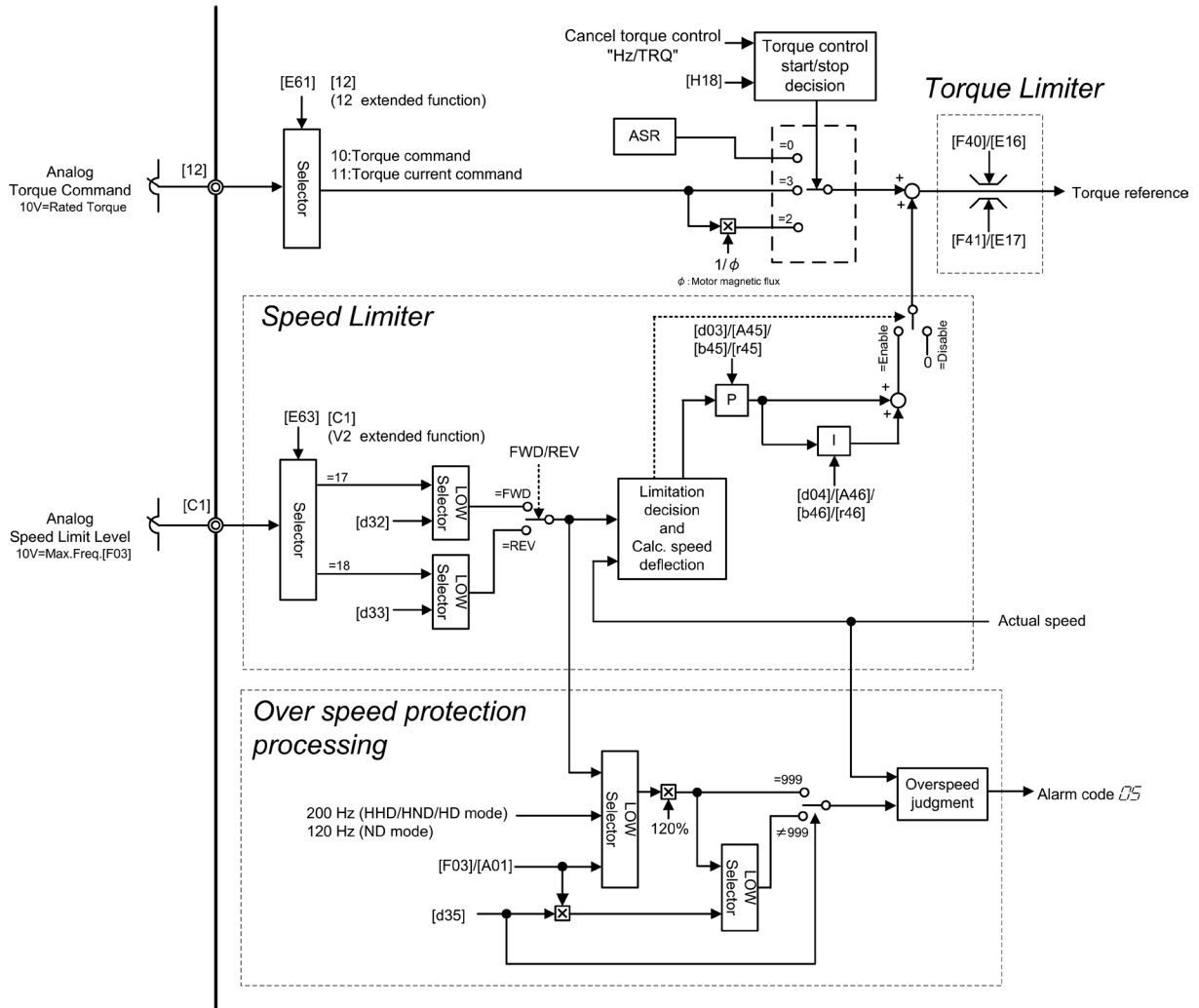

Figure 5.3-11 Block Diagram of Torque Control

■ Torque control (Mode selection) (H18)

H18 specifies whether to enable or disable the torque control. Enabling the torque control offers two choices: with torque current command and with torque command.

Data for H18	Available control
0	Disable (Speed control)
2	Enable (Torque control with torque current command)
3	Enable (Torque control with torque command)

■ Torque Commands

Torque commands can be given as analog voltage input (via terminals [12] and [C1](V2 function)) or analog current input (via terminal [C1](C1 function)), or via the communications link (communication-dedicated function codes S02 and S03). To use analog voltage/current inputs, it is necessary to set E61 (for terminal [12]), E62 (for terminal [C1](V2 function)), or E63 (for terminal [C1](V2 function)) data to "10" or "11."

Input	Command form	Function code setting	Specifications
Terminal [12] (-10 V to 10 V)	Torque command	E61 = 10	Motor rated torque $\pm 200\%$ / ± 10 V
	Torque current command	E61 = 11	Motor rated torque current $\pm 200\%$ / ± 10 V
Terminal [C1] (V2 function) (0 V to 10 V)	Torque command	E63 = 10	Motor rated torque 200% / 10V
	Torque current command	E63 = 11	Motor rated torque current 200% / 10V
Terminal [C1] (C1 function) (0/4 to 20 mA)	Torque command	E62 = 10	Motor rated torque 200% / 20 mA
	Torque current command	E62 = 11	Motor rated torque current 200% / 20 mA
S02 (-327.68 to 327.67%)	Torque command	—	Motor rated torque / $\pm 100.00\%$
S03 (-327.68 to 327.67%)	Torque current command	—	Motor rated torque current / $\pm 100.00\%$

■ Polarity of Torque Commands

The polarity of a torque command switches according to the combination of the polarity of an external torque command and a run command on terminal [FWD] or [REV], as listed below.

Polarity of torque command	Run command (ON)	Torque polarity
Positive	"FWD"	Positive torque (Forward driving/Reverse braking)
	"REV"	Negative torque (Forward braking/Reverse driving)
Negative	"FWD"	Negative torque (Forward braking/Reverse driving)
	"REV"	Positive torque (Forward driving/Reverse braking)

■ Cancel torque control -- "Hz/TRQ" (E01 to E05, data = 23)

When torque control is enabled (H18 = 2 or 3), assigning the terminal command **Hz/TRQ** ("Cancel torque control") to any of the general-purpose digital input terminals (data = 23) enables switching between speed control and torque control.

Cancel torque control signal "Hz/TRQ"	Operation
ON	Cancel torque control (Enable speed control)
OFF	Enable torque control

■ Speed limits 1 and 2 (d32, d33)

Torque control mode controls the motor-generating torque directly, not the speed. The speed is determined secondarily by torque of the load, inertia of the machinery, and other factors. To prevent a dangerous situation, therefore, the speed limit functions (d32 and d33) are provided inside the inverter.

The speed limit levels can be set to forward or reverse individually.

- Forward speed limit level = Maximum frequency 1 (F03) \times Speed limit 1 (d32) (%)
- Reverse speed limit level = Maximum frequency 1 (F03) \times Speed limit 2 (d33) (%)

■ Speed limit value by analog input (E61, E62 and E63)

You can also enter from the analog input the speed limit value. Refer to E61, E62 and E63.

- Forward speed limit level = Maximum frequency 1 (F03) × FWD speed limit value (analog input) (%)
- Reverse speed limit level = Maximum frequency 1 (F03) × REV speed limit value (analog input) (%)

■ Over speed detection level (120% of the specified speed limit levels)

If a regenerative load (which is not generated usually) is generated under droop control or function codes are incorrectly configured, then the motor may rotate at an unintended high speed. To protect the machinery, it is possible to specify the overspeed level with d32 and d33 as follows.

- Forward overspeed level = Maximum frequency 1 (F03) × Speed limit 1 (d32) × 120 (%)
- Reverse overspeed level = Maximum frequency 1 (F03) × Speed limit 2 (d33) × 120 (%)

■ Over speed detection level (d35)

Setting d35 data to “999(factory default)” causes the inverter to issue an over speed alarm if either of the above conditions are satisfied.

or

Motor speed = 200 Hz (120Hz at [ND] mode) × (d32 or d33) × 120(%)

d35 specifies the over speed detection level by percentage of the maximum frequency (F03/A01).

- Over speed level = Maximum frequency 1 (F03/A01) × d35



Running/stopping the motor

Under torque control, the inverter does not control the speed, so it does not perform acceleration or deceleration by soft-start and stop (acceleration/deceleration time) at the time of startup and stop. Turning ON a run command starts the inverter to run and output the commanded torque. Turning it OFF stops the inverter so that the motor coasts to a stop.

H26, H27

Thermistor (for motor) (Mode selection and level)

These function codes specify the PTC (Positive Temperature Coefficient) thermistor embedded in the motor. The thermistor is used to protect the motor from overheating or output an alarm signal.

■ Thermistor (for motor) (mode selection) (H26)

H26 selects the function operation mode (protection or alarm) for the PTC thermistor as shown below.

H26 data	Action
0	Disable
1	When the voltage sensed by PTC thermistor exceeds the detection level, motor protective function (alarm 0h4) is triggered, causing the inverter to enter an alarm stop state.
2	When the voltage sensed by the PTC thermistor exceeds the detection level, a motor alarm signal is output but the inverter continues running. You need to assign the “Motor overheat detected by thermistor” signal (“THM”) to one of the digital output terminals beforehand, by which a temperature alarm condition is indicated to the peripheral equipment (E20, E21 and E27, data = 56).

If H26 data is set to “1” or “2” (PTC thermistor), the inverter monitors the voltage sensed by PTC thermistor and protects the motor even when the 2nd motor is selected.

■ Thermistor (for motor) (level) (H27)

H27 specifies the detection level (expressed in voltage) for the temperature sensed by the PTC thermistor.

- Data setting range: 0.00 to 5.00 (V)

The alarm temperature at which the overheat protection becomes activated depends on the characteristics of the PTC thermistor. The internal resistance of the thermistor will significantly change at the alarm temperature. The detection level (voltage) is specified based on the change of the internal resistance.

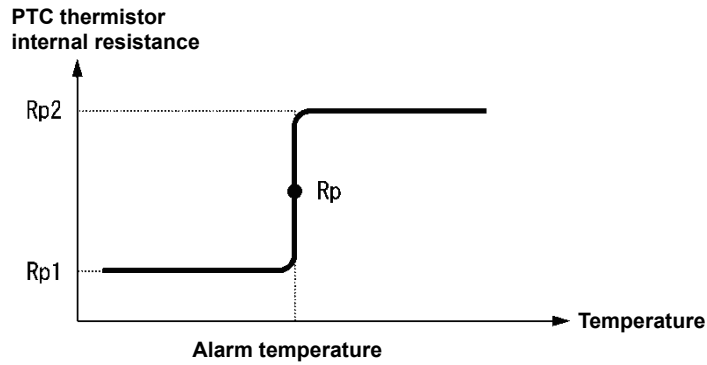

Suppose that the internal resistance of the PTC thermistor at the alarm temperature is R_p , the detection level (voltage) V_{V2} is calculated by the expression below. Set the value of V_{V2} to function code H27.

$$V_{V2} = \frac{R_p}{1000 + 5 \times R_p} \times 10.5(V)$$

Connect the PTC thermistor as shown below. The voltage obtained by dividing the input voltage on terminal [C1] with a set of internal resistors is compared with the detection level voltage specified by H27.

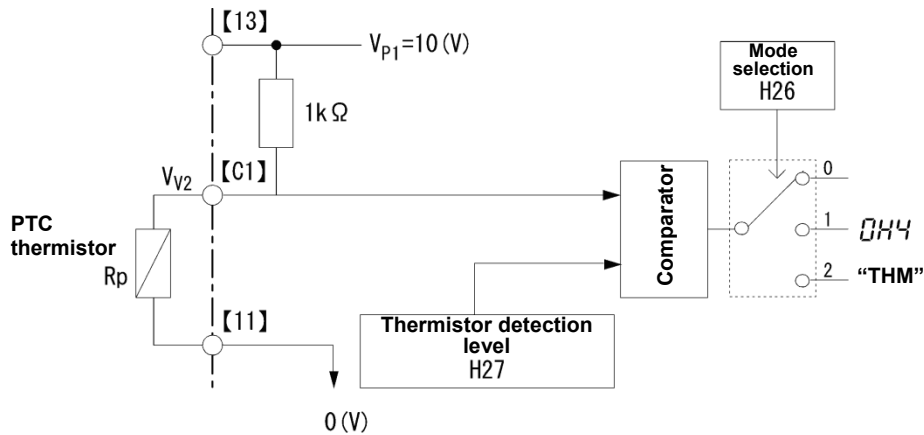

Note When using the terminal [C1] for PTC thermistor input, also set SW4 on the control printed circuit board to the PTC side. For details, refer to Chapter 2, Section 2.2.8.

H28	Droop control
------------	----------------------

In a system in which two or more motors drive single machinery, any speed gap between inverter-driven motors results in some load unbalance between motors. Droop control allows each inverter to drive the motor with the speed droop characteristic for increasing its load, eliminating such kind of load unbalance.

- Data setting range: -60.0 to 0.0 (Hz), (0.0: Disable)

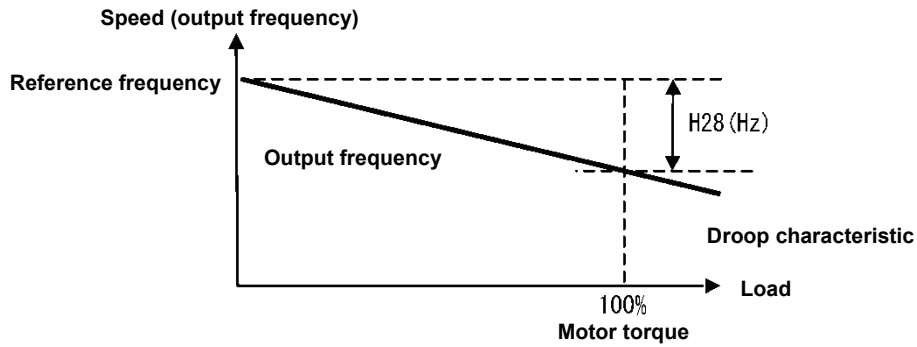

■ Select droop control – “DROOP” (E01 to E05, data = 76)

The terminal command “DROOP” toggles droop control on and off.

The terminal command “DROOP”	Droop control
ON	Enable
OFF	Disable



To use droop control, be sure to auto-tune the inverter for the motor.

Under V/f control, to prevent the inverter from tripping even at an abrupt change in load, droop control applies the acceleration/deceleration time to the frequency obtained as a result of droop control. This may delay reflection of the frequency compensated during droop control on the motor speed, thereby running the inverter as if droop control is disabled.

H30	Communication link function (Mode selection) Related function codes: y98 bus link function (mode selection)
------------	--

Using the RS-485 communications link, built-in CAN communications link or fieldbus (option) allows you to issue frequency commands and run commands from a computer or PLC at a remote location, as well as monitor the inverter running information and the function code data. It is possible to sets the source that specifies the frequency and run commands with H30 and y98. H30 and y98 set the sources that specify RS-485 communications and fieldbus respectively.

When the built-in CAN communications link is enabled with y33 = 1, the fieldbus in the figure below is replaced with the built-in CAN communications link.

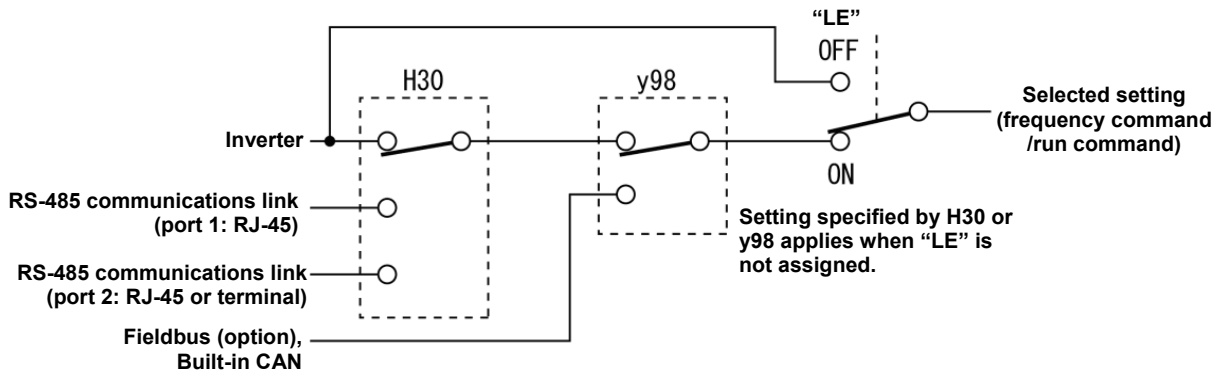

Table 5.3-11 Command sources selectable

Command sources	Data
Inverter itself	Sources except RS-485 communications link and fieldbus Frequency setting source: Specified by F01/C30, or multistep frequency command Operation method source: Via the keypad or digital input terminals selected by F02
Via RS-485 communications link (port 1)	Via the standard RJ-45 port used for connecting a keypad
Via RS-485 communications link (port 2)	GB model and C model (for China):Via the terminals DX+, DX- and SD GA model Via RJ-45 connector
Via fieldbus(option) or built-in CAN	Via fieldbus (DeviceNet, PROFIBUS DP, etc.) Via built-in CAN communications link

* C model (for China) and GB model is not equipped with the CAN communications link.

Table 5.3-12 Command sources specified by H30 (Communications link function, Mode selection)

H30 data	Frequency command	Run command source
0	Inverter itself (F01/C30)	Inverter itself (F02)
1	RS-485 communications link (port 1)	Inverter itself (F02)
2	Inverter itself (F01/C30)	RS-485 communications link (port 1)
3	RS-485 communications link (port 1)	RS-485 communications link (port 1)
4	RS-485 communications link (port 2)	Inverter itself (F02)
5	RS-485 communications link (port 2)	RS-485 communications link (port 1)
6	Inverter itself (F01/C30)	RS-485 communications link (port 2)
7	RS-485 communications link (port 1)	RS-485 communications link (port 2)
8	RS-485 communications link (port 2)	RS-485 communications link (port 2)

Table 5.3-13 Command sources specified by y98 (Bus link function, Mode selection)

y98 data	Frequency command	Run command source
0	Follow H30 data	Follow H30 data
1	Via fieldbus (option), built-in CANopen	Follow H30 data
2	Follow H30 data	Via fieldbus (option), built-in CANopen
3	Via fieldbus (option), built-in CANopen	Via fieldbus (option), built-in CANopen

Table 5.3-14 H30 and y98 settings by combination of sources

		Frequency command			
		Inverter itself	Via RS-485 communications link port 1	Via RS-485 communications link port 2	Via fieldbus (option) and built in CAN
Run command source	Inverter itself	H30 = 0 y98 = 0	H30 = 1 y98 = 0	H30 = 4 y98 = 0	H30 = 0 (1, 4) y98 = 1
	Via RS-485 communications link (port 1)	H30 = 2 y98 = 0	H30 = 3 y98 = 0	H30 = 5 y98 = 0	H30 = 2 (3, 5) y98 = 1
	Via RS-485 communications link (port 2)	H30 = 6 y98 = 0	H30 = 7 y98 = 0	H30 = 8 y98 = 0	H30 = 6 (7, 8) y98 = 1
	Via fieldbus (option and built-in CAN)	H30 = 0 (2, 6) y98 = 2	H30 = 1 (3, 7) y98 = 2	H30 = 4 (5, 8) y98 = 2	H30 = 0 (1 to 8) y98 = 3

 For details, refer to the RS-485 Communication User’s Manual, the Field Bus (Option) Instruction Manual or Chapter 9.

- When the terminal command “LE” (“Select link operation (RS-485, BUS option)”) is assigned to a digital input terminal, turning “LE” ON makes the settings of H30 and y98 enabled. When LE is OFF, those settings are disabled so that both frequency commands and run commands specified from the inverter itself take control. (Function codes E01 to E05, data = 24)
No “LE” assignment is functionally equivalent to the “LE” being ON.

H42, H43, H48	<p>Capacitance of DC link bus capacitor, Cumulative run time of cooling fan Cumulative run time of capacitors on printed circuit boards</p> <p>Related function codes: H47 Initial capacitance of DC link bus capacitor H98 Protection/maintenance function</p>
---------------	---

■ Life prediction function

The inverter has the life prediction function for some parts which measures the discharging time or counts the voltage applied time, etc. The function allows you to monitor the current lifetime state on the LED monitor and judge whether those parts are approaching the end of their service life. The life prediction function can also issue early warning signals if the lifetime alarm command LIFE is assigned to any of the digital output terminals by any of E20, E21 and E27.

The predicted values should be used only as a guide since the actual service life is influenced by the surrounding temperature and other usage environments.

Object of life prediction	Prediction function	End-of-life criteria	Prediction timing	On the LED monitor
DC link bus capacitor	<u>Calculating the capacitance of DC link bus capacitor</u> Measures the discharging time of the DC link bus capacitor when the main power is shut down and calculates the capacitance.	85% or lower of the initial capacitance at shipment (See “[1] Measuring the capacitance of DC link bus capacitor in comparison with initial one at shipment” on page 5-171.)	At periodic inspection H98 bit3 = 0	5_05 (Capacitance)
		85% or lower of the reference capacitance under ordinary operating conditions at the user site (See “[2] Measuring the capacitance of DC link bus capacitor under ordinary operating conditions at power shutdown” on page 5-172.)	During ordinary operation H98 bit3 = 1	5_05 (Capacitance)
	<u>ON-time counting of DC link bus capacitor</u> Counts the time elapsed when the voltage is applied to the DC link bus capacitor, while correcting it according to the capacitance measured above.	Exceeding 87,600 hours (10 years) (ND mode: 61,320 hours (7 years))	During ordinary operation	5_26 (Elapsed time) 5_27 (Remaining hours)
Electrolytic capacitors on printed circuit boards	Counts the time elapsed when the voltage is applied to the capacitors, while correcting it according to the surrounding temperature.	Exceeding 87,600 hours (10 years) (ND mode: 61,320 hours (7 years))	During ordinary operation	5_06 (Cumulative run time)
Cooling fans	Counts the run time of the cooling fans.	Exceeding 87,600 hours (10 years) (ND mode: 61,320 hours (7 years))	During ordinary operation	5_07 (Cumulative run time)

■ Capacitance of DC link bus capacitor (H42)**Calculating the capacitance of DC link bus capacitor**

- The discharging time of the DC link bus capacitor depends largely on the inverter's internal load conditions, e.g. options attached or ON/OFF of digital I/O signals. If actual load conditions are so different from the ones at which the initial/reference capacitance is measured that the measurement result falls out of the accuracy level required, then the inverter does not perform measuring.
- The capacitance measuring conditions at shipment are extremely restricted, e.g., all input terminals being OFF in order to stabilize the load and measure the capacitance accurately. Those conditions are, therefore, different from the actual operating conditions in almost all cases. If the actual operating conditions are the same as those at shipment, shutting down the inverter power automatically measures the discharging time; however, if they are different, no automatic measurement is performed. To perform it, put those conditions back to the factory default ones and shut down the inverter. For the measuring procedure, see "[1] Measuring the capacitance of DC link bus capacitor in comparison with initial one at shipment" on page 5-171.
- To measure the capacitance of the DC link bus capacitor under ordinary operating conditions when the power is turned OFF, it is necessary to set up the load conditions for ordinary operation and measure the reference capacitance (initial setting) when the inverter is introduced. For the reference capacitance setup procedure, see "[2] Measuring the capacitance of DC link bus capacitor under ordinary operating conditions at power shutdown" on page 5-172. Performing the setup procedure automatically detects and saves the measuring conditions of the DC link bus capacitor.

Setting bit 3 of H98 data to 0 restores the inverter to the measurement in comparison with the initial capacitance measured at shipment.

 **Note** When the inverter uses an auxiliary control power input, the load conditions widely differ so that the discharging time cannot be accurately measured. In this case, measuring of the discharging time can be disabled with the function code H98 (Bit 4 = 0) for preventing unintended measuring. (For details, refer to H98.)

ON-time counting of DC link bus capacitor

- In a machine system where the inverter main power is rarely shut down, the inverter does not measure the discharging time. For such an inverter, the ON-time counting is provided. If the capacitance measurement is made, the inverter corrects the ON-time according to the capacitance measured. The ON-time counting result can be represented as "elapsed time" and "remaining time" before the end of life.

[1] Measuring the capacitance of DC link bus capacitor in comparison with initial one at shipment

When bit 3 of H98 data is 0, the measuring procedure given below measures the capacitance of DC link bus capacitor in comparison with initial one at shipment when the power is turned OFF. The measuring result can be displayed on the keypad as a ratio (%) to the initial capacitance.

-----Capacitance measuring procedure-----

- 1) To ensure validity in the comparative measurement, put the condition of the inverter back to the state at factory shipment.
 - Remove the option card (if already in use) from the inverter.
 - In case another inverter is connected via the DC link bus to the P(+) and N(-) terminals of the main circuit, disconnect the wires. (You do not need to disconnect a DC reactor (optional), if any.)
 - Disconnect power wires for the auxiliary input to the control circuit (R0, T0).
 - In case the standard keypad has been replaced with an optional multi-function keypad TP-A1-E2C after the purchase, put back the original standard keypad.
 - Turn OFF all the digital input signals fed to terminals [FWD], [REV], and [X1] through [X5] of the control circuit
 - If a potentiometer is connected to terminal [13], disconnect it.
 - If an external apparatus is attached to terminal [PLC], disconnect it.
 - Ensure that transistor output signals ([Y1] and [Y2]) and relay output signals ([30A/B/C]) will not be turned ON.
 - Disable the RS-485 and built-in CAN communications links.

 **Note** If negative logic is specified for the transistor output and relay output signals, they are considered ON when the inverter is not running. Specify positive logic for them.

- Keep the surrounding temperature within $25 \pm 10^{\circ}\text{C}$.
- 2) Turn ON the main circuit power.
 - 3) Confirm that the cooling fan is rotating and the inverter is in stopped state.
 - 4) Turn OFF the main circuit power.
 - 5) The inverter automatically starts the measurement of the capacitance of the DC link bus capacitor. Make sure that “. . . .” appears on the LED monitor.

 **Note** If “. . . .” does not appear on the LED monitor, the measurement has not started. Check the conditions listed in 1).

- 6) After “. . . .” has disappeared from the LED monitor, turn ON the main circuit power again.
 - 7) Select Menu #5 “Maintenance Information” in Programming mode and note the reading (relative capacitance (%)) of the DC link bus capacitor).
-

[2] Measuring the capacitance of DC link bus capacitor under ordinary operating conditions at power shutdown

When bit 3 of H98 data is 1, the inverter automatically measures the capacitance of the DC link bus capacitor under ordinary operating conditions when the power is turned OFF. This measurement requires setting up the load conditions for ordinary operation and measuring the reference capacitance when the inverter is introduced to the practical operation, using the setup procedure given below.

Function code	Name	Data
H42	Capacitance of DC link bus capacitor	<ul style="list-style-type: none"> • Capacitance of DC link bus capacitor (measured value) • Start of initial capacitance measuring mode under ordinary operating conditions (0000) • Measurement failure (0001)
H47	Initial capacitance of DC link bus capacitor	<ul style="list-style-type: none"> • Initial capacitance of DC link bus capacitor (measured value) • Start of initial capacitance measuring mode under ordinary operating conditions (0000) • Measurement failure (0001)

When replacing parts, clear or modify the H42 and H47 data. For details, refer to the maintenance related documents.

-----Reference capacitance setup procedure-----

- 1) Set function code H98 (Protection/maintenance function) to enable the user to specify the judgment criteria for the service life of the DC link bus capacitor (Bit 3 = 1) (refer to function code H98).
- 2) Turn OFF all run commands.
- 3) Make the inverter ready to be turned OFF under ordinary operating conditions.
- 4) Set both function codes H42 (Capacitance of DC link bus capacitor) and H47 (Initial capacitance of DC link bus capacitor) to "0000".
- 5) Turn OFF the inverter, and the following operations are automatically performed.
The inverter measures the discharging time of the DC link bus capacitor and saves the result in function code H47 (Initial capacitance of DC link bus capacitor).
The conditions under which the measurement has been conducted will be automatically collected and saved.
During the measurement, ". . . ." will appear on the LED monitor.
- 6) Turn ON the inverter again.
Confirm that H42 (Capacitance of DC link bus capacitor) and H47 (Initial capacitance of DC link bus capacitor) hold right values. Shift to Menu #5 "Maintenance Information" and confirm that the relative capacitance (ratio to full capacitance) is 100%.

 Note If the measurement has failed, "0001" is entered into both H42 and H47. Remove the factor of the failure and conduct the measurement again.

Hereafter, each time the inverter is turned OFF, it automatically measures the discharging time of the DC link bus capacitor if the above conditions are met. Periodically check the relative capacitance of the DC link bus capacitor (%) with Menu #5 "Maintenance Information" in Programming mode.

 Note The condition given above tends to produce a rather large measurement error. If this mode gives you a lifetime alarm, set H98 (Protection/maintenance function) back to the default setting (Bit 3 (Select life judgment threshold of DC link bus capacitor) = 0) and conduct the measurement under the condition at the time of factory shipment.

■ Cumulative run time of capacitors on printed circuit boards (H48)

Function code	Name	Data
H48	Cumulative run time of capacitors on printed circuit boards	Displays the cumulative run time of capacitor on the printed circuit board in units of ten hours. • Data setting range: 0 to 9999 (0 to 99990 hours)

When replacing capacitors on printed circuit boards, clearing or modifying H48 data is required. For details, refer to the maintenance related documents.

■ Cumulative run time of cooling fan (H43)

Function code	Name	Data
H43	Cumulative run time of cooling fan	Displays the cumulative run time of cooling fan in units of ten hours. • Data setting range: 0 to 9999 (0 to 99990 hours)

When replacing the cooling fan, clearing or modifying H43 data is required. For details, refer to the maintenance related documents.

H44	Startup count for motor 1
------------	----------------------------------

H44 counts the number of inverter startups and displays it in hexadecimal format. Check the displayed number on the maintenance screen of the keypad, and use it as a guide for maintenance timing for parts such as belts. To start the counting over again, e.g. after a belt replacement, set the H44 data to "0000."

H45	Mock alarm Related function codes: H97 (Clear alarm data)
------------	--

H45 causes the inverter to generate a mock alarm in order to check whether external sequences function correctly at the time of machine setup. Setting the H45 data to "1" displays mock alarm \overline{ERR} on the LED monitor. It also issues alarm output (for any alarm) "ALM" (if assigned to a digital output terminal by any of E20, E21 and E27).

Accessing the H45 data requires simultaneous keying of the \odot key + \wedge key. After that, the H45 data automatically reverts to "0," allowing you to reset the alarm.

Same as other alarms that could occur when running the inverter, the inverter saves mock alarm data, enabling you to confirm the mock alarm status.

To clear the mock alarm data, use H97. (Accessing the H97 data requires simultaneous keying of the \odot key + \wedge key.) H97 data automatically returns to "0" after clearing the alarm data.

 **Tip** A mock alarm can be issued also by simultaneous keying of the \odot key + \oplus key on the keypad for 5 seconds or more.

H46	Starting mode (Auto search delay time 2) (refer to H09)
------------	--

For details, refer to the description of H09.

H47, H48	Initial capacitance of DC link bus capacitor, Cumulative run time of capacitors on printed circuit boards (refer to H42)
-----------------	---

For details, refer to the description of H42.

H49	Starting mode (Auto search delay time 1)	(refer to H09)
------------	---	-----------------------

For details, refer to the description of H09.

H50, H51 H52, H53	Non-linear V/f 1 (Frequency and voltage) Non-linear V/f 2 (Frequency and voltage)	(refer to F04)
------------------------------	--	-----------------------

For details, refer to the description of F04.

H54, H55 H56 H57 to H60	Acceleration/Deceleration time (Jogging) Deceleration time for forced stop 1st/2nd S-curve acceleration/deceleration range	(refer to F07)
--	---	-----------------------

For details, refer to the description of F07.

H61	UP/DOWN control (Initial frequency setting)	(refer to F01)
------------	--	-----------------------

For details, refer to the description of F01.

H63	Low limiter (Mode selection)	(refer to F15)
------------	-------------------------------------	-----------------------

For details, refer to the description of F15.

H64	Low limiter (Lower limiting frequency)
------------	---

H64 specifies the lower limit of frequency to be applied when the current limiter, torque limiter, or overload prevention control is activated. Normally, it is not necessary to change this data.

- Data setting range: 0.0 to 60.0 (Hz)

H65, H66	Non-linear V/f 3 (Frequency and voltage)	(refer to F04)
-----------------	---	-----------------------

For details, refer to the description of F04.

H68	Slip compensation 1 (Operating conditions)	(refer to F42)
------------	---	-----------------------

For details, refer to the description of F42.

H69	Anti-regenerative control (Mode selection) Related function codes: H76 (Torque limiter) (Frequency rising limit for braking)
------------	---

Enable the automatic deceleration (anti-regenerative control) with this function code. In the inverter not equipped with a PWM converter or braking unit, if the regenerative energy returned exceeds the inverter's braking capability, an overvoltage trip occurs. Turning digital input "AR-CCL" ON cancels anti-regenerative control.

( Function codes E01 to E05, data =82)

If anti-regenerative control is selected, the output frequency is controlled to suppress the regenerative energy for avoiding an overvoltage trip.

H69	Function		AR-CCL
	Control mode	Force-to-stop with actual deceleration time exceeding three times the specified one	
0	Disable automatic deceleration	—	OFF
2	Torque limit control	Enable	OFF
3	DC link bus voltage control	Enable	OFF
4	Torque limit control	Disable	OFF
5	DC link bus voltage control	Disable	OFF
—	Disable automatic deceleration	—	ON

FRENIC-Ace is equipped with two control modes: torque limiter and DC link bus voltage control. Understand the features of the respective modes and select the appropriate one.

Control mode	Control operation	Operation mode	Characteristics
Torque limiter (H69 = 2, 4)	Controls the output frequency so that the braking torque is approximately 0.	Enabled during acceleration, constant speed operation and deceleration.	Features high response and makes less prone to overvoltage trips under impact load.
DC link bus voltage control (H69 = 3, 5)	Controls the output frequency so that the DC link bus voltage is decreased when it exceeds the limit level.	Enabled only during deceleration Disabled during constant speed operation	Regenerative capability of the inverter will be maximum use. Deceleration time will be shorter than the torque limit control.

■ Torque limiter (Frequency rising limit for braking) (H76)

- Data setting range: 0.0 to 500.0 (Hz)

With the torque limiter, the inverter increases the output frequency to limit the output torque. Excessive increase of the output frequency may cause danger, and therefore the frequency increment limit for braking (H76) is provided. This prevents the output frequency from increasing to exceed the "reference frequency + H76." If the limit is reached, however, anti-regenerative control is restricted and an overvoltage trip may occur. Increasing the frequency increment limit for braking improves the anti-regenerative capability.

If a run command is turned OFF, the anti-regenerative control causes the frequency to increase and operation may not stop depending on the load conditions. For safety, a function is provided in which the anti-regenerative control is forced to be disabled if the actual deceleration time becomes three times the deceleration time currently selected forcing the operation to stop. The function can be enabled/disabled by the setting of H69.



- The deceleration time may be automatically increased by anti-regenerative control.
- Disable the anti-regenerative control when a braking unit is connected. Otherwise, the anti-regenerative control may be activated at the same time as the operation of the braking unit, resulting in a deceleration time not in accordance with the setting.
- An excessively short deceleration time causes the DC link bus voltage of the inverter to rise too fast for the anti-regenerative control to function. In that case, specify a longer deceleration time.

H70**Overload prevention control**

Specifies the rate of decrease of the output frequency of overload prevention control. Before the inverter generates a heat sink overheat or overload trip (alarm \overline{OH} / or \overline{OL}), the output frequency of the inverter is decreased for avoiding a trip. This is applied when operation is required to continue in a system in which the load decreases as the output frequency decreases, such as a pump.

H70 data	Function
0.00	Uses the deceleration time currently selected (F08, E11, E13, E15, etc.).
0.01 to 100.0	Decelerates at a deceleration rate of 0.01 to 100.0 (Hz/s).
999	Cancel overload prevention control

■ **Overload prevention controlling – “OLP” (E20, E21 and E27, data = 36)**

Outputs “OLP”, which is a signal that turns ON during overload prevention control, in order to inform that the overload prevention control has been activated and the output frequency has changed.

 **Note** No effect can be expected in a system in which the load does not decrease even if the output frequency decreases. Do not use this function.

H71**Deceleration characteristic**

Enable hard braking control with this function code.

During motor deceleration, if the regenerative energy returned exceeds the inverter's braking capability, an overvoltage trip occurs. When hard braking control is selected, the motor loss is increased and the deceleration torque is increased during motor deceleration.

H71 data	Function
0	Disable
1	Action

 **Note** This function suppresses the torque during deceleration and is not effective if braking load is applied. When anti-regenerative control of the torque limiter is enabled (H69 = 2, 4), the deceleration characteristic is disabled.

H72**Main power shutdown detection (Mode selection)**

This function monitors the AC input power supply of the inverter to see if the AC input power supply (main circuit power) is established and prevents inverter operation when the main circuit power is not established.

Available FRN0088E2■-2□/FRN0059E2■-4□ or above.

H72 data	Function
0	Disables main circuit power cutoff detection
1	Enables main circuit power cutoff detection

With power supply via a PWM converter or DC link bus, there is no AC input. When the data for H72 is “1,” the inverter cannot operate. Change the data for H72 to “0.”

 **Note** For single-phase supply, consult your Fuji Electric representatives.

H74	Torque limiter (Control target)
------------	--

Refer to F40, F41.

H76	Torque limiter (Braking) (Frequency rising limiter for braking)	(refer to H69)
------------	--	-----------------------

For details, refer to the description of H69.

H77	Service life of DC link bus capacitor (Remaining time)
------------	---

Indicates the time remaining (in units of ten hours) before the end of service life of the DC link bus capacitor. Transfer the DC link bus capacitor life data when replacing the printed circuit board.

- Data setting range: 0 to 8760 (in units of 10 hours 0 to 87,600 hours)

H78 H94	Maintenance interval (M1) Cumulative motor run time 1
--------------------------	--

Specify the maintenance interval in hours with the maintenance interval (M1) (H78). Specify in units of 10 hours. Up to 9999 x 10 hours can be specified.

- Data setting range: 0 (disable), 1 to 9999 (in units of 10 hours)

■ **Maintenance timer counted up – “MNT” (E20, E21 and E27, data = 84)**

When the cumulative motor run time 1 (H94) reaches the value specified by the maintenance interval (H78), the inverter outputs the maintenance timer signal “MNT”.

■ **Cumulative motor run time 1 (H94)**

The cumulative run time of the motor can be indicated by keypad operation. It can be used for management of the machinery or maintenance. Specifying an arbitrary time for the cumulative motor run time 1 (H94) allows an arbitrary value to be specified for the cumulative motor run time. It can be replaced with the initial data to use as a guide for the replacement of machine parts or inverter. Setting “0” allows the cumulative motor run time to be reset.

<For half yearly maintenance>

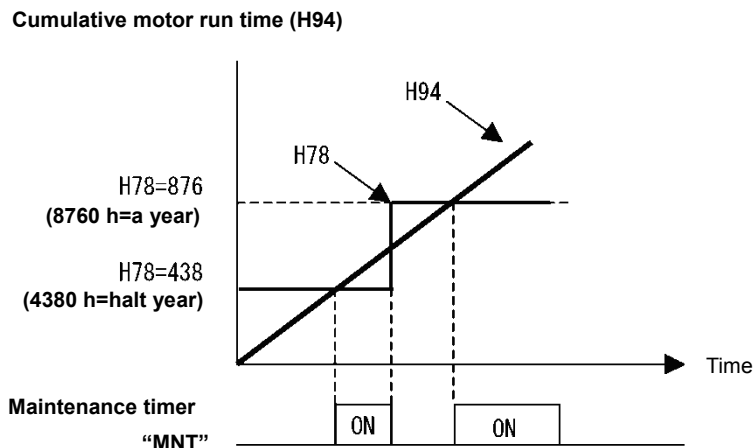

Note If the maintenance interval is reached, set a new value in H78 and press the  key to reset the output signal and restart measurement.

This function is exclusively applied to the 1st motor.

■ **Count the run time of commercial power-driven motor 1, 2 – “CRUN-M1, 2” (E01 to E05, data = 72, 73)**

Even when a motor is driven by commercial power, not by the inverter, it is possible to count the cumulative motor run time 1, 2 (H94, A51) by detecting the ON/OFF state of the auxiliary contact of the magnetic contactor for switching to the commercial power line.

Note Check the cumulative motor run time with 5.23 on Menu #5 “Maintenance Information” of the keypad.

H79	Preset startup count for maintenance (M1) Related function codes: H44 Startup count for motor 1
------------	--

H79 specifies the number of inverter startup times to determine the next maintenance timing, e.g., for replacement of a belt.

Set the H79 and H44 data in hexadecimal. The maximum setting count is 65,535 (FFFF in hexadecimal.)

- Data setting range: OFF (disable), 0001 to FFFF (hexadecimal)

■ **Maintenance timer counted up – “MNT” (E20, E21 and E27, data = 84)**

When the startup counter for motor 1 (H44) reaches the number specified by H79 (Preset startup count for maintenance (M1)), the inverter outputs the maintenance timer signal “MNT” (if assigned to any digital terminal with any to E20 to E24 and E27) to inform the user of the need of the maintenance of the machinery.

< Maintenance every 1,000 times of startups >

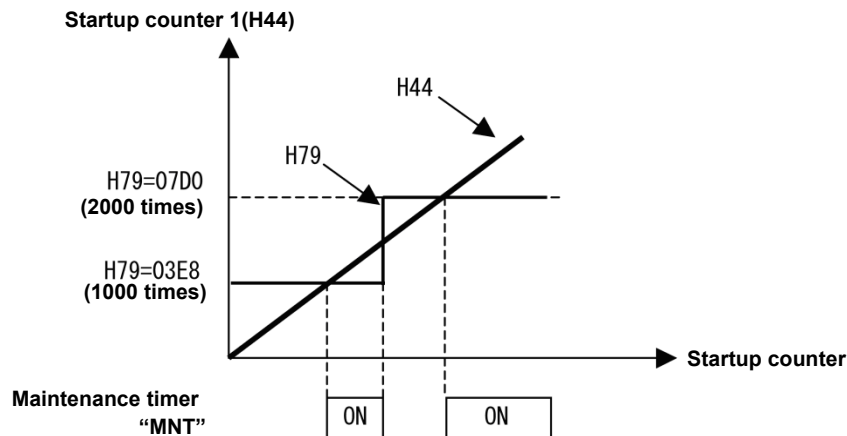

Note If the startup counter reaches the specified value, set a new value for the next maintenance in H79 and press the  key to reset the output signal and restart counting.

This function is exclusively applied to the 1st motor.

H80	Output current fluctuation damping gain for motor 1
------------	--

The inverter output current driving the motor may fluctuate due to the motor characteristics and/or backlash in the machinery (load). Modifying the H80 data adjusts the controls in order to suppress such fluctuation. However, as incorrect setting of this gain may cause larger current fluctuation, do not modify the default setting unless it is necessary.

- Data setting range: 0.00 to 1.00

H81, H82**Light alarm selection 1 and 2**

If the inverter detects a minor abnormal state “light alarm”, it can continue the current operation without tripping while displaying the “light alarm” indication $L-FL$ on the LED monitor. In addition to the indication I-al, the inverter blinks the KEYPAD CONTROL LED. Function codes H81 and H82 specify which alarms should be categorized as “light alarm.”

The table below lists alarms selectable as “light alarm.”

Code	Name	Description
$OH1$	Heat sink overheat	Heat sink temperature increased to the trip level.
$OH2$	Enable external alarm trip	An error that has occurred in peripheral equipment turned the external alarm signal THR ON.
$OH3$	Inverter internal overheat	The temperature inside the inverter abnormally has increased.
dbH	Braking resistor overheat	Estimated temperature of the coil in the braking resistor exceeded the allowable level.
$OL1$ to $OL2$	Overload of motor 1 to 2	Motor temperature calculated with the inverter output current reached the trip level.
$Er4$	Option communications error	Communications error between the inverter and an option.
$Er5$	Option error	An option judged that an error occurred.
$Er6$	Built-in CAN communications link error	Error generated in built-in CAN communications link
$Er8$ ErP	RS-485 communications error (COM port 1, 2)	RS-485 communications error in COM ports 1 or 2.
LoF	PID feedback wire break	The PID feedback signal wire(s) is broken.
FAL	Detect DC fan lock	Failure of the air circulation DC fan inside the inverter
OL	Motor overload early warning	Early warning before a motor overload
OH	Heat sink overheat early warning	Early warning before a heat sink overheat trip
LIF	Lifetime alarm	It is judged that the service life of any one of the capacitors (DC link bus capacitors or electrolytic capacitors on the printed circuit boards) or cooling fan has expired. Or, failure of the air circulation DC fan inside the inverter.
rEF	Reference loss	Analog frequency command was lost.
Pid	PID alarm	Warning related to PID control (absolute-value alarm or deviation alarm)
$LIFL$	Low output torque detection	Output torque drops below the low torque detection level for the specified period.
PTC	PTC thermistor activated	The PTC thermistor on the motor detected a high temperature.
rFE	Inverter life (Cumulative run time)	The motor cumulative run time reached the specified level.
EnF	Inverter life (Number of startups)	Number of startups reached the specified level.

Set data for selecting “light alarms” in hexadecimal. For details on how to select the codes, see the next page.

- Data setting range: 0000 to FFFF (hexadecimal)

■ Selecting light alarm factors

To set and display the light alarm factors in hexadecimal format, each light alarm factor has been assigned to bits 0 to 15 as listed in Table 5.3-15 and Table 5.3-16. Set the bit that corresponds to the desired light alarm factor to “1.” Table 5.3-17 shows the relationship between each of the light alarm factor assignments and the LED monitor display.

Table 5.3-18 gives the conversion table from 4-bit binary to hexadecimal.

Table 5.3-15 Light Alarm Selection 1 (H81), Bit Assignment of Selectable Factors

Bit	Code	Data	Bit	Code	Data
15	<i>OH5</i>	Charging resistor overheat	7	—	—
14	<i>ErE</i>	Built-in CAN communications link error	6	<i>OL2</i>	Overload of motor 2
13	<i>ErP</i>	RS-485 communications error (COM port 2)	5	<i>OL1</i>	Overload of motor 1
12	<i>ErB</i>	RS-485 communications error (COM port 1)	4	<i>dbH</i>	Braking resistor overheat
11	<i>ErS</i>	Option error	3	—	—
10	<i>Er4</i>	Option communications error	2	<i>OH3</i>	Inverter internal overheat
9	—	—	1	<i>OH2</i>	External alarm
8	—	—	0	<i>OH1</i>	Heat sink overheat

Table 5.3-16 Light Alarm Selection 2 (H82), Bit Assignment of Selectable Factors

Bit	Code	Data	Bit	Code	Data
15	—	—	7	<i>LIF</i>	Lifetime alarm
14	—	—	6	<i>OH</i>	Heat sink overheat early warning
13	<i>LrF</i>	Inverter life (Number of startups)	5	<i>OL</i>	Motor overload early warning
12	<i>rFE</i>	Inverter life (Cumulative run time)	4	<i>FAL</i>	Detect DC fan lock
11	<i>PTC</i>	PTC thermistor activated	3	<i>CoF</i>	PID feedback wire break
10	<i>LiL</i>	Low output torque detection	2	<i>ErO</i>	Positioning error
9	<i>Pid</i>	PID alarm	1	—	—
8	<i>rEF</i>	Reference loss	0	—	—

Table 5.3-17 Display of Light Alarm Factor

(Example) Light alarm factors “RS-485 communications error (COM port 2),” “RS-485 communications error (COM port 1),” “Option communications error,” “Overload of motor 1” and “Heat sink overheat” are selected by H81.

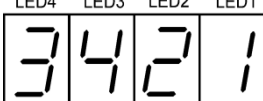
LED No.		LED 4				LED 3				LED 2				LED 1			
Bit		15	14	13	12	11	10	9	8	7	6	5	4	3	2	1	0
Code		—	—	<i>ErP</i>	<i>ErB</i>	<i>ErS</i>	<i>Er4</i>	—	—	—	<i>OL2</i>	<i>OL1</i>	<i>dbH</i>	—	<i>OH3</i>	<i>OH2</i>	<i>OH1</i>
Sample indication	Binary	0	0	1	1	0	1	0	0	0	0	1	0	0	0	0	1
	Hexadecimal * Refer to Table 5.3-18	3				4				2				1			
	Hexadecimal on the LED monitor	<div style="display: flex; justify-content: space-around; align-items: center;"> <div style="text-align: center;">LED4</div> <div style="text-align: center;">LED3</div> <div style="text-align: center;">LED2</div> <div style="text-align: center;">LED1</div> </div> 															

■ **Hexadecimal expression**

A 4-bit binary number can be expressed in hexadecimal format (hexadecimal digit). The table below shows the correspondence between the two notations.

Table 5.3-18 Binary and Hexadecimal Conversion

Binary				Hexadecimal	Binary				Hexadecimal
0	0	0	0	0	1	0	0	0	8
0	0	0	1	1	1	0	0	1	9
0	0	1	0	2	1	0	1	0	A
0	0	1	1	3	1	0	1	1	B
0	1	0	0	4	1	1	0	0	C
0	1	0	1	5	1	1	0	1	D
0	1	1	0	6	1	1	1	0	E
0	1	1	1	7	1	1	1	1	F



When H26 = 1 (PTC (The inverter immediately trips with $\overline{H-H}$ displayed)), if the PTC thermistor is activated, the inverter stops without displaying I-al, blinking the KEYPAD CONTROL LED, or outputting L-ALM signal, regardless of the assignment of bit 11 (PTC thermistor activated) by H82 (Light Alarm Selection 2).

■ **Light alarm – “L-ALM” (E20, E21 and E27, data = 98)**

This output signal “L-ALM” comes ON when a light alarm occurs.

H84, H85	Pre-excitation (Initial level, Time)
-----------------	---

A motor generates torque with magnetic flux and torque current. Lag elements of the rising edge of magnetic flux causes a phenomenon in which enough torque is not generated at the moment of the motor start. To obtain enough torque even at the moment of motor start, enable the pre-excitation with H84 and H85 so that magnetic flux is established before a motor start.

■ **Pre-excitation (Initial level) (H84)**

H84 specifies the forcing function for the pre-excitation. It is used to shorten the pre-excitation time. Basically, there is no need to modify the default setting. If the inverter determines that the magnetic flux is established, then excitation level will return to 100 percent.

- Data setting range: 100 to 400 (%) (exciting current level in percentage)

■ Pre-excitation (Time) (H85)

H85 specifies the pre-excitation time before starting operation.

- Data setting range: 0.00 (Disable), 0.01 to 30.00 (s)

When a run command is inputted, the pre-excitation starts.

After the pre-excitation time specified by H85 has elapsed, the inverter judges magnetic flux to have been established and starts acceleration.

Specify H85 data so that enough time is secured for establishing magnetic flux. The appropriate value for H85 data depends on the motor capacity. Use the default setting value of H13 data as a guide.

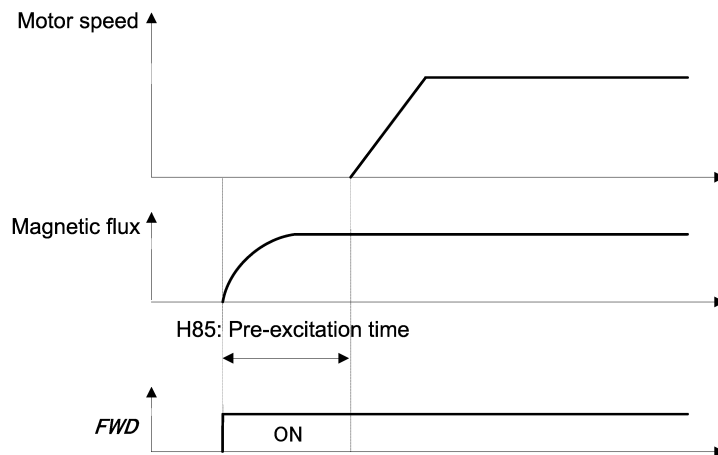

■ Pre-excite --EXITE (E01 to E07, data = 32)

Turning this input signal ON starts pre-excitation.

After the delay time for establishing magnetic flux has elapsed, a run command is inputted. Inputting the run command terminates pre-excitation and starts acceleration.

Use an external sequence to control the time for establishing magnetic flux.

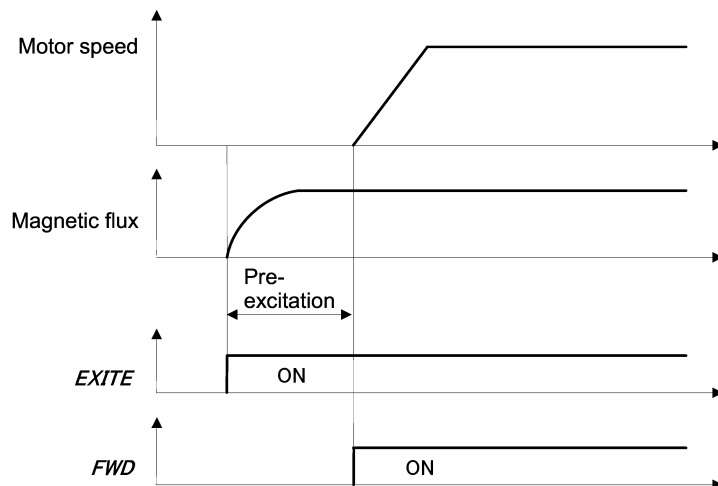

Note Under V/f control (including auto torque boost and torque vector), pre-excitation is disabled, so use DC braking or hold the starting frequency instead.

Note A transient phenomenon, which may occur when the losses of the machinery (load) are small, may make the motor rotate during pre-excitation. If the motor rotation during pre-excitation is not allowed in your system, install a mechanical brake or other mechanism to stop the motor.

⚠ WARNING

Even if the motor stops due to pre-excitation, voltage is output to inverter's output terminals [U], [V], and [W].

An electric shock may occur.

H89**Electronic thermal overload protection for motor – data retention**

When the electronic thermal overload protection for motor is used, whether to clear the cumulative value of the thermal by inverter power-off or retain the value after power-off can be specified.

Data for H89	Function
0	Clears cumulative value of thermal by inverter power-off.
1	Retains cumulative value of thermal after inverter power-off (factory default).

H86, H90**Reserved for particular manufacturers**

H86 and H90 are reserved for particular manufacturers. Unless otherwise specified, do not access these function codes.

H91**PID feedback wire break detection**

Using the terminal [C1] (C1 function) (current input) for PID feedback signal enables wire break detection and alarm (\overline{OCF}) issuance. H91 specifies whether the wire break detection is enabled, or the duration of detection. (The inverter judges an input current to the terminal [C1] below 2 mA as a wire break.)

This function does not work unless C40 is set to 0.

- Data setting range: 0.0 (Disable wire break detection)
0.1 to 60.0 s (Detect wire break and issue \overline{OCF} alarm within the time)

H92, H93**Continuous running at the momentary power failure (P, I)****(refer to F14)**

Refer to the description of F14.

H94**Cumulative motor run time 1****(refer to H78)**

Refer to the description of H78.

H95**DC braking (Braking response mode)****(refer to F20 to F22)**

Refer to the descriptions of F20 through F22.

H96**STOP key priority/Start check function**

H96 specifies a functional combination of “ STOP key priority” and “Start check function” as listed below.

H96 data	 STOP key priority	Start check function
0	Disable	Disable
1	Enable	Disable
2	Disable	Enable
3	Enable	Enable

■ **STOP key priority**

Even when run commands are entered from the digital input terminals or via the RS-485 communications link (link operation), pressing the  key forces the inverter to decelerate and stop the motor. After that, $E-r-E$ appears on the LED monitor.

■ **Start check function**

For safety, this function checks whether any run command has been turned ON or not in each of the following situations. If one has been turned ON, the inverter does not start up but displays alarm code $E-r-E$ on the LED monitor.

- When the power to the inverter is turned ON.
- When the  key is pressed to release an alarm status or when the digital input terminal command “RST” (“Reset alarm”) is turned ON.
- When the run command source is switched by a digital input terminal command such as “LE” (“Enable communications link via RS-485 or fieldbus”) or “LOC” (“Select local (keypad) operation”).

H97**Clear alarm data****Related function codes: H45 Mock alarm**

H97 clears alarm data (alarm history and relevant information) stored in the inverter.

To clear alarm data, simultaneous keying of “ key +  key” is required.

H97 data	Function
0	Disable
1	Enable (Setting “1” clears alarm data and then returns to “0.”)

H98

Protection/Maintenance function (Mode selection)

H98 specifies whether to enable or disable automatic lowering of carrier frequency, input phase loss protection, output phase loss protection, judgment threshold on the life of DC link bus capacitor, judgment on the life of DC link bus capacitor, DC fan lock detection and braking transistor error detection by setting a bit combination.

Automatic lowering of carrier frequency (Bit 0)

This function should be used for critical machinery that requires keeping the inverter running. Even if a heat sink overheat or overload occurs due to excessive load, abnormal surrounding temperature, or cooling system failure, enabling this function lowers the carrier frequency to avoid tripping (*OH1*, *OH3* or *OLU*). Note that enabling this function results in increased motor noise.

Input phase loss protection (*L_{in}*) (Bit 1)

This function detects the voltage unbalance between the phases and phase loss of 3-phase power supply. And an alarm displays *L_{in}* to stop the inverter when it detects.



In configurations where only a light load is driven or a DC reactor is connected, phase loss or line-to-line voltage unbalance may not be detected because of the relatively small stress on the apparatus connected to the main circuit.

Output phase loss protection (*OPL*) (Bit 2)

Upon detection of output phase loss while the inverter is running, this feature stops the inverter and displays an alarm *OPL*.



Where a magnetic contactor is installed in the inverter output circuit, if the magnetic contactor goes OFF during operation, all the phases will be lost. In such a case, this protection function does not work.

Judgment threshold on the life of DC link bus capacitor (Bit 3)

Bit 3 is used to select the threshold for judging the life of the DC link bus capacitor between the factory default setting and a user-defined setting.



Before specifying a user-defined threshold, measure and confirm the reference level in advance.
(Function code H42)

Judgment on the life of DC link bus capacitor (Bit 4)

Whether the DC link bus capacitor has reached its life is judged by measuring the discharging time after power OFF. The discharging time is determined by the capacitance of the DC link bus capacitor and the load inside the inverter. Therefore, if the load inside the inverter fluctuates significantly, the discharging time cannot be accurately measured. As a result, it may be mistakenly determined that the DC link bus capacitor has reached the end of its life. To avoid such an error, you can disable the judgment based on the discharging time. (Even if it is disabled, the judgment based on the "ON-time counting" while the voltage is applied to the DC link bus capacitor is performed.)



For details about the life prediction function, refer to H42.

Since load may fluctuate significantly in the cases described below, disable the judgment on the life during operation even in user-defined setting mode. During periodical maintenance, either conduct the measurement with the judgment enabled under appropriate conditions or conduct the measurement under the operating conditions matching the actual ones.

- Auxiliary input for control power is used.
- An option card is used.
- Another inverter or equipment such as a PWM converter is connected to terminals of the DC link bus.

DC fan lock detection (bit 5) (400 V class: FRN0203E2-4 or above)

The inverter may be equipped with the internal air circulation DC fan depending on the capacity. When the inverter detects that the DC fan is locked by a failure or other cause, you can select between continuing the inverter operation or making the inverter enter into the alarm state.

Entering alarm state: The inverter issues the alarm \overline{OH} and allows the motor to coast to a stop.

Continuing operation: The inverter does not enter the alarm state and continues to run the motor.

Note that, however, the inverter turns ON the “OH” and “LIFE” signals on the transistor output terminals whenever the DC fan lock is detected regardless of your selection.

Note If the ON/OFF control of the cooling fan is enabled (H06 = 1), the cooling fan may stop depending on the operating condition of the inverter. In this case, the DC fan lock detection feature is considered normal (e.g., the cooling fan is normally stopped by the stop fan command.) so that the inverter may turn OFF the LIFE or OH signal output, or enable to cancel the alarm \overline{OH} , even if the internal air circulation DC fan is locked due to a failure etc. (When you start the inverter in this state, it automatically issues the run fan command. Then the inverter detects the DC fan lock state, and turns ON the “LIFE” or “OH” output or enters the alarm \overline{OH} state.)

Note that, operating the inverter with the DC fan being locked for a long time may shorten the service life of electrolytic capacitors on the PCBs due to local high temperature inside the inverter. Be sure to check with the “LIFE” signal etc., and replace the broken fan as soon as possible.

Braking transistor error detection (Bit 6)

(\overline{dbr} FRN0072E2-4 or below, FRN0115E2-2 or below, FRN0012E2-7 or below)

Upon detection of a built-in braking transistor error, this feature stops the inverter and displays an alarm \overline{dbr} . Set data of this bit to “0” when the inverter does not use a braking transistor and there is no need of entering an alarm state.

To set data of function code H98, assign the setting of each function to each bit and then convert the 8-bit binary to the decimal number. Refer to the assignment of each function to each bit and a conversion example below.





Bit	Function	Data = 0	Data = 1	Factory default
Bit 0	Lower the carrier frequency automatically	Disable	Enable	1: Enable
Bit 1	Detect input phase loss	Continue to run	Enter alarm processing	1: Enter alarm processing
Bit 2	Detect output phase loss	Continue to run	Enter alarm processing	0: Continue to run
Bit 3	Select life judgment threshold of DC link bus capacitor	Factory default	User-defined setting	0: Factory default
Bit 4	Judge the life of DC link bus capacitor	Disable	Enable	1: Enable
Bit 5	Detect DC fan lock	Enter alarm processing	Continue to run	0: Enter alarm processing
Bit 6	Detect braking transistor breakdown	Continue to run	Enter alarm processing	0: Continue to run

Decimal and binary conversion

$$\begin{aligned}
 \text{Decimal} &= \text{Bit } 6 \times 2^6 + \text{Bit } 5 \times 2^5 + \text{Bit } 4 \times 2^4 + \text{Bit } 3 \times 2^3 + \text{Bit } 2 \times 2^2 + \text{Bit } 1 \times 2^1 + \text{Bit } 0 \times 2^0 \\
 &= \text{Bit } 6 \times 64 + \text{Bit } 5 \times 32 + \text{Bit } 4 \times 16 + \text{Bit } 3 \times 8 + \text{Bit } 2 \times 4 + \text{Bit } 1 \times 2 + \text{Bit } 0 \times 1 \\
 &= 64 + 0 \times 32 + 1 \times 16 + 0 \times 8 + 0 \times 4 + 1 \times 2 + 1 \times 1 \\
 &= 64 + 16 + 2 + 1 \\
 &= 83
 \end{aligned}$$

H99, H197, H198 H199	Password 2 setting/check User password 1 (selection of protective operation, setting check) User password protection valid
-------------------------------------	---

The password function is the function to hide the function code entirely/partially which is set for the inverter. When this function is used, perform correct settings after familiarizing yourself with the following details. If incorrect settings are made, the function code cannot be changed or checked. An alarm may also occur and the inverter may stop. Perform the operation carefully.

- 
If the objective is to prevent inadvertent rewriting of the setting value from the touch panel, it is recommended to use the data protective function with function code F00 rather than the password function. For details of the data protection, refer to the items in F00.
- 
If a password is inadvertently set, the setting values cannot be changed from the remote touch panel, multi-function touch panel or external device using the link function. Be careful for setting.
- 
If an incorrect password setting value is entered and you failed to decode the password, the password protection state cannot be released. In addition, failure to decode the password consecutively 5 times results in minor failure $\angle -P_L$.
- 
To prevent the password decoding by an ill-disposed third party, failure to decode the password for the specified number of times results in $\angle O^L$ alarm, which disables the inverter operation. Therefore, it is recommended to decode the password during stop of the system. If it is necessary to decode the password during operation, perform decoding carefully.
- 
We are not able to know the passwords set by customers. If you have forgotten the password setting value, the only way to decode the password is initialization of the function code. Set and control the password carefully.

■ Password 1 (Rewrite disable protection)

Function code setting values excluding some codes can be protected as rewrite disable.

Select the target function code which is protected by H197 and set the password (hexadecimal 4 digits) with function code H198. When function code H199 is set to 1, password 1 protective status (rewrite disable protection) is active.

■ Temporary decoding of password 1 (rewrite disable protection)

When password 1 protective status is shown and the same value as the password set for function code H198 is entered in H198, password 1 protective status is temporarily released and the function code setting value can be rewritten.

If password 2 is set at the same time, it is necessary to decode password 2 with H99 in advance.

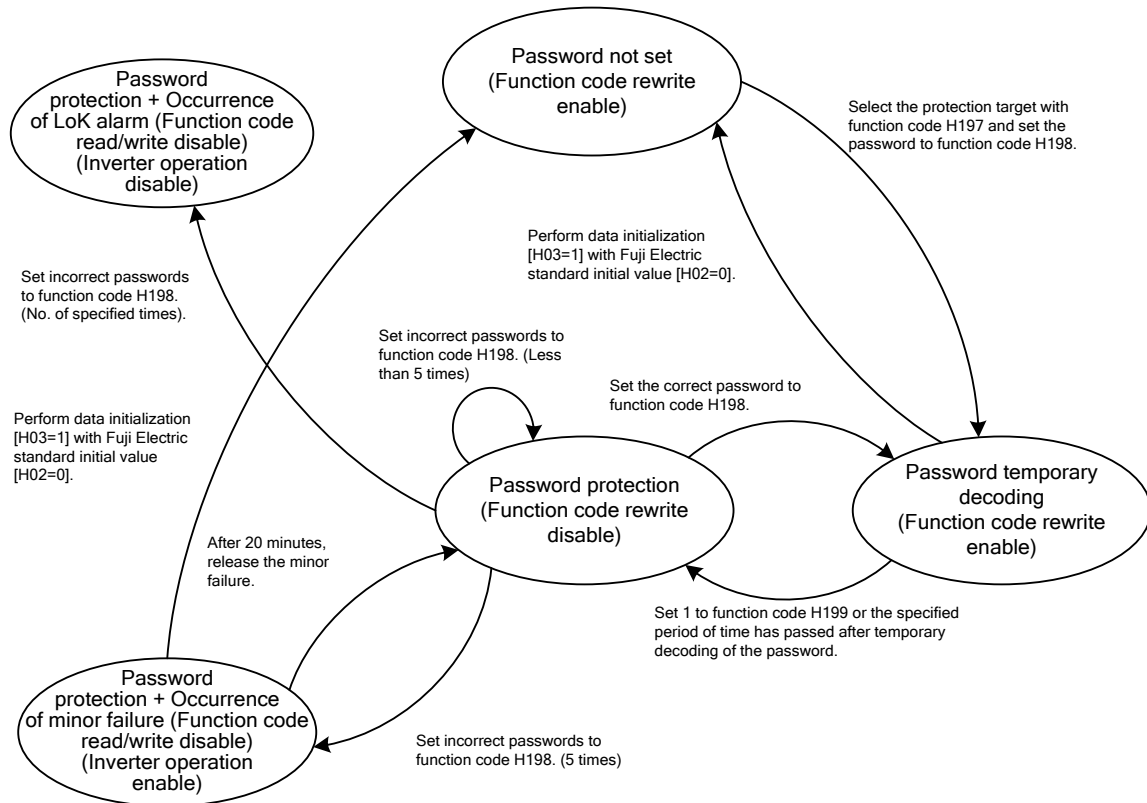

Figure 5.3-12 Relation chart of password 1 protection status

■ Password 2 (Read/write disable protection)

Setting values of all function codes not by selecting function code H197 can be protected as read disable and rewrite disable. (Exceptionally, partial function codes are not protected.)

Set the password with function code H99 and set function code H199 to 1. Password 2 protective status (read/write disable protection) is active.

The function code of read/write disable does not allow writing of the setting value to the inverter with a remote touch panel, multi-function touch panel or external device using serial communication, or reading of the setting value.

■ Temporary decoding of password 2 (read/write disable protection)

When password 2 protective status is shown and the same value as the password (hexadecimal 4 digits) set for function code H99 is entered in H99, password 2 protective status is temporarily decoded and the function code value can be read and it can be displayed on the touch panel.

If password 1 protection (rewrite disable protection) is also set, the function code can be rewritten by temporarily decoding password 1 protective status continuously.

■ Failure of temporary decoding of passwords 1 and 2

In password 1 protective status or password 2 protective status, if the password value entered in function code H198 or H99 is incorrect when trying to temporarily cancel the protective status, temporary decoding is disabled.

In both function codes H198 and H99, 5 consecutive failures of password input result in minor failure \mathcal{L} -FL.

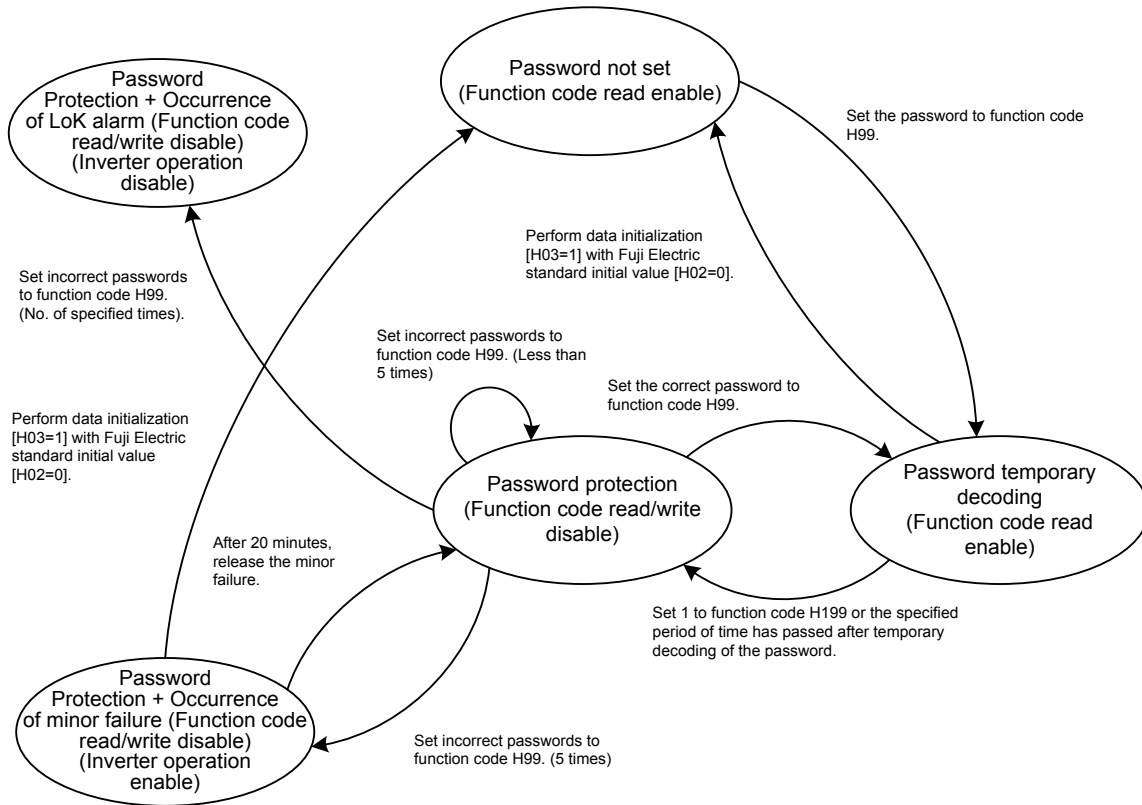

Figure 5.3-13 Relation chart of password 2 protection status



In our factory default status, passwords are not provided excluding special products. Therefore, if the password set for H198 or H99 is unknown or forgotten, we do not answer or inform you of the password or its decoding method from protective status.

For this reason, set and control the password at your own risk. If a password is set at the delivery of the product and its decoding is required, please contact the dealer you purchased or the unit manufacturer. (We are not able to know the passwords set by customers.)

■ Setting passwords 1 and 2 with multi-function touch panel and temporary decoding

Setting or temporary decoding of passwords 1 and 2 using the multi-function touch panel is performed by the special menu on the multi-function touch panel. Therefore, function codes H99, H198 and H199 are not displayed on the function code list of the function code setting menu or function code check menu on the multi-function touch panel (H197 is displayed).



For the special password menu of the multi-function touch panel, refer to the instruction manual of the multi-function touch panel.

H101	Destination
-------------	--------------------

Refer to Chapter 4 “4.4 Destination Setting”.

H111	UPS operation Level
-------------	----------------------------

Refer to the description of “■UPS operation” in E01 to E05.

- Data setting range: 120 to 220 VDC: (200 V class), 240 to 440 VDC: (400 V class)

H114	Anti-regenerative control (Level)	Related function code: H69
-------------	--	-----------------------------------

Allows the adjustment of the level when anti-regenerative control by torque limiter is performed with H69 = 2, 4. Basically, there is no need to modify the setting.

Data for H114	Function
0.0 to 50.0%	Adjusted level: Increasing the value increases the frequency operation.
999	Standard level

H147	Speed control (Jogging) (FF Gain)
-------------	--

Refer to the description of d01 to d08.

H154	Torque bias (Mode selection)
H155 to H157	Torque bias (Level 1 to 3)
H158	Torque bias (Mechanical loss compensation)
H159	Torque bias (Startup timer)
H161	Torque bias (Shutdown timer)
H162	Torque bias (Limiter)

Torque bias value is added to the torque command (the output of ASR) before the torque limiter value. The torque bias level can be selected from the analog input value or the three fixed values which are specified with function codes and switched by the digital input signals “TB1” and “TB2”. For block diagram for control logic, refer to Chapter 8, Figure 8.6-5.

The direction of run command and the polarity of the torque bias determine the mode of drive operation (driving/braking). Refer to the figure below.

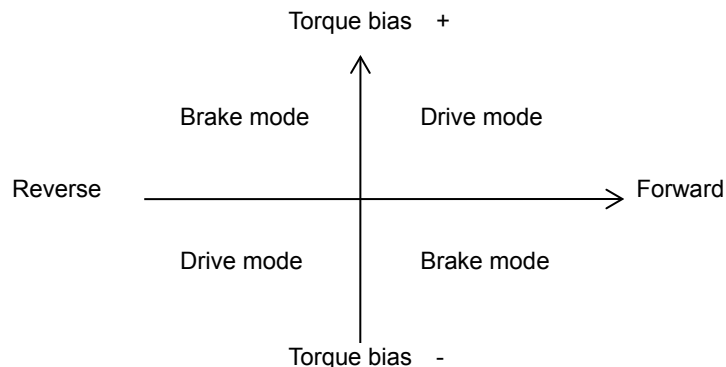

■ Modes select (H154)

This function allows to select the method of torque bias input.

H154 data	Function
0	Disable torque bias (factory default)
1	Enable levels 1,2 and 3 selected by digital inputs “TB1”, “TB2”.
2	Enable analog input value.

■ Set level 1, 2 and 3 (H155 to H157); Select torque bias 1, 2 -- “TB1”, “TB2” (E01 to E05 data = 61, 62)

The combination of the ON/OFF states of digital input signals “TB1” and “TB2” selects one of 3 different torque-bias levels defined beforehand by the 3 function codes H155 to H157 (Torque-bias level 1, level 2 and level 3). These functions cannot be changed during running.

Set level 1, 2 and 3 data setting range: -300.00 to 300.00 (%)

input signals		Torque-bias to be selected
“TB2”	“TB1”	
OFF	OFF	Disable torque-bias
OFF	ON	H155 Torque-bias level 1
ON	OFF	H155 Torque-bias level 2
ON	ON	H155 Torque-bias level 3

■ Mechanical loss compensation (H158)

Use this function compensate the amount of the mechanical loss of a load.

- Data setting range: 0 to 300.00 (%) of a motor rated torque

■ Torque-bias hold command -- “H-TB” (E01 to E05 data = 62)

Turning this terminal command ON enables a torque-bias hold command. This command directs to preserve the torque-bias data supplied via an analog input.

■ Startup timer (H159)

H159 is the time to increase the bias torque from 0 to 100% of the motor rated torque.

Use this function for adjusting the release timing of the mechanical brake control at zero speed.

If this function code is set to “0.00”, the torque bias is activated immediately.

- Data setting range: 0.00 (Factory default) to 1.00 (s)

■ Shutdown timer (H161)

H161 is the time which is defined to decrease the bias torque from 100 to 0% of the motor rated torque.

Use this function for adjusting the apply timing of the mechanical brake control at zero speed.

- Data setting range: 0.00(factory default) to 1.00 (s)

■ Limiter (H162)

This function code can be applied to limit the torque bias for protection when the load sensor has failed. The absolute value of the torque bias is limited by setting the value of the function code H162.

- Data setting range: 0 to 200 (%) (Factory default)

H173**Magnetic flux level at light load**

This function decreases the motor magnetic flux at light load and can reduce the motor noise. It is only available under vector control with speed sensor.

The motor magnetic flux command is controlled in proportion to torque current command that is less than 50%. H173 specifies the minimum value of the flux command. Refer to the figure below.

- Data setting range: 10 to 100(%) (factory default)

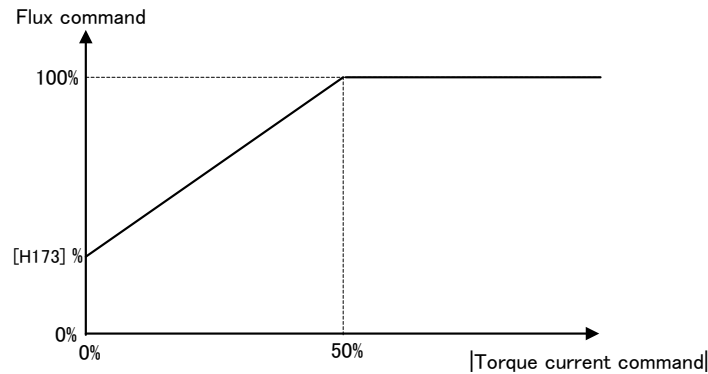
**H180****Brake control signal (Check-timer for brake operation) Related function code: J68 to J72**

Refer to the description of J68.

H195**DC braking (Braking timer at the startup)****Related function code: F21**

DC braking can be activated at startup. For details, refer to the description of F21.

5.3.6 A codes (Motor 2 parameters)

FRENIC-Ace allows to switch between 2 motors for operation using the same inverter.

Function code	"M2"	Motor to drive	Remarks
F/E/P and other codes	OFF	Motor 1	Including function codes commonly applied to motors 1 to 2.
A codes	ON	Motor 2	Induction motor control only.

Note This manual describes function codes applied to motor 1 only. For ones applied to motor 2, refer to the corresponding function codes for motor 1 in Table 5.3-19.

If turned ON M2 accidentally while driving a PMSM, it will be driven as induction motor. There is a risk of an accident.

When motor switching is specified, the function codes in Table 5.3-19 are switched. Note that the functions listed in Table 5.3-20 are for motor 1 only and not available when the motor 2 is selected. However, they can be enabled with A98.

Table 5.3-19 Function Codes to be Switched

Name	Function code	
	1st motor	2nd motor
Maximum frequency	F03	A01
Base frequency	F04	A02
Rated voltage at base frequency	F05	A03
Maximum output voltage	F06	A04
Torque boost	F09	A05
Electronic thermal overload protection for motor (Select motor characteristics)	F10	A06
(Overload detection level)	F11	A07
(Thermal time constant)	F12	A08
DC braking (Braking starting frequency)	F20	A09
(Braking level)	F21	A10
(Braking time)	F22	A11
Starting frequency	F23	A12
Load selection / Auto torque boost/ Auto energy saving operation	F37	A13
Drive control selection	F42	A14
Motor parameters (No. of poles)	P01	A15
(Rated capacity)	P02	A16
(Rated current)	P03	A17
(Auto-tuning)	P04	A18
(Online tuning)	P05	A19
(No-load current)	P06	A20
(%R1)	P07	A21
(%X)	P08	A22
(Slip compensation gain for driving)	P09	A23
(Slip compensation response time)	P10	A24
(Slip compensation gain for braking)	P11	A25
(Rated slip frequency)	P12	A26

Table 5.3-19 Function Codes to be Switched (cont'd)

Name	Function code	
	1st motor	2nd motor
(Iron loss factor 1)	P13	A27
(Magnetic saturation factor 1 to 5)	P16 to P20	A30 to A34
(%X correction factor 1)	P53	A53
(Torque current under vector control)	P55	A55
(induced voltage factor under vector control)	P56	A56
Speed control (Speed command filter)	d01	A43
(Speed detection filter)	d02	A44
(P Gain)	d03	A45
(Integral time)	d04	A46
(FF Gain)	d05	A47
(Notch filter resonance frequency)	d07	A49
(Notch filter attenuation level)	d08	A50
Motor selection	P99	A39
Slip compensation (Operating conditions)	H68	A40
Output current fluctuation damping gain for motor	H80	A41
Cumulative motor run time	H94	A51
Startup count for motor	H44	A52
Reserved for particular manufacturers	d51	d52

Table 5.3-20 Function Codes not available for the Motor 2

Data	Function codes	2nd motor operation
Non-linear V/f pattern	H50 to H53, H65, H66	Disabled
Starting frequency 1 (Holding time)	F24	Disabled
Stop frequency (Holding time)	F39	Disabled
Motor overload early warning	E34, E35	Disabled
Droop control	H28	Disabled
UP/DOWN control	H61	Fixed at the initial setting (0 Hz)
PID control	J01 to J06, J08 to J13, J15 to J19 J56 to J62, J105 to J138, H91	Disabled
Brake signal	J68 to J72, J95, J96	Disabled
Current limiter	F43, F44	Disabled
Rotational direction limitation	H08	Disabled
Maintenance Interval/ Preset startup count for maintenance	H78, H79	Disabled
DC braking (Braking timer at the startup)	H195	Disabled
PMSM drive	F42	Disabled

A98**Motor 2 (Function selection)**

Setting range: 0000 to FFFF (hexadecimal)

Among the functions disabled for motor 2 shown in Table 5.3-20, function A98 allows to enable the functions below.

Bit	Function	Data = 0	Data = 1	Factory default
Bit 0	Current limitation	Disabled	Enabled	0: Disabled
Bit 1	Rotational direction limitation	Disabled	Enabled	0: Disabled
Bit 2	Non-linear V/f	Disabled	Enabled	0: Disabled
Bit 3	PID control	Disabled	Enabled	0: Disabled
Bit 4	Brake signal	Disabled	Enabled	0: Disabled
Bit 5	DC braking at start-up	Disabled	Enabled	0: Disabled
Bit 6 to 15	No function assigned	—	—	—

5.3.7 b, r codes (Speed control 3 and 4 parameters)

FRENIC-Ace has four sets of speed control parameter. They can be selected by “MPRM1”, “MPRM2” signals. For the description of speed control parameters, refer to function code d01.

Name	Speed control parameter sets			
	set1	set2	set3	set4
Speed control (Speed command filter)	d01	A43	b43	r43
(Speed detection filter)	d02	A44	b44	r44
(P gain)	d03	A45	b45	r45
(Integral time)	d04	A46	b46	r46
(FF Gain)	d05	A47	b47	r47
(Notch filter resonance frequency)	d07	A49	b49	r49
(Notch filter attenuation level)	d08	A50	b50	r50

■ Select speed control parameter 1, 2 -- “MPRM1”, “MPRM2” (E01 to E05 data = 78, 79)

The combination of the ON/OFF states of digital input signals “MPRM1” and “MPRM2” selects one among 4 different speed control parameter sets .

input signals		Selected speed control parameter set
“MPRM2”	“MPRM1”	
OFF	OFF	d01 to d08 speed control parameter set1
OFF	ON	A43 to A50 speed control parameter set2
ON	OFF	b43 to b50 speed control parameter set3
ON	ON	r43 to r50 speed control parameter set4

5.3.8 J codes (Applied functions)

J01	PID control (Mode selection)
-----	------------------------------

Under PID control, the inverter detects the state of a control target object with a sensor or similar device and compares it with the commanded value (e.g., temperature control command). If there is any deviation between them, PID control operates so as to minimize it. That is, it is a closed loop feedback system that matches a controlled variable (feedback amount).

PID control expands the application area of the inverter to process control (e.g., flow control, pressure control, and temperature control) and speed control (e.g., dancer control).

If PID control is enabled (J01 = 1, 2 or 3), the frequency control of the inverter is switched from the drive frequency command generator block to the PID command generator block.

■ Mode Selection (J01)

J01 selects the PID control mode.

J01 data	Function
0	Disable
1	Process control (normal operation)
2	Process control (inverse operation)
3	Speed control (dancer control)

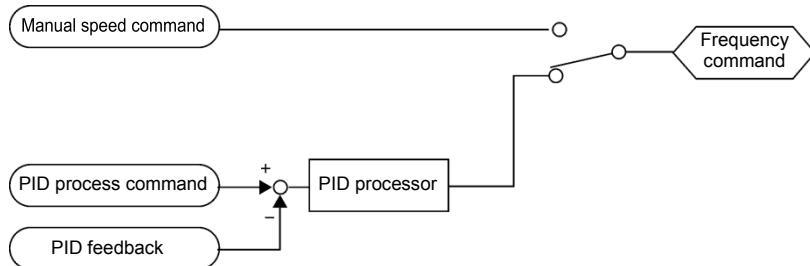

<PID process control block diagram>

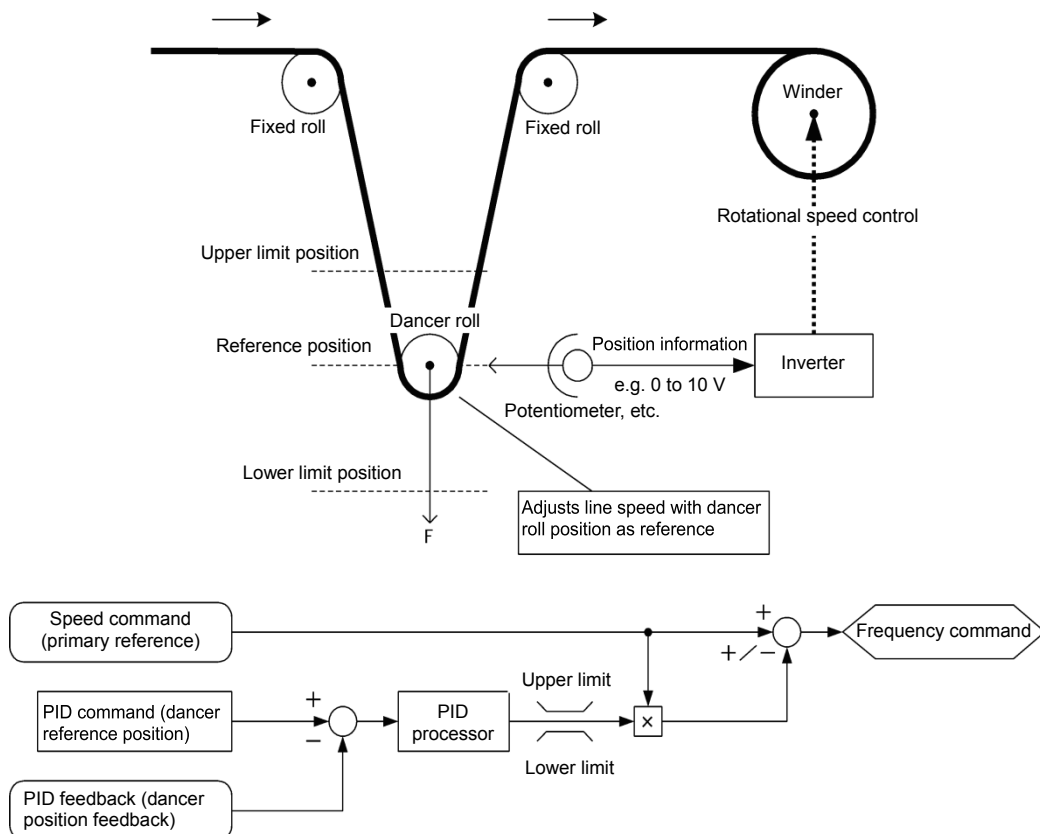

<PID dancer control block diagram>





- Using J01 allows switching between normal and inverse operations for the PID control output, so you can specify an increase/decrease of the motor rotating speed depending on the difference (error component) between the commanded (input) and feedback amounts, making it possible to apply the inverter to air conditioners. The terminal command IVS can also switch operation between normal and inverse.



 For details about the switching of normal/inverse operation, refer to the description of “ Switch normal/inverse operation – “IVS”” (E01 to E05, data = 21).

J02	PID Control (Remote command) Related function code J105: PID control (Display unit) J106: PID control (Maximum scale) J107: PID control (Minimum scale) J136 to J138: PID control multistep command 1 to 3
------------	---

J02 sets the source that specifies the command value (SV) under PID control.

J02 data	Function
0	Keypad Specify the PID command by using the  /  keys on the keypad.
1	PID command 1 (Analog input: Terminals [12], [C1] (C1 function), [C1] (V2 function)) Voltage input to the terminal [12] (0 to ±10 VDC, 100% PID command/ ±10 VDC) Current input to the terminal [C1] (C1 function) (4 to 20 mA DC, 100% PID command/ 20 mA DC) Voltage input to the terminal [C1] (V2 function) (0 to +10 VDC, 100% PID command/ +10 VDC)
3	Terminal command UP/DOWN Using the “UP” or “DOWN” command in conjunction with PID minimum scale to maximum scale (specified by J106 and J107) with which the command value is converted into a physical quantity, etc., you can specify 0 to 100% of the PID command (± 100% for PID dancer control).
4	Command via communications link Use function code S13 to specify the PID command by communications. The transmission data of 20000d (decimal) is equal to 100% (maximum set point value) of the PID command.

[1] PID command with the / keys on the keypad (J02 = 0, factory default)

Using the  /  keys on the keypad in conjunction with PID minimum / maximum scale (specified by J106 and J107), you can specify 0 to 100% of the PID command (±100% for PID dancer control) in an easy-to-understand, converted command format.

For details of operation, refer to Chapter 3 “3.3.5 Setting up PID commands from the keypad.”

[2] PID command by analog inputs (J02 = 1)

When any analog input (voltage input to terminals [12] and [C1] (V2 function), or current input to terminal [C1] (C1 function)) for PID command 1 (J02 = 1) is used, it is possible to arbitrary specify the PID command by multiplying by the gain and adding the bias. The polarity can be selected and the filter time constant and offset can be adjusted. In addition to J02 setting, it is necessary to select PID process command 1 for analog input (specified by any of E61 to E63, function code data = 3). For details, refer to the descriptions of E61 to E63.

Table 5.3-21 Adjustable elements of PID command

Input terminal	Input range	Bias		Gain		Polarity	Filter	Offset
		Bias	Base point	Gain	Base point			
[12]	0 to +10V, -10 to +10V	C55	C56	C32	C34	C35	C33	C31
[C1] (C1)	4 to 20mA, 0 to 20mA	C61	C62	C37	C39	C40	C38	C36
[C1] (V2)	0 to +10V	C67	C68	C42	C44	C45	C43	C41

■ Offset (C31, C36, C41)

C31, C36 or C41 configure the offset for an analog voltage/current input.

■ Filter (C33, C38, C43)

C33, C38, and C43 provide the filter time constants for the voltage and current of the analog input. The larger the setting of time constant is, the slower the response is. Specify the proper filter time constant taking into account the response speed of the machine (load). If an analog input signal fluctuates due to line noises, increase the filter time constant.

■ Polarity selection for terminal [12] (C35)

C35 configures the input range for analog input voltage of terminal [12].

C35 data	Modes for terminal inputs
0	-10 to +10V
1	0 to +10 V(negative value of voltage is regarded as 0 V)

■ Range / polarity selection for terminal [C1] (C1 function) (C40)

C40 configures the input range for analog input current of terminal [C1] (C1 function).

C40 data	Range of terminal inputs	Handling when a bias value is configured as minus
0	4 to 20 mA (Factory default)	Limits any value lower than 0 to 0.
1	0 to 20 mA	
10	4 to 20 mA	Enables any value lower than 0 as minus value.
11	0 to 20 mA	

■ Polarity selection for terminal [C1] (V2 function) (C45)

C45 configures the input range for analog input voltage of terminal [C1] (V2 function).

C45 data	Modes for terminal inputs	When bias is specified to be negative
0	0 to +10V	Makes a value lower than 0 effective as a negative value.
1	0 to +10V (factory default)	Limits a value lower than 0 to 0.

■ Gain and bias

Terminal	Data
[12]	
[C1] (C1) function	
[C1] (V2 function)	

(Example) In order to allocate for the range of 0 to 100% to the range of 1 to 5 V at terminal [12], set as follows.

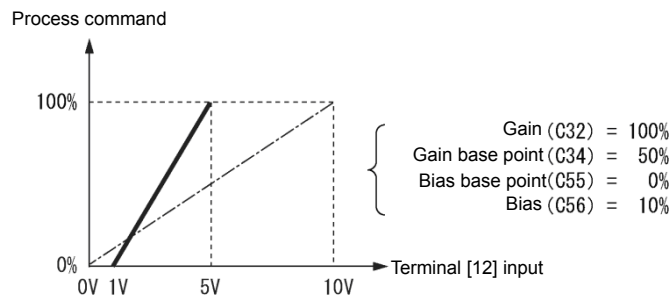

[3] PID command with UP/DOWN control (J02 = 3)

When UP/DOWN control is selected as a PID speed command, turning the terminal command “UP” or “DOWN” ON causes the PID set point value to change within the range from minimum scale to maximum scale.

The PID set point value can be specified in physical quantity units (such as temperature or pressure) with the minimum scale (J106) and maximum scale (J107).

To select UP/DOWN control as a PID set point value, the “UP” and “DOWN” should be assigned to the digital input terminals [X1] to [X5]. (📖 Function codes E01 to E05 data = 17, 18)

“UP” Data = 17	“DOWN” Data = 18	Action
OFF	OFF	Retain PID set point value.
ON	OFF	Increase PID set point value at a rate between 0.1%/0.1 s and 1%/0.1 s.
OFF	ON	Decrease PID set point value at a rate between 0.1%/0.1 s and 1%/0.1 s.
ON	ON	Retain PID set point value.

Note The inverter internally holds the PID command value set by UP/DOWN control and applies the held value at the next restart (including powering ON).

[4] PID command via communications link (J02 = 4)

Use function code S13 to specify the PID command by communications. The transmission data of 20000 (decimal) is equivalent to 100% (maximum set point value) of the PID command. For details of the communications format, refer to the RS-485 Communication User’s Manual.

- Note**
- Other than the remote command selection by J02, the PID multistep commands 1, 2 or 3 (specified by J106, J137 or J138, respectively) selected by the PID multistep commands “PID-SS1” and “PID-SS2” can also be used as preset set point values for the PID command.
 - In dancer control (J01 = 3), the setting command from the keypad is in conjunction with the function code J57 (PID control: Dancer position set point), and it is saved as function code data.

Selecting Feedback Terminals

For feedback control, determine the connection terminal according to the type of the sensor output.

- If the sensor is a current output type, use the current input terminal [C1] (C1 function) of the inverter.
- If the sensor is a voltage output type, use the voltage input terminal [12] of the inverter, or switch over the terminal [C1] (V2 function) to the voltage input terminal and use it.

📖 For details, refer to the descriptions of E61 to E63.

<Application example: Process control> (for air conditioners, fans and pumps)

The operating range for PID process control is internally controlled as 0% through 100%. For the given feedback input, determine the operating range to be controlled by means of gain adjustment.

Example: When the external sensor has the output range of 1 to 5 V:

- Use terminal [12] as the input terminal in voltage.
- Set the gain (C32 for analog input adjustment) to 200% in order to make 5V of the maximum output of the external sensor to be 100% of input scale.

For the input specification of terminal 12, 0-10V is equivalent to 0-100%. Therefore the gain has to be set 200% (= 10 V / 5 V *100). Note also that any bias setting does not apply to feedback control.

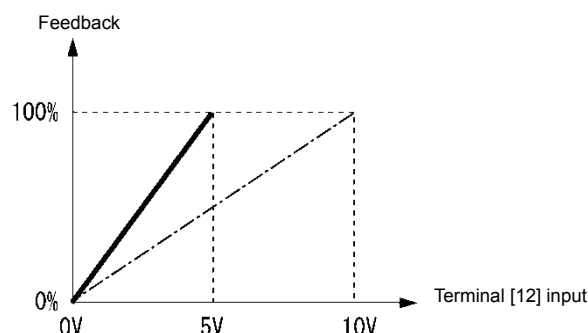

<Application examples: Dancer control> (for winders)

Example 1: When an external sensor has the output range of -7 to +7 VDC:

- Use terminal [12] as the input terminal in voltage.
- When the external sensor has ± 7 VDC of bipolar output, inside the inverter ± 7 VDC should be equivalent to $\pm 100\%$. To convert ± 7 VDC from the output of an external sensor to $\pm 100\%$, the gain (C32 for analog input adjustment) has to be set 143% ($\approx 10 \text{ V} / 7 \text{ V} * 100$).

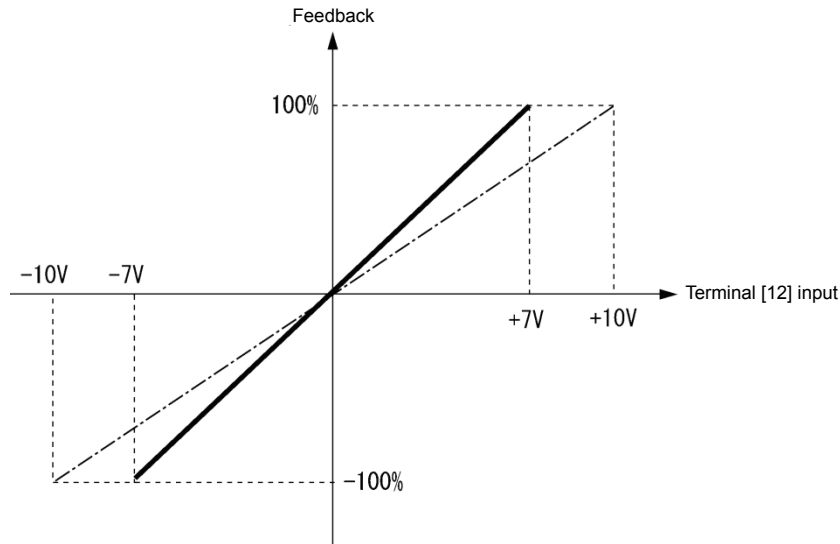

Example 2: When an external sensor has the output range of 0 to 10 VDC:

- Use terminal [12] as the input terminal in voltage.
- When the external sensor has unipolar output, inside the inverter it is controlled within the range of 0 to 100%.

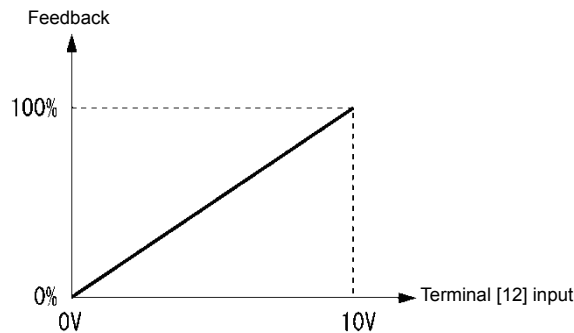

In this example, it is recommended that the dancer reference position is set around the 5 V (50%) point.

PID display coefficient and Monitoring

To monitor the PID command and its feedback value, set the scale to convert the values into easy-to-understand physical quantities such as temperature. The display unit is invalid on the standard keypad (TP-M2). The display unit is used with the multi-function keypad (TP-A1-E2C).

	Display unit	Maximum scale	Minimum scale
Terminal [12]	C58	C59	C60
Terminal [C1] (C1)	C64	C65	C66
Terminal [C1] (V2)	C70	C71	C72

 Refer to function codes C59, C60, C65, C66, C71 and C72 for details on scales, and to E43 for details on monitoring.

■ Display unit (J105)

J105 can select the display units for monitoring PID feedback value with the multi-function keypad (TP-A1-E2C). Setting "0" selects the factory default unit for the PID feedback value.

J105	Display unit	J105	Display unit	J105	Display unit
0	* (Factory default)	23	L/s (flow)	45	mmHg (pressure)
1	No unit	24	L/min (flow)	46	Psi (pressure)
2	%	25	L/h (flow)	47	mWG (pressure)
4	r/min	40	Pa (pressure)	48	inWG (pressure)
7	kW	41	kPa (pressure)	60	K (temperature)
20	m ³ /s (flow)	42	MPa (pressure)	61	°C (temperature)
21	m ³ /min (flow)	43	mbar (pressure)	62	°F (temperature)
22	m ³ /h (flow)	44	bar (pressure)	80	ppm (density)

* The unit and scale for feedback values are used.

■ Maximum scale/minimum scale (J106, J107)

The PID control values can be converted to a physical quantity that is easy to recognize and displayed accordingly. Set the maximum scale "PID command value/ display for 100% of a PID feedback value" with J106 and the minimum scale "PID command value/ display for 0% of a PID feedback value" with J107

The displayed value is determined as follows:

Display value = (PID command value (%)) / 100 * (Max. scale - Min. scale) + Min. scale

- Data setting range: (Max. scale and min. scale) -999.00 to 0.00 to 9990.00

■ PID multistep command 1 to 3 (J136, J137 and J138)

A PID command value can be given by the PID multistep command and selected by digital inputs programmed with "PID-SS1" and "PID-SS2" functions. Assign the digital input terminals with "PID-SS1" and "PID-SS2" (📖Function codes E01 to E05, data =171 and 172 respectively).

PID-SS2	PID-SS1	PID multistep command
OFF	OFF	Not selected
OFF	ON	J136: PID multistep command 1 setting range: -999.0 to 0.00 to 9990
ON	OFF	J137: PID multistep command 2 setting range: -999.0 to 0.00 to 9990
ON	ON	J138: PID multistep command 3 setting range: -999.0 to 0.00 to 9990

J03 to J06

PID Control P (Gain), I (Integral time), D (Differential time), Feedback filter

■ P gain (J03)

J03 specifies the proportional gain for the PID processor.

- Data setting range: 0.000 to 30.000 (times)

P (Proportional) action

An operation in which the MV (manipulated value: output frequency) is proportional to the deviation is called P action, which outputs the MV in proportion to deviation. However, P action alone cannot eliminate deviation.

Gain is data that determines the system response level against the deviation in P action. An increase in gain speeds up response, but an excessive gain may oscillate the inverter output. A decrease in gain delays response, but it stabilizes the inverter output.

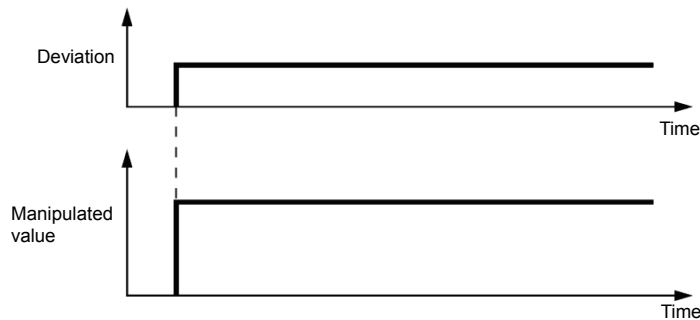

■ I integral time (J04)

J04 specifies the integral time for the PID processor.

- Data setting range: 0.0 to 3600.0 (s)
0.0 indicates that the integral component is ineffective

I (Integral) action

An operation in which the change rate of the MV (manipulated value: output frequency) is proportional to the integral value of deviation is called I action, which outputs the MV that integrates the deviation. Therefore, I action is effective in bringing the feedback value close to the commanded value. For the system whose deviation rapidly changes, however, this action cannot make it respond quickly.

The effectiveness of I action is expressed by integral time as parameter, that is J04 data. The longer the integral time, the slower the response. The reaction to the external disturbance also becomes slow. The shorter the integral time, the faster the response. Setting too short integral time, however, makes the inverter output tend to oscillate against the external disturbance.

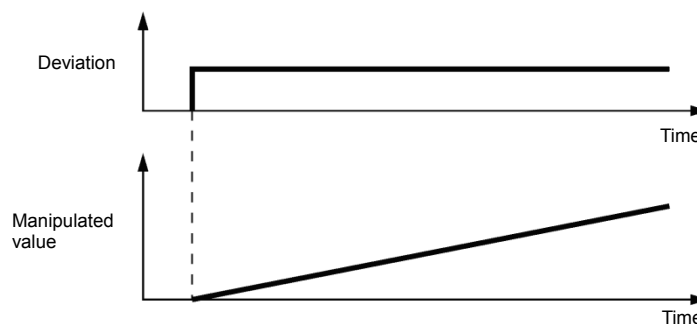

■ D differential time (J05)

J05 specifies the differential time for the PID processor.

- Data setting range: 0.00 to 600.00 (s)
0.00 indicates that the differential component is ineffective.

D (Differential) action

An operation in which the MV (manipulated value: output frequency) is proportional to the differential value of the deviation is called D action, which outputs the MV that differentiates the deviation. D action makes the inverter quickly respond to a rapid change of deviation.

The effectiveness of D action is expressed by differential time as parameter, that is J05 data. Setting a long differential time will quickly suppress oscillation caused by P action when a deviation occurs. Too long differential time makes the inverter output oscillation more. Setting short differential time will weaken the suppression effect when the deviation occurs.

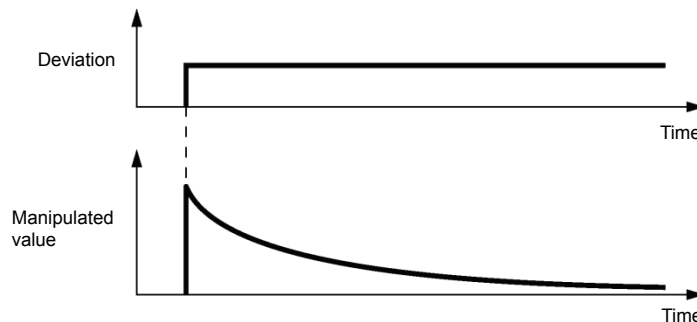

The combined uses of P, I, and D actions are described below.

(1) PI control

PI control, which is a combination of P and I actions, is generally used to minimize the remaining deviation caused by P action. PI control always acts to minimize the deviation even if a commanded value changes or external disturbance steadily occurs. However, the longer the integral time of I action, the slower the system response to quick-changed control. P action can be used alone for loads with very large part of integral components.

(2) PD control

In PD control, the moment that a deviation occurs, the control rapidly generates greater MV (manipulated value: output frequency) than that generated by D action alone, to suppress the deviation increase. When the deviation becomes small, the behavior of P action becomes small. A load including the integral component in the controlled system may oscillate due to the action of the integral component if P action alone is applied. In such a case, use PD control to reduce the oscillation caused by P action, for keeping the system stable. That is, PD control is applied to a system that does not contain any damping actions in its process.

(3) PID control

PID control is implemented by combining P action with the deviation suppression of I action and the oscillation suppression of D action. PID control features minimal control deviation, high precision and high stability. In particular, PID control is effective to a system that has a long response time to the occurrence of deviation.

Follow the procedure below to set data to PID control function codes.

It is highly recommended that you adjust the PID control value while monitoring the system response waveform of the PID feedback with an oscilloscope or equivalent. Repeat the following procedure to determine the optimal solution for each system.

- Increase the data of J03 (PID control P (Gain)) within the range where the feedback signal does not oscillate.
- Decrease the data of J04 (PID control I (Integral time)) within the range where the feedback signal does not oscillate.
- Increase the data of J05 (PID control D (Differential time)) within the range where the feedback signal does not oscillate.

The method for refining the system response from the waveforms is shown below.

1) Suppressing overshoot

Increase the data of J04 (Integral time) and decrease that of J05 (Differential time).

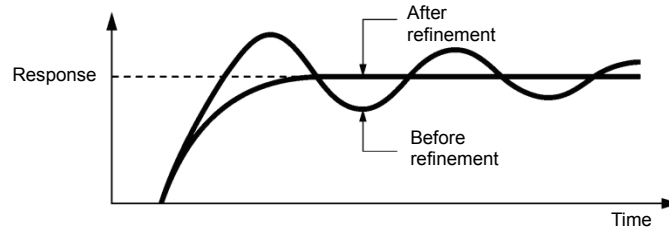

2) Quick stabilizing (Moderate overshoot is allowable.)

Decrease the data of J03 (Gain) and increase that of J05 (Differential time).

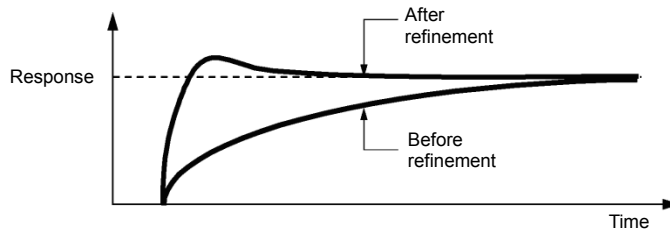

3) Suppressing oscillation whose period is longer than the integral time specified by J04

Increase the data of J04 (Integral time).

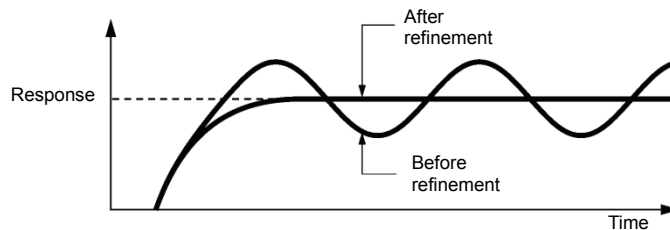

4) Suppressing oscillation whose period is approximately the same as the time specified by J05 (Differential time)

Decrease the data of J05 (Differential time).

Decrease the data of J03 (Gain), if the oscillation cannot be suppressed even though the differential time is set at 0 sec.

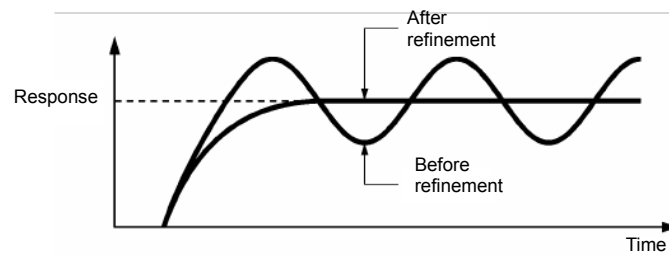

■ Feedback filter (J06)

J06 specifies the time constant of the filter for feedback signals under PID control.

- Data setting range: 0.0 to 900.0 (s)
- This setting is used to stabilize the PID control loop. Setting a too long time constant makes the system response slow.

Note Under PID dancer control, the filter time constant setting of up to 0.1 s is recommended. To specify the filter time constant more finely, apply filter time constants for analog input (C33, C38 and C43) with J06 = 0.0.

J10	PID Control (Anti-reset windup)
------------	--

J10 suppresses overshoot in control with the PID processor. As long as the error between the feedback and the PID command is beyond the preset range, the integrator holds its value and does not perform integration operation.

- Data setting range: 0 to 200 (%)

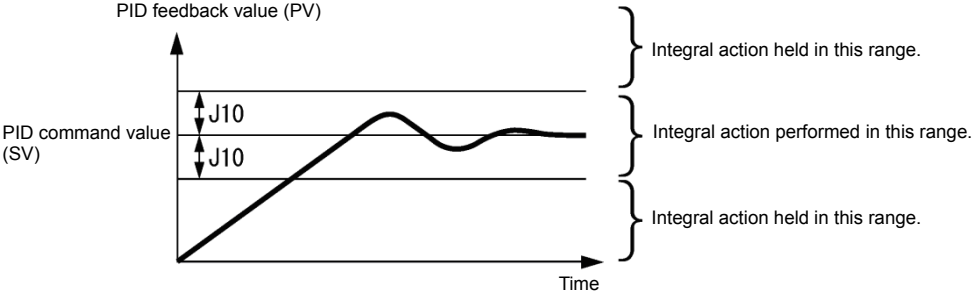

J11 to J13	PID Control (Select warning output, Upper limit of warning (AH) and Lower limit of warning (AL))
-------------------	---

The inverter can output two types of warning signals (caused by process command value or PID error value) associated with PID control if the digital output signal “PID-ALM” is assigned to any of the programmable, output terminals with any of E20, E21 and E27 (data = 42).

J11 specifies the warning output types. J12 and J13 each specify the upper and lower limits for warnings.

■ **PID Control (Select warning output) (J11)**

J11 specifies one of the following alarms available.

J11 data	Alarm	Data
0	Warning caused by process command value	While $PV < AL$ or $AH < PV$, “PID-ALM” is ON
1	Warning caused by process command value with hold	Same as above (with Hold)
2	Warning caused by process command value with latch	Same as above (with Latch)
3	Warning caused by process command value with hold and latch	Same as above (with Hold and Latch)
4	Warning caused by PID error value	While $PV < SV - AL$ or $SV + AH < PV$, “PID-ALM” is ON.
5	Warning caused by PID error value with hold	Same as above (with Hold)
6	Warning caused by PID error value with latch	Same as above (with Latch)
7	Warning caused by PID error value with hold and latch	Same as above (with Hold and Latch)

Hold: During the power-on sequence, the alarm output is kept OFF (disabled) even when the monitored quantity is within the alarm range. Once it goes out of the alarm range, and comes into the alarm range again, the alarm is enabled.

Latch: Once the monitored quantity comes into the alarm range and the alarm is turned ON, the alarm will remain ON even if it goes out of the alarm range. To release the latch, perform a reset by using the key on keypad or turning the terminal command RST ON. Resetting can be done by the same way as resetting an alarm.

■ **PID Control (Upper limit of warning (AH)) (J12)**

J12 specifies the upper limit of warning (AH) in percentage (%) of the feedback value.

■ PID Control (Lower limit of warning (AL)) (J13)

J13 specifies the lower limit of warning (AL) in percentage (%) of the feedback value.

Note The value displayed (%) is the ratio of the upper/lower limit to the full scale (10 V or 20 mA) of the feedback amount (in the case of a gain of 100%).

Upper limit of warning (AH) and lower limit of warning (AL) also apply to the following alarms.

Alarm	Data	How to handle the warning	
		Select warning output (J11)	Data setting
Upper limit (process command)	ON when $AH < PV$	Warning caused by process command	AL = 0
Lower limit (process command)	ON when $PV < AL$		AH = 100%
Upper limit (PID error value)	ON when $SV + AH < PV$	Warning caused by PID error value	AL = 100%
Lower limit (PID error value)	ON when $PV < SV - AL$		AH = 100%
Upper/lower limit (PID error value)	ON when $ SV - PV > AL$		AL = AH
Upper/lower range limit (PID error value)	ON when $SV - AL < PV < SV + AL$	Warning caused by PID error value	A negative logic signal should be assigned to "PID-ALM".
Upper/lower range limit (process command)	ON when $AL < PV < AH$	Warning caused by process command	
Upper/lower range limit (PID error value)	ON when $SV - AL < PV < SV + AH$	Warning caused by PID error value	

J15	PID control (Sleep frequency)
J16	PID control (Sleep timer)
J17	PID control (Wakeup frequency)
J23	PID control (Wakeup level of PID error)
J24	PID control (Wakeup timer)

Sleep function (J15 to J17, J23, J24)

J15 to J17 configure the sleep function in pump control, a function that stops the inverter when the discharge pressure increases, causing the volume of water to decrease.

When the discharge pressure has increased, decreasing the reference frequency (output of the PID processor) below the sleep level (J15) for the period specified sleep timer (J16), the inverter decelerates to stop, while PID control itself continues to operate. When the discharge pressure decreases, increasing the reference frequency (output of the PID processor) above the wakeup frequency (J17), the inverter resumes operation.

The restarting conditions can be adjusted with J23 and J24.

■ **PID control (Sleep frequency) (J15)**

J15 specifies the frequency which triggers slow flowrate stop of inverter.

■ **PID control (Sleep timer) (J16)**

J16 specifies the period from when the PID output drops below the frequency specified by J15 until the inverter starts deceleration to stop.

■ **PID control (Wakeup frequency) (J17)**

J17 specifies the wakeup frequency. Set J17 to a frequency higher than the sleep frequency (J15). If the specified wakeup frequency is lower than the sleep frequency, the sleep frequency is ignored; the sleep function is triggered when the output of the PID processor drops below the specified wakeup frequency.

■ **Assignment of “PID-STP” (“Under sleep mode of PID control”) (E20, E21 and E27, data = 44)**

“PID-STP” (“Under sleep mode of PID control”) is ON when the inverter is in a stopped state due to the sleep function under PID control. PID-STP should be assigned if it is necessary to output a signal to indicate that the inverter is stopped.

For the sleep function, see the chart below.

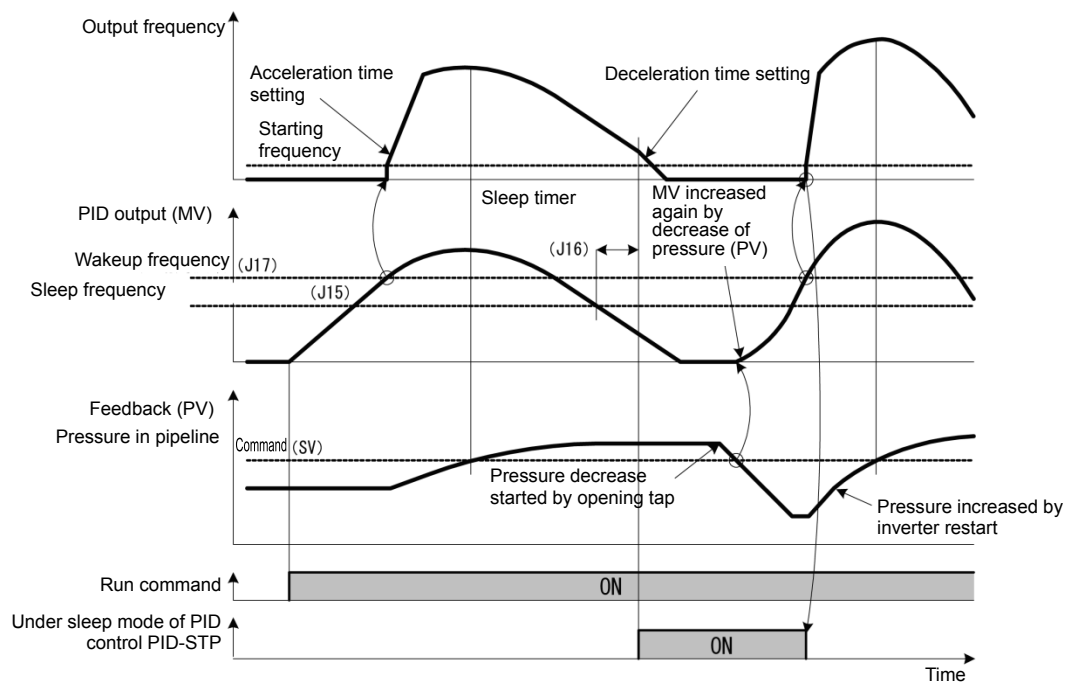

- PID control (Wakeup level of PID error) (J23)
- PID control (Wakeup timer) (J24)

When both of the two conditions below are satisfied (AND), the inverter is restarted.

- The discharge pressure has decreased, increasing the frequency (output of the PID processor) to or above the wakeup frequency (J17) and the wakeup timer (J24) has elapsed.
- The absolute error of the PV (feedback value) against to the SV (command value) is equal to or higher than the wakeup level of PID error (J23), and the wakeup time (J24) has elapsed.

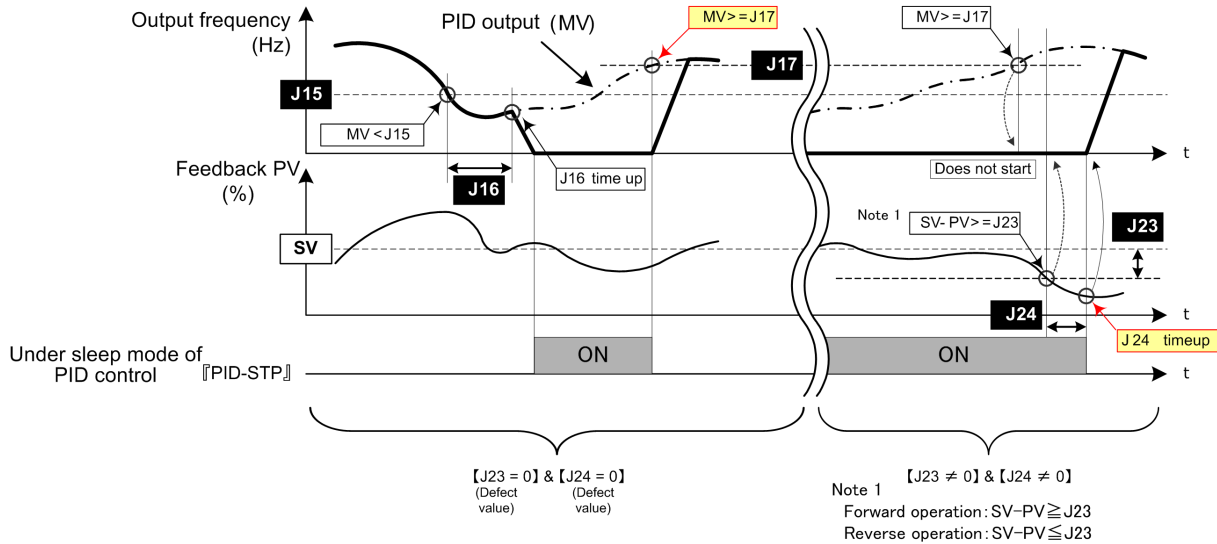

Figure 5.3-14

J18, J19 PID Control (Upper limit of PID process output, Lower limit of PID process output)

The upper and lower limiters can be specified to the PID output, exclusively used for PID control. The settings are ignored when PID cancel “Hz/PID” is enabled and the inverter is operated at the reference frequency previously specified. (Function codes E01 to E05 data = 20)

■ PID Control (Upper limit of PID process output) (J18)

J18 specifies the upper limit of the PID processor output limiter in %. If the value of “999” is specified to J18, the setting of the frequency limiter (Upper) (F15) will serve as the upper limit.

■ PID Control (Lower limit of PID process output) (J19)

J19 specifies the lower limit of the PID processor output limiter in %. If the value of “999” is specified to J19, the setting of the frequency limiter (Lower) (F16) will serve as the lower limit.

J57 PID Control (Dancer position set point)

J57 specifies the dancer position set point in the range of -100% to +100% for dancer control. If J02 = 0 (keypad) is selected, this function code is applied for the dancer position set point.

It is also possible to modify the set point (PID command) with the \uparrow / \downarrow keys on a keypad. If it is modified, the new set point value is stored as J57 data automatically.

For the setting procedure of the set point (PID command), refer to Chapter 3 “3.3.5 Setting up PID commands from the keypad.”

J58
J59 to J61

PID Control (Detection width of dancer position error)
PID Control(P (Gain) 2, I (Integral time) 2 and D (Differential time) 2)

When the feedback value of dancer roll position comes into the range of "Detection width of dancer position error (J58)" the inverter switches PID constants from the combination of J03, J04 and J05 to that of J59, J60 and J61, respectively in its PID processor. Giving a boost to the system response by raising the P gain may improve the system performance in the dancer roll positioning accuracy.

■ **PID Control (Detection width of dancer position error) (J58)**

J58 specifies the bandwidth in the range of 1 to 100%. Specifying "0" does not switch PID constants.

■ **PID Control (P (Gain) 2) (J59)**

■ **PID Control (I (Integral time) 2) (J60)**

■ **PID Control (D (Differential time) 2) (J61)**

Descriptions for J59, J60, and J61 are the same as those of PID control P (Gain) (J03), I (Integral time) (J04), and D (Differential time) (J05), respectively.

J62

PID Control (PID control block selection)

For speed control (PID dancer control), the output of the PID processor is the compensating value for the primary speed command.

It is possible to switch the polarity of the PID error to the PID dancer processor with bit 0 of J62, and also switch the output in percentage (%) of the primary speed command or in percentage (%) of the maximum frequency with bit 1 of J62.

J62 data			Block selection	
Decimal	Bit 1	Bit 0	Select the compensating value (the PID processor output) format for the primary speed command	Select the polarity of the PID error
0	0	0	In % of the primary speed command	Plus(+)
1	0	1	In % of the primary speed command	Minus(-)
2	1	0	In % of the maximum frequency	Plus(+)
3	1	1	In % of the maximum frequency	Minus(-)

[5] Overload stop function

J63 J64 J65 J66 J67	Overload stop function (Item selection) (Detection level) (Mode selection) (Operation mode) (Timer)
---------------------------------	---

Detects an overload status and if it exceeds the specified detection level (J64) for the specified timer duration (J67), the operation is stopped based on the selected action (J65). It is used to protect the system when an unacceptable overload is applied or to lock the motor shaft by mechanically hitting it to the stopper.

■ Item selection (J63)

Select a target (detected item) to monitor the load status.

J63 data	Detected value	Function overview
0	Torque	Select the driving torque as the target. To improve the accuracy of calculated torque, perform auto-tuning.
1	Current	Select the driving current as the target. The no-load current always flows to the motor. Specify J64 (Detection level) correctly considering the no-load current of the applied motor.

■ Detection Level (J64)

Set the value for overload detection level in percentage (%) of the motor rated torque or current.

■ Mode Selection (J65)

Select an operation when the load exceeds the value specified in J64.

J65 data	Action	Function overview
0	Disable	Overload stop function operation cancellation
1	Decelerate to stop	Decelerates to stop the motor, as specified in deceleration time.
2	Coast to stop	Immediately shuts down the inverter, allowing the motor to coast to a stop.

- Note**
- When the overload stop facility is enabled and an overload is detected, the inverter turns the run command OFF depending on data of the function code J65. To restart the inverter operation, turn the run command OFF, and turns it ON again.
 - This function does not work with 10% speed or less when driving PMSM.

<Mode selection J65=1, 2>

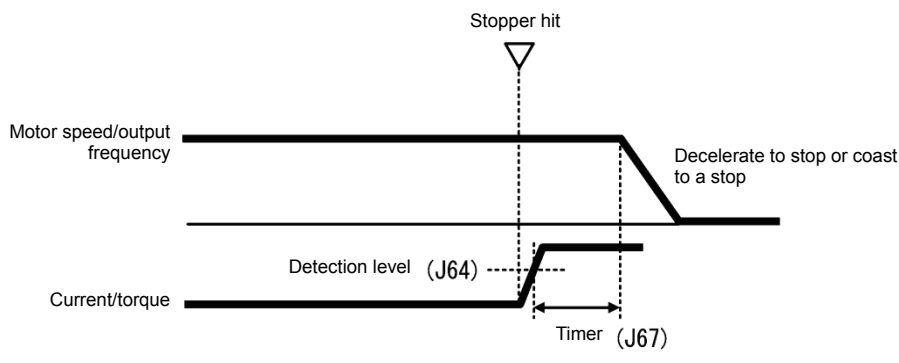

■ Operation Mode (J66)

J66 specifies the inverter's operation condition under which the overload stop function is activated.

Carefully make this setting so as not to activate the overload stop function when it is not necessary.

J66 data	Operation mode
0	Enabled during constant speed and deceleration time.
1	Enabled during constant speed
2	Enabled always

■ Timer (J67)

Apply the timer (J67) to prevent the start of the overload stop function due to the instantaneous, unintended load fluctuation. The overload stop function is activated when the operation condition has continued for specified timer J67. (if J65=1, 2).

■ Enable overload stop - "OLS" (E01 to E05 = 46)

Turning this terminal command ON enables the overload stop function; turning it OFF disables the function. If "OLS" is not assigned to any terminal, the overload stop function is always valid.

[6] Brake control signal

J68 to J70	Brake control signal (Brake-release current, Brake-release frequency/speed and Brake-release timer)
J71, J72	Brake control signal (Brake-apply frequency/speed and Brake-apply timer)
J95, J96	Brake control signal (Brake-release torque, Brake-apply conditions)
	Related function code: A98: Motor 2 (Function selection)

The brake (release/apply) control signal is useful for lift application such as a hoist. This signal is adjustable with these function codes.

It is possible to set the release and apply conditions based of these signals (current, torque and frequency/speed) so that a hoisted load does not fall down at the start or stop of the operation, or so that the load applied to the brake is reduced.

■ Brake control "BRKS" (E20, E21 and E27, data = 57)

This signal outputs a brake control command that releases or applies the brake.

Releasing the Brake

When the inverter output current and output frequency exceeds the specified level for the brake control signal (J68/J69/J95) for the period specified by J70 (Brake control signal (Brake-release timer)), the inverter judges that required motor torque is generated and turns the signal BRKS ON for releasing the brake.

This prevents a hoisted load from falling down due to an insufficient torque when the brake is released.

Function code	Name	Data setting range	Remarks
J68	Brake-release current	0.00 to 300.00%:	Set the value in percentage (%) of the inverter rated current.
J69	Brake-release frequency/speed	0.0 to 25.0 Hz	
J70	Brake-release timer	0.00 to 5.00s	
J95	Brake-release torque	0.00 to 300.00%	Only available under vector control with speed sensor.

Note: Resolution of each function code is different from the FRENIC-MEGA and FRENIC-Multi series.

Applying the brake

When the run command is OFF and the output frequency drops below the level specified by J71 (Brake control signal (Brake-applied frequency/speed)) and stays below the level for the period specified by J72 (Brake control signal (Brake-applied timer)), the inverter judges that the motor rotation is below a certain level and turns the signal "BRKS" OFF for activating (applying) the brake.

This operation reduces the load applied to the brake, extending lifetime of the brake.

Function code	Name	Data setting range	Remarks
J71	Brake-apply frequency/speed	0.0 to 25.0 Hz	
J72	Brake-apply timer	0.00 to 5.00s	
J96	Brake-apply conditions (Only available when using vector control with speed sensor)	0 to 31 (in decimal) Criteria of speed condition for Brake-apply (Bit 0) 0: Detected speed (default) 1: Reference speed	Specifies the criteria of speed to be used for Brake-apply condition.
		Condition of brake-apply control signal (Bit 4) 0: Regardless of run command status (ON or OFF) (default) 1: Only when run command is OFF."	Specifies whether to turn off a brake control signal independent of a run command ON/OFF or only when a run command is OFF. When forward and reverse operations are switched, Brake-applied conditions may be met in the vicinity of zero speed. For such a case, select "Only when a run command is OFF" (Bit 4 = 1).

Note: Resolution of each function code is different from the FRENIC-MEGA and FRENIC-Multi.

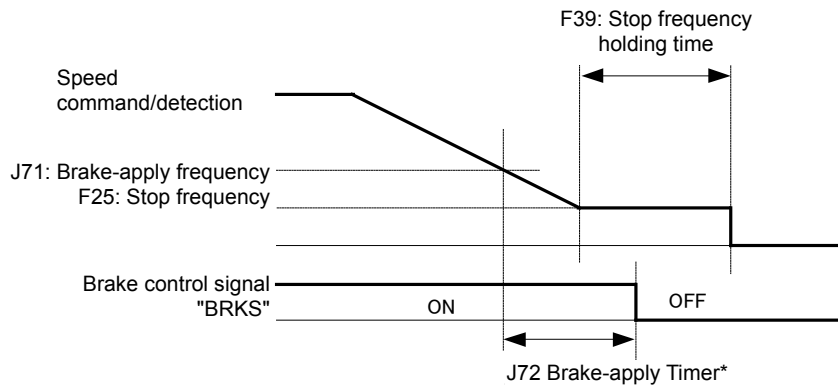

Figure 5.3-15 Time chart

Note

- The brake control signal applies by default to the 1st motor. When the 2nd motor is selected, switch the brake control signal to this motor by setting the corresponding bit of function code A98.
- When the inverter is shut down due to an alarm status or coast-to-stop command, the brake control signal is immediately applied.
- The stop is determined after the output frequency exceeds "F25 stop frequency + E30 frequency arrival hysteresis width", and then the output frequency falls below F25. To inch the motor (repeatedly turn ON and OFF the run command in a short time), adjust F25 and E30.

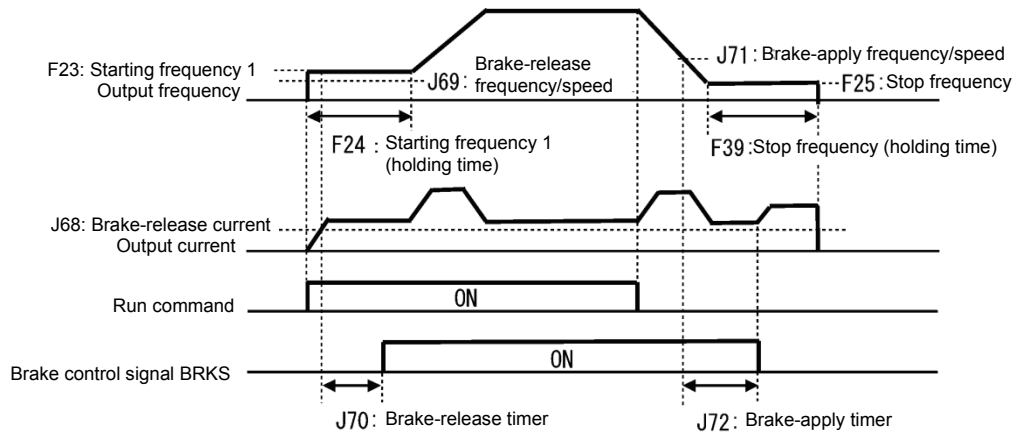

Figure 5.3-16 Operation time chart under v/f control

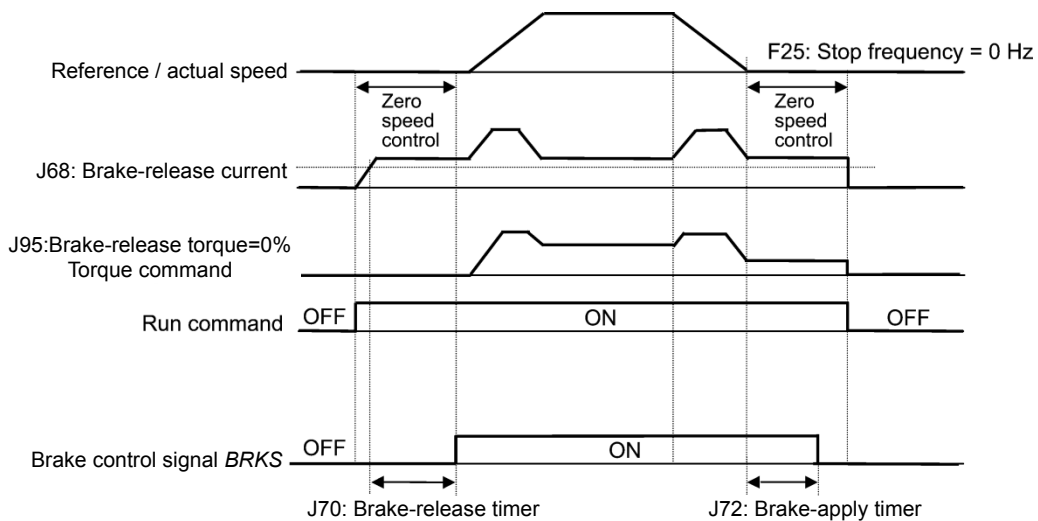

Figure 5.3-17 Operation time chart under vector control with speed sensor



- Set 0% to J95 (Brake-release torque) excluding brake-release at zero speed.
- If releasing the brake at zero speed is needed under vector control with speed sensor, please use the torque bias function.
- After releasing the brake (BRKS ON), operating for a while, and then applying the brake (BRKS OFF) to stop the motor, if it is required to release the brake again (BRKS ON), turn the inverter's run command OFF and then ON.
- The brake is not released during auto-tuning (stop mode).

■ Check brake “BRKE” (E01 to E05 data = 65)

If the status of the brake control signal BRKS fails to agree with the status of the brake check signal BRKE during inverter operation, the inverter occurs alarm to stop with $E-5$.

This signal is used as a feedback signal for the brake control signal BRKS. When the mechanical brake does not operate, it causes the inverter to trip, applying the mechanical brake. The response delay time for BRKS and BRKE can be adjusted with H180: Check-timer for brake operation.

(📖) Function code H180: Brake control signal (Check-timer for brake operation) range 0.00s to 10.00s

[7] Positioning control with pulse counter

J73 to J88

Positioning control parameters

This function allows simple positioning control with pulse counter and requires the PG interface card.





The inverter internally counts the feedback pulses and controls the motor so that the control object moves from the previously specified start point, decelerates and switches to the creep speed operation to arrive at the specified stop position.

■ Function Code List

Table 5.3-22 lists the function codes to be used for positioning control.

Table 5.3-22 Function Codes to be used for positioning control

Code	Name	Data setting range	Unit	Default setting	Change when running
E01 to E05, E98, E99	Terminal [Xn] Function	42 (1042): Activate the limit switch at start point, "LS" 43 (1043): Start/reset, "S/R" 44 (1044): Switch to the serial pulse receiving mode, "SPRM" 45 (1045): Enter the return mode, "RTN"	—	—	N
E20, E21, E27	Terminal [Y1] Function Terminal [Y2] Function Terminal [30A/B/C] Function	80 (1080): Stop position override alarm, "OT" 81 (1081): Under positioning, "TO" 82 (1082): Positioning completed, "PSET" 83 (1083): Current position count overflowed, "POF"	—	—	N
J73	Positioning Control (Start timer)	0.0: Disable 0.1 to 1000.0: Preset time	s	0.0	Y
J74	(Start point, upper digits)	-999 to 999	—	0	Y
J75	(Start point, lower digits)	[P], 0 to 9999 *1	p	0	Y
J76	(Preset point, upper digits)	-999 to 999	—	0	Y
J77	(Preset point, lower digits)	[P], 0 to 9999 *1	p	0	Y
J78	(Creep speed switch point, upper digits)	0 to 999	p	0	Y
J79	(Creep speed switch point, lower digits)	0 to 9999	p	0	Y
J80	(Creep speed)	0 to 500	Hz	0	Y
J81	(End point, upper digits)	-999 to 999	p	0	Y
J82	(End point, lower digits)	0 to 9999	p	0	Y
J83	(Completion range)	0 to 9999	p	0	Y
J84	(End timer)	0.0: Disable. 0.1 to 1000.0: Preset time	s	0.0	Y
J85	(Coasting compensation)	0 to 9999	p	0	Y
J86	(End point, serial pulse input format)	0: Direction and pulse 1: Forward and reverse pulse	—	0	Y
J87	(Preset positioning requirement)	0: Allow to preset at the forward rotation only 1: Allow to preset at the reverse rotation only 2: Allow to preset at any rotation direction	—	0	N
J88	*2 (Direction of detected position)	0: Does not switch the direction of detected position 1: Switch the direction of detected position (Multiply by "-1" the detected position)	—	0	N

*1 [P]: Current position (Absolute position) Switching between "0" and [P] requires the simultaneous keying:  +  keys from "0" to [P] and  +  keys from [P] to "0."

*2 In case of wrong wiring of the PG, inverts the position detection; direction, using J88 it is possible correct the direction without rewiring.

■ **Description of the Control**

The PG interface card allows the inverter to internally count feedback pulses issued from the encoder (PG) and control the motor so that the control object starts moving from the previously specified start point (S point), decelerates and switches to the creep speed operation to arrive at the specified stop position (E point).

Turning the run command ON with “Start/reset” command **S/R** being ON starts the positioning control.

See Figure 5.3-18 “Positioning Control Behaviour” and Table 5.3-23.

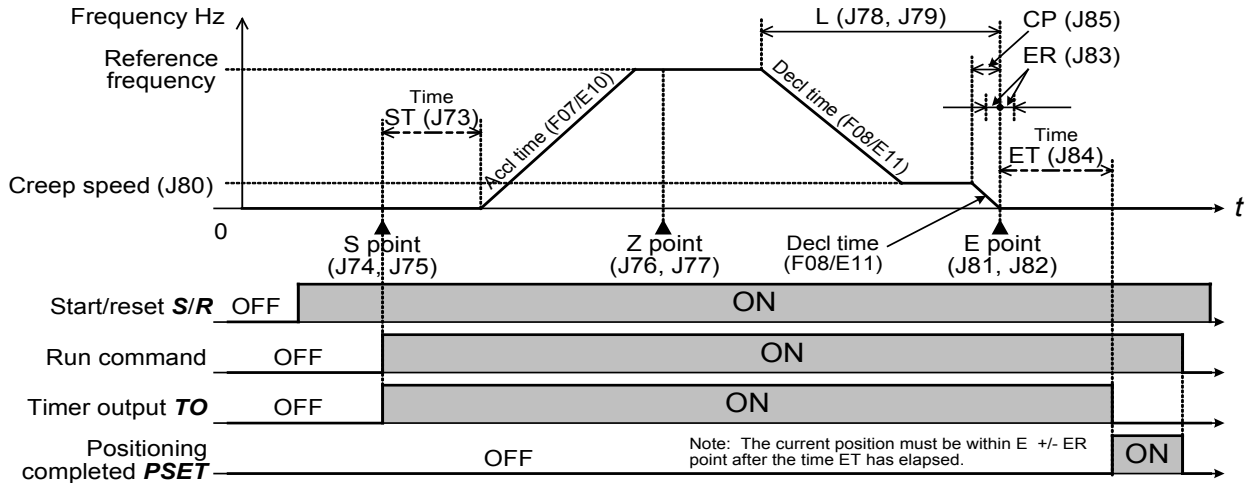

Figure 5.3-18 Positioning Control Behaviour

- Note**
- The positioning control applies to motor 1 only.
 - During jogging (inching) operation or when the PID control is enabled ($J01 \neq 0$), the positioning control is disabled.
 - An undervoltage alarm that occurs in positioning control triggers the alarm E_{r-d} ; however, the inverter does not enter the restart mode (specified by F14).
 - Enabling the positioning control disables the auto-reset function specified by H04 and H05.

Tip The operation status in positioning control can be displayed on the keypad by using Menu #3 “Drive Monitoring.” For details, refer to “Monitoring.” Refer to Chapter 3, see the description of function code E52.

■ Symbols

Table 5.3-23 lists the meanings of symbols used in Figure 5.3-18.

Table 5.3-23 Symbols Meaning

Symbol	Name	Function code	Descriptions
S point	Start point	J74, J75	This specifies the start position data for the positioning control. It can be the current position [P] (absolute position) or numerical value (relative position). Specification of an absolute position and that of a relative position produce different results as described below.
			<p>[Absolute position]</p> <p>Specifying [P] regards the current position as a start point. When starting the positioning control, the inverter applies the current position pulse count as start point data.</p> <p>(Example) Suppose that the current position pulse count = 10,000, the start point data = [P], and the stop point (E point) pulse count = 20,000.</p> <p>Then, when starting the positioning control, the inverter moves the control object from the current position (10,000, as start point data) to the E point (20,000). Accordingly, the object moving pulse count is 10,000 (20,000 - 10,000).</p>
			<p>[Relative position]</p> <p>Specifying "a" (numerical value) substitutes "a" for the current position data. When starting the positioning control, the inverter applies "a" pulses as start point data.</p> <p>(Example) Suppose that the current position pulse count = 10,000, start point data "a" = 4,000, and the stop position (E point) pulse count = 20,000.</p> <p>Then, when starting the positioning control, the inverter moves the control object from the start point pulse count "a" (4,000) instead of the current position data (10,000) to the E point (20,000). Accordingly, the object moving pulse count is 16,000 (20,000 - 4,000).</p>
ST	Start timer	J73	<p>This specifies the waiting time from when a run command comes ON with the "S/R" terminal command being ON until the inverter starts running the motor. (This covers the delay of brake release.)</p> <p>If the output frequency has not been zero (inverter running), turning the terminal command "S/R" ON does not start the timer count. (During deceleration triggered by turning the run command OFF, the start timer does not start neither.)</p>
Z point	Preset position	J76, J77	<p>When the inverter detects that the Z signal is turned from Low to High first after the "LS" terminal command is turned from OFF to ON, it corrects the current position data for the preset position data (Z point). This is functionally equivalent to a mechanical position correction or origin point reset.</p> <p>Specifying [P] to the preset position does not perform the Z point correction.</p> <p>It is also possible to restrict the application of the Z point correction with the "LS" to the motor rotational direction specified by function code J87.</p>
L	Creep speed switch point	J78, J79	These parameters specify the deceleration start point towards the creep speed (specified by J80) as an absolute position.
CP	Coasting correction	J85	<p>These parameters specify the deceleration start point that follows the end of creep speed operation as a pulse count (relative position) from the E point.</p> <p>Take into account the inertia produced when the control object decelerates to stop.</p>
E point	End point	J81, J82	This specifies a target stop position.
ER	Completion range	J83	<p>This specifies the positioning completion range at the E point, that is, "Actual stop position - E point position."</p> <p>After the end timer counts up:</p> <p>If "$\text{Actual stop point} - \text{E point} \leq \text{ER}$", the inverter issues the "Positioning completed" signal "PSET".</p> <p>If "$\text{Actual stop point} - \text{E point} > \text{ER}$", the inverter issues the "Stop point alarm" signal "OT".</p>
ET	End timer	J84	<p>This specifies the waiting time from when the control object stops at E point until the inverter can receive the next positioning control signal.</p> <p>After completion of positioning, when this waiting time has elapsed or when 0.5 second has elapsed if $\text{ET} < 0.5$ second, the inverter issues the "Positioning completed" signal "PSET" or "Stop point alarm" signal "OT".</p> <p>Turning the run command OFF when the ET is counting interrupts the counting, so the inverter does not issue "PSET" or "OT".</p> <p>The inverter ensures that "PSET" and "OT" signals are kept ON for at least 100 ms.</p>

■ Input/output terminal functions

Table 5.3-24 Input Terminal Functions

Terminal function	Terminal command	Description
Activate the limit switch at start point	"LS"	This is used when the inverter corrects the current position data from the preset position data (Z point) specified by function codes J76 and J77. When the inverter detects that the Z signal is turned from Low to High first after the "LS" terminal command is turned from OFF to ON, it triggers the Z point correction. In any other conditions, the "LS" terminal command does not produce any effect.
Start/reset	"S/R"	This enables or disables the positioning control. ON: Enable OFF: Disable
Switch to the serial pulse receiving mode	"SPRM"	This enables or disables the serial pulse receiving mode. When the serial pulse input shares an input terminal with other functional pulse inputs (when the positioning control is concurrently enabled with frequency control with pulse rate input and/or speed control with PG) by function code setting, the inverter counts input pulses from the PG to determine the stop position only when the "SPRM" terminal command is ON. ON: Enable OFF: Disable However, If the serial pulse receiving is exclusively assigned to the digital input terminal for the PG input, the inverter counts the input pulses for the stop position, regardless of the "SPRM" status. Turning the "SPRM" ON resets to zero the pulse count (E point data previously specified by J81 and J82).
Enter the return mode	"RTN"	Starting the positioning control with the "RTN" terminal command being ON enables the return mode in which the inverter moves the control object in the reverse direction while keeping the S and E point data. Using the "RTN" enables the reciprocal positioning control; moving from S to E points and returning from E to S points. ON: Enable OFF: Disable

 **Note** The resets to zero function of the received pulse count (E point specified by J81 and J82), which can be triggered by turning the SPRM from OFF to ON, is always enabled. Take care not to reset to zero the E point mistakenly.

 **Tip** When the positioning control is enabled concurrently with the speed control with PG or frequency control with pulse rate input, the specifications of terminals [XA], [XB], [XZ], [YA], [YB], and [YZ] differ from the ones listed above. For details, refer to Table 5.3-30 of "■ Assignment of PG Terminals When Shared."

Table 5.3-25 Output Terminal Functions

Terminal function	Symbol	Description
Stop position override alarm	“OT”	<p>ON conditions</p> <ul style="list-style-type: none"> The ET time has elapsed (or after 0.5 second if ET < 0.5 s) or “Actual stop position – E-point” > ER data. <p>OFF conditions</p> <p>Except the above ON conditions.</p>
Timer output	“TO”	<p>ON conditions</p> <p>Until the ET time has elapsed after the start timer (J73) starts.</p> <p>OFF conditions</p> <p>Except the above ON conditions. When the ET is cancelled, the output frequency becomes 0 Hz, turning this signal OFF..</p>
Positioning completed	“PSET”	<p>ON conditions</p> <ul style="list-style-type: none"> The ET time has elapsed (or after 0.5 second if ET < 0.5 s) or “Actual stop position – E-point” > ER data. <p>OFF conditions</p> <p>Except the above ON conditions.</p>
Current position count overflowed	“POF”	<p>ON conditions</p> <p>The current position pulse count goes out of the range from -9,999,999 to +9,999,999, regardless of the ON/OFF state of the “S/R” terminal command.</p> <p>OFF conditions</p> <ul style="list-style-type: none"> The position count comes within the specified range after going out of the range, Any run command is turned ON with the “S/R” being ON, or A Z point correction is performed.

■ Monitoring

The positioning control status and the pulse count can be displayed on the keypad by using E43 or Menu #3 “Drive Monitoring” as described in this section.

Table 5.3-26 Monitoring items: Function Code E43 (LED Monitor, Item selection)

Data for E43	Monitor items	Unit	Descriptions	Refer to:
21	Current position pulse	p	Displays the current position pulse count.	Table 5.3-28
22	Position error pulse	p	Displays the pulse count error between the current position and the E point.	

Table 5.3-27 Keypad menu #3 “Drive Monitoring”

LED monitor shows:	Monitor items	Unit	Descriptions	Refer to:
3_17	E point pulse count	p	Displays the E point of positioning control in the pulse count. Turning “RTN” OFF displays E point (J81 and J82); turning it ON displays S point (J74 and J75).	Table 5.3-28
3_18	Current position pulse count	p	Displays the current position pulse count.	
3_19	Position deviation pulse count	p	Displays the pulse count deviation between the current position and E point.	
3_20	Positioning control status	—	Displays the position control status shown in Figure 5.3-19 “Positioning Control Status Transition Model.”	Figure 5.3-19

■ **Displaying system on the LED monitor**

The positioning control handles the pulse count ranging from -9,999,999 to +9,999,999. To display it, the 4-digit LED monitor shows alternately the upper and lower four digits for one second and three seconds, respectively. The lower four digits are followed by a decimal point.

Table 5.3-28 Displaying System for Pulse Count

Pulse count	<ul style="list-style-type: none"> Running status in Running mode and running info in Programming mode on the standard keypad Running status in Running mode on the multi-function keypad 		Remarks
	Upper 4 digits	Lower 4 digits	
+9,999,999	+999	9999.	Maximum display value
+19,999	+1	9999.	The lower digits are not zero-suppressed.
+10,000	+1	0000.	
+9,999	+0	9999.	
+10	+0	0010.	
0	0	0000.	
-10	-0	0010.	
-9,999	-0	9999.	
-10,000	-1	0000.	
-19,999	-1	9999.	Minimum display value
-9,999,999	-999	9999.	

■ **Positioning control status**

In positioning control, the keypad can display the current control status. Figure 5.3-19 shows a control status transition model and Table 5.3-29 lists details of the status.

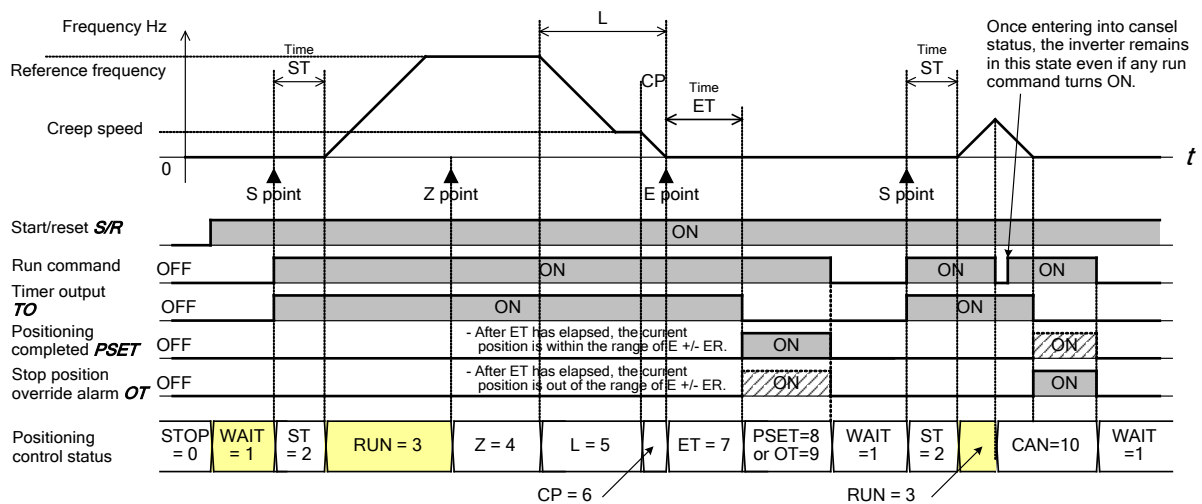

Figure 5.3-19 Positioning Control Status Transition Model

Table 5.3-29 Status Name and Number in Positioning Control

Positioning control status	Status name *1	Status number *2	Descriptions
Positioning control stopped	STOP	0	Status where “S/R” is OFF. Turning “S/R” ON shifts to “WAIT = 1” where the inverter waits for a run command. If the inverter output frequency is other than 0 Hz (Gate output) when “S/R” is turned ON, it shifts to “RUN = 3” since the start timer does not count.
Waiting for run command	WAIT	1	Status where “S/R” is ON and a run command is OFF. Turning a run command ON in this status shifts to “ST = 2.” If the start timer (J73 data) is 0.0 s, the status shifts from “WAIT = 1” to “RUN = 3.”
Start timer counting	ST	2	Status where “S/R” and run command are ON and the start timer is counting. Upon completion of timer count, the status shifts to “RUN = 3.”
Running	RUN	3	Status until the inverter enters into a control zone “Current position \geq (E point - L point)” in forward operation or “Current position \leq (E point + L point)” in returning operation, or until Z point correction occurs.
Z point correction completed	Z	4	If Z point correction occurs in “RUN = 3,” the inverter shifts to this status.
Running in creep speed	L	5	Status where the inverter is decelerating down to the creep speed (J80) or is running at the creep speed.
Coasting	CP	6	Status where the inverter is decelerating to a stop after entering the control zone “Current position \geq (E point - CP point)” in forward operation or “Current position \leq (E point + CP point)” in returning operation.
End timer counting	ET	7	Status where the end timer is counting.
Positioning control completed	PSET	8	Status where the positioning control is completed and the inverter is issuing “PSET”.
Stop position override alarm	OT	9	Status where the inverter is issuing a stop position override alarm “OT”.
Stopped by cancellation	CAN	10	If any inverter operation under positioning control is canceled during any status of “ST = 2” to “ET = 7,” the inverter enters “CAN = 10.” After that, the inverter turns the “Timer output” “TO” OFF and issues the “Positioning completed” “PSET” or “Stop position override alarm” “OT”. Once the inverter enters “CAN = 10”, the inverter remains in this status and keeps the reference frequency at 0 Hz as long as the run command is not turned OFF.

*1: The status name can be displayed in “Drive Monitoring” menu on the LCD monitor of the multi-function keypad.

*2: The status number can be displayed in Menu #3 “Drive Monitoring,” Display item $\overline{3.20}$ on the standard keypad or on the LCD monitor of the multi-function keypad.

■ **Serial Pulse Receiving Function**

When the “S/R” terminal command is assigned to any digital input terminals [X] and the serial pulse receiving function is enabled, the pulse train input from host equipment can specify the stop position (E point). Function codes J81 and J82 (Stop position) save the input pulse count.

Function code J86 specifies the pulse input mode for the serial pulse train input.

Note When the serial pulse receiving input shares an input terminal with other function input (e.g. Table 5.3-30), the inverter counts the PG input pulse train as the serial pulse receiving input for E point pulse count only when “SPRM” is ON. On the contrary, if the serial pulse receiving input terminal is exclusively assigned, the inverter counts the input for E point data independently the ON/OFF status of “SPRM”.

■ **Assignment of PG Terminals When Shared**

Table 5.3-30 lists input assignments for terminals [XA], [XB], [XZ], [YA], [YB] and [YZ] when the positioning control, speed control with PG and speed control with pulse rate input share the PG terminals

The specifications of those terminals when shared differ from the ones when not shared.

Table 5.3-30 Function Assignments of PG Terminals

Pulse train input, F01/C30 data is 12.	Speed control with PG, F42/A14 data is 3 or 4.	Positioning control, S/R is assigned.	Normal mode (Except the right column mode)	Serial pulse receiving mode, SPRM is ON		
No	No	No	X: Pulse monitor			
			Y: Pulse monitor			
		Yes	X: Serial pulse (J86)			
			Y: Positioning control			
	Yes	No	No	X: Pulse monitor		
				Y: Speed control		
Yes		Yes	X: Positioning control	X: Serial pulse (J86)		
			Y: Speed control			
Yes	No	No	X: Pulse train input			
			Y: Pulse monitor			
		Yes	Yes		X: Pulse train input	X: Serial pulse (J86)
					Y: Positioning control	
	Yes	No	No	X: Pulse train input		
				Y: Speed control		
		Yes	Yes	X: Pulse train input	X: Serial pulse (J86)	
				Y: Speed and positioning control		

Symbol “X” in the above table stands for PG terminals [XA], [XB] and [XZ].

Symbol “Y” stands for PG terminals [YA], [YB] and [YZ].

The positioning control is invalid when F42=6 and 15.

Switching to the serial pulse receiving mode with “**SPRM**” involves switching of the input mode, so the idle time insertion is required for a stable switching as listed Table 5.3-31.

Table 5.3-31 Idle Time Required for Stable Mode Switching by “**SPRM**”

Function switching	When “ SPRM ” is turned from OFF to ON:	When “ SPRM ” is turned from ON to OFF:	Remarks
Positioning control to/from serial pulse receiving	Insert a minimum of 100 ms idle time before the start of the serial pulse receiving input after “ SPRM ” is turned ON.	Do not input the serial pulse within 100 ms before or after “ SPRM ” is turned OFF.	—
Pulse train input to/from serial pulse receiving		Stop the serial pulse receiving input before a minimum of 100 ms before “ SPRM ” is turned OFF. Start the pulse train input within 100 ms after “ SPRM ” is turned OFF.	During the “serial pulse receiving mode (“ SPRM ” being ON) + 100 ms,” the inverter holds the pulse train input count applied when “ SPRM ” is turned ON.

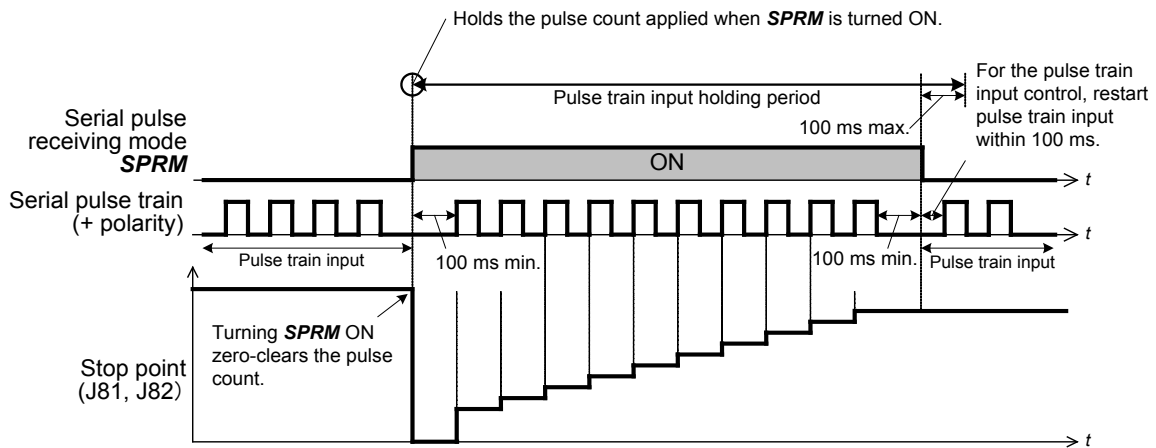

Figure 5.3-20 Switching the Input Mode between the Pulse Train Input and Serial Pulse Receiving Mode

[8] Servo lock

J97 to J99	Servo lock (Gain, Completion timer, Completion range)
------------	---

■ Servo lock

The servo lock function is available only at vector control with speed sensor (F42=6). This function holds the motor within the positioning completion range specified by J99 for the period specified by J98 even if an external force applies to the motor.

Note Do not apply the frequent servo lock because the protection function for power cycle life may operate.

■ Startup conditions of servo lock

Servo lock control starts when the following conditions are met:	
	F38 = 0 (Use actual speed as a decision criteria)
1	Run command OFF, or Reference frequency < Stop frequency (F25)
2	“LOCK” (“Servo lock command”) ON (Assignment of “LOCK” (E01 to E05 data = 47))
3	The actual speed is less than the stop frequency (F25).

	F38 = 1 (Use reference speed as a decision criteria)
3	The reference speed is less than the stop frequency (F25).

■ Operation examples

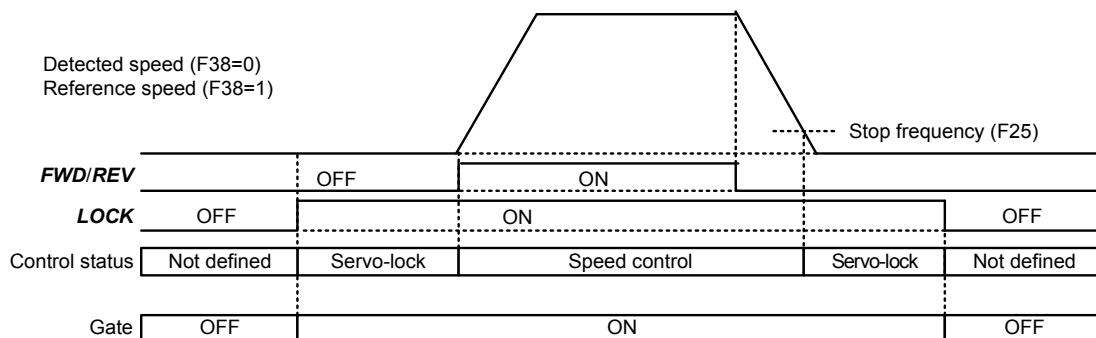

Figure 5.3-21 Typical Control Sequence of servo lock

⚠ WARNING	
When the servo lock command is ON, the inverter keeps on outputting voltage on output terminals [U], [V] and [W] even if a run command is OFF and the motor seems to be in stop state.	
An electric shock may occur.	

■ Specifying servo lock control

Positioning completed signal -- “PSET” (E20, E21 and E27 data = 82), Servo lock (Completion timer) (J98), and Servo lock (Completion range) (J99)

This output signal comes ON when the inverter has been servo locked so that the motor is held within the positioning completion pulse counts specified by J99 and the timer specified with J98 has counted up.

- Data setting range J98: 0.000 to 1.000 (s) (Factory default is 0.100)
- Data setting range J99: 0 to 9999 (pulses) (Factory default is 10)

■ Servo lock (Gain) (J97)

J97 specifies the gain of the servo lock positioning to adjust the stop behavior and shaft holding torque against an external force. If the mechanical stiffness is not high, J97 is difficult to set larger.

J97	Small ↔ Large
Stop behavior	Response slow, but smooth ↔ Response quick, but hunting might occur.
Shaft holding torque	Small ↔ Large

- Data setting range: 0.000 to 9.999 (times) (Factory default is 0.010)

Note: Resolution of J97 and factory default value is different from the FRENIC-MEGA series.

■ Notes for using servo lock

- (1) Positioning control error $E_{r\sigma}$
If a positioning error exceeds the value equivalent to four rotations of the motor shaft when the inverter is servo locked, the inverter issues a positioning control error signal $E_{r\sigma}$.
- (2) Stop frequency (F25) under servo lock
Since servo lock starts when the output frequency is below the stop frequency (F25), it is necessary to specify such F25 data that does not trigger $E_{r\sigma}$ (that is, specify the value equivalent to less than 4 rotations of the motor shaft).
Stop frequency (F25) < (4 × Gain (J97) × Maximum frequency)
(Example) When Gain (J97) = 0.01 and Maximum frequency (F03) = 60 Hz, specify F25 data < 2.4 Hz.
- (3) The following functions are ignored in the servo lock mode:
 - Frequency/speed control specified with the stop frequency
 - Rotation direction limitation

J105 to J107

PID control (Display unit, Maximum scale, Minimum scale)
--

Refer to the description of J02.

J136 to J138

PID control 1 (PID multistep command 1 to 3)
--

For details, refer to the description of J02.

5.3.9 d codes (Applied functions 2)

[1] Speed control

d01/A43/b43/r43	Speed control 1, 2, 3 and 4 (Speed command filter)
d02/A44/b44/r44	(Speed detection filter)
d03/A45/b45/r45	P (Gain)
d04/A46/b46/r46	I (Integral time)
d05/A47/b47/r47	FF(Gain)
d07/A49/b49/r49	(Notch filter resonance frequency)
d08/A50/b50/r50	(Notch filter attenuation level)
	Related function code: d25:ASR switching time

These function codes are used to set up the speed control during normal operation.

■ Block diagram of the speed control algorithm

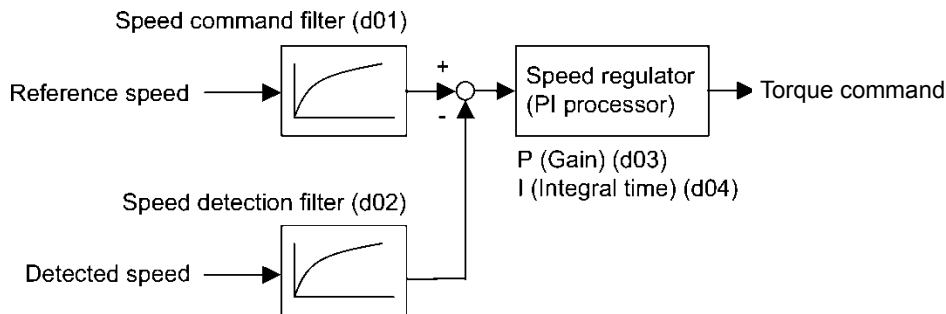

■ Speed command filter (d01/A43/b43/r43)

d01 specifies the time constant determining the first order delay of the speed command filter.

- Data setting range: 0.000 to 5.000 (s)

Modify this data when an excessive overshoot occurs against the change of the reference speed.

Increasing the filter time constant stabilizes the reference speed and reduces overshoot against the change of the reference speed, but it slows the response speed of the inverter.

■ Speed detection filter (d02/A44/b44/r44)

d02 specifies the time constant determining the first order delay of the speed detection filter.

- Data setting range: 0.000 to 0.100 (s)

Modify this data when the control target (machinery) is oscillatory due to deflection of a drive belt or other causes so that ripples (oscillatory components) are superimposed on the detected speed, causing hunting (undesirable oscillation of the system) and blocking the PI processor gain from increasing (resulting in a slow response speed of the inverter). In addition, if a low encoder (PG) resolution makes the system oscillatory, try to modify this data.

Increasing the time constant stabilizes the detected speed and allows to raise the PI processor gain even with ripples superimposed on the detected speed. However, speed detection itself is delayed, resulting in a slower speed response, larger overshoot, or hunting.

■ P(Gain) (d03/A45/b45/r45), I(integral time) (d04/A46/b46/r46)

d03 and d04 specify the gain and integral time of the speed regulator (PI processor), respectively.

- Data setting range: (d03) 0.1 to 200.0 (times)
(d04) 0.001 to 9.999 (s), 999 (Cancel integral term)

P(Gain)

Definition of “P gain = 1.0” is that the torque command is 100% (100% torque output of each inverter capacity) when the speed deviation (reference speed – detected speed) is 100% (equivalent to the maximum speed).

Determine the P gain according to moment of inertia of machinery loaded to the motor output shaft. Larger moment of inertia needs larger P gain to keep the flat response during whole operation.

Specifying a larger P gain improves the quickness of control response, but may cause a motor speed overshooting or hunting (undesirable oscillation of the system). Moreover, mechanical resonance or vibration sound on the machine or motor could occur due to excessively amplified noise. If it happens, decreasing P gain will reduce the amplitude of the resonance/vibration. A too small P gain results in a slow inverter response and a speed fluctuation in low frequency, which may prolong the time required for stabilizing the motor speed.

I(Integral time)

Specifying a shorter integral time shortens the time needed to compensate the speed deviation, resulting in quick response in speed. Specify a short integral time if quick arrival to the target speed is necessary and a slight overshooting in the control is allowed; specify a long time if any overshooting is not allowed and taking longer time is allowed.

If a mechanical resonance occurs and the sound from the motor or gears is abnormal, setting a longer integral time can transfer the resonance point to the low frequency zone and suppress the resonance in the high frequency zone.

■ FF(Gain) (d05/A47/b47/r47)

The inverter operates the feed forward (FF) control that adds the acceleration torque calculated from the variation of speed command to torque command directly.

The PI control of ASR is feed back control and it makes the compensation operation against the result (actual speed detection value). Therefore it can control against the disturbance or the uncertain characteristic of controlled object also. However it becomes a follow-up control even if the variation of speed command is already-known.

The feed forward control can calculate the torque command related to the already-known variation of speed command.

This is the function code that can make the feed forward control.

- Data setting range: 0.00 to 99.99s

When the moment of inertia is known, this function can be used effectively. Conceptually, as it is shown in the following figure, the follow-up speed behaviour against the actual speed command is clearly different between feed forward control valid and invalid. However, to get the maximum effect, it is necessary to adjust this function code setting and the PI control settings value of the ASR.

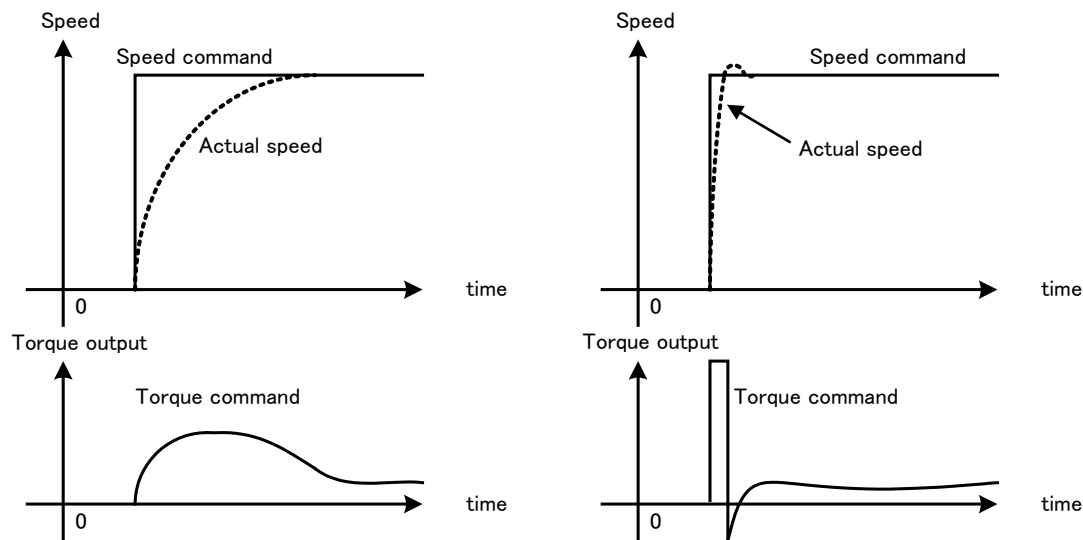

The above mentioned effect can be obtained by setting the P gain of ASR higher. However the response of the system becomes faster in this setting and there is the possibility that it affects negatively due to generation of vibration.

■ Notch filter resonance frequency (d07/A49/b49/r49), Notch filter attenuation level (d08/A50/b50/r50)

These function codes specify speed control using notch filters. The notch filters make it possible to decrease the speed loop gain only in the vicinity of the predetermined resonance points, suppressing the mechanical resonance. The notch filters are available only under “vector control with speed sensor.”

Setting the speed loop gain at a high level in order to obtain quicker speed response may cause mechanical resonance. If it happens, decreasing the speed loop gain the speed response will be slower in the whole operating range. In such a case, using the notch filter makes it possible to decrease the speed loop gain only in the vicinity of the predetermined resonance points and set the speed loop gain at a high level in other operating points, enabling a quicker speed response in the whole operating range.

The following four types of notch filters can be specified.

Function code	Name	Data setting range	Unit	Default setting
d07/A49/b49/r49	Speed control 1, 2, 3, 4 (Notch filter resonance frequency)	1 to 200	Hz	200
d08/A50/b50/r50	Speed control 1, 2, 3, 4 (Notch filter attenuation level)	0 to 20	dB	0 (Disable)

Setting the notch filter attenuation level to “0” (dB) disables the corresponding notch filter.

■ Select speed control parameter 1, 2 -- “MPRM1”, “MPRM2” (E01 to E05 data = 78, 79)

The combination of the ON/OFF states of digital input signals “MPRM1” and “MPRM2” selects one between 4 different speed control parameter sets.

Refer to “5.3.7 b, r codes (Speed control 3 and 4 parameters)”

■ ASR switching time (d25)

Speed control parameters switching by “MPRM1” and “MPRM2” signals is possible even during motor drive operation. For example, speed control P (Gain) and I (Integral time) listed can be switched. Switching these parameters during operation may cause an abrupt change of torque and result in a mechanical shock, depending on the driving condition of the load. To reduce such a mechanical shock, the inverter decreases the abrupt torque change using the ramp function of ASR switching time (d25).

- Data setting range: 0.000 to 1.000 (s)

d09, d10 d11, d12 H147	Speed control (Jogging) (Speed command filter and Speed detection filter) (P (Gain) and I (Integral time), FF(Gain)) (Refer to d01.)
------------------------------	--

These function codes are used to set up the speed control during jogging operation.

The block diagrams and function codes related to jogging operation are the same as for normal operation.

Since this speed control setting is exclusive to jogging operations, specify these function codes to obtain higher speed response to obtain smooth jogging operation.

For details, refer to the corresponding descriptions (d01 to d05) about the speed control sequence for normal operation.

Speed control parameters	Jogging operation	Normal operation
Speed command filter	d09	d01
Speed detection filter	d10	d02
P (Gain)	d11	d03
I (Integral time)	d12	d04
FF(Gain)	H147	d05

d14 to d17	Feedback Input (Pulse input format, Encoder pulse resolution, Pulse scaling factor 1 and Pulse scaling factor 2)
-------------------	---

These function codes specify the speed feedback input under vector control with speed sensor.

■ **Feedback Input, Pulse input format (d14)**

d14 specifies the speed feedback input format.

Data for d14	Pulse input mode	Remarks
0	Frequency and direction	
1	Forward and reverse pulse	
2	Quadrature A/B signal (B phase lead)	
3	Quadrature A/B signal (A phase lead)	<p>This setting is the inversion of d14 = 2. (Lead phase A Forward rotation)</p> <p>In case that YA and YB are reversely connected to the specified terminals, setting "3" to this function code can reverse the polarity of detected speed (position) without changing the connection.</p>

■ **Feedback Input, Encoder pulse resolution (d15)**

d15 specifies the pulse resolution (P/R) of the speed feedback encoder.

- Data setting range: 20 to 60000 (P/R), Set by standard keypad using hexadecimal format (0x0014 to 0xEA60)

■ **Feedback Input, Pulse scaling factor 1 (d16) and Pulse scaling factor 2 (d17)**

d16 and d17 specify the factors to convert the speed feedback input pulse rate into the motor shaft speed (min^{-1}).

- Data setting range: 1 to 9999

Specify the data according to the transmission ratios of the pulley and gear train as shown below.

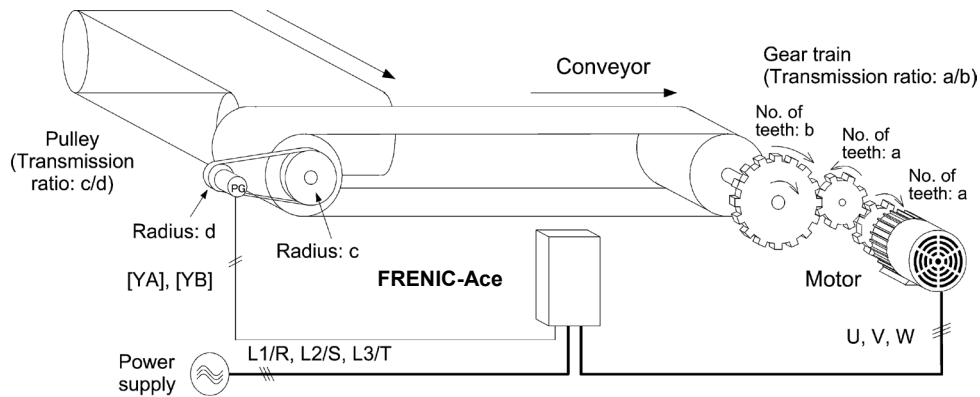

Figure 5.3-22 An Example of a Closed Loop Speed Control System (Conveyor)

Listed below are expressions for conversion between the speed feedback input pulse rate and the motor shaft speed.

$$\text{Motor shaft speed} = \frac{\text{Pulse scaling factor 2 (d17)}}{\text{Pulse scaling factor 1 (d16)}} \times \text{Encoder shaft speed}$$

$$\frac{\text{Pulse scaling factor 2 (d17)}}{\text{Pulse scaling factor 1 (d16)}} = \frac{b}{a} \times \frac{d}{c}$$

$$\text{Pulse scaling factor 1 (d16)} = a \times c$$

$$\text{Pulse scaling factor 2 (d17)} = b \times d$$



When driving the motor under the vector control with speed sensor, mount the sensor encoder to the motor shaft directly, or to a shaft with the rigidity equivalent to the motor shaft. A backlash, slip or deflection being on the mounting shaft could interfere with normal control.

Please be sure that the encoder wiring is done correctly. Otherwise an accident could occur.

d21, d22
d23**Speed agreement/PG error (Hysteresis width and detection timer)
PG error processing**

These function codes specify the detection levels of the speed agreement signal “**DSAG**” and PG error detected signal “**PG-ERR**”.

Speed agreement signal “DSAG” (E20, E21 and E27, data = 71)■ **Speed agreement/PG error (Hysteresis width (d21) and detection timer (d22))**

- Data setting range: (d21) 0.0 to 50.0 (%), in (%) of the maximum speed
(d22) 0.00 to 10.00 (s)

If the speed regulator’s deviation (between the reference speed and detected one) is within the specified range (d21), the signal “**DSAG**” turns ON. If the deviation is out of the specified range (d21) for the specified period (d22), the signal turns OFF. This signal allows the user to check whether the speed regulator works properly or not.

PG error detected signal PG-ERR (E20 to E21 and E27, data = 76)■ **Speed agreement/PG error (Hysteresis width (d21), Detection timer (d22) and PG error processing (d23))**

- Data setting range: (d21) 0.0 to 50.0 (%), in (%) of the maximum speed
(d22) 0.00 to 10.00 (s)
(d23) 0 to 5

If the speed regulator’s deviation (between the reference speed and detected one) is out of the specified range (d21) for the period specified by d22, the inverter judges it as a PG error.

d23 defines the detection condition (and exception), processing after error detection, and hysteresis width as listed below.

d23	Function	Detection condition (and exception)	Processing after error detection	Hysteresis width for error detection
0	Continue to run 1	When the inverter cannot follow the reference speed (even after soft-starting) due to a heavy overload or similar, so that the detected speed is less than the reference speed, the inverter does not interpret this situation as a PG error.	The inverter outputs the PG error detected signal “ PG-ERR ” and continues to run.	Hysteresis width = d21, which is constant, even if the speed command is above the base frequency (F04).
1	Stop running with alarm 1		The inverter initiates a motor coast to stop, with the $E_r\bar{E}$ alarm. It also outputs the PG error detected signal “ PG-ERR ”.	
2	Stop running with alarm 2		No exception.	
3	Continue to run 2	When the inverter cannot follow the reference speed (even after soft-starting) due to a heavy overload or similar, so that the detected speed is less than the reference speed, the inverter does not interpret this situation as a PG error.	The inverter outputs the PG error detected signal “ PG-ERR ” and continues to run.	If the speed command is below the base frequency (F04), hysteresis width = d21, which is constant. If it is above the base frequency, hysteresis width = $d21 \times \text{Speed command} / \text{Maximum frequency} / \text{Base frequency}$ (F04).
4	Stop running with alarm 3		The inverter initiates a motor coast to stop, with the $E_r\bar{E}$ alarm. It also outputs the PG error detected signal “ PG-ERR ”.	
5	Stop running with alarm 4		No exception.	



Enabling an operation limiting function such as the torque limit and droop control will increase the deviation caused by a huge gap between the reference speed and detected one. In this case, the inverter may trip interpreting this situation as a PG error, depending on the running state. To avoid this incident, set the d23 data to “0” (Continue to run) to prevent the inverter from tripping even if any of those limiting functions is activated.

d24	Zero speed control	(Refer to F23)
-----	---------------------------	----------------

Refer to the description of F23.

d25	ASR switching time	(Refer to d01)
-----	---------------------------	----------------

Refer to the description of d01.

d32, d33	Speed limits / Over speed level 1 and 2	(Refer to H18)
----------	--	----------------

Under speed control, the over speed detection levels are specified with 120% of these function codes.

The other hand, these function codes specifies the speed limit value under torque control.

Refer to the description of H18.

d35	Over speed detection level	(Refer to H18)
-----	-----------------------------------	----------------

Refer to the description of H18.

d41	Application specific function selection
-----	--

d41 selects/deselects line speed control or master-follower operation (immediate synchronization mode at the start or follow-up mode during acceleration).

Line speed control suppresses an increase in line speed resulting from the increasing radius of the take-up roll in a winder system.

Master-follower operation drives two or more shafts of a conveyer while keeping their positions in synchronization.

■ Application specific function selection (d41)

Data for d41	Function
0	Invalid
1	Line speed control with speed sensor Note: This control is valid only when "V/f control with speed sensor" or "Vector control with speed sensor (with auto torque boost)" is selected with F42, A14, b14, or r14 (data = 3 or 4).
2	Master-follower operation(Immediate synchronization mode at the start, without Z phase)
3	Master-follower operation(Follow-up mode during acceleration)
4	Master-follower operation(Immediate synchronization mode at the start, with Z phase)

Line speed control

In a winder system (e.g., roving frames, wiredrawing machines), if the inverter continues to run the motor at a constant speed, the take-up roll gets bigger with materials (roving, wire, etc.) and its radius increases so that the winding speed of the take-up roll increases.

To keep the line speed (winding speed) constant, the inverter detects the winding speed using a speed sensor (encoder) and controls the motor rotation according to the encoder feedback.

Machinery configuration of winder system and function code settings

Shown below is a machinery configuration of a winder system for which it is necessary to configure the function codes as listed below.

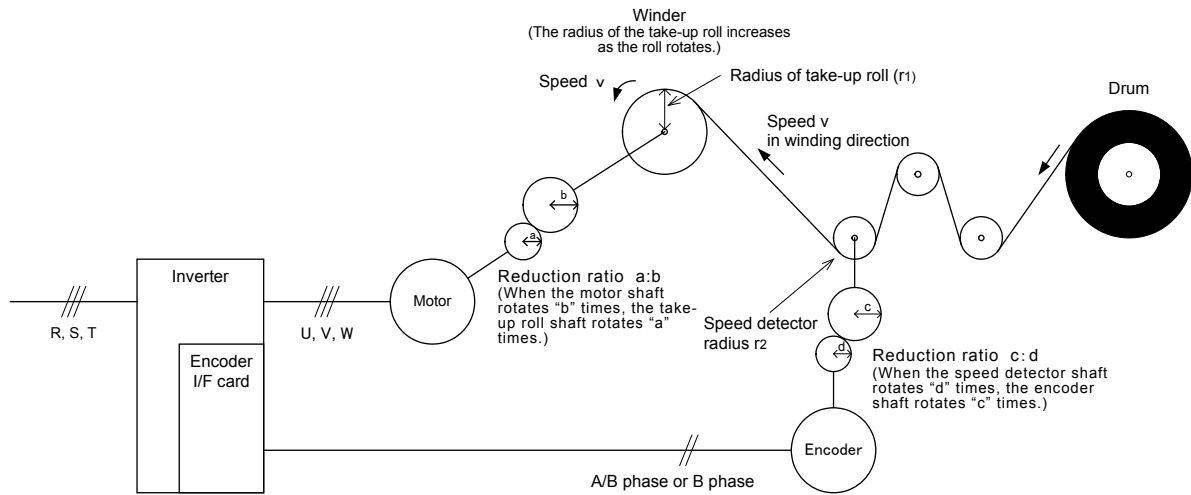

- Speed reduction ratio between motor shaft and take-up roll shaft a : b
- Speed reduction ratio between speed detector shaft and encoder shaft c : d
- Radius of take-up roll before winding r₁
- Radius of speed detector r₂

Table 5.3-32 Setting the Reduction Ratio

Function code	Name	Settings
d15	Encoder pulse resolution	Encoder pulse resolution (P/R)
d16	Pulse scaling factor 1	Speed reduction ratio of the whole machinery (load)
d17	Pulse scaling factor 2	$\frac{K_2}{K_1} = \frac{r_2}{r_1} \times \frac{b}{a} \times \frac{d}{c} = d17/d16$ d16: Denominator factor for the speed reduction ratio (K1 = r ₁ × a × c) d17: Numerator factor for the speed reduction ratio (K2 = r ₂ × b × d)

■ Line speed command

Under line speed control, speed commands should be given as line speed commands.

Setting with digital inputs

To digitally specify a line speed in m/min, make the following settings.

Function code	Name	Settings
E48	LED monitor (Speed monitor item)	5: Line speed
E50	Display coefficient for speed monitor	$K_s = \frac{240\pi \times a \times r_1}{p \times b}$ Ks: Display coefficient for transport time (E50) p: Number of motor poles a, b: Components of speed reduction ratio between motor shaft and take-up roll shaft (When the motor shaft rotates “b” times, the take-up roll shaft rotates “a” times.) r1: Radius of take-up roll before winding (initial value) in m

Setting with analog inputs

To specify a line speed using analog inputs, set an analog input (0 to 100%) based on the following equation.

$$\text{Analog input (\%)} = \frac{p \times b \times 100}{240\pi \times r_1 \times a \times f_{\max}} \times V$$

Where

V: Line speed in m/min

f_{\max} : Maximum frequency 1 (F03)

■ Adjustment

Like usual speed controls, it is necessary to adjust the speed command filter, speed detection filter, P gain, and integral time in the speed control sequence that controls the line speed at a constant level.

Function code	Name	Key points
d01	Speed control (Speed command filter)	If an excessive overshoot occurs for a speed command change, increase the filter constant.
d02	Speed control (Speed detection filter)	If ripples are superimposed on the speed detection signal so that the speed control gain cannot be increased, increase the filter constant to obtain a larger gain.
d03	Speed control P (Gain)	If hunting is caused in the motor speed control, decrease the gain. If the motor response is slow, increase the gain.
d04	Speed control I (Integral time)	If the motor response is slow, decrease the integral time.

■ Cancel line speed control -- “Hz/LSC” (Function code E01 to E05, data = 70)

Turning ON “Hz/LSC” cancels line speed control. This disables the frequency compensation of PI processor, resulting in no compensation for a take-up roll getting bigger and an increase in the winding speed.

Use this signal to temporarily interrupt the control for repairing a thread break, for example.

“Hz/LSC”	Function
OFF	Enable line speed control (depending on d41 setting)
ON	Cancel line speed control (V/f control, without compensation for a take-up roll getting bigger)

■ **Hold line speed control frequency in the memory -- “LSC-HLD” (Function code E01 to E05, data = 71)**

If “LSC-HLD” is turned ON under line speed control, stopping the inverter (including an occurrence of an alarm and a coast-to-stop command) or turning “Hz/LSC” ON saves the current frequency command compensating for a take-up roll getting bigger, in the memory. At the time of restart, the saved frequency command applies and the inverter keeps the line speed constant.

“LSC-HLD”	Function
OFF	Disable (No saving operation)
ON	Enable (Saving the frequency command compensating for a take-up roll getting bigger)



Shutting down the inverter power during operation stop loses the frequency compensation data saved in the memory. At the time of restart, therefore, the inverter runs at the frequency without compensation so that a large overshoot may occur.

d51, d52 d55, d69, d79, d88 d91 to d97	Reserved for particular manufacturers
---	---------------------------------------

These function codes are reserved for particular manufacturers. Unless otherwise specified, do not access these function codes.

d60	Command (Pulse train input) (Encoder pulse resolution)
-----	--

d60 specifies the pulse resolution (P/R) of the command pulse.

- Data setting range: 20 to 3600 (P/R), Set by standard keypad in hexadecimal format (0x0014 to 0x0E10)

d61 to d63	Command (Pulse train input) (Filter time constant, Pulse scaling factor 1 and Pulse scaling factor 2) (Refer to F01.)
------------	--

Refer to the description of the function code F01 for details on the pulse rate input.

d67	PMSM starting mode (Auto search)
-----	----------------------------------

Refer to the description of the function code H09 for details on the PMSM starting mode.

[2] Master-follower operation

d71 to d78	Master-follower operation
------------	---------------------------

These function codes specify various parameters required for master-follower operation.

■ **Application-Defined Control (d41)**

Data for d41	Function
2	Immediate synchronization mode at the start, without Z phase
3	Start after synchronization mode
4	Immediate synchronization mode at the start, with Z phase

The master-follower operation control enables the follower inverter to detect the master motor rotation with PG signals and synchronize the follower motor with the master motor in rotation speed and position.

The master-follower operation is available in three modes: Immediate synchronization mode at the start, with Z phase (d41 = 4) and without Z phase (d41 = 2) and Start after synchronization mode (d41 = 3).

PG signals from master motor should be fed to terminals XA, XB, and XZ, and follower motor's ones, to terminals YA, YB, and YZ.

Table 5.3-33 Specifications of Master-follower operation

	Item	Specifications	Remarks
Control	Speed control range under V/f control with speed sensor	1:100	4-pole motors and PGs with 1024 P/R Speed reduction ratio = 1:1 During running at constant speed
	Speed control range under vector control with speed sensor	1:1500	
	Position control accuracy	$\pm 2^\circ$	
Electrical requirements	Input pulse rate	10 p/s to 100 kp/s *	Maximum wiring length: 100 m (328 ft) * When using quadrature encoders

* For PGs with an open collector output, the input pulse rate is 30 kp/s or below and the maximum wiring length is 20 m (66 ft).

■ Immediate synchronization mode at the start

In immediate synchronization mode at the start (d41 = 2 or 4), the inverter controls the rotation speed and position of the follower motor to maintain the difference between the master and follower motors (hereafter called deviation) at the time when the single motor drive operation is switched to the master-follower operation. That is, it keeps the deviation between the integrated position pulses of the master and follower motors at zero.

If the deviation falls below the synchronization completion detection angle (specified by d77), the inverter issues an “SY” synchronization completion signal. If synchronization is lost so that the position error exceeds 10 times of the excessive error setting (specified by d78), the inverter shuts down its output with the E_{r0} alarm.

When d41 = 4 (Immediate synchronization mode at the start, with Z phase), if any incorrect count due to electrical noise or other factors is found in the integrated count of A/B phases, the inverter corrects the error based on the Z phase difference.

When a run command for the follower motor is turned ON, the inverter continues to monitor the motor positions even if the master motor stops as long as the master-follower operation is not switched to the single motor drive operation. When the master motor starts running again, the inverter restarts to control the follower motor to maintain the Z phase difference between the master and follower motors.

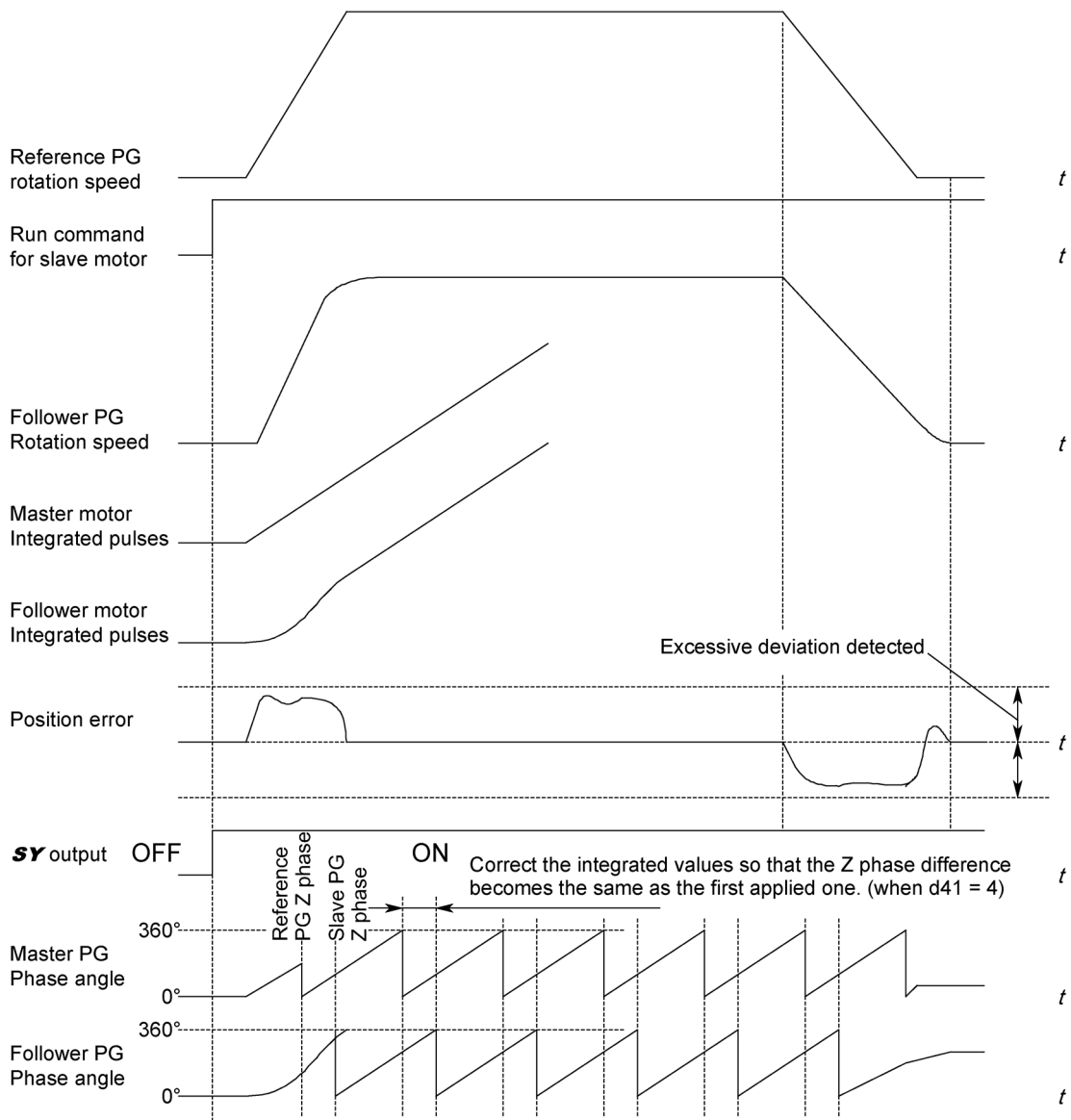

Figure 5.3-23

■ Start after synchronization mode

In Start after synchronization mode (d41 = 3), the inverter controls the follower motor to synchronize its Z phase with the master motor's Z phase, based on the first detected Z phases (positions) of those two motors after the start of master-follower operation. The follower motor could cause a single cycle delay at a maximum (on standby) at the start of operation.

Once the follower motor starts running after standby, it will never go standby unless the master-follower operation is cancelled (see [Note 1](#) below).

The Z phase synchronization angles of the master and follower motors can be adjusted with d76.

The inverter integrates the position pulses for each of the master and follower motors and controls the follower motor's rotation speed and position to keep the deviation between those two motors at zero.

If any incorrect count due to electrical noise or other factors is found in the integrated count of A/B phases, the inverter corrects the error based on the Z phase difference.

If the deviation between those two motors falls below the synchronization completion detection angle (specified by d77), the inverter issues an "SY" synchronization completion signal. If synchronization is lost so that the position error exceeds 10 times of the excessive error setting (specified by d78), the inverter shuts down its output with the E_{r0} alarm.

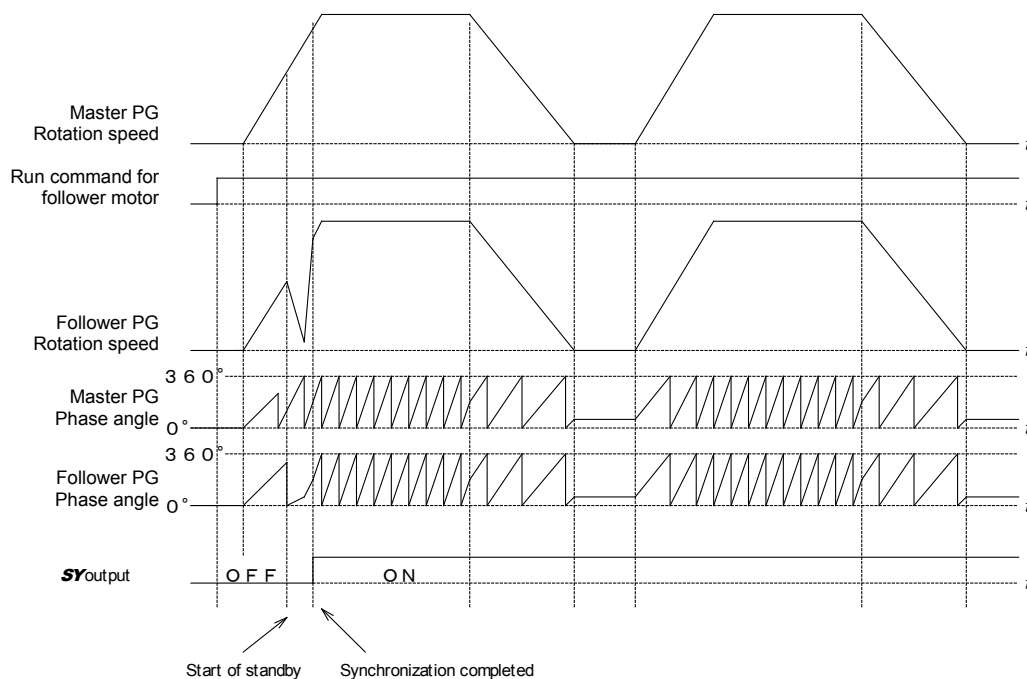

Figure 5.3-24

Note 1: Master-follower operation cancellation conditions

In any of the following cases, the master-follower operation is canceled.

- The run command for the follower motor is turned OFF.
- Terminal command "BX" ("Coast to a stop") or "STOP" ("Force to stop") is turned ON.
- Any alarm occurs.
- The inverter switches to a single motor drive. (Assign terminal command "Hz2/Hz1" and switch the frequency setting source with F01/C30.)
- Under torque control or when the inverter is driven by commercial power.

Block Diagrams

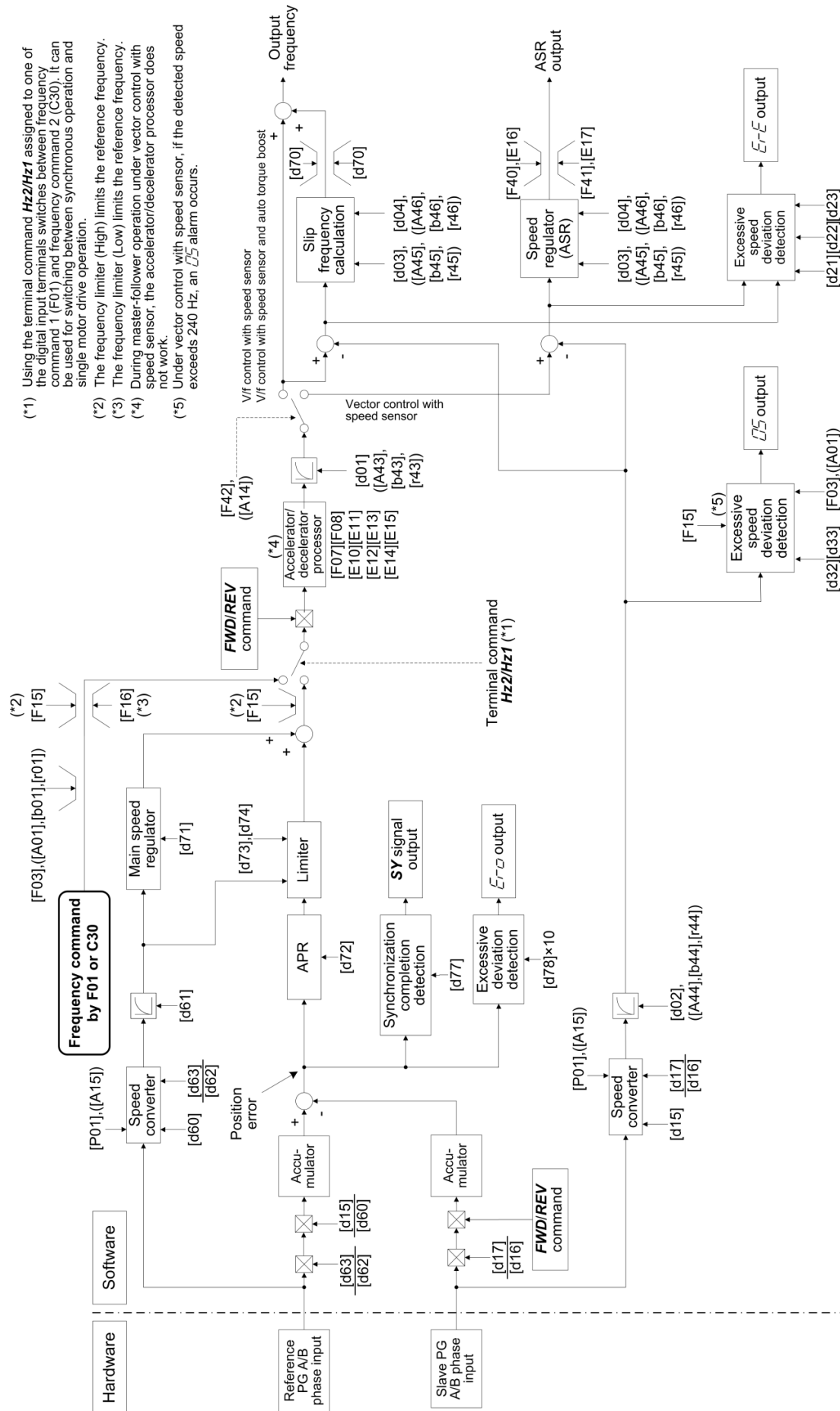

Figure 5.3-25 Block Diagram for Master-follower operation without Z Phase Compensation (d41 = 2)

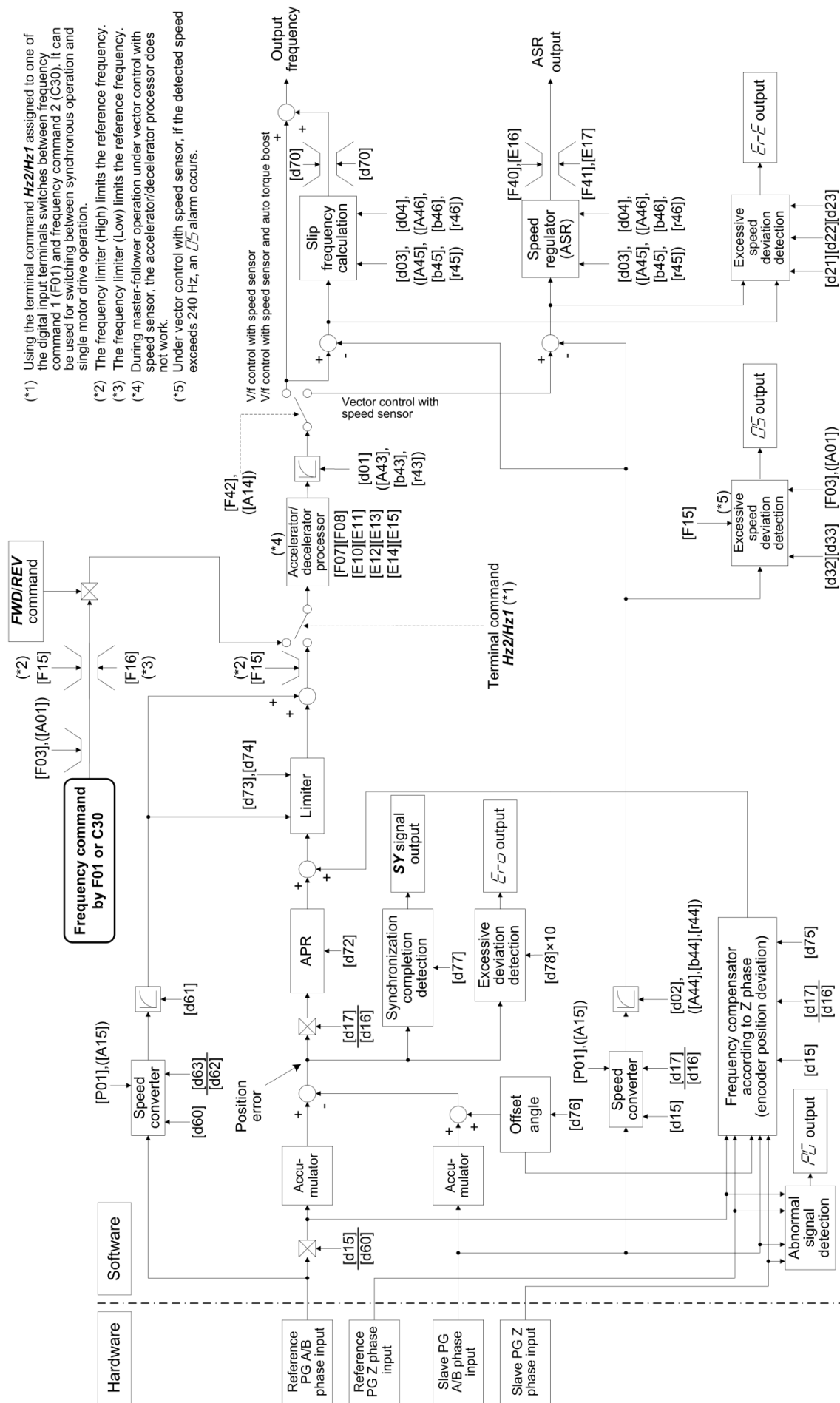

Figure 5.3-26 Block Diagram for Master-follower operation with Z Phase Compensation (d41 = 3 or 4)

■ Unavailable Function Codes

During master-follower operation, the following functions are not available.

F16	Frequency Limiter (Low)
C30	C01 to C04:Jump Frequency

Selecting “Vector control for induction motor with speed sensor” (F42 = 6) disables the settings of the following functions during master-follower operation, as well as making the above functions unavailable.

F07, F08	Acceleration Time 1/Deceleration Time 1
E10, E11	Acceleration Time 2/Deceleration Time 2
E12, E13	Acceleration Time 3/Deceleration Time 3
E14, E15	Acceleration Time 4/Deceleration Time 4
F24	Starting frequency (Holding time)
F39	Stop frequency (Holding time)

During master-follower operation, the following control should be disabled (H18 = 0, J01 = 0).

H18	Torque control
J01	PID control

Configuring Function Codes

To perform master-follower operation, be sure to select a control mode with speed sensor (F42 = 3, 4 or 6) and configure the function codes given in this section.

■ Data setting for master-follower operation

F01	Frequency setting 1
C30	Frequency setting 2

Select the pulse train input (F01/C30 = 12) as a reference command source.

Switching between master-follower operation and individual operation is possible using the “Hz2/Hz1” terminal command (see Figure 5.3-25 and Figure 5.3-26). The switching example is given below.

(Example) Turning terminal [X1] ON for individual operation during which a digital frequency command drives the inverter

Set F01 and C30 data to “12” and “0”, respectively. And set E01 data to “11” to assign the “Hz2/Hz1” command to terminal [X1].

It is recommended to perform switching between master-follower operation and individual operation when the inverter is stopped. Switching when the inverter is running may activate the protective function. To avoid it, decrease the difference between the output frequency and the reference frequency to apply after switching.

F07/E10/E12/E14	Acceleration Time
F08/E11/E13/E15	Deceleration Time

Also in master-follower operation, the inverter controls the output frequency according to the acceleration /deceleration time as usual. Set the acceleration/deceleration time as short as possible. Be careful that, setting the acceleration/deceleration time longer than that of the reference inverter loses the following capability of the follower motor.

 Selecting “Vector control for induction motor with speed sensor” (F42 = 6) ignores the acceleration /deceleration times specified by the function codes, running the motor with the acceleration/deceleration time 0.0 s.

F23, F24	Starting frequency, Starting frequency (Holding time)
F25, F39	Stop frequency, Stop frequency (Holding Time)

Set the starting frequency and stop frequency as low as possible to the extent that the motor can generate enough torque.

During master-follower operation, basically set the holding times for the starting frequency and stop frequency at 0.0 s.

Running at a frequency lower than the stop frequency or starting frequency the master cannot be followed.

Be careful that specifying the holding time deteriorates the following capability at the time of startup or stop.



Selecting "Vector control for induction motor with speed sensor" (F42 = 6) ignores the starting/stop frequencies specified by the function codes, running the motor with the holding time 0.0 s.

F42	Drive Control Selection 1
------------	---------------------------

To perform master-follower operation, select a control mode with speed sensor (F42 = 3, 4 or 6).

Usually, select "V/f control with speed sensor" (F42 = 3).

d01 to d05	Speed Control (Speed command filter, Speed detection filter, P (Gain), I (Integral time), FF(Gain))
-------------------	--

These function codes set up the speed control response. Refer to d01.

d14 to d17	Feedback Input (Pulse input format, Encoder pulse resolution, Pulse scaling factor 1, Pulse scaling factor 2)
-------------------	--

These function codes specify the speed feedback input under vector control with speed sensor (F42 = 3, 4 or 6).

Refer to d14 to d17

d59, d60	Command (Pulse train Input)
d62, d63	(Pulse input format, Encoder pulse resolution, Pulse scaling factor 1, Pulse scaling factor 2)

These function codes specify the command frequency to apply to the inverter. The setting items are the same as for feedback input (d14 to d17).

Refer to F01.

d61	Command (Pulse train Input) (Filter time constant)
------------	---

d61 specifies a filter time constant for pulse train input. Choose an appropriate value for the time constant taking into account the response speed of the machinery system since a large time constant slows down the response. When the reference frequency fluctuates due to small number of pulses, specify a larger time constant.

d71	Master follower operation (Main speed regulator gain)
------------	---

d71 adjusts the main speed regulator gain to control the response and the steady-state deviation. Usually, it is not necessary to change the factory default.

Selecting simultaneous start synchronization without Z phase compensation (d41 = 2) only enables the setting made with d71.

d72 Master follower operation (APR gain)

d72 determines the response of the automatic position regulator (APR). (See Figure 5.3-25 and Figure 5.3-26)
 If the APR output comes to be a single rotation of the encoder shaft per second when the phase angle error (position deviation) between the master and follower PGs becomes equal to a single rotation of the encoder shaft, that gain is assumed to be 1.0.
 Setting a too large value to the gain data easily causes hunting, and setting a too small value results in a large steady-state deviation.
 Adjust the gain, referring to Figure 5.3-27 as a guide. If the d72 setting is adjusted, it is recommended to adjust also the d02 setting as shown in Figure 5.3-27.

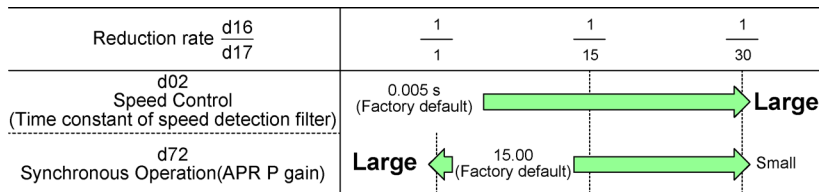

Figure 5.3-27 d72 Setting Guide

d73 Master follower operation (APR positive output limiter)
d74 Master follower operation (APR negative output limiter)

These function codes specify the limits of APR output relative to the master motor speed. (See Figure 5.3-25 and Figure 5.3-26)
 Specification of "999" disables the limiter.

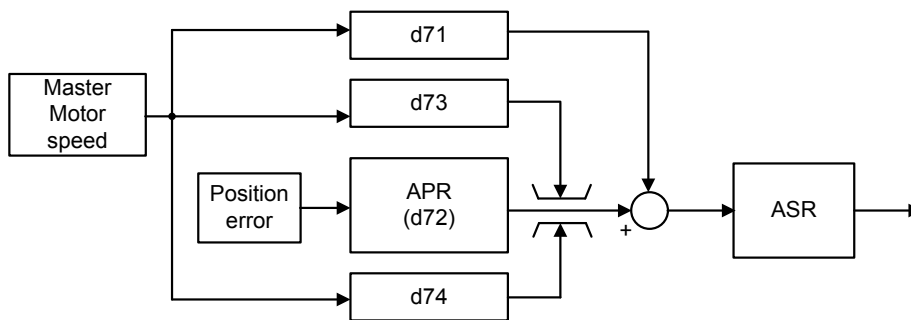

Figure 5.3-28 Operation of APR output limiter

d75 Master follower operation (Z phase alignment gain)

If the APR output reaches the maximum frequency when the phase angle error between the master and follower PGs (position deviation) becomes 10% of the pulse rate at the maximum frequency, that gain is assumed to be 1.0.
 Usually, it is not necessary to change the factory default. If the reduction ratio is small and the encoder pulse count is low, it is necessary to decrease the Z phase alignment gain relative to the factory default.

d76 Master follower operation (Offset angle between master and follower)

In follow-up mode during acceleration, the follower inverter delays starting to synchronize the Z phase with that of the master motor by the offset angle specified by this function code.

d77 Master follower operation (Synchronization completion detection angle)

d77 specifies the synchronization completion detection angle.

If the absolute value of the phase angle error (position deviation) between the master and follower PGs becomes equal to or below the synchronization completion detection angle specified by d77, the inverter issues a synchronization completed signal "SY", provided that the E20, E21 or E27 data (Terminal function) is set to "29" (Synchronization completed).

Once turned ON, the synchronization completed signal "SY" is kept ON for 100 ms.

360 degree of the detected angle is equivalent to 4 times d15.

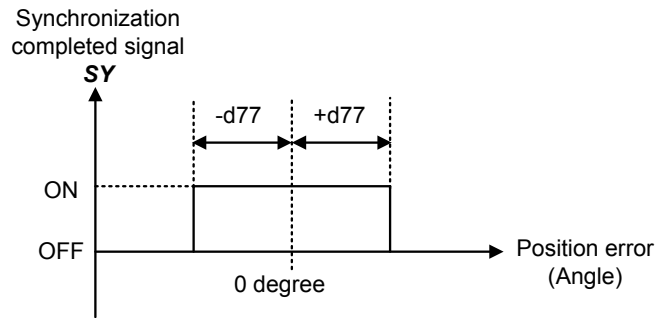

Figure 5.3-29 Synchronization Completion Detection Signal "SY"

d78 Master follower control (Excessive error detection level)

d78 specifies the detection level for excessive error alarm (E_{rD}).

If the absolute value of the phase angle deviation (position deviation) between the master and follower PGs exceeds 10 times the d78 setting, the inverter issues an alarm E_{rD} and shuts down its output.

During master-follower operation, the inverter always monitors an excessive deviation. The d78 setting should be made taking into account that the deviation temporarily increases immediately after the start of running.

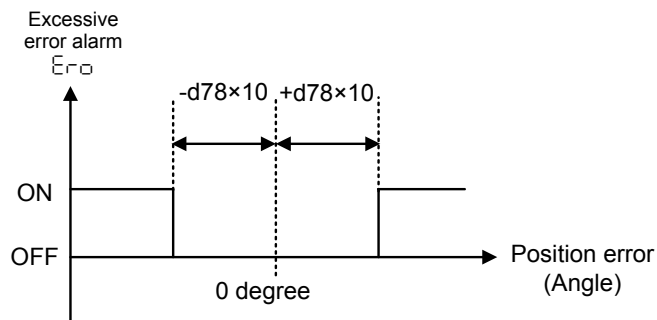

Figure 5.3-30 Excessive error alarm E_{rD}

d70**Speed control limiter**

d70 specifies a limiter for the PI value output calculated in speed control sequence under “V/f control with speed sensor” or “dynamic torque vector control with speed sensor.”

A PI value output is within the “slip frequency × maximum torque (%)” in a normally controlled state.

If an abnormal state such as a temporary overload arises, the PI value output greatly fluctuates and it may take a long time for the PI value output to return to the normal level. Limiting the PI value output with d70 suppresses such abnormal operation.

- Data setting range: 0 to 100 (%) (assuming the maximum frequency as 100%)

d90**Magnetic flux level during deceleration under vector control for IM**

d90 specifies the magnetic flux level to be applied during deceleration under vector control for Induction motor by percentage of the rated motor magnetic flux (determined by P06/A20).

d90 data takes effect only when H71 = 1 (Deceleration Characteristics enabled) and F42/A14 = 6 (Vector control for induction motor with speed sensor).

Increasing the d90 setting can reduce the deceleration time but increases the inverter output current and the motor temperature rise. In applications repeating frequent start/stop drive, an overload may apply to the inverter or motor.

Adjust the d90 setting so that the inverter output current (RMS equivalent) comes to be smaller than the motor rated current.



Use the default setting “150%” as long as there is no problem.

d99**Extended function 1**

To enable the jogging operation “**JOG**” from communication, set bit 3=1 for this function.



Other bits than bit 3 of this function code are for manufacturers. Do not change these bits.

To change the d99 data, it is necessary to press the  +  keys (simultaneous keying).

5.3.10 U codes (Customizable logic operation)

The customizable logic function allows the user to form a logic or operation circuit for digital/analog input/output signals, customize those signals arbitrarily, and configure a simple relay sequence inside the inverter.

In the customizable logic, one step (component), depending on the type, is composed of:

- (1) Digital 2 inputs, digital 1 output + logical operation (including timer)
- (2) Analog 2 inputs, analog 1 output/digital 1 output + numerical operation
- (3) Analog 1 input, digital 1 input, analog 1 output + numerical operation, logical operation

and a total of 200 steps can be used to configure a sequence.

■ Modes

Item	Modes		
	Terminal command	Digital 2 inputs	Analog 2 inputs
Operation block	Logical operation, counter, etc.: 13 types Timer: 5 types	Numerical operation, comparator, limiter, etc.: 25 types	Selector, hold, etc.: 12 types
Output signal	Digital 1 output	Analog 1 output/ Digital 1 output	Analog 1 output
Number of steps	200 steps		
Customizable logic output signal	10 outputs		
Customizable logic processing time	2 ms (max. 10 steps), 5 ms (max. 50 steps), 10 ms (max. 100 steps), 20ms (max. 200 steps) Can be selected with a function code.		
Customizable logic cancellation command "CLC"	Allows to stop all the customizable logic operations by assigning "CLC" to a general-purpose input terminal and turning it ON. It is used when you want to deactivate the customizable logic temporarily.		
Customizable logic timer cancellation command "CLTC"	Resets the timer, counter and all the previous values used in customizable logic by assigning "CLTC" to a general-purpose input terminal and turning it ON. It is used when a customizable logic is changed or if you want to synchronize it with external sequence.		



If you use the customizable logic cancellation command and customizable logic timer cancellation command, the inverter can unintentionally start because the speed command is unmasked, depending on the structure of the customizable logic. Be sure to turn OFF the operation command to turn it ON.

A physical injury may result.

A damage may result.

■ Block diagram

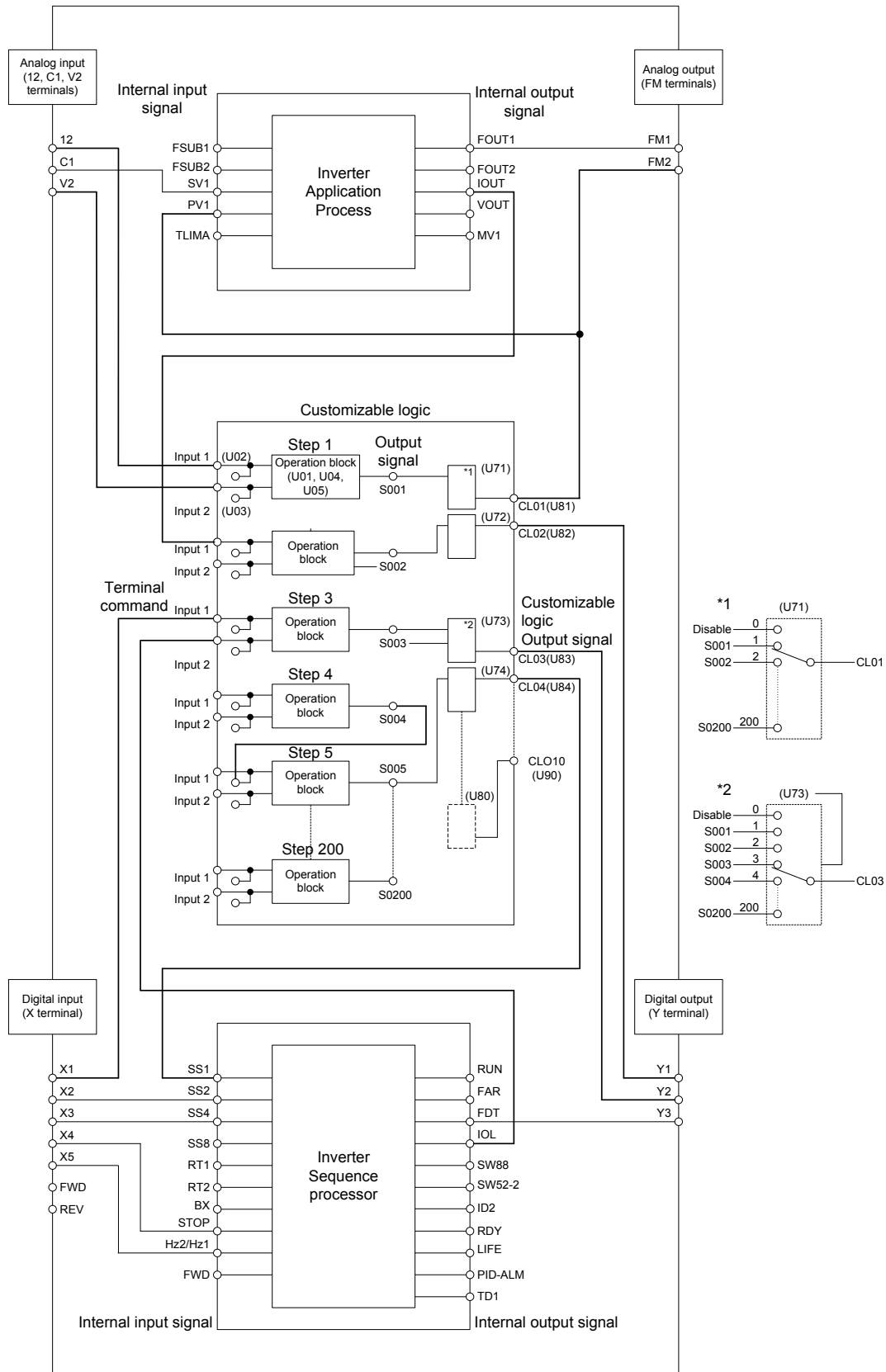

Mode selection function codes for enabling customizable logic can be modified during operation but the customizable logic output may become temporarily unstable due to the setting modification. Therefore, since unexpected operation can be performed, change the settings if possible when the inverter is stopped.

A physical injury may result.

A damage may result.

U00	Customizable logic (Mode selection)
U01 to U70	Customizable logic: Step 1 to 14 (Mode setting)
U71 to U80	Customizable logic: Output signal 1 to 10 (Output selection)
U81 to U90	Customizable logic: Output signal 1 to 10 (Function selection)
U91	Customizable logic: Timer monitor (Step selection)
U92 to U97	Customizable logic: The coefficients of the approximate formula
U100	Customizable logic: Task process cycle setting
U101 to U106	Customizable logic: Operating point 1 to 3
U107	Customizable logic: Auto calculation of the coefficients of the approximate formula
U121 to U140	Customizable logic: User parameter 1 to 20
U171 to U175	Customizable logic: Storage area 1 to 5
U190 to U195	Customizable logic: Step 15 to 200 setting

■ Customizable Logic (Mode selection) (U00)

U00 specifies whether to enable the sequence configured with the customizable logic function or disable it to run the inverter only via its input terminals or others.

U00 data	Function
0	Disable
1	Enable (Customizable logic operation)

The *E_{CL}* alarm occurs when changing U00 from 1 to 0 during operation.

■ Customizable Logic (Mode Setting) (U01 to U70, U190 to U195)

In the customizable logic, the steps are categorized in the following three types:

[Input: digital] Block selection (U01, U06, U11, etc.) = 1 to 1999

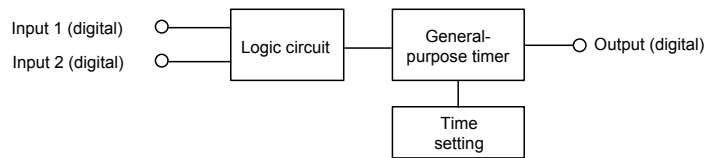

[Input: analog] Block selection (U01, U06, U11, etc.) = 2001 to 3999

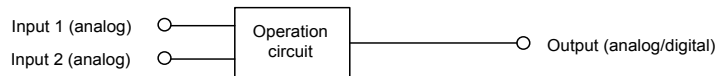

[Input: digital, analog] Block selection (U01, U06, U11, etc.) = 4001 to 5999

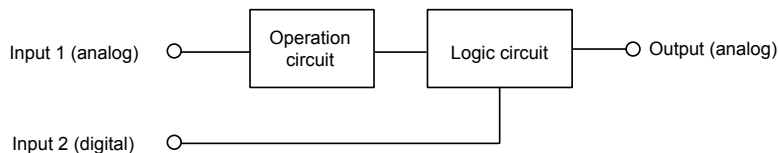

The function code settings for each step are as follows:

- Step 1 to 14

Step No.	Block selection	Input 1	Input 2	Function 1	Function 2	Output ^{Note)}
Step 1	U01	U02	U03	U04	U05	“SO01”
	= 1 to 1999	Digital input 1	Digital input 2	Time setting	Not required	Digital output
	= 2001 to 3999	Analog input 1	Analog input 2	Value 1	Value 2	Analog/digital output
	= 4001 to 6999	Analog input 1	Digital input 2	Value 1	Value 2	Analog output
Step 2	U06	U07	U08	U09	U10	“SO02”
Step 3	U11	U12	U13	U14	U15	“SO03”
Step 4	U16	U17	U18	U19	U20	“SO04”
Step 5	U21	U22	U23	U24	U25	“SO05”
Step 6	U26	U27	U28	U29	U30	“SO06”
Step 7	U31	U32	U33	U34	U35	“SO07”
Step 8	U36	U37	U38	U39	U40	“SO08”
Step 9	U41	U42	U43	U44	U45	“SO09”
Step 10	U46	U47	U48	U49	U50	“SO10”
Step 11	U51	U52	U53	U54	U55	“SO11”
Step 12	U56	U57	U58	U59	U60	“SO12”
Step 13	U61	U62	U63	U64	U65	“SO13”
Step 14	U66	U67	U68	U69	U70	“SO14”

Note) Output is not a function code. It indicates the output signal symbol.

- Step 15 to 200

Specify a step number in U190, and set the block selection, input 1, input 2, function 1, function 2 in U191 to U195 respectively.

Step No.	U190	Block selection	Input 1	Input 2	Function 1	Function 2	Output
Step 15	15	U191	U192	U193	U194	U195	“SO15”
Step 16	16						“SO16”
...
Step 199	199						“SO199”
Step 200	200						“SO200”

[Input: digital] Block function code setting**■ Block selection (U01 etc.) (Digital)**

Any of the following items can be selected as a logic function block (with general-purpose timer):
The data can be logically inverted by adding 1000.

Data	Logic function block	Description
0	No function assigned	Output is always OFF.
10	Through output + General-purpose timer (No timer)	Only a general-purpose timer. No logic function block exists.
11	(On-delay timer)	Turning the input signal ON starts the on-delay timer. When the period specified by the timer has elapsed, the output signal turns ON. Turning the input signal OFF turns the output signal OFF.
12	(Off-delay timer)	Turning the input signal ON turns the output signal ON. Turning the input signal OFF starts the off-delay timer. When the period specified by the timer has elapsed, the output signal turns OFF.
13	(One-shot pulse output)	Turning the input signal ON issues a one-shot pulse whose length is specified by the timer.
14	(Retriggerable timer)	Turning the input signal ON issues a one-shot pulse whose length is specified by the timer. If the input signal is turned ON again during the preceding one-shot pulse length, however, the logic function block issues another one-shot pulse.
15	(Pulse train output)	If the input signal turns ON, the logic function block issues ON and OFF pulses (whose lengths are specified by the timer) alternately and repeatedly. This function is used to flash a luminescent device.
20 to 25	Logical AND + General-purpose timer	AND function with 2 inputs and 1 output, plus general-purpose timer.
30 to 35	Logical OR + General-purpose timer	OR function with 2 inputs and 1 output, plus general-purpose timer.
40 to 45	Logical XOR + General-purpose timer	XOR function with 2 inputs and 1 output, plus general-purpose timer.
50 to 55	Set priority flip-flop + General-purpose timer	Set priority flip-flop with 2 inputs and 1 output, plus general-purpose timer.
60 to 65	Reset priority flip-flop + General-purpose timer	Reset priority flip-flop with 2 inputs and 1 output, plus general-purpose timer.
70, 72, 73	Rising edge detector + General-purpose timer	Rising edge detector with 1 input and 1 output, plus general-purpose timer. This detects the rising edge of an input signal and outputs the ON signal for 5 ms (*1).
80, 82, 83	Falling edge detector + General-purpose timer	Falling edge detector with 1 input and 1 output, plus general-purpose timer. This detects the falling edge of an input signal and outputs the ON signal for 5 ms (*1).
90, 92, 93	Rising & falling edges detector + General-purpose timer	Rising and falling edge detector with 1 input and 1 output, plus general-purpose timer. This detects both the falling and rising edges of an input signal and outputs the ON signal for 5 ms (*1).

*1: Equals the task cycle: 2 ms for a task cycle of 2 ms, 5 ms for 5 ms, 10 ms for 10 ms, and 20 ms for 20 ms.

Data	Logic function block	Description
100 to 105	Hold + General-purpose timer	Hold function of previous values of 2 inputs and 1 output, plus general-purpose timer. If the hold control signal is OFF, the logic function block outputs input signals; if it is ON, the logic function block retains the previous values of input signals.
110	Increment counter	Increment counter with reset input. By the rising edge of the input signal, the logic function block increments the counter value by one. When the counter value reaches the target one, the output signal turns ON. Turning the reset signal ON resets the counter to zero.
120	Decrement counter	Decrement counter with reset input. By the rising edge of the input signal, the logic function block decrements the counter value by one. When the counter value reaches zero, the output signal turns ON. Turning the reset signal ON resets the counter to the initial value.
130	Timer with reset input	Timer output with reset input. If the input signal turns ON, the output signal turns ON and the timer starts. When the period specified by the timer has elapsed, the output signal turns OFF, regardless of the input signal state. Turning the reset signal ON resets the current timer value to zero and turns the output OFF.

The data can be logically inverted by adding 1000.

The block diagrams for individual functions are given below.

(Data=1□) Through output

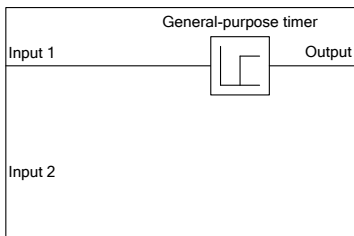

(Data=2□) Logical AND

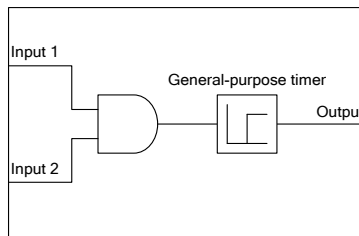

(Data=3□) Logical OR

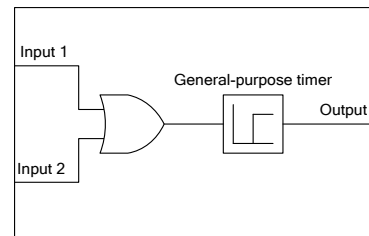

(Data=4□) Logical XOR

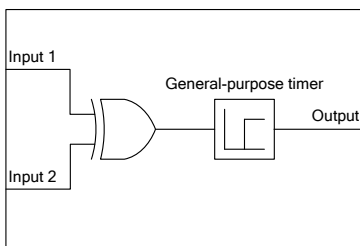

(Data=5□) Set priority flip-flop

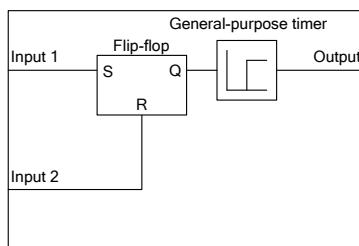

Input 1	Input 2	Previous output	Output	Remarks
OFF	OFF	OFF	OFF	Hold previous value
	ON	ON	ON	
	ON	—	OFF	
ON	—	—	ON	Set priority

(Data=6□) Reset priority flip-flop

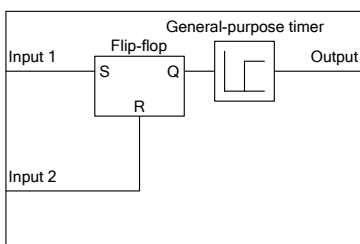

Input 1	Input 2	Previous output	Output	Remarks
OFF	OFF	OFF	OFF	Hold previous value
	ON	ON	ON	
—	ON	—	OFF	Reset priority
ON	OFF	—	ON	

(Data=7□) Rising edge detector

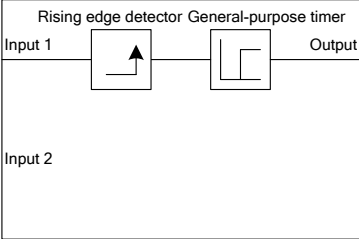

(Data=8□) Falling edge detector

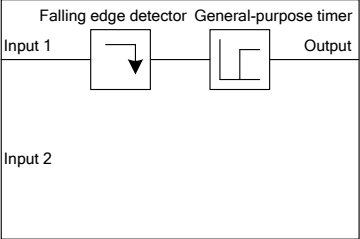

(Data=9□) Rising & falling edges detector

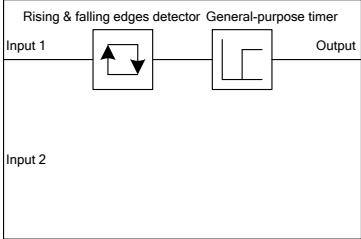

(Data=10□) Hold

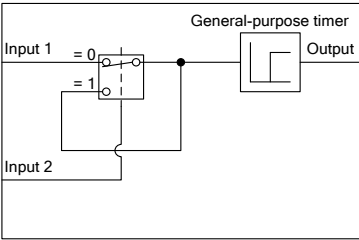

(Data=110) Increment counter

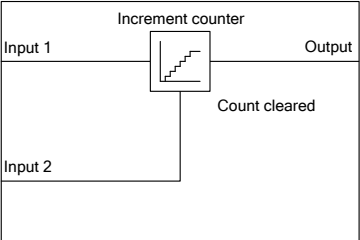

(Data=120) Decrement counter

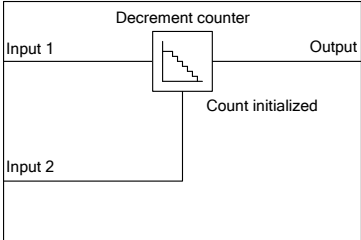

(Data=130) Timer with reset input

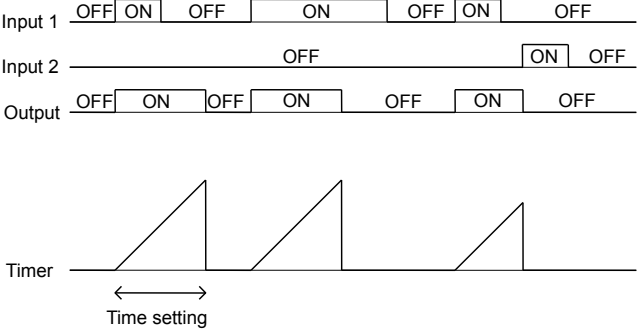
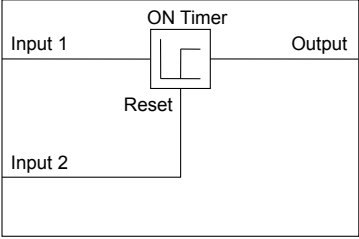

■ Operation of general-purpose timer(Digital)

The operation schemes for individual timers are shown below.

(End 1) On-delay timer

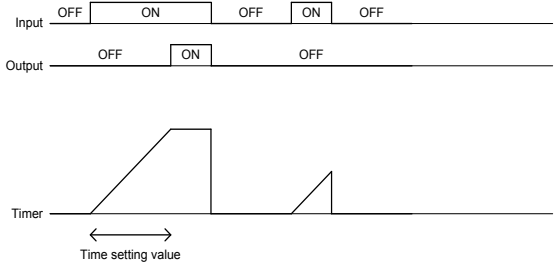

(End 2) Off-delay timer

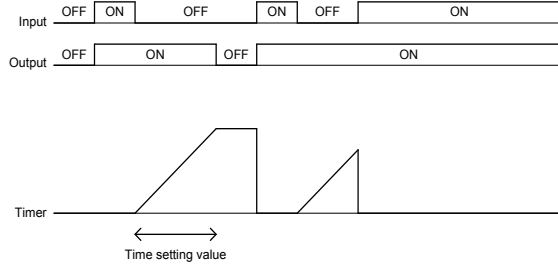

(End 3) One-shot pulse output

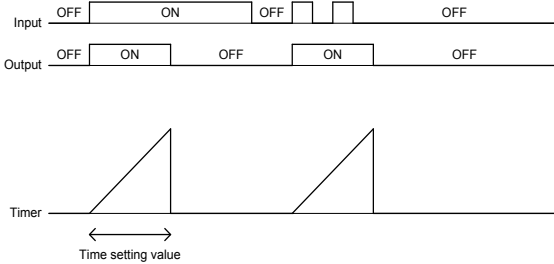

(End 4) Retriggerable timer

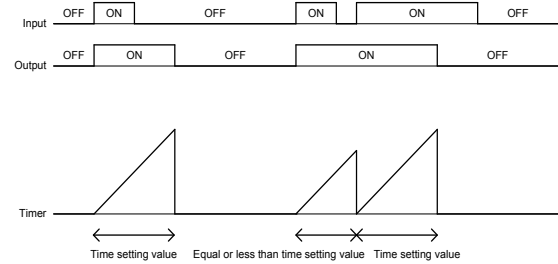

(End 5) Pulse train output

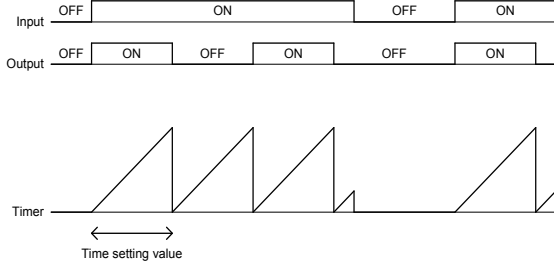

■ **Inputs 1 and 2 (U02, U03, etc.)(Digital)**

The following digital signals are available as input signals. Value in () is in negative logic.

Data	Selectable Signals
0000 (1000) to 0105 (1105)	General-purpose output signals Same as the ones specified by E20, e.g., "RUN" (Inverter running), FAR (Frequency (speed) arrival signal), "FDT" (Frequency (speed) detected), "LU" (Undervoltage detected (Inverter stopped)), "B/D" (Torque polarity detected) Note: 27 (Universal DO) is not available. Note: Customizable logic output signals from 111 (1111) to 120 (1120) cannot be selected.
2001 (3001) to 2200 (3200)	Output of step 1 "SO01" to Output of step 200 "SO200"
4001 (5001)	Terminal X1 input signal "X1"
4002 (5002)	Terminal X2 input signal "X2"
4003 (5003)	Terminal X3 input signal "X3"
4004 (5004)	Terminal X4 input signal "X4"
4005 (5005)	Terminal X5 input signal "X5"
4010 (5010)	Terminal FWD input signal FWD
4011 (5011)	Terminal REV input signal REV
4021 (5021)	Terminal I1 input signal "I1" (on option card, OPC-DIO)
4022 (5022)	Terminal I2 input signal "I2" (on option card, OPC-DIO)
4023 (5023)	Terminal I3 input signal "I3" (on option card, OPC-DIO)
4024 (5024)	Terminal I4 input signal "I4" (on option card, OPC-DIO)
4025 (5025)	Terminal I5 input signal "I5" (on option card, OPC-DIO)
4026 (5026)	Terminal I6 input signal "I6" (on option card, OPC-DIO)
4027 (5027)	Terminal I7 input signal "I7" (on option card, OPC-DIO)
4028 (5028)	Terminal I8 input signal "I8" (on option card, OPC-DIO)
4029 (5029)	Terminal I9 input signal "I9" (on option card, OPC-DIO)
4030 (5010)	Terminal I10 input signal "I10" (on option card, OPC-DIO)
4031 (5011)	Terminal I11 input signal "I11" (on option card, OPC-DIO)
4032 (5012)	Terminal I12 input signal "I12" (on option card, OPC-DIO)
4033 (5013)	Terminal I13 input signal "I13" (on option card, OPC-DIO)
6000 (7000)	Final RUN command "FL_RUN" (ON when a run command is given)
6001 (7001)	Final FWD run command "FL_FWD" (ON when a run forward command is given)
6002 (7002)	Final REV run command "FL_REV" (ON when a run reverse command is given)
6003 (7003)	During acceleration "DACC" (ON during acceleration)
6004 (7004)	During deceleration "DDEC" (ON during deceleration)
6005 (7005)	Under anti-regenerative control "REGA" (ON under anti-regenerative control)
6006 (7006)	Within dancer reference position "DR_REF" (ON when the dancer position is within the reference range)
6007 (7007)	Alarm factor presence "ALM_ACT" (ON when there is no alarm factor)

■ Function 1 (U04 etc.)(Digital)

U05 and other related function codes specify the general-purpose timer period or the increment/decrement counter value.

Data	Function	Description
0.00 to +600.00	Timer	The period is specified in seconds.
	Counter value	The specified value is multiplied by 100 times. (If 0.01 is specified, it is converted to 1.)
-9990.00 to -0.01	—	The timer or counter value works as 0.00. (No timer)
+601.00 to +9990.00	Timer	The period is specified in seconds.

[Input: analog] Block function code setting

■ Block selection, function 1, function 2 (U01, U04, U05, etc.)(Analog)

The following items are available as operation function block.

Note that if the upper and lower limits have the same value, there are no upper and lower limits.

Block selection (U01 etc.)	Function block	Description	Function 1 (U04 etc.)	Function 2 (U05 etc.)
0	No function assigned	This function always outputs 0% (or logical "0: False"; OFF).	Not required	Not required
2001	Adder	Addition function with two inputs (input 1 and input 2). This function has output limiters (upper/lower) specified with two function codes. The 1st function code provides upper limit value and the 2nd one provides lower limit value.	Upper limit	Lower limit
2002	Subtractor	Subtraction function with two inputs (input 1 and input 2). This function has output limiters (upper/lower) specified with two function codes. The 1st function code provides upper limit value and the 2nd one provides lower limit value.	Upper limit	Lower limit
2003	Multiplier	Multiplication function with two inputs (input 1 and input 2). This function has output limiters (upper/lower) specified with two function codes. The 1st function code provides upper limit value and the 2nd one provides lower limit value.	Upper limit	Lower limit
2004	Divider	Division function with two inputs (input 1 and input 2). Input 1 is dividend and input 2 is divisor. This function has output limiters (upper/lower) specified with two function codes. The 1st function code provides upper limit value and the 2nd one provides lower limit value.	Upper limit	Lower limit
2005	Limiter	Upper and lower limit functions of single input (input 1). The 1st function code provides upper limit value and the 2nd one provides lower limit value.	Upper limit	Lower limit
2006	Absolute value of input	Absolute value function of single input (input 1). Negative input numbers become positive. This function has output limiters (upper/lower) specified with two function codes. The 1st function code provides upper limit value and the 2nd one provides lower limit value.	Upper limit	Lower limit

5.3 Description of Function Codes

Block selection (U01 etc.)	Function block	Description	Function 1 (U04 etc.)	Function 2 (U05 etc.)
2007	Inverting adder	Inverting addition function with single input (input 1). This function subtracts the input 1 to the value specified with the 1st function code, inverts the result. And furthermore, the function adds the result to the value specified with the 2nd function code and outputs the result.	Subtraction value (former)	Addition value (latter)
2008	Variable limiter	Variable limit function of single input (input 1). Input 1 provides upper limit value and input 2 provides lower limit value.	Step number	Not required
2009	Linear function	Linear function of single input (input 1). This function receives single input (input 1), calculates pre-defined first-order polynomial, and outputs the result. The 1st and 2nd function codes provide the coefficients of the polynomial. The polynomial is represented by the following formula. $y = K_A \times \chi + K_B$ The output is limited within the range between -9990 and 9990 by the internal limiter.	Factor KA -9990.0 to +9990.0	Factor KB -9990.0 to +9990.0
2051	Comparator 1	Comparison function with hysteresis. This function compares the differential value between input 1 and input 2 with the threshold value specified with the 1st function code. The 2nd function code provides hysteresis width. If the differential value is (threshold value + hysteresis width) or bigger, this function outputs logical "1: True". On the other hand, if the the differential value is (threshold value - hysteresis width) or smaller, this function outputs logical "0: False".	Threshold value	Hysteresis width
2052	Comparator 2	Comparison function with hysteresis. This function compares the differential value between input 1 and input 2 with the threshold value specified with the 1st function code. The 2nd function code provides hysteresis width. If the differential value is bigger than (threshold value + hysteresis width), this function outputs logical "1: True". On the other hand If the value is smaller than (threshold value - hysteresis width), the function outputs logical "0: False".	Threshold value	Hysteresis width
2053	Comparator 3	Comparison function with hysteresis. This function compares the absolute differential value between input 1 and input 2 with the threshold value specified with the 1st function code. The 2nd function code provides hysteresis width. This function works like as comparator 1	Threshold value	Hysteresis width
2054	Comparator 4	Comparison function with hysteresis. This function compares the absolute differential value between input 1 and input 2 with the threshold value specified with the 1st function code. The 2nd function code provides hysteresis width. This function works like as comparator 2	Threshold value	Hysteresis width

Block selection (U01 etc.)	Function block	Description	Function 1 (U04 etc.)	Function 2 (U05 etc.)
2055	Comparator 5	<p>Comparison function with hysteresis.</p> <p>Input 1 is the input value of this function and input 2 is not used.</p> <p>The 1st function code provides threshold value and the 2nd one provides hysteresis width.</p> <p>If input 1 is (threshold value) or bigger, this function outputs logical "1: True". On the other hand If input 1 is smaller than (threshold value - hysteresis width), this function outputs logical "0: False".</p>	Threshold value	Hysteresis width
2056	Comparator 6	<p>Comparison function with hysteresis.</p> <p>Input 1 is the input value of this function and input 2 is not used.</p> <p>The 1st function code provides threshold value and the 2nd one provides hysteresis width.</p> <p>If input 1 is (threshold value) or smaller, this function outputs logical "1: True". On the other hand If input 1 is bigger than (threshold value + hysteresis width), this function outputs logical "0: False".</p>	Threshold value	Hysteresis width
2071	Window comparator 1	<p>Comparison function with limits.</p> <p>Whether the value of the input is within a preselected range specified with two function codes determines the status of the output.</p> <p>Input 1 is the input value of this function and input 2 is not used.</p> <p>The 1st function code provides upper threshold value and the 2nd one provides lower threshold value.</p> <p>If input 1 is within the range (defined with two function codes), this function outputs logical "1: True". On the other hand If input 1 is outside of this range, this function outputs logical "0: False".</p>	Upper threshold	Lower threshold
2072	Window comparator 2	<p>Comparison function with limit.</p> <p>This function has the inverting logic of "Window comparator 1".</p>	Upper threshold	Lower threshold
2101	High selector	<p>High selector function.</p> <p>This function receives two inputs (input 1 and input 2), selects the higher one automatically, and outputs it.</p> <p>This function has output limiters (upper/lower) specified with two function codes.</p> <p>The 1st function code provides the upper limit value and the 2nd one provides the lower one.</p>	Upper limit	Lower limit
2102	Low selector	<p>Low selector function.</p> <p>This function receives two inputs (input 1 and input 2), selects the lower one automatically, and outputs it.</p> <p>This function has output limiters (upper/lower) specified with two function codes.</p> <p>The 1st function code provides the upper limit value and the 2nd one provides the lower one.</p>	Upper limit	Lower limit
2103	Average of inputs	<p>Average function.</p> <p>This function receives two inputs (input 1 and input 2), averages them, and outputs the result.</p> <p>This function has output limiters (upper/lower) specified with two function codes.</p> <p>The 1st function code provides the upper limit value and the 2nd one provides the lower one.</p>	Upper limit	Lower limit

5.3 Description of Function Codes

Block selection (U01 etc.)	Function block	Description	Function 1 (U04 etc.)	Function 2 (U05 etc.)
2151	Loading function from S13	<p>Loading function from the function code S13 with scale conversion function.</p> <p>This function loads the setting value of the function code S13, maps the pre-selected range which is specified with two function codes, and outputs the result.</p> <p>The 1st function code provides the maximum scale value of the range and the 2nd one provides the minimum scale value of the range.</p> <p>The function code S13 is the PID process command value via communications in (%).</p>	Maximum scale	Minimum scale
2201	Clip and map function	<p>This function receives single input (input 1), clips a pre-selected range which is specified with two function codes from it, maps 0.00 to 100.00%, and outputs the result.</p> <p>The 1st function code provides the upper limit value of the range and the 2nd one provides the lower limit value of the range.</p> <p>This function can be connected to analog outputs (8000 to 8021) only, and only two of these functions can be used.</p>	Upper limit	Lower limit
2202	Scale converter	<p>Scale conversion function with single input (input 1).</p> <p>This function receives single input (input 1), maps an pre-selected range which is specified with two function codes, and outputs the result.</p> <p>The 1st function code provides the maximum scale value of the range and the 2nd one provides the minimum scale value of the range.</p> <p>This function can be connected to analog outputs (8000 to 8021) only, and only two of these functions can be used.</p>	Maximum scale	Minimum scale
3001	Quadratic function	<p>Quadratic function with limit.</p> <p>This function receives single input (input 1), calculates pre-defined second-order polynomial represented by the following formula, limits the value, and outputs the result.]</p> $K_A \times (\text{Input } 1)^2 + K_B \times \text{input } 1 + K_C$ <p>The 1st function code provides the upper limit value and the 2nd one provides the lower limit value.</p> <p>The coefficients of the polynomial are given by the function codes U92 to U97.</p> <p>Either (3001) or (3002) is available to use, and only one of these functions can be used.</p>	Upper limit	Lower limit
3002	Square root function	<p>Square root function with limit.</p> <p>This function receives single input (input 1), calculates pre-defined square root function represented by the following formula, limits the value, and outputs the result.</p> $\sqrt{\frac{\text{Input } 1 + K_A}{K_B}} \times K_C$ <p>The 1st function code provides the upper limit value and the 2nd one provides the lower limit value.</p> <p>The coefficients of the polynomial are given by the function codes U92 to U97.</p> <p>Either (3001) or (3002) is available to use, and only one of these functions can be used.</p>	Upper limit	Lower limit

The block diagrams for each operation function block are given below. The setting value for functions 1 and 2 is indicated with U04 and U05.

(2001) Adder

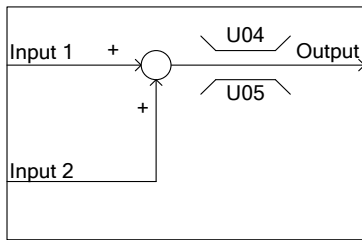

(2002) Subtractor

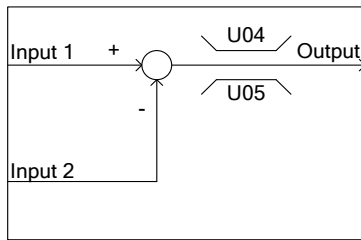

(2003) Multiplier

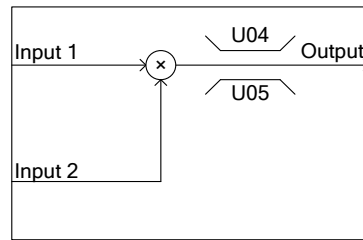

(2004) Divider

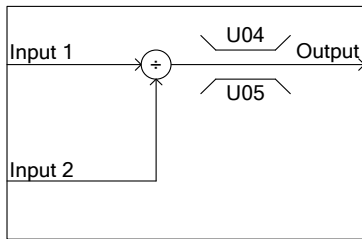

(2005) Limiter

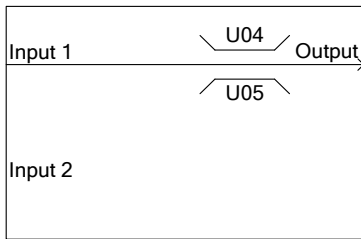

(2006) Absolute value of inputs

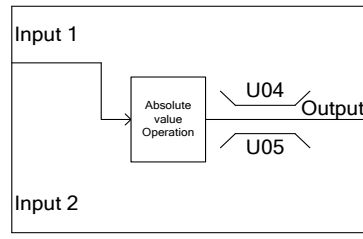

(2007) Inverting adder

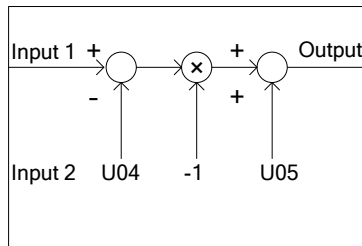

(2009) Linear function

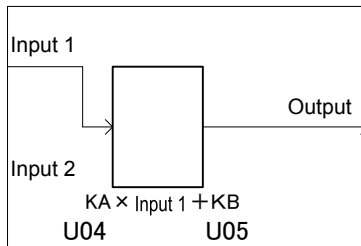

(2051) Comparator 1

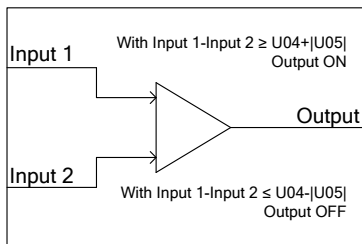

(2052) Comparator 2

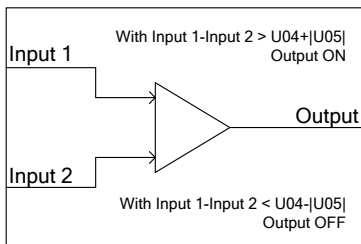

ON is prioritized when both conditions are satisfied.

(2053) Comparator 3

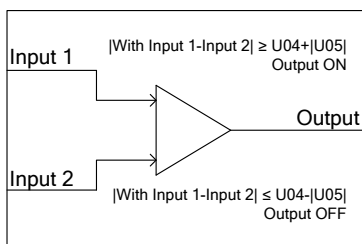

(2054) Comparator 4

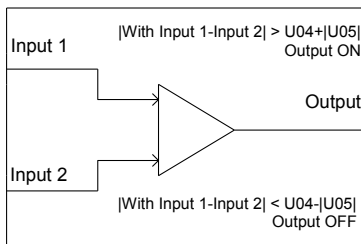

(2055) Comparator 5

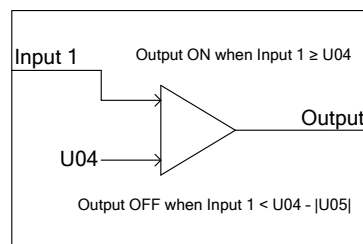

ON is prioritized when both conditions are satisfied.

(2056) Comparator 6

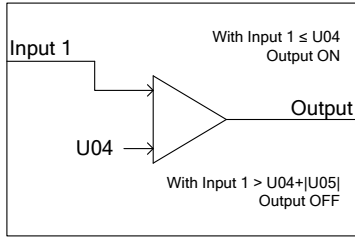

(2071) Window comparator 1

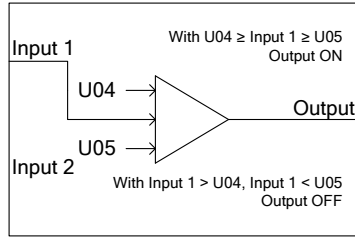

(2072) Window comparator 2

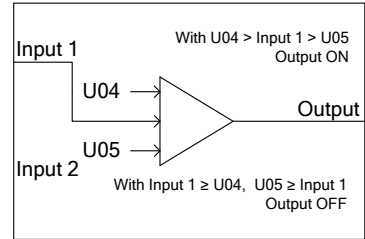

(2101) High selector

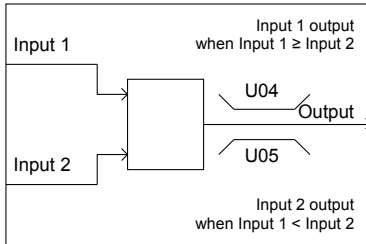

(2102) Low selector

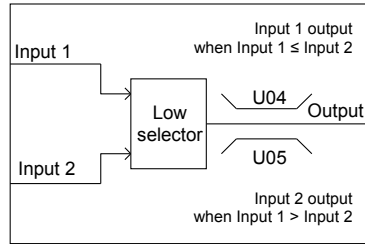

(2103) Average of inputs

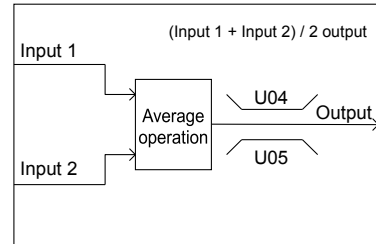

(2151) Loading function from S13

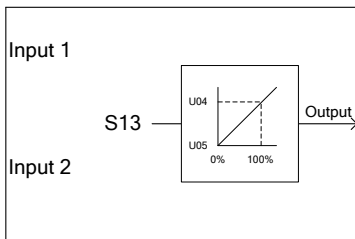

(2201) Clip and map function

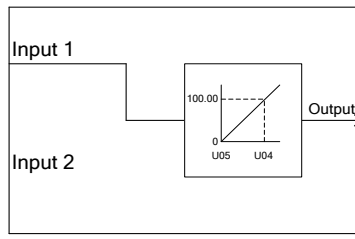

(2202) Scale converter

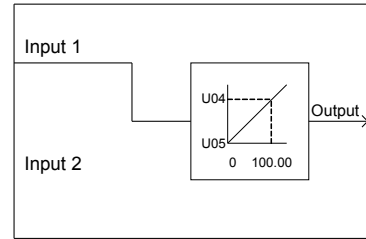

(3001) Quadratic function

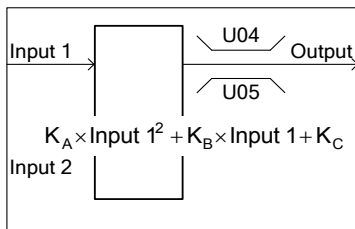

(3002) Square root function

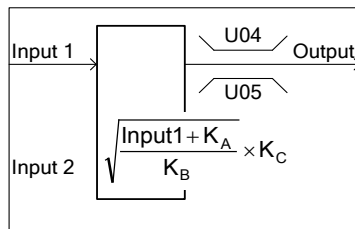

■ Inputs 1 and 2 (U02, U03, etc.)(Analog)

The following signals are available as analog input signals.

Data	Selectable Signals
8000 to 8021	General-purpose analog output signal (same as signals selected in F31 and F35: output frequency 1, output current, output torque, Input power, DC link bus voltage, etc.) Example: For output frequency 1, maximum frequency (100%) is input as 100.00. Example: For output current, 200% of the inverter rated current is input 100.00. Note: 10 (Universal AO) is not available.
2001 to 2200	Output of step 1 to 200 "SO01" to "SO200"
9001	Analog 12 terminal input signal [12]
9002	Analog C1 terminal input signal [C1] (C1 function)
9003	Analog C1 terminal input signal [C1] (V2 function)
9004	Analog 32 terminal input signal [32] (on option card, OPC-AIO)
9005	Analog C2 terminal input signal [C2] (on option card, OPC-AIO)

■ Function 1, Function 2 (U04, U05, etc.)(Analog)

Sets the upper limit and lower limit of operation function block.

Data	Function	Description
-9990.00 to 0.00 to +9990.00	Reference value Hysteresis width Upper limit Lower limit Upper threshold Lower threshold Setting value Maximum scale Minimum scale	Setting values for the operation of the function block (selected with the corresponding function code such as U01).

■ The coefficients of the conversion functions (U92 to U97) (Analog)

Sets the factor of conversions function (3001, 3002) of operation function block.

Function code	Name	Data setting range	Factory default
U92	Mantissa of K_A	Mantissa: -9.999 to 9.999	0.000
U93	Exponent part of K_A	Exponent part: -5 to 5	0
U94	Mantissa of K_B		0.000
U95	Exponent part of K_B		0
U96	Mantissa of K_C		0.000
U97	Exponent part of K_C		0

U92 to U97 can automatically be calculated based on measured data. For details, refer to the descriptions of U101 to U107 (page 5-273).

[Input: digital, analog] Block function code setting**■ Lock selection, function 1, function 2 (U01, U04, U05, etc.) (digital,analog)**

The following items are available as function block.

Note that if the upper and lower limits are identical, there are no upper and lower limits.

Block selection (U01 etc.)	Function block	Description	Function 1 (U04 etc.)	Function 2 (U05 etc.)
4001	Hold	Function to hold analog input 1 based on digital input 1.	Upper limit	Lower limit
4002	Inverting adder with enable	Function to reverse analog input 1 based on digital input 1.	Subtracted value (former)	Addition value (latter)
4003	Selector 1	Function to select analog input 1 and setting value based on digital input 1.	Setting value	Not required
4004	Selector 2	Function to select setting value 1/2 based on digital input 1.	Setting value 1	Setting value 2
4005	LPF (Low pass filter) with enable	Value of an analog input 1 is filtered through LPF (time constant U04) when the digital input 1 is "1". When the digital input 1 is "0", the analog input 1 is directly output. (LPF maintains the previous output value. Therefore, when the digital 1 input changes from 0 to 1, the output will be the value with the previous output value added as the initial value of LPF.) (No upper/lower limiter)	Time constant 0: No filter 0.01 to 5.00s	Fixed as 0
4006	Rate limiter with enable	Value of an analog input is limited with change rate specified in functions 1 and 2 when the digital input 1 is "1". When the digital input 1 is "0", the analog 1 input is directly output. When setting the initial value, carry out an operation with the initial value for input 1 and 0 applied to input 2. Then, reflect the result as the initial value (= previous output value) with 1 applied to input 2. During the initialization or when the CLC terminal is ON, the previous output value is cleared to 0.	Upward change rate Time taken to change 100% 0: No limit 0.01 to 600 s	Downward change rate Time taken to change 100% 0: The same change rate as function 1 0.01 to 600 s
5000	Selector 3	Function to select analog input 2 based on "SO01" to "SO200".	Step No.	Not required
5100	Selector 4	Function to select analog input 1 and "SO01" to "SO200" based on digital input 1.	Step No.	Not required
6001	Reading function codes	Function to read the content of arbitrary function code. Use the 1st function code (such as U04) to specify a function code group, and the 2nd one (such as U05) to specify the last two digits of the function code number. For the function code settings, refer to "■ Configuration of function codes" in page 5-270. Both input 1 and input 2 are not used. Data formats that can be read correctly are as follows (the values are restricted between -9990 and 9990 and, for [29], 20000 is indicated as 100%): [1], [2], [3], [4], [5], [6], [7], [8], [9], [10], [12], [22], [24], [29], [35], [37], [45], [61], [67], [68], [74], [92] and [93] Data formats other than the above cannot be read correctly. Do not use any other format.	0 to 255	0 to 99

Block selection (U01 etc.)	Function block	Description	Function 1 (U04 etc.)	Function 2 (U05 etc.)
6002	Writing function codes	<p>This function writes the value of input 1 to a function code (U171 to U175) on the volatile memory (RAM) when the input 2 becomes "1: True". When the input 2 becomes "0: False", this function stops to write to the function code (U171 to U175) and maintains the previous value. The value of input 1 is stored to the non-volatile memory (EEPROM) when the inverter detects undervoltage.</p> <p>Because the access arbitration from some steps at a time is not possible, only one step is allowed to access to the same function code in the customizable logic. If the access to the target function code from different steps at a time is executed, the alarm is displayed.</p>	39	71 to 75
6003	Temporary change of function code	<p>This function reflects the value of the specified function code on the volatile memory (RAM) when the input 2 becomes "0: False". On the other hand when the input 2 does not become "0: False", this function reflects the value of input 1 in the place of the function code.</p> <p>Refer to "■ Specific function codes" for the applicable function code on page 5-269.</p> <p>The value on the volatile memory (RAM) is cleared when the inverter is powered off.</p> <p>And the value is read from the non-volatile memory and restored when the inverter is powered on.</p> <p>Set the function code group (function type code) to the 1st function code (U04, etc.).</p> <p>Set the lower 2 digits of the function code No. to the 2nd function (U05, etc.).</p> <p>If the specified function code (U04, U05, etc.) is not applicable one, this function outputs zero value.</p> <p>Because the access arbitration from some steps at a time is not possible, only one step is allowed with to access to the same function code in the customizable logic.</p> <p>When the function code is temporarily changed using 6003 during the customize logic operation and if the PC loader is read or copy to the touch panel is performed, the temporary changed data, not the non-volatile memory data, may be copied.</p> <p>Stop the customize logic before these operations.</p>	0 to 255	0 to 99
6101	PID dancer output gain frequency	<p>Circuit to switch either to calculate a frequency correction where 100% of PID output shall be the maximum frequency, or to calculate a frequency correction proportional to the line speed command. Use the input 1 to switch this circuit. Use the input 2 and gain ratio (1st function code) to set the frequency correction.</p> <p>Output: Frequency correction = (PID output) × (Line speed command) ••• (Input 2 OFF, U04≠0%)</p> <p>Frequency correction amount = (PID output × Gain ratio (U04)) × (Maximum output frequency) ••• (Input 2 ON, U04 ≠ 0%) Note that when the gain ratio is set to 0%, the following applies regardless of the input 2:</p> <p>Output: Frequency correction amount = (PID output) × (Line speed command)</p> <p>This circuit is used with the PID control.</p>	Gain ratio 0 to 200%	Lower frequency limit 0 to 500Hz

(4001) Hold

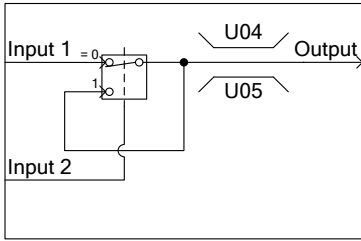

(4002) Inverting adder with enable

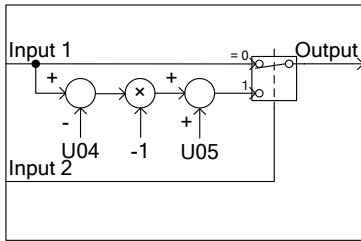

(4003) Selector 1

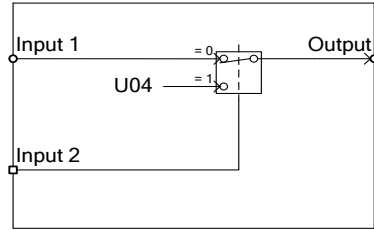

(4004) Selector 2

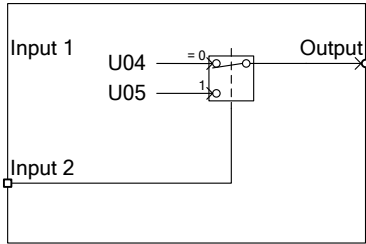

(4005) Low pass filter with enable

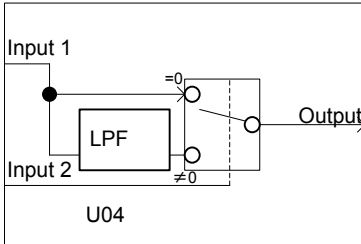

(4006) Rate limiter with enable

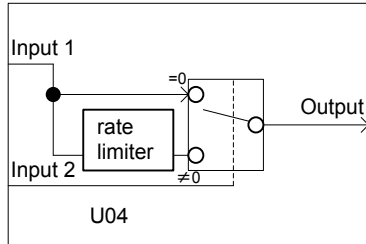

(5000) Selector 3

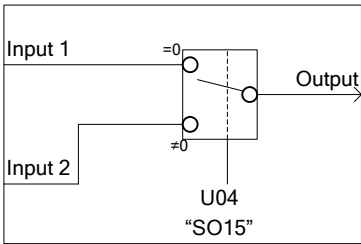

(5100) Selector 4

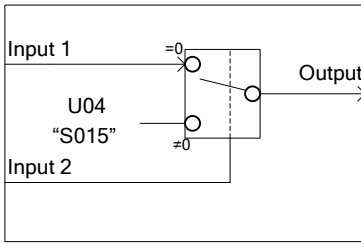

(6001) Reading function codes

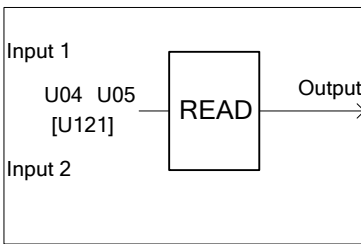

(6002) Writing function codes

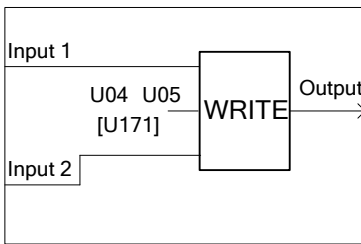

(6003) Temporary change of function code (6101) PID dancer output gain frequency

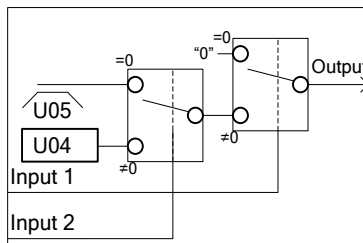
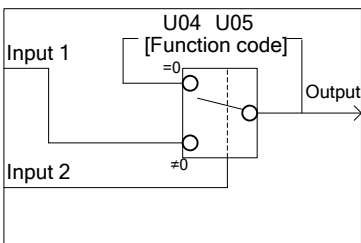

■ Output signal (Digital,analog)

In the customizable logic, outputs from steps 1 to 10 are issued to SO01 to SO200, respectively.

SO01 to SO200 differ in configuration depending upon the connection destination, as listed below. To relay those outputs to any function other than the customizable logic, route them via customizable logic outputs CL01 to CLO10.

Connection destination of each step output	Configuration	Function code
Input of customizable logic	Select one of the internal step output signals "SO01" to "SO200" in customizable logic input setting.	Such as U02 and U03
Input of inverter sequence processor (such as multistep speed "SS1" or operation command "FWD")	Select one of the internal step output signals "SO01" to "SO200" to be connected to customizable logic output signals 1 to 10 ("CL01" to "CLO10").	U71 to U80
	Select an inverter's sequence processor input function to which one of the customizable logic output signals 1 to 10 ("CL01" to "CLO10") is to be connected. (Same as in E01)	U81 to U90
Analog input (such as auxiliary frequency commands or PID process commands)	Select one of the internal step output signals "SO01" to "SO200" to be connected to customizable logic output signals 1 to 10 ("CL01" to "CLO10").	U71 to U80
	Select an analog input function to which one of the customizable logic output signals 1 to 10 ("CL01" to "CLO10") is to be connected. (Same as in E61)	U81 to U90
General-purpose digital output ([Y] terminals)	Select one of the internal step output signals "SO01" to "SO200" to be connected to customizable logic output signals 1 to 10 ("CL01" to "CLO10").	U71 to U80
	To specify a general-purpose digital output function (on [Y] terminals) to which one of the customizable logic output signals 1 to 10 ("CL01" to "CLO10") is to be connected, select one of "CL01" to "CLO10" by specifying the general-purpose digital output function on any Y terminal.	E20, E21, E27
General-purpose analog output ([FM] terminals)	Select one of the internal step output signals "SO01" to "SO200" to be connected to customizable logic output signals 1 to 10 ("CL01" to "CLO10").	U71 to U80
	To specify a general-purpose analog output function (on [FM] terminals) to which one of the customizable logic output signals 1 to 10 ("CL01" to "CLO10") is to be connected, select one of "CL01" to "CLO10" by specifying the general-purpose digital output function on any [FM] terminal.	F31, F35



General-purpose digital outputs (on [Y] terminals) are updated every 5 ms. To securely output a customizable logic signal via [Y] terminals, include on- or off-delay timers in the customizable logic. Otherwise, short ON or OFF signals may not be reflected on those terminals.

5.3 Description of Function Codes

Function codes	Name	Data setting range	Factory default
U71	Customizable logic output signal 1 (Output selection)	0: Disable	0
U72	Customizable logic output signal 2 (Output selection)	1: Output of step 1, "SO01"	0
U73	Customizable logic output signal 3 (Output selection)	2: Output of step 2, "SO02"	0
U74	Customizable logic output signal 4 (Output selection)	...	0
U75	Customizable logic output signal 5 (Output selection)	199: Output of step 199, "SO199"	0
U76	Customizable logic output signal 6 (Output selection)	200: Output of step 200, "SO200"	0
U77	Customizable logic output signal 7 (Output selection)		0
U78	Customizable logic output signal 8 (Output selection)		0
U79	Customizable logic output signal 9 (Output selection)		0
U80	Customizable logic output signal 10 (Output selection)		0
U81	Customizable logic output signal 1 (Function selection)	<p>■ If a step output is digital</p> <p>The same value as E98 can be specified.</p>	100
U82	Customizable logic output signal 2 (Function selection)	0(1000): Select multistep frequency (0 to 1 steps) "SS1"	100
U83	Customizable logic output signal 3 (Function selection)	1(1001): Select multistep frequency (0 to 3 steps) "SS2"	100
U84	Customizable logic output signal 4 (Function selection)	2(1002): Select multistep frequency (0 to 7 steps) "SS4"	100
U85	Customizable logic output signal 5 (Function selection)	3(1003): Select multistep frequency (0 to 15 steps)	100
U86	Customizable logic output signal 6 (Function selection)	4(1004): Select ACC/DEC time (2 steps) "RT1"	100
U87	Customizable logic output signal 7 (Function selection)	5(1005): Select ACC/DEC time (4 steps) "RT2"	100
U88	Customizable logic output signal 8 (Function selection)	6(1006): Enable 3-wire operation "HLD"	100
U89	Customizable logic output signal 9 (Function selection)	7(1007): Coast to a stop command "BX"	100
U90	Customizable logic output signal 10 (Function selection)	8(1008): Reset alarm "RST"	100
		9(1009): Enable external alarm trip "THR"	100
		(9=Active OFF/1009=Active ON)	
		and so on.	
		■ If a step output is analog	
		8001: Auxiliary frequency command 1	100
		8002: Auxiliary frequency command 2	100
		8003: PID process command	100
		8005: PID feedback value	100
		8006: Ratio setting	100
		8007: Analog torque limit value A	
		8008: Analog torque limit value B	
		8009: Analog torque bias	
		8010: Analog torque command	
		8011: Analog torque current command	
		8017: Analog speed limit for forward rotation	
		8018: Analog speed limit for reverse rotation	
		8020: Analog monitor	

■ Specific function codes

The following function codes can take values on memory by using the customizable logic “Function code switch (6003)”. Overwritten values are cleared with power off.

Code	Name	Code	Name
F07	Acceleration time 1	H66	Non-linear V/f 3 (Voltage)
F08	Deceleration time 1	H91	PID feedback wire break detection
F15	Frequency limiter (Upper)	J03	PID control P (Gain)
F16	Frequency limiter (Lower)	J04	PID control I (Integral time)
F21	DC braking 1 (Braking level)	J05	PID control D (Differential time)
F22	DC braking 1 (Braking time)	J06	PID control (Feedback filter)
F23	Starting frequency 1	J10	PID control (Anti-reset windup)
F24	Starting frequency 1 (Holding time)	J12	PID control (Upper limit of warning (AH))
F25	Stop frequency	J13	PID control (Lower limit of warning (AL))
F39	Stop frequency (Holding time)	J15	PID control (Sleep frequency)
F40	Torque limiter 1 (Driving)	J16	PID control (Sleep timer)
F41	Torque limiter 1 (Braking)	J17	PID control (Wakeup frequency)
F44	Current limiter (Level)	J18	PID control (Upper limit of PID process output)
E10	Acceleration time 2	J19	PID control (Lower limit of PID process output)
E11	Deceleration time 2	J58	PID control (Detection width of dancer position error)
E12	Acceleration time 3	J59	PID control P (Gain) 2
E13	Deceleration time 3	J60	PID control I (Integral time) 2
E14	Acceleration time 4	J61	PID control D (Differential time) 2
E15	Deceleration time 4	J62	PID control block selection
C05	Multistep frequency 1	J68	Brake control signal (Brake-release current)
C06	Multistep frequency 2	J69	Brake control signal (Brake-release frequency/speed)
C07	Multistep frequency 3	J70	Brake control signal (Brake-release timer)
C08	Multistep frequency 4	J71	Brake control signal (Brake-apply frequency/speed)
C09	Multistep frequency 5	J72	Brake control signal (Brake-apply timer)
H28	Droop control	J95	Brake control signal (Brake-release torque)
H50	Non-linear V/f 1 (Frequency)	J97	Servo lock (Gain)
H51	Non-linear V/f 1 (Voltage)	d01	Speed control 1 (Speed command filter)
H52	Non-linear V/f 2 (Frequency)	d02	Speed control 1 (Speed detection filter)
H53	Non-linear V/f 2 (Voltage)	d03	Speed control 1 (P (Gain))
H57	1st S-curve acceleration range (At starting)	d04	Speed control 1(I (Integral time))
H58	2nd S-curve acceleration range (At arrival)	d05	Speed control 1 (FF (Gain))
H59	1st S-curve deceleration range (At starting)	d07	Speed control 1 (Notch filter resonance frequency)
H60	2nd S-curve deceleration range (At arrival)	d08	Speed control 1 (Notch filter attenuation level)
H65	Non-linear V/f 3 (Frequency)		

■ Function codes for the customizable logic

Function code number	Name	Range	Minimum unit	Remarks
U121 to U140	User parameter 1 to 20	-9990.00 to 9990.00 Effective number are 3 digits.	0.01 to 10	
U171 to U175	Storage area 1 to 5	-9990.00 to 9990.00 Effective number are 3 digits.	0.01 to 10	Memorize the data when powered off.

■ Configuration of function codes

Set a function code group (code from the following table) to function 1 (such as U04) and set the last two digits of the function code number to function 2 (such as U05) to specify individual function codes.

Group	Code		Name	Group	Code		Name
F	0	00 _H	Basic function	U1	39	27 _H	For customizable logic
E	1	01 _H	Terminal function	y	14	0E _H	Link function
C	2	02 _H	Control function	K	28	1A _H	Touch panel function
P	3	03 _H	Motor1	M	8	08 _H	Monitor data
H	4	04 _H	High performance function	o	6	06 _H	Option function
H1	31	1F _H	High performance function 1	d	19	13 _H	Applied function 2
A	5	05 _H	Speed control 2	U	11	0B _H	Customizable logic
b	18	12 _H	Speed control 3	W	15	0F _H	Monitor 2
r	10	0A _H	Speed control 4	X	16	10 _H	Alarm 1
J	13	0D _H	Applied function 1	Z	17	11 _H	Alarm 2
J1	48	30 _H	Applied function 1				

■ Task process cycle setting (U100)

U100 data	Data
0	Automatically adjusts the task cycle from 2 ms to 10 ms depending on the number of used steps. This is the factory default. It is recommended to use this value.
2	2 ms: Up to 10 steps. If it exceeds 10 steps, the customizable logic does not work.
5	5 ms: Up to 50 steps. If it exceeds 50 steps, the customizable logic does not work.
10	10 ms: Up to 100 steps. If it exceeds 100 steps, the customizable logic does not work.
20	20 ms Up to 200 steps.

Note that if it exceeds the steps defined in 2, 5 or 10, the customizable logic does not work.

■ **Operating precautions**

The customizable logics are executed within 2 ms to 20 ms (according to U100) and processed in the following procedure:

- (1) First, latch the external input signals for all the customizable logics from step 1 to 200 to maintain synchronism.
- (2) Perform logical operations sequentially from step 1 to 200.
- (3) If an output of a step is an input to the next step, outputs of step with high priority can be used in the same process.
- (4) The customizable logic simultaneously updates 10 output signals.

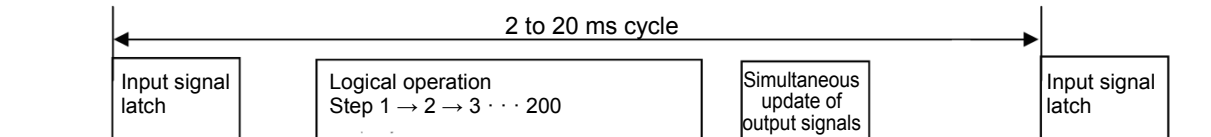

Note that if you do not consider the process order of customizable logic when configuring a function block, the expected output may not be obtained, the operation can be slower or a hazard signal can occur, because the output signal of a step is not available until the next cycle.

⚠ CAUTION

Changing a functional code related to the customizable logic (U code etc.) or turning ON the customizable logic cancel signal “CLC” causes change in operation sequence depending on the setting, which may suddenly start an operation or start an unexpected action. Fully ensure it is safe before performing the operation.

An accident or physical injury may occur.

■ **Customizable logic timer monitor (Step selection) (U91, X89 to X93)**

The monitor function codes can be used to monitor the I/O status or timer’s operation state in the customized logics.

Table 5.3-34 Selection of monitor timer

Function code	Function	Remarks
U91	0: Monitor not active (the monitor data is 0) 1 to 200: set the step No. to monitor	The setting value is cleared to 0 when powered off.

Table 5.3-35 Monitor method

Monitor method	Function code	Data
Communication	X89 customizable logic (digital I/O)	Digital I/O data for the step defined in U91 (only for monitoring)
	X90 customizable logic (timer monitor)	Data of the timer/counter value for the step defined in U91 (only for monitoring)
	X91 customizable logic (analog input 1)	Analog input 1 data for the step defined in U91 (only for monitoring)
	X92 customizable logic (analog input 2)	Analog input 2 data for the step defined in U91 (only for monitoring)
	X93 customizable logic (analog output)	Analog output data for the step defined in U91 (only for monitoring)

■ **Cancel customizable logic “CLC” (function codes E01 to E05 Data = 80)**

Customizable logic operations can temporarily be disabled so that the inverter can be operated without the customizable logic’s logical circuit and timer operation, for example during maintenance.

“CLC”	Function
OFF	Customizable logic enabled (according to U00 setting)
ON	Customizable logic disabled



If you turn ON the customizable logic cancellation signal “CLC”, a sequence by the customizable logic is cleared, which can suddenly start operation depending on the settings. Ensure the safety and check the operation before switching the signal.

■ **Clear all customizable logic timers “CLTC” (function codes E01 to E05 Data = 81)**

If the CLTC terminal function is assigned to a general-purpose input terminal and this input is turn ON, all the general-purpose timers and counters in the customizable logic are reset. It is used to reset and restart the system, when, for example, the timing of external sequence cannot be consistent with internal customizable logic due to a momentary power failure.

“CLTC”	Function
OFF	Normal operation
ON	Resets all the general-purpose timers and counters in the customizable logic. (To reactivate it, turn it OFF again.)

5.3.11 U1 codes (Customizable logic operation)

U101 to U106

Customizable logic
(Operating point 1 (X1, Y1), Operating point 2 (X2, Y2), Operating point 3 (X3, Y3))

By using function block 3001, quadratic function $K_A \cdot x^2 + K_B \cdot x + K_C$ is calculated relative to the input signal x as shown in the following diagram, allowing the output to be obtained. Here, K_A , K_B , and K_C are coefficients, and they can be set with function codes.

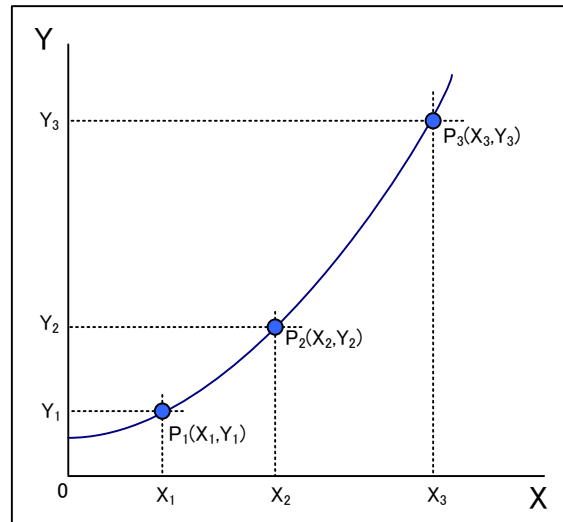

Coefficients K_A , K_B , K_C

Coefficients K_A , K_B , K_C for quadratic function $K_A \cdot x^2 + K_B \cdot x + K_C$ can be set within the following ranges.

	Setting range
Coefficient KA	-9.999×105 to 9.999×105
Coefficient KB	-9.999×105 to 9.999×105
Coefficient KC	-9.999×105 to 9.999×105

These coefficients are set using function codes U92 to U97.

Function code	Name	Setting range
U92	Coefficient KA mantissa portion	-9.999 to 9.999
U93	Coefficient KA exponent portion	-5 to 5
U94	Coefficient KB mantissa portion	-9.999 to 9.999
U95	Coefficient KB exponent portion	-5 to 5
U96	Coefficient KC mantissa portion	-9.999 to 9.999
U97	Coefficient KC exponent portion	-5 to 5

Instead of setting the coefficients individually, they can be calculated and set automatically in function codes U92 to U97, by changing U107 from 0 to 1 after setting the arbitrary three sets of operating point data $P_1 (X_1, Y_1)$, $P_2 (X_2, Y_2)$, and $P_3 (X_3, Y_3)$ from the above diagram in function codes U101 to U106.

Function code	Name	Setting range
U101	Operating point data P1 (X1)	-999.00 to 0.00 to 9990.00
U102	Operating point data P1 (Y1)	999.00 to 0.00 to 9990.00
U103	Operating point data P2 (X2)	999.00 to 0.00 to 9990.00
U104	Operating point data P2 (Y2)	999.00 to 0.00 to 9990.00
U105	Operating point data P3 (X3)	999.00 to 0.00 to 9990.00
U106	Operating point data P3 (Y3)	999.00 to 0.00 to 9990.00
U107	Automatic calculation	0: No calculation, 1: Calculation

U107	Auto calculation of the coefficients of the quadratic function
-------------	---

Set “1” to U107 in order to fit the approximate coefficients of the quadratic function (3001) ($K_A \times \text{Input}1^2 + K_B \times \text{Input}1 + K_C$) to a characteristic represented by three operating points which are given by function codes U101 to U106. Coefficients (K_A, K_B, K_C) of the polynomial are automatically calculated and the results are stored inside the function codes U92 to U97, and U107 reverts to “0”.

U107 data	Function
0	Invalid
1	Execute calculation (to get the coefficients (K_A, K_B, K_C) of the following polynomial $K_A \times \text{Input}1^2 + K_B \times \text{Input}1 + K_C$)

■ **Setting examples of customizable logic**

Setting example 1: Use one switch to change multiple signals

If you use one switch to change the frequency setting 2/frequency setting 1 and torque limit 2/torque limit 1 simultaneously, replace an external circuit that is conventionally needed with a customizable logic reducing the general-purpose input terminals used to a single terminal.

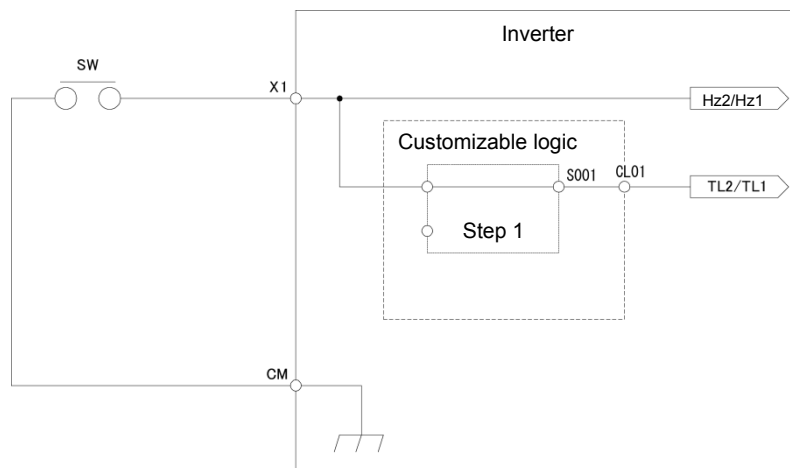

To configure this customizable logic, set the function codes as follows. (Timer selection) and (Timer setting) do not need to be modified if no change is made.

Function code		Setting value	Settings	Remarks	
E01	Terminal [X1] function	11	Select frequency command 2/1 “Hz2/Hz1”	Can be used in parallel as general-purpose input terminals	
U00	Customizable Logic (Mode selection)	1	Enable		
U01	Customizable logic: Step 1	(Block selection)	10	Through output + General-purpose timer	Mode selection
U02		(Input 1)	4001	Terminal [X1] input signal X1	
U71	Customizable logic: Output signal 1	(Output selection)	1	Output of step 1, “SO01”	
U81		(Function selection)	14	Select torque limiter level 2/1 “TL2/TL1”	

Setting example 2: Bring multiple output signals in a single signal

If the general-purpose RUN signal is kept ON at restart after momentary power failure, replace an external circuit that is conventionally needed with a customizable logic sequence to reduce the general-purpose output terminals and external relays.

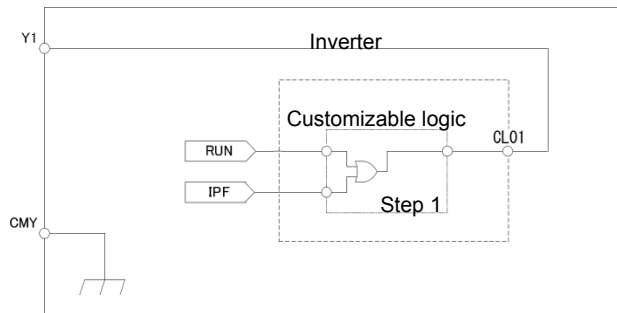

To configure this customizable logic, set the function codes as follows. (Timer selection) and (Timer setting) do not need to be modified if no change is made.

Function code		Setting value	Settings	Remarks	
E20	Terminal [Y1] function	111	Customizable logic output signal 1 "CL01"		
U00	Customizable Logic (Mode selection)	1	Enable		
U01	Customizable logic: Step 1	(Block selection)	30	Logical OR + General-purpose timer	Mode selection
U02		(Input 1)	0	During operation "RUN"	
U03		(Input 2)	6	Auto-restarting after momentary power failure "IPF"	
U71	Customizable logic output signal 1	(Output selection)	1	Output of step 1, "SO01"	
U81		(Function selection)	100	No function assigned "NONE"	

Setting example 3: One-shot operation

The required operation is as follows: SW-FWD or SW-REV switch is short-circuited to start the operation and the SW-STOP switch is short-circuited to stop the operation (equivalent to FWD/REV keys/ STOP key on keypad), if the above operation is required, replace an external circuit that is conventionally needed with customizable the customized logic.

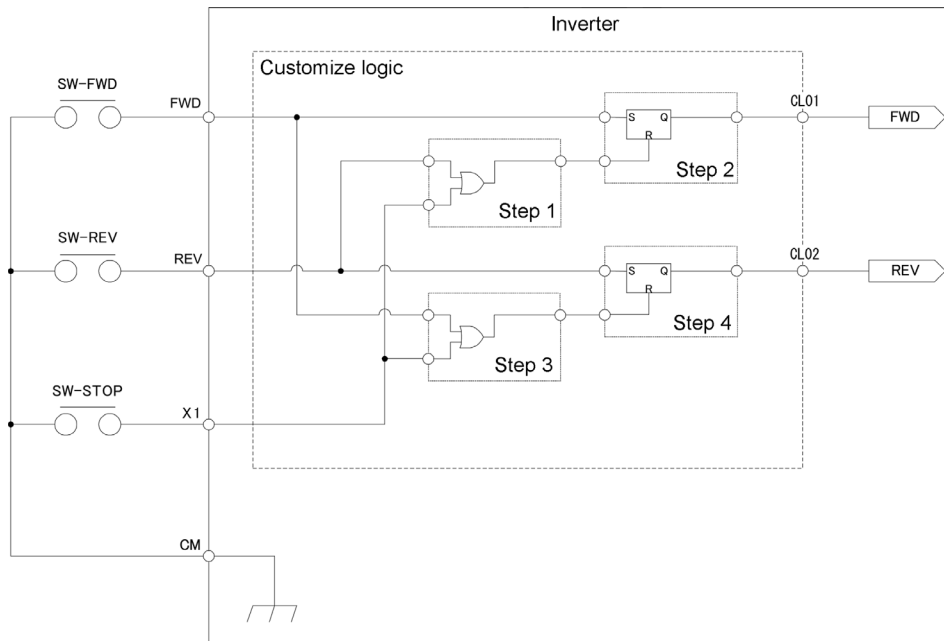

To configure this customizable logic, set the function codes as follows. (Timer selection) and (Timer setting) do not need to be modified if no change is made.

Function code		Setting value	Settings	Remarks	
F02	Operation method	1	External signal		
E01	Terminal [X1] function	100	No function assigned "NONE"		
E98	Terminal [FWD] function	100	No function assigned "NONE"		
E99	Terminal [REV] function	100	No function assigned "NONE"		
U00	Customizable Logic (Mode selection)	1	Enable		
U01	Customizable logic: Step 1	(Block selection)	30	Logical OR + General-purpose timer	Mode selection
U02		(Input 1)	4011	Terminal REV input signal "SW-REV"	
U03		(Input 2)	4001	Terminal X1 input signal "SW-STOP"	
U06	Customizable logic: Step 2	(Block selection)	60	Reset priority flip-flop + General-purpose timer	Mode selection
U07		(Input 1)	4010	Terminal FWD input signal "SW-FWD"	
U08		(Input 2)	2001	Output of step 1 "SO01"	
U11	Customizable logic: Step 3	(Block selection)	30	Logical OR + General-purpose timer	Mode selection
U12		(Input 1)	4010	Terminal FWD input signal "SW-FWD"	
U13		(Input 2)	4001	Terminal X1 input signal "SW-STOP"	
U16	Customizable logic: Step 4	(Block selection)	60	Reset priority flip-flop + General-purpose timer	Mode selection
U17		(Input 1)	4011	Terminal REV input signal "SW-REV"	
U18		(Input 2)	2003	Output of step 3 "SO03"	
U71	Customizable logic output signal 1	(Output selection)	2	Output of step 2 "SO02"	"FWD" command
U72	Customizable logic output signal 2		4	Output of step 4 "SO04"	"REV" command
U81	Customizable logic output signal 1	(Function selection)	98	Run forward/stop command "FWD"	
U82	Customizable logic output signal 2		99	Run reverse/stop command "REV"	

5.3.12 y codes (Link functions)

y01 to y20	RS-485 setting 1, RS-485 setting 2
------------	------------------------------------

In the RS-485 communication, two systems can be connected.

System	Connection method	Function code	Equipment that can be connected
First system	Via RS-485 communication link (port 1) (RJ-45 connector to connect keypad)	y01 to y10	Standard keypad Inverter supporting loader Host equipments (upper equipments)
Second systems	Via RS-485 communications link (port 2) GA model: RJ-45 (shared with CAN communication) GB model and C model (for China): Via digital input terminal blocks (DX+, DX-, SD)	y11 to y20	Host equipments (upper equipments) Inverter supporting loader

Overview of the equipments is given below.

- (1) Standard keypad
Standard keypad can be connected to operate and monitor the inverter.
Regardless of the y code settings, standard keypad is available.
- (2) Inverter supporting loader (FRENIC loader)
Inverter supporting (monitor, function code editing, test operation) can be performed by connecting a computer with the FRENIC loader installed.
 For the y codes setting, refer to the function codes y01 to y10.
- (3) Host equipments (upper equipments)
Host equipments (upper equipments) such as PLC and controller can be connected to control and monitor the inverter. Modbus RTU* protocol or Fuji general-purpose inverter protocol can be selected for communication.

*: Modbus RTU is a protocol defined by Modicon.

 For details, refer to the RS-485 Communication User's Manual.

■ Station addresses (y01, y11)

Set the station addresses for the RS-485 communication. The setting range depends on the protocol.

Protocol	Range	Broadcast
Modbus RTU	1 to 247	0
Protocol for loader commands	1 to 255	—
Fuji general-purpose inverter	1 to 31	99

- When specifying a value out of range, no response is returned.
- The settings to use inverter supporting loader should match with the computer's settings.

■ Communications error processing (y02, y12)

Select an operation when an error occurs in the RS-485 communication.

The RS-485 errors are logical errors such as address error, parity error and framing error, transmission errors and disconnection errors (the latter specified in y08 and y18). These errors occur only when the inverter is configured to receive the operation command or frequency command via the RS-485 communication. If the operation command or frequency command is not issued via the RS-485 communication, or when the inverter is stopped, the system does not determine an error.

y02, y12 data	Function
0	Displays the RS-485 communication error (E_rB for y02, E_rP for y12), and immediately stops the operation (trip by alarm).
1	Operates for a period specified in the error process timer (y03, y13), and then displays the RS-485 communication error (E_rB for y02, E_rP for y12), and stops the operation (trip by alarm).
2	Retries the communication for a period specified in the error process timer (y03, y13), and if the communication is recovered, the operation continues. Displays the RS-485 communication error (E_rB for y02, E_rP for y12) if the communication is not recovered, and immediately stops the operation (trip by alarm).
3	Continues the operation if a communication error occurs.

 For details, refer to the RS-485 Communication User's Manual.

■ Error process timer (y03, y13)

Sets the error process timer, as explained above for the communications error processing parameters (y02, y12). Refer also to the section of disconnection detection time (y08, y18).

- Data setting range: 0.0 to 60.0 (s)

■ Baud rate (y04, y14)

Sets the transmission baud rate.

- For inverter supporting loader (via RS-485):
Match the value with the computer setting.

y04 and y14 data	Function
0	2400 bps
1	4800 bps
2	9600 bps
3	19200 bps
4	38400 bps

■ Data length selection (y05, y15)

Sets the character length.

- For inverter supporting loader (via RS-485):
The value does not need to be set since it automatically becomes 8 bits. (It also applies to Modbus RTU.)

y05 and y15 data	Function
0	8 bits
1	7 bits

■ Parity selection (y06, y16)

Sets the parity.

- For inverter supporting loader (via RS-485):
The value does not need to be set since it automatically becomes even parity.

y06 and y16 data	Function
0	No parity bit (2 bits of stop bit for Modbus RTU)
1	Even parity (1 bit of stop bit for Modbus RTU)
2	Odd parity (1 bit of stop bit for Modbus RTU)
3	No parity bit (1 bits of stop bit for Modbus RTU)

■ **Stop bit selection (y07, y17)**

Sets the stop bit.

- For inverter supporting loader (via RS-485):
The value does not need to be set since it automatically becomes 1 bit.

For Modbus RTU: The value does not need to be set since it is automatically determined in conjunction with the parity bit (function y06, y16).

y07 and y17 data	Function
0	2 bits
1	1 bit

■ **Communication time-out detection timer (y08, y18)**

Sets a period from the time when the system detects communication time-out (for any reason such as disconnection in equipment that periodically access to the station within a specific time) during the operation using the RS-485 communication, until the time when the system processes the communication errors.

For details on processing communication errors, refer to y02 and y12.

y08 and y18 data	Function
0	Disconnection is not detected.
1 to 60	Detection time from 1 to 60 (s)

■ **Response interval time (y09, y19)**

Sets a period from the time when the system receives a request from host equipment (upper equipment such as computer or PLC) until the time when it returns a response. In case of the host equipments that are slow to process the task from completed transmission to completed reception preparation, a timing can be synchronized by setting a response interval time.

- Data setting range: 0.00 to 1.00 (s)

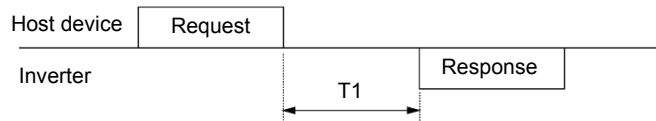

$T1 = \text{Response interval time} + \alpha$

α : Processing time inside the inverter. It varies depending on the timing and command.

📖 For details, refer to the RS-485 Communication User's Manual.



To set an inverter by the inverter supporting loader via the RS-485 communication, consider the performance and condition of the computer and converter (such as USB-RS-485 converter).
(Some converters monitor communication status and switch transmission and reception with timer.)

■ **Protocol selection (y10, y20)**

Selects a communication protocol.

y10 and y20 data	Function
0	Modbus RTU protocol
1	FRENIC Loader protocol
2	Fuji general-purpose inverter protocol

y21 to y36**Built-in CANopen communication setting**

For details, refer to Chapter 9 “9.2 CANopen Communication.”

y95**Data clear processing for communications**

If any of the communication error alarms (E_{r8} , E_{rP} , E_{r4} , E_{r5} , E_{rL}) occurs in RS-485, CANopen communication or bus option, the data of communication command function codes (S codes) can automatically be cleared.

Since the frequency and operation commands are also disabled when the data is cleared, the inverter does not start unintentionally when an alarm is released.



y95 data	Function
0	When a communication error alarm occurs, the function code Sxx data is not cleared (compatible with the conventional mode).
1	When a communication error alarm occurs, the function codes S01, S05 and S19 data is cleared.
2	When a communication error alarm occurs, the bits assigned in function code S06 for operation command is cleared.
3	Clear operations of 1 and 2 above are performed.

y97**Communication data storage selection**

The inverter memory (non-volatile memory) has a limited rewritable times (100 thousand to 1 million times). If the count immoderately increases, the data cannot be modified or saved, causing a memory error.

If the data should frequently be overwritten via communication, it can be written in the temporary memory instead of the non-volatile memory. This allows to save rewritable times to the non-volatile memory, which can avoid a memory error.

If y97 is set to “2”, the data written in the temporary memory is stored (All Saved) in the non-volatile memory.

To change the y97 data, it is necessary to press the  + /  keys (simultaneous keying).

y97 data	Function
0	Store into nonvolatile memory (Rewritable times are limited)
1	Write into temporary memory (Rewritable times are unlimited)
2	Store all data from temporary memory to nonvolatile memory (After storing all data, the y97 data return to 1)

y98**Bus function (Mode selection)****(Refer to H30)**

For details on setting the y98 bus function (mode selection), refer to the description of H30.

y99**Loader link function (Mode selection)**

Function code to switch the links to the inverter supporting loader software (FRENIC Loader). Rewriting y99 with the inverter supporting loader software (FRENIC Loader) enables the frequency command and operation command from the inverter supporting loader software (FRENIC Loader). You do not need to use the keypad since the data is rewritten from the inverter supporting loader.

If the operation command is configured to be given from the inverter supporting loader software, and if the computer starts to go out of control during the operation and a stop command from the loader software is ignored, remove the communication cable connected to the computer that runs the inverter supporting loader software, and connect the keypad to set the y99 data to 0. By setting the y99 data to 0, the operation is isolated from the inverter supporting loader software's commands, switching to the commands of inverter's own settings (such as function code H30).

The y99 data is not saved in the inverter; the setting is lost and returned to 0 when powered off.

y99 data	Function	
	Frequency command	Run command source
0	From function codes H30 and y98	From function codes H30 and y98
1	Command issued from FRENIC loader	From function codes H30 and y98
2	From function codes H30 and y98	Command issued from FRENIC loader
3	Command issued from FRENIC loader	Command issued from FRENIC loader

Chapter 6

TROUBLESHOOTING

This chapter describes troubleshooting procedures to be followed when the inverter malfunctions or detects an alarm or a light alarm condition. In this chapter, first check whether any alarm code or the “light alarm” indication ($L-AL$) is displayed or not, and then proceed to the troubleshooting items.

Contents

6.1	Protective Function	6-1
6.2	Before Proceeding with Troubleshooting	6-2
6.3	If an Alarm Code Appears on the LED Monitor	6-3
6.3.1	Alarm code list	6-3
6.3.2	Causes, checks and measures of alarms	6-6
[1]	<i>LdF</i> PID feedback wire break	6-6
[2]	<i>dbA</i> Braking transistor broken	6-6
[3]	<i>dbH</i> Braking resistor overheat	6-6
[4]	<i>EeF</i> EN circuit failure	6-7
[5]	<i>EeL</i> Customizable logic failure	6-7
[6]	<i>EF</i> Ground fault	6-7
[7]	<i>Er 1</i> Memory error	6-7
[8]	<i>Er 2</i> Keypad communications error	6-8
[9]	<i>Er 3</i> CPU error	6-8
[10]	<i>Er 4</i> Option communications error	6-8
[11]	<i>Er 5</i> Option error	6-8
[12]	<i>Er 6</i> Operation error	6-9
[13]	<i>Er 7</i> Tuning error	6-9
[14]	<i>Er 8</i> RS-485 communications error (Communications port 1)/ <i>Er P</i> RS-485 communications error (Communications port 2)	6-10
[15]	<i>Er d</i> Step-out detection/detection failure of magnetic pole position at startup	6-11
[16]	<i>Er E</i> Speed inconsistency / Excessive speed deviation	6-12
[17]	<i>Er F</i> Data saving error during undervoltage	6-13
[18]	<i>Er H</i> Hardware error	6-13
[19]	<i>Er o</i> Positioning control error	6-13
[20]	<i>Er r</i> Simulated failure	6-14
[21]	<i>Er t</i> CAN communications failure	6-14
[22]	<i>FUS</i> DC fuse-blowing	6-14
[23]	<i>L in</i> Input phase loss	6-15
[24]	<i>LU</i> Undervoltage	6-15

[25]	<i>OLn</i>	Instantaneous overcurrent	6-16
[26]	<i>OH1</i>	Cooling fin overheat	6-17
[27]	<i>OH2</i>	External alarm	6-17
[28]	<i>OH3</i>	Inverter internal overheat	6-17
[29]	<i>OH4</i>	Motor protection (PTC thermistor)	6-18
[30]	<i>OH5</i>	Charging resistor overheat	6-18
[31]	<i>OLn</i>	Motor overloads 1 to 2	6-19
[32]	<i>OLU</i>	Inverter overload	6-20
[33]	<i>OPL</i>	Output phase-failure detection	6-20
[34]	<i>OS</i>	Overspeed protection	6-21
[35]	<i>OLn</i>	Overvoltage	6-21
[36]	<i>PLF</i>	Charge circuit fault	6-22
[37]	<i>PG</i>	PG wire break	6-22
6.4		If the “Light Alarm” Indication (<i>L -FL</i>) Appears on the LED Monitor	6-23
6.5		When Codes Other Than Alarm Codes and Light Alarm Indication (<i>L -FL</i>) are Displayed	6-24
6.5.1		Abnormal motor operation	6-24
[1]		The motor does not rotate	6-24
[2]		The motor rotates, but the speed does not increase	6-26
[3]		The motor runs in the opposite direction to the command	6-27
[4]		Speed fluctuation or current oscillation (e.g., hunting) occurs during running at constant speed	6-28
[5]		Unpleasant noises are emitted from motor or noises fluctuate	6-29
[6]		Motor is not accelerated or decelerated according to set-up acceleration or deceleration times	6-29
[7]		The motor does not restart even after the power recovers from a momentary power failure	6-30
[8]		Motor generates heat abnormally	6-30
[9]		The motor does not run as expected	6-30
[10]		Motor stalls during acceleration	6-31
6.5.2		Problems with inverter settings	6-32
[1]		Nothing appears on the LED monitor	6-32
[2]		The desired menu is not displayed	6-32
[3]		Display of under bars (_ _ _ _)	6-33
[4]		Display of center bars (- - - -)	6-33
[5]		[] Display of parenthesis	6-33
[6]		Data of function codes cannot be changed	6-34
[7]		Function code data are not changeable (change from link functions)	6-34

6.1 Protective Function

In order to prevent system down or to shorten a downtime, FRENIC-Ace is provided with various protective functions shown in Table 6.1-1 below. The protective functions marked with an asterisk (*) in the table are disabled by factory default. Enable them according to your needs.

The protective functions include, for example, the “heavy alarm” detection function which, upon detection of an abnormal state, displays the alarm code on the LED monitor and causes the inverter to trip, the “light alarm” detection function which displays the alarm code but lets the inverter continue the current operation, and other warning signal output functions.

If any problem arises, understand the protective functions listed below and follow the procedures given in Sections 6.2 and onwards for troubleshooting.

Table 6.1-1 Abnormal States Detectable (“Heavy Alarm” and “Light Alarm” Objects)

Protective function	Description	Related function code
“Heavy alarm” detection	This function detects an abnormal state, displays the corresponding alarm code, and causes the inverter to trip. See “Table 6.3-1 Various failure detections (Heavy failure objects)” for alarm codes. For details of each alarm code, see the corresponding item in the troubleshooting in Section 6.3 . The inverter retains the last four alarm codes and their factors together with their running information applied when the alarm occurred, so it can display them.	H98
“Light alarm” detection*	This function detects an abnormal state categorized as a “light alarm,” displays $L-FLL$ and lets the inverter continue the current operation without tripping. Details of light alarms are selectable. Selectable details (codes) are shown in “Table 6.3-1 Various failure detections (Heavy failure objects).” See Section 6.4 for the confirming method and releasing method of the light alarms.	H81 H82
Stall prevention	When the output current exceeds the current limiter level (F44) during acceleration/ deceleration or constant speed running, this function decreases the output frequency to avoid an overcurrent trip.	F44
Overload prevention control*	Before the inverter trips due to a cooling fin overheat ($CH1$) or inverter overload (OLL), this function decreases the output frequency of the inverter to reduce the load.	H70
Anti-regenerative control*	If regenerative energy returned exceeds the inverter's braking capability, this function automatically increases the deceleration time or controls the output frequency to avoid an overvoltage trip.	H69
Deceleration characteristics* (Improvement of braking performance)	During deceleration, this function increases the motor energy loss and decreases the regenerative energy returned to avoid an overvoltage trip (OLV).	H71
Reference loss detection*	This function detects a frequency reference loss (due to a broken wire, etc.), issues the alarm, and continues the inverter operation at the specified frequency.	E65
Automatic lowering of carrier frequency	Before the inverter trips due to an abnormal surrounding temperature or output current, this function automatically lowers the carrier frequency to avoid a trip.	H98
Motor overload early warning*	When the inverter output current has exceeded the specified level, this function issues the “Motor overload early warning” signal before the thermal overload protection function causes the inverter to trip for motor protection (Only for the 1st motor).	E34 E35
Retry*	When the inverter has stopped because of a trip, this function allows the inverter to automatically reset and restart itself. The number of retries and the latency between stop and reset can be specified.	H04 H05
Forced stop*	Upon receipt of the “Force to stop” terminal command STOP, this function interrupts the run and other commands currently applied in order to forcedly decelerate the inverter to a stop state.	H56
Surge protection	This function protects the inverter from a surge voltage between main circuit power lines and the ground.	-
Momentary power failure protection*	<ul style="list-style-type: none"> If a momentary power failure for 15 ms or longer occurs, a protective operation (inverter stop) is activated. When momentary power failure restart is selected, the inverter restarts automatically after voltage restoration within a set-up time (momentary power failure permissible time). 	F14

6.2 Before Proceeding with Troubleshooting

⚠ WARNING

- If any of the protective functions has been activated, first remove the cause. Then, after checking that all run commands are set to OFF, release the alarm. If the alarm is released while any run command is set to ON, the inverter may supply the power to the motor, running the motor.

Injury may occur.

- Even though the inverter has interrupted power to the motor, if the voltage is applied to the main circuit input terminals L1/R, L2/S, L3/T, L1/L and L2/N, voltage may be output to inverter output terminals U, V, and W.
- Turn OFF the power and wait for at least five minutes for inverters with a capacity of FRN0011E2■-7□ / FRN0115E2■-2□ / FRN0072E2■-4□ or below, or at least ten minutes for inverters with a capacity of FRN0085E2■-4□ or above. Make sure that the LED monitor or charging lamp are turned OFF. Further, make sure, using a multimeter or a similar instrument, that the DC intermediate circuit voltage between the terminals P (+) and N (-) has dropped to the safe level (+25 VDC or below).

Electric shock may occur.

Follow the procedure below to solve problems.

- (1) Is wire connection correct?
See Chapter 2 "2.2.1 Basic connection diagram."
- (2) Check whether an alarm code or the "light alarm" indication (I-al) is displayed on the LED monitor.
 - If an Alarm Code Appears on the LED Monitor To Section 6.3
 - If the "Light Alarm" Indication ($\angle -FL$) Appears on the LED Monitor To Section 6.4
 - When Codes Other Than Alarm Codes and Light Alarm Indication ($\angle -FL$) are Displayed To Section 6.5

Abnormal motor operation To Section 6.5.1

- 6.5.1 [1] The motor does not rotate
- 6.5.1 [2] The motor rotates, but the speed does not increase
- 6.5.1 [3] The motor runs in the opposite direction to the command
- 6.5.1 [4] Speed fluctuation or current oscillation (e.g., hunting) occurs during running at constant speed
- 6.5.1 [5] Unpleasant noises are emitted from motor or noises fluctuate
- 6.5.1 [6] Motor is not accelerated or decelerated according to set-up acceleration or deceleration times
- 6.5.1 [7] The motor does not restart even after the power recovers from a momentary power failure
- 6.5.1 [8] Motor generates heat abnormally
- 6.5.1 [9] The motor does not run as expected
- 6.5.1 [10] Motor stalls during acceleration

Problems with inverter settings To Section 6.5.2

- 6.5.2 [1] Nothing appears on the LED monitor
- 6.5.2 [2] The desired menu is not displayed
- 6.5.2 [3] Display of under bars (_ _ _ _)
- 6.5.2 [4] Display of center bars (- - - -)
- 6.5.2 [5] [[]] Display of parenthesis
- 6.5.2 [6] Data of function codes cannot be changed

If any problems persist after the above recovery procedure, contact your Fuji Electric representative.

6.3 If an Alarm Code Appears on the LED Monitor

6.3.1 Alarm code list

When an alarm is detected, check the alarm code displayed on 7-segment LED of keypad.

When one alarm code has more than one cause, alarm subcodes are provided to make it easy to identify the cause. When there is only one cause, the alarm subcode is displayed as “-” and described as “-.”

* See (Chapter 3 “3.4.6 Reading alarm information”) for the method of checking the alarm codes.

* With regard to alarm details having alarm subcodes name “For manufacturer”, inform the alarm subcodes, too, when contacting Fuji Electric or requesting an inverter repair.

Table 6.3-1 Various failure detections (Heavy failure objects)

Alarm code	Alarm code name	Heavy failure object	Light alarm selectable	Retry object	Alarm subcode*	Alarm subcode name	Reference page
<i>E_{oF}</i>	PID feedback wire break	Y	Y	—	—	—	6-6
<i>dbA</i>	Braking transistor broken	Y	—	—	—	—	6-6
<i>dbH</i>	Braking resistor overheat (FRN0115E2■-2□ or below /FRN011E2■-7□ or below /FRN0072E2■-4□ or below)	Y	Y	Y	0	DB resistor overheat	6-6
					1	For manufacturer	
<i>E_{EF}</i>	EN circuit failure	Y	—	—	10	ASIC alarm for functional safety	6-7
					3000	Erroneous detection of STO input	
					Other than above	For manufacturer	
<i>E_{EL}</i>	Customizable logic failure	Y	—	—	—	—	—
<i>E_F</i>	Ground fault (FRN0085E2■-4□ or above)	Y	—	—	—	—	6-7
<i>E_{r1}</i>	Memory error	Y	—	—	1 to 16	For manufacturer	6-7
<i>E_{r2}</i>	Keypad communications error	Y	—	—	1 to 2	For manufacturer	6-8
<i>E_{r3}</i>	CPU error	Y	—	—	1 to 9000	For manufacturer	6-8
<i>E_{r4}</i>	Option communications error	Y	Y	—	1	For manufacturer	6-8
<i>E_{r5}</i>	Option error	Y	Y	—	0	Time-out	6-8
					1 to 10	For manufacturer	
<i>E_{r6}</i>	Operation error	Y	—	—	1	STOP key priority/forced stop (STOP terminal)	6-9
					2	Start check function	
					3	Start check function (when operation is permitted)	
					4	Start check function (when reset is turned on)	
					5	Start check function (when the power recovers in powering on)	
					6	Start check function (TP connection)	
					8 to 14	For manufacturer	

6.3 If an Alarm Code Appears on the LED Monitor

Continuation of Table 6.3-1

Alarm code	Alarm code name	Heavy failure object	Light alarm selectable	Retry object	Alarm subcode*	Alarm subcode name	Reference page
<i>E-r7</i>	Tuning error	Y	—	—	7	Operation command OFF during motor tuning	6-9
					8	Forced stop during motor tuning	
					9	BX command during motor tuning	
					10	Hardware current limit during motor tuning	
					11	Occurrence of low voltage (LV) during motor tuning	
					12	Failure due to prevention of reverse rotation during motor tuning	
					13	Over upper limit frequency during motor tuning	
					14	Switching to commercial power during motor tuning	
					15	Occurrence of alarm during motor tuning	
					16	Change of run command source during motor tuning	
					18	Over acceleration time during motor tuning	
					24	EN terminal failure during motor tuning	
					5000 to 5065	Refer to Chapter 4 “4.8.2 Alarm Information”	
					Other than above	For manufacturer	
<i>E-r8</i>	RS-485 communications error (Communication port 1)	Y	Y	—	—	—	6-10
<i>E-rd</i>	Step-out detection	Y	—	—	5001 to 5008	For manufacturer	6-11
<i>E-rE</i>	Speed inconsistency/ excessive speed deviation	Y	Y	—	1	Signs of speed command and speed detection are inconsistent.	6-12
					3	In the case of excessive speed deviation (detected speed > speed command)	
					5	Detected speed remains 0Hz irrespective of speed command.	
					7	In the case of excessive speed deviation (detected speed < speed command)	
<i>E-rF</i>	Data saving error during undervoltage	Y	—	—	—	—	6-13
<i>E-rH</i>	Hardware error	Y	—	—	—	—	6-13
<i>E-ro</i>	Positioning control error	Y	Y	—	1 to 5	For manufacturer	6-13
<i>E-rP</i>	RS-485 communications error (Communication port 2)	Y	Y	—	—	—	6-11
<i>E-rr</i>	Simulated failure	Y	—	—	—	—	6-14
<i>E-rL</i>	CAN communications failure	Y	—	—	1 to 2	For manufacturer	6-14
<i>F-uS</i>	DC fuse-blowing	Y	—	—	—	—	6-14
<i>L-in</i>	Input phase loss	Y	—	—	1-2	For manufacturer	6-15
<i>LU</i>	Undervoltage	Y	—	—	1	Occurrence of low voltage during gate ON (F14=0)	6-15
					2	Run command ON during low voltage (F14=0, 2)	
					3	LV trip on power recovery from a momentary power failure (F14=1)	
					4 to 5	For manufacturer	

Continuation of Table 6.3-1

Alarm code	Alarm code name	Heavy failure object	Light alarm selectable	Retry object	Alarm subcode*	Alarm subcode name	Reference page
<i>OC1</i>	Instantaneous overcurrent	Y	—	Y	1 to 5001	For manufacturer	6-16
<i>OC2</i>							
<i>OC3</i>							
<i>OH1</i>	Cooling fin overheat	Y	Y	Y	6	Detection of fan stop	6-16
					Other than above	For manufacturer	
<i>OH2</i>	External alarm	Y	Y	—	—	—	6-17
<i>OH3</i>	Inverter internal overheat	Y	Y	Y	0	Internal air overheat	6-17
					1	Charging resistor overheat	
					Other than above	For manufacturer	
<i>OH4</i>	Motor protection (PTC thermistor)	Y	—	Y	—	—	6-18
<i>OH5</i>	Charging resistor overheat	Y	Y	Y	—	—	6-18
<i>OL1</i>	Motor 1 overload	Y	Y	Y	—	—	6-19
<i>OL2</i>	Motor 2 overload	Y	Y	Y	—	—	
<i>OLU</i>	Inverter overload	Y	—	Y	1	IGBT protection	6-20
					2	Inverter overload	
					10	For manufacturer	
<i>OPL</i>	Output phase-failure detection	Y	—	—	1 to 10	For manufacturer	6-20
<i>OS</i>	Overspeed protection	Y	—	—	—	—	6-21
<i>OUI</i>	Overvoltage	Y	—	Y	1 to 12	For manufacturer	6-21
<i>OUI2</i>							
<i>OUI3</i>							
<i>PbF</i>	Charger circuit fault (FRN0203E2 ■-4□ or above)	Y	—	—	1 to 2	For manufacturer	6-22
<i>PG</i>	PG wire break	Y	—	—	10 to 20	For manufacturer	6-22
<i>EnF</i>	Inverter life (Number of startups)	—	Y	—	—	—	6-23
<i>FAL</i>	Detect DC fan lock	—	Y	—	—	—	
<i>LIF</i>	Lifetime alarm	—	Y	—	—	—	
<i>OH</i>	Cooling fin overheat early warning	—	Y	—	—	—	
<i>OL</i>	Overload early warning	—	Y	—	—	—	
<i>Pid</i>	PID alarm output	—	Y	—	—	—	
<i>PTC</i>	PTC thermistor activated	—	Y	—	—	—	
<i>rEF</i>	Reference command loss detected	—	Y	—	—	—	
<i>rFE</i>	Machine life (Cumulative motor running hours)	—	Y	—	—	—	
<i>LFL</i>	Low torque detection	—	Y	—	—	—	

- NB) • If a control power supply voltage drops to such a level that the operation of the inverter control circuit cannot be maintained, all protective functions are automatically reset.
- By OFF → ON operation of  key or X terminal (assigned to RST) the protection stop state can be released. In a state that an alarm cause is not removed, however, resetting operation is not effective.
 - If two or more alarms are occurring, the resetting operation remains ineffective until all the alarm causes are removed. Alarm factors not removed can be checked from the keypad.
 - When assigned to light alarms, “30A/B/C” do not work.

6.3.2 Causes, checks and measures of alarms

[1] *LoF* PID feedback wire break

Phenomena The signal line of PID feedback is broken.

Possible Causes	Check and Measures
(1) The PID feedback signal wire is broken.	Check whether the PID feedback signal wires are connected correctly. → Check whether the PID feedback signal wires are connected correctly. Or, tighten the related terminal screws. → Check whether any contact part bites the wire sheath.
(2) The inverter was affected by strong electrical noise.	Check whether appropriate noise control measures have been implemented (e.g. correct grounding and routing of signal wires, communications cables, and main circuit wires). → Implement noise control measures. → Separate the signal wires from the main power wires as far as possible.

[2] *dbA* Braking transistor broken

Phenomena Faulty operation of the braking transistor was detected.

Possible Causes	Check and Measures
The braking transistor is broken.	Check whether resistance of the braking resistor is correct or there is a misconnection of the resistor. → Consult your Fuji Electric representative for repair.

[3] *dbH* Braking resistor overheat

Phenomena The electronic thermal protection for the braking resistor has been activated.

Possible Causes	Check and Measures
(1) Braking load is too heavy. [Subcode: 0]	Reconsider the relationship between the braking load estimated and the real load. → Lower the real braking load. → Review the selection of the braking resistor and increase the braking capability. Modification of related function codes data (F50, F51, and F52) may be also required.
(2) Specified deceleration time is too short. [Subcode: 0]	Recalculate the deceleration torque and time needed for the load currently applied, based on a moment of inertia for the load and the deceleration time. → Increase the deceleration time (F08, E11, E13, E15, and H56). → Review the selection of the braking resistor and increase the braking capability. Modification of related function codes data (F50, F51, and F52) may be also required.
(3) Incorrect setting of function code data F50, F51, and F52. [Subcode: 0]	Recheck the modes of the braking resistor. → Review data of function codes F50, F51, and F52, then modify them if required.



The inverter issues an overheat alarm of the braking resistor by monitoring the magnitude of the braking load, not by measuring its surface temperature.

When the braking resistor is used so frequently as to exceed the settings made by function codes F50, F51, and F52, therefore, the inverter issues an overheat alarm even if the surface temperature of the braking resistor does not rise. To obtain full performance of the braking resistor, configure function codes F50, F51, and F52 while actually measuring the surface temperature of the braking resistor.

[4] *ECF* **EN circuit failure**

Phenomena Enable circuit state was diagnosed and a circuit failure was detected.

Possible Causes	Check and Measures
(1) Contact defect on interface-PCB [Subcode: 10]	Confirm that the interface-PCB is firmly mounted on the body. ➔ Alarm is released by turning on again.
(2) Enable circuit logic failure [Subcode: 3000]	Confirm that outputs from safety switch etc. are inputted by the same logic (High/High or Low/Low) with EN1 terminal/EN2 terminal. ➔ Alarm is released by turning on again.
(3) A failure (single failure) of enable circuit (safety stop circuit) was detected.	If the circuit failure is not removable by the procedures above, the inverter is out of order. ➔ Contact your Fuji Electric representative.

[5] *ECL* **Customizable logic failure**

Phenomena A setting failure of customizable logic was detected.

Possible Causes	Check and Measures
(1) Setting of the selection of customizable logic operation was changed during operation.	Check whether the selection (Function code U00) of customizable logic operation is changed during operation. ➔ Do not change the selection of customizable logic operation during operation to prevent a danger.



[6] *EF* **Ground fault**

Phenomena A ground fault current flew from the output terminal of the inverter.

Possible Causes	Check and Measures
(1) Inverter output terminal(s) grounded (ground fault).	Disconnect the wiring from the output terminals (U, V, and W) and perform a Megger test. ➔ Remove the grounded parts (including replacement of the wires, relay terminals and motor).

[7] *Er 1* **Memory error**

Phenomena Error occurred in writing the data to the memory in the inverter.

Possible Causes	Check and Measures
(1) When writing data (especially initializing or copying data), the inverter was shut down so that the voltage to the control PCB has dropped.	Initialize data by data initialization (H03), and check whether an alarm can be released by  key after finishing the initialization. ➔ Revert the initialized function code data to their previous settings, then restart the operation.
(2) The inverter was affected by strong electrical noise when writing data (especially initializing).	Check if appropriate noise control measures have been implemented (e.g., correct grounding and routing of control and main circuit wires). Also, perform the same check as described in (1) above. ➔ Implement noise control measures. Revert the initialized function code data to their previous settings, then restart the operation.
(3) The control PCB failed.	Initialize data by data initialization (H03), and check whether an alarm continues even when the release of the alarm is attempted by  key after finishing the initialization. ➔ The control PCB (on which the CPU is mounted) is defective. Contact your Fuji Electric representative.

[8] *Er2* **Keypad communications error**

Phenomena A communications error occurred between the keypad and the inverter.

Possible Causes	Check and Measures
(1) Broken communications cable or poor contact.	Check continuity of the cable, contacts and connections. → Re-insert the connector firmly. → Replace the cable.
(2) Connecting many control wires hinders the front cover from being mounted, lifting the keypad.	Check the mounting condition of the front cover. → Use wires of the recommended size (0.75 mm ²) for wiring. → Change the wiring layout inside the unit so that the front cover can be mounted firmly.
(3) The inverter was affected by strong electrical noise.	Check if appropriate noise control measures have been implemented (e.g., correct grounding and routing of communications cables and main circuit wires). → Implement noise control measures. For details, refer to Appendix A.
(4) A keypad failure occurred.	Replace the keypad with another one and check whether a communications error (<i>Er2</i>) occurs. → Replace the keypad.

[9] *Er3* **CPU error**

Phenomena A CPU error (e.g. erratic CPU operation) occurred.

Possible Causes	Check and Measures
(1) The inverter was affected by strong electrical noise.	Check if appropriate noise control measures have been implemented (e.g. correct grounding and routing of signal wires, communications cables, and main circuit wires). → Implement noise control measures.
(2) The [PLC] and [CM] terminals have been shorted.	Check whether the [PLC] and [CM] terminals have been shorted. (FRN0020E2 ■-2□/ FRN0011E2 ■-7□/ FRN0072E2 ■-4□ or below)

[10] *Er4* **Option communications error**

Phenomena A communications error occurred between the option card and the inverter.

Possible Causes	Check and Measures
(1) There was a problem with the connection between the option card and the inverter.	Check whether the connector on the option card is properly engaged with that of the inverter. → Reload the option card into the inverter.
(2) The inverter was affected by strong electrical noise.	Check whether appropriate noise control measures have been implemented (e.g. correct grounding and routing of signal wires, communications cables, and main circuit wires). → Implement noise control measures.



[11] *Er5* **Option error**

An error detected by the option card.

Refer to the instruction manual of the option card for details.

[12] Er-6 Operation error

Phenomena An incorrect operation was attempted.

Possible Causes	Check and Measures
(1)  key was pressed when the  key is effective (H96=1, 3). [Subcode:1]	Check whether the  key was pressed in a state that a run command is inputted via terminal block or communications. → If this was not intended, check the setting of H96.
(2) The start check function was activated when H96 = 2 or 3. [Subcode:2 to 6]	Check that any of the following operations has been performed with a run command being entered. <ul style="list-style-type: none"> • Power on • Release of alarm • Switching to link operation command → Review the running sequence to avoid input of a Run command when this error occurs. If this was not intended, check the setting of H96. Turn the run command OFF before releasing the alarm.
(3) The forced stop (digital input terminal) STOP was turned OFF. [Subcode:1]	Check that the forced stop "STOP" is turned off. → If this was not intended, check the settings of E01 through E05 for terminals [X1] through [X5].

[13] Er-7 Tuning error

Phenomena Auto-tuning failed.

Possible Causes	Check and Measures
(1) A phase was missing in the connection between the inverter and the motor.	→ Properly connect the motor to the inverter.
(2) V/f or the rated current of the motor was not properly set.	Check whether the data of function codes (F04*, F05*, H50, H51, H52, H53, H65, H66, P02*, P03*) agree with the motor modes.
(3) The wiring length between the inverter and the motor was too long.	Check whether the wiring length between the inverter and the motor exceeds 50 m. Inverters with a small capacity are greatly affected by the wiring length. → Review, and if necessary, change the layout of the inverter and the motor to shorten the connection wire. Alternatively, minimize the wiring length without changing the layout. → Disable both auto-tuning and auto-torque boost (set data of F37* to "1").
(4) The rated capacity of the motor was significantly different from that of the inverter.	Check whether the rated capacity of the motor is three or more ranks lower, or two or more ranks higher than that of the inverter. → Replace the inverter with one with an appropriate capacity. → Set motor constants (P06*, P07*, P08*) manually. → Disable both auto-tuning and auto-torque boost (set data of F37* to "1").
(5) The motor was a special type such as a high-speed motor.	→ Disable both auto-tuning and auto-torque boost (set data of F37* to "1").
(6) Tuning (P04*=2) operation was performed of rotating a motor in a state that brake is applied to the motor.	→ Specify the tuning that does not involve the motor rotation (P04* = 1). → Perform the tuning (P04*=2) with the motor brake released.

[14] *ErB* **RS-485 communications error (Communications port 1)/**
ErP **RS-485 communications error (Communications port 2)**

Phenomena A communications error occurred during RS-485 communications.

Possible Causes	Check and Measures
(1) Communications conditions of the inverter do not match that of the host equipment.	Compare the settings of the function codes (y01 to y10, y11 to y20) with those of the host equipment. → Correct any settings that differ.
(2) Even though no-response error detection time (y08, y18) has been set, communications is not performed within the specified cycle.	Check the host equipment. → Change the settings of host equipment software or disable the no-response error detection (y08, y18 = 0).
(3) The host equipment did not operate due to defective software, settings, or defective hardware.	Check the host equipment (e.g., PLCs and personal computers). → Remove the cause of the equipment error.
(4) The RS-485 converter did not operate due to incorrect connections and settings, or defective hardware.	Check the RS-485 converter (e.g., check for poor contact). → Change the various RS-485 converter settings, reconnect the wires, or replace hardware with recommended devices as appropriate.
(5) Broken communications cable or poor contact.	Check the continuity of the cables, contacts and connections. → Replace the cable.
(6) The inverter was affected by strong electrical noise.	Check if appropriate noise control measures have been implemented (e.g., correct grounding and routing of communications cables and main circuit wires). → Implement noise control measures. → Implement noise reduction measures on the host side. → Replace the RS-485 converter with a recommended insulated one.
(7) Terminating resistor is not properly configured.	Check that the inverter serves as a terminating device in the network. → Set terminal resistor changeover switches for RS-485 communications (SW2/SW6) correctly. In other words, turn the switch(es) to ON if required.

[15] *Err* **Step-out detection/detection failure of magnetic pole position at startup**

Phenomena The step-out of PM motor was detected. The magnetic pole position at startup failed to be detected.

Possible Causes	Check and Measures
(1) Function code settings do not agree with the motor characteristics.	Check whether F04, F05, P01, P02, P03, P60, P61, P62, P63, P64 agree with the motor constants. → Perform auto-tuning of the inverter for every motor to be used.
(2) Magnetic pole position detection method is not appropriate.	Confirm that the magnetic pole position detection mode matches the motor type. → Match the magnetic pole position detection mode selection (P30) to the motor type.
(3) Starting frequency (continuation time) (F24) is insufficient.	Check whether a starting frequency (continuation time) (F24) is set optimally, after setting the magnetic pole position detection mode selection (P30) to "0" or "3." → Set a period of time during which motor can rotate by one or more revolutions. F24 ≥ P01/2/F23 (P01: Number of poles, F23: Starting frequency)
(4) Starting torque is insufficient.	Check the data of acceleration times (F07, E10, E12, E14) and a current command value on a start (P74). → Change the acceleration time to match the load. → Increase the current command value at startup.
(5) Load is small.	Check the data of a reference current at starting (P74). → Decrease the reference current at starting. Set it to 80% or lower when running a motor single unit in a test run etc.



[16] *E-E* **Speed inconsistency / Excessive speed deviation**

Phenomena An excessive deviation appears between the speed command and the detected speed.

Possible Causes	Check and Measures
(1) Incorrect setting of function code data.	Check the motor parameter "Number of poles" (P01*). → Specify the P01* data in accordance with the motor to be used.
(2) Overload.	Measure the inverter output current. → Reduce the load.
	Check whether any mechanical brake is applied. → Release the mechanical brake.
(3) The motor speed does not increase due to the current limiter operation.	Check the data of function code F44 (Current limiter (Level)). → Change the F44 data correctly. Or, set the F43 data to "0" (Disable) if the current limiter operation is not needed.
	Check the data of the function codes (F04*, F05*, P01*-P12*) to see if V/f is set correctly. → Match the V/f pattern setting with the motor ratings. → Change the function code data in accordance with the motor parameters.
(4) Function code settings do not match the motor characteristics.	Confirm that P01*, P02*, P03*, P06*, P07*, P08*, P09*, P10*, P12* match the motor constants. → Perform auto-tuning of the inverter, using the function code P04*.
(5) Wiring to the motor is incorrect.	Check the wiring to the motor. → Connect the inverter output terminals U, V, and W to the motor input terminals U, V, and W, respectively.
(6) The motor speed does not increase due to the torque limiter operation.	Check the data of F40 (Torque limiter (Level)). → Change the F40 data correctly. Or, set the F40 data to "999" (Disable) if the torque limiter operation is not needed.
(7) The wire between the pulse generator (PG) and the option card is broken or incorrect.	Check whether the pulse generator (PG) is correctly connected to the option card or any wire is broken. → Check whether the PG is connected correctly. Or, tighten the related terminal screws. → Check whether any contact part bites the wire sheath. → Replace the wire.

[17] E_rF Data saving error during undervoltage

Phenomena The inverter failed to save data such as the frequency commands and PID commands (which are specified through the keypad), or the output frequencies modified by the UP/DOWN signal commands when the power was turned OFF.

Possible Causes	Check and Measures
(1) During data saving performed when the power was turned OFF, the voltage fed to the control PCB dropped in an abnormally short period due to the rapid discharge of the DC intermediate circuit.	Check how long it takes for the DC intermediate circuit voltage to drop to the preset voltage when the power is turned OFF. → Remove whatever is causing the rapid discharge of the DC intermediate circuit voltage. After pressing the  key and releasing the alarm, return the data of the relevant function codes (such as the frequency commands and PID commands (specified through the keypad) or the output frequencies modified by the UP/DOWN signal commands) back to the original values and then restart the operation.
(2) The inverter operation was affected by strong electrical noise during data saving performed when the power was turned OFF.	Check if appropriate noise control measures have been implemented (e.g., correct grounding and routing of control and main circuit wires). → Implement noise control measures. After pressing the  key and releasing the alarm, return the data of the relevant function codes (such as the frequency commands and PID commands (specified through the keypad) or the output frequencies modified by the UP/DOWN signal commands) back to the original values and then restart the operation.
(3) The control circuit failed.	Check if E_rF occurs each time the power is turned ON. → The control PCB (on which the CPU is mounted) is defective. Contact your Fuji Electric representative.

[18] E_rH Hardware error

Phenomena Faulty contact of the connector connecting the control and power printed circuit boards was detected.

Possible Causes	Check and Measures
(1) The control printed circuit board is misconnected to the power printed circuit board.	It is necessary to replace the power or control printed circuit board. → Contact your Fuji Electric representative.



[19] E_rO Positioning control error

Phenomena Excessive position deviation occurred on servo lock / position control.

Possible Causes	Check and Measures
(1) Insufficient gain in positioning control system (servo lock)	Readjust the settings of J97 (Servo lock (Gain)) and d03 (Speed control 1 P (Gain)).
(2) Incorrect control completion width (servo lock)	Check whether the setting of J99 (Servo lock (Completion range)) is correct. → Correct the setting of J99.
(3) Position deviation is excessive. (servo lock)	Check whether the excessive error detection level (d78) is set up properly.
(4) Position deviation is excessive. (position control)	The position feedback pulses are not received. → Check whether the PG is connected correctly. Or, tighten the related terminal screws. → Check whether any contact part bites the wire sheath. → Replace the wire / pulse generator.

[20] Err Simulated failure

Phenomena The LED displays the alarm *Err*.

Possible Causes	Check and Measures
(1) Keep  key +  key pressed for five seconds or longer.	➔ To escape from this alarm state, press the  key.

[21] Err CAN communications failure

Phenomena Communications error occurred in CAN bus communications.

Possible Causes	Check and Measures
(1) Baud rate settings differ.	Check the data of baud rate (y24) and setting details of host equipment side. ➔ Correct any settings that differ.
(2) Defect of host controllers (including programmable controller, personal computer, etc.) (Defects of control software, setting and hardware)	Check the host equipment. ➔ Remove the cause of the equipment error.
(3) Break and contact failure of communications cables	Check the continuity of the cables, contacts and connections. ➔ Replace the cable.
(4) The inverter was affected by strong electrical noise.	Check if appropriate noise control measures have been implemented (e.g., correct grounding and routing of communications cables and main circuit wires). ➔ Implement noise control measures. ➔ Implement noise reduction measures on the host side.

[22] FUS DC fuse-blowing

Phenomena The fuse inside the inverter blew.

Possible Causes	Check and Measures
(1) The fuse blew due to short-circuiting inside the inverter.	Check whether there has been any excess surge or noise coming from outside. ➔ Take measures against surges and noise. ➔ Consult your Fuji Electric representative for repair.

[23]  **Input phase loss**

Phenomena Input phase loss occurred, or interphase voltage unbalance rate was large.
If the auxiliary power (R0, T0) is taken from the breaker primary side (power supply side), a “L U7” alarm may occur even if there has been no phase loss.

Possible Causes	Check and Measures
(1) Breaks in wiring to the main power input terminals.	Measure the input voltage. → Repair or replace the main circuit power input wires or input devices (MCCB, MC, etc.).
(2) The screws on the main power input terminals are loosely tightened.	Check if the screws on the main power input terminals have become loose. → Tighten the terminal screws to the recommended torque.
(3) Interphase voltage unbalance among three phases was too large.	Measure the input voltage. → Connect an AC reactor (ACR) to lower the voltage unbalance between input phases. → Increase the inverter capacity.
(4) Overload cyclically occurred.	Measure the ripple wave of the DC intermediate circuit voltage. → If the ripple is large, increase the inverter capacity.
(5) Single-phase voltage was input to the three-phase input inverter.	Check the inverter type. → Apply three-phase power.



The input phase loss protection can be disabled with the function code H98.

[24]  **Undervoltage**

Phenomena DC intermediate circuit voltage has dropped below the undervoltage detection level.

Possible Causes	Check and Measures
(1) A momentary power failure occurred. [Subcode:1] [Subcode:3]	→ Release the alarm. → If you want to restart running the motor without treating this condition as an alarm, set F14 to “3,” “4,” or “5,” depending on the load type.
(2) The power to the inverter was switched back to ON too soon (when F14 = 1). [Subcode:2]	Check if the power to the inverter was switched back to ON while the control power was still alive. Check whether the LEDs on the keypad are lit. → Turn the power ON again after all LEDs on the keypad go off.
(3) The power supply voltage did not reach the inverter's type correct range.	Measure the input voltage. → Increase the voltage to within the specified range.
(4) Peripheral equipment for the power circuit malfunctioned, or the connection was incorrect.	Measure the input voltage to find which peripheral equipment malfunctioned or which connection is incorrect. → Replace any faulty peripheral equipment, or correct any incorrect connections.
(5) Any other loads connected to the same power supply has required a large starting current, causing a temporary voltage drop.	Measure the input voltage and check the voltage fluctuation. → Reconsider the power supply system configuration.
(6) Inverter's inrush current caused the power voltage drop because the power supply transformer capacity was insufficient.	Check if the alarm occurs when a molded case circuit breaker (MCCB), earth leakage circuit breaker (ELCB) (with overcurrent protection) or magnetic contactor (MC) is turned ON. → Reconsider the capacity of the power supply transformer.

[25] *OCn* **Instantaneous overcurrent**

Phenomena The inverter momentary output current exceeded the overcurrent level.

- OC1* Overcurrent occurred during acceleration.
OC2 Overcurrent occurred during deceleration.
OC3 Overcurrent occurred during running at constant speed.

Possible Causes	Check and Measures
(1) The inverter output lines were short-circuited.	Disconnect the wiring from the inverter output terminals (U, V and W) and measure the interphase resistance of the motor wiring. Check if the resistance is too low. → Remove the short-circuited part (including replacement of the wires, relay terminals and motor).
(2) Ground faults have occurred at the inverter output lines.	Disconnect the wiring from the output terminals (U, V, and W) and perform a Megger test. → Remove the grounded parts (including replacement of the wires, relay terminals and motor).
(3) Overload.	Measure the motor current with a measuring device to trace the current trend. Then, use this data to judge if the trend is over the calculated load value for your system design. → If the load is too heavy, reduce it or increase the inverter capacity. Trace the current trend and check if there are any sudden changes in the current. → If there are any sudden changes, make the load fluctuation smaller or increase the inverter capacity. → Enable instantaneous overcurrent limiting (H12 = 1).
(4) Excessive torque boost specified. The manual torque boost is set if F37* = 0, 1, 3, or 4.	Check whether decreasing the torque boost (F09*) decreases the output current but does not stall the motor. → If no stall occurs, decrease the torque boost (F09*).
(5) The specified acceleration/ deceleration time was too short.	Check that the motor generates enough torque required during acceleration/deceleration. That torque is calculated from the moment of inertia of the load and the acceleration/deceleration times. → Increase the acceleration/deceleration times (F07, F08, E10 through E15, and H56). → Enable the current limiter (F43) and torque limiter (F40, F41, E16, and E17). → Increase the inverter capacity.
(6) Malfunction caused by noise.	Check if appropriate noise control measures have been implemented (e.g., correct grounding and routing of control and main circuit wires). → Implement noise control measures. For details, refer to Appendix A. → Enable the retry function (H04). → Connect a surge absorber to magnetic contactor's coils or other solenoids (if any) causing noise.
(7) Motor is idling at start-up.	When the motor is idling at high speed, an excessive current flow during start-up. → Enable auto search (H09/d67).
(8) The [PLC] and [CM] terminals have been shorted.	Check whether the [PLC] and [CM] terminals have been shorted. (FRN0020E2■-2□/ FRN0011E2■-7□/ FRN0072E2■-4□ or below)

[26] *OH1* **Cooling fin overheat**

Phenomena Temperature around heat sink has risen abnormally.

Possible Causes	Check and Measures
(1) The surrounding temperature exceeded the inverter's mode limit.	Measure the surrounding temperature. → Lower the temperature (e.g., ventilate the panel where the inverter is mounted).
(2) Ventilation paths are blocked.	Check if there is sufficient clearance around the inverter. → Change the mounting place to ensure the clearance.
	Check if the fin is not clogged. → Clean the fin.
(3) Cooling fan's airflow volume decreased due to the service life expired or failure.	Check the cumulative run time of the cooling fan. (See Chapter 3 "3.4.5 Reading maintenance information.") → Replace the cooling fan.
[Subcode:6]	Visually check that the cooling fan rotates normally. → Replace the cooling fan.
(4) Overload.	Measure the inverter output current. → Reduce the load. Reduce the load before reaching an overload using cooling fin overheat forecast (E01-E05)/overload forecast (E34). → Decrease the motor sound (Carrier frequency (F26)). → Enable overload prevention control (H70).

[27] *OH2* **External alarm**Phenomena External alarm was inputted (THR).
(when the "Enable external alarm" signal THR has been assigned to any of digital input terminals)

Possible Causes	Check and Measures
(1) An alarm function of external equipment was activated.	Check the operation of external equipment. → Remove the cause of the alarm that occurred.
(2) Wrong connection or poor contact in external alarm signal wiring.	Check if the external alarm signal wiring is correctly connected to the terminal to which the "external alarm" has been assigned (Any of E01 to E05, E98, and E99 should be set to "9"). → Connect the external alarm signal wire correctly.
(3) Incorrect setting of function code data.	Check whether an "external alarm" is assigned to a terminal not used yet among E01 to E05, E98, E99. → Correct the assignment.
	Check whether the logic of [THR] set up at E01 to E05, E98, E99 agrees with that (positive/negative) of external signals. → Ensure the matching of the logic.

[28] *OH3* **Inverter internal overheat**

Phenomena Temperature inside the inverter has exceeded the allowable limit.

Possible Causes	Check and Measures
(1) The surrounding temperature exceeded the inverter's mode limit. [Subcode:0]	Measure the surrounding temperature. → Lower the temperature around the inverter (e.g., ventilate the panel where the inverter is mounted).

[29] *OH4* **Motor protection (PTC thermistor)**

Phenomena Temperature of the motor has risen abnormally.

Possible Causes	Check and Measures
(1) The temperature around the motor exceeded the motor's mode range.	Measure the surrounding temperature. → Lower the temperature around the motor.
(2) Cooling system for the motor is defective.	Check if the cooling system of the motor is operating normally. → Repair or replace the cooling system of the motor.
(3) Overload.	Measure the inverter output current. → Reduce the load (e.g. Use the overload early warning (E34) and reduce the load before the overload protection is activated.). In winter, the load tends to increase. → Lower the temperature around the motor. → Increase the Carrier frequency (function code F26).
(4) The activation level (H27) of the PTC thermistor for motor overheat protection was set inadequately.	Check the PTC thermistor modes and recalculate the detection voltage. → Modify the data of function code H27.
(5) The setting of the PTC thermistor is not adequate.	Check thermistor Mode selection (H26, E59) and the changeover switches (SW3, SW4) of terminal [C1]. → Change the settings to E59=0, H26=1, and set SW3 to C1 side and SW4 to PTC side.
(6) Excessive torque boost specified (F09*)	Check whether decreasing the torque boost (F09*) does not stall the motor. → If no stall occurs, decrease the F09* data.
(7) The V/f pattern did not match the motor.	Check if the base frequency (F04*) and the rated voltage at base frequency (F05*) match the rated values on the motor's nameplate. → Match the function code data with the values on the motor's nameplate.
(8) Incorrect setting of function code data.	Although PTC thermistor is not used, the thermistor Mode selection (H26) is set to the operation state. → Set the H26 data to "0" (Disable).

[30] *OH6* **Charging resistor overheat**

Phenomena Temperature of the charging resistor inside the inverter has risen abnormally.

Possible Causes	Check and Measures
(1) The inverter power is turned ON and OFF frequently.	Suppress the inverter power ON/OFF cycles. → Turn ON and OFF the inverter power once or less per 30 min.
(2) The inverter power is not turned ON and OFF frequently.	Check that this alarm always occurs when the inverter power is turned ON. → The charging circuit of the inverter is faulty. Consult your Fuji Electric representative for repair.

[31] *OLn* **Motor overloads 1 to 2**

Phenomena Electronic thermal function for motor overload detection of motors 1-2 worked.

OL1 Motor 1 overload

OL2 Motor 2 overload

Possible Causes	Check and Measures
(1) The electronic thermal characteristics do not match the motor overload characteristics.	Check the motor characteristics. → Review the data of related function codes P99*, F10*, F12*. → Use an external thermal relay.
(2) Activation level for the electronic thermal protection was inadequate.	Check the continuous allowable current of the motor. → Reconsider and change the data of function code F11*.
(3) The specified acceleration/ deceleration time was too short.	Recalculate the acceleration/deceleration torque and time needed for the load, based on the moment of inertia of the load and the acceleration/deceleration times. → Increase the acceleration/deceleration times (F07, F08, E10 to E15, and H56).
(4) Overload.	Measure the inverter output current. → Reduce the load (e.g. Use the overload early warning (E34) and reduce the load before the overload protection is activated.). In winter, the load tends to increase.
(5) Excessive torque boost specified (F09*)	Check whether decreasing the torque boost (F09*) does not stall the motor. → If no stall occurs, decrease the F09* data.

[32] *OLU* **Inverter overload**

Phenomena Temperature inside inverter has risen abnormally.

Possible Causes	Check and Measures
(1) The surrounding temperature exceeded the inverter's mode limit.	Measure the surrounding temperature. → Lower the temperature (e.g., ventilate the panel where the inverter is mounted).
(2) Excessive torque boost specified (F09*)	Check whether decreasing the torque boost (F09*) does not stall the motor. → If no stall occurs, decrease the F09* data.
(3) The specified acceleration/ deceleration time was too short.	Recalculate the acceleration/deceleration torque and time needed for the load, based on the moment of inertia of the load and the acceleration/deceleration times. → Increase the acceleration/deceleration times (F07, F08, E10 to E15, and H56).
(4) Overload.	Measure the inverter output current. → Reduce the load (e.g. Use the overload early warning (E34) and reduce the load before the overload protection is activated.). In winter, the load tends to increase. → Decrease the Carrier frequency (function code F26). → Enable overload prevention control (H70).
(5) Ventilation paths are blocked.	Check if there is sufficient clearance around the inverter. → Change the mounting place to ensure the clearance.
	Check if the fin is not clogged. → Clean the fin.
(6) Cooling fan's airflow volume decreased due to the service life expired or failure.	Check the cumulative run time of the cooling fan. See Chapter 3 "3.4.5 Reading maintenance information." → Replace the cooling fan.
	Visually check that the cooling fan rotates normally. → Replace the cooling fan.
(7) The wires to the motor are too long, causing a large leakage current from them.	Measure the leakage current. → Insert an output circuit filter (OFL).

[33] *OPL* **Output phase-failure detection**

Phenomena Output phase loss occurred.

Possible Causes	Check and Measures
(1) Inverter output wires are broken.	Measure the inverter output current. → Replace the output wires.
(2) The motor winding is broken.	Measure the inverter output current. → Replace the motor.
(3) The terminal screws for inverter output were not tight enough.	Check if any screws on the inverter output terminals have become loose. → Tighten the terminal screws to the recommended torque.
(4) A single-phase motor has been connected.	→ The inverter cannot be used. FRENIC-Ace has been designed for driving 3-phase induction / permanent magnet synchronous motors.

[34] *OS* **Overspeed protection**Phenomena Motor rotated at excessive speed (When motor speed \geq (F03 \times 1.2)).

Possible Causes	Check and Measures
(1) Incorrect setting of function code data.	Check the motor parameter "Number of poles" setting (P01*). → Specify the P01* data in accordance with the motor to be used.
	Check the maximum frequency setting (F03*). → Specify the F03* data in accordance with the output frequency.

[35] *OLn* **Overvoltage**

Phenomena The DC intermediate circuit voltage was over the detection level of overvoltage.

OL1 Overvoltage occurred during acceleration.*OL2* Overvoltage occurred during deceleration.*OL3* Overvoltage occurred during running at constant speed.

Possible Causes	Check and Measures
(1) The power supply voltage exceeded the inverter's mode range.	Measure the input voltage. → Decrease the voltage to within the specified range.
(2) A surge current entered the input power supply.	In the same power line, if a phase-advancing capacitor is turned ON/OFF or a thyristor converter is activated, a surge (momentary large increase in the voltage or current) may be caused in the input power. → Install a DC reactor.
(3) The deceleration time was too short for the moment of inertia of the load.	Recalculate the deceleration torque based on the moment of inertia of the load and the deceleration time. → Increase the deceleration time (F08, E11, E13, E15, and H56). → Enable the anti-regenerative control (H69), or deceleration characteristics (H71). → Set torque limit (F40, F41, E16, E17) to become effective. → Set the rated voltage at base frequency (F05*) to "0" to improve the braking capability. → Consider the use of a braking resistor.
(4) The acceleration time was too short.	Check if the overvoltage alarm occurs after rapid acceleration. → Increase the acceleration time (F07, E10, E12, and E14). → Select the Curve acceleration/ deceleration (H07). → Consider the use of a braking resistor.
(5) Braking load is too heavy.	Compare the braking torque of the load with that of the inverter. → Set the rated voltage at base frequency (F05*) to "0" to improve the braking capability. → Consider the use of a braking resistor.
(6) Malfunction caused by noise.	Check if the DC intermediate circuit voltage was below the protective level when the overvoltage alarm occurred. → Implement noise control measures. For details, refer to Appendix A. → Enable the retry function (H04). → Connect a surge absorber to magnetic contactor's coils or other solenoids (if any) causing noise.

[36] *PbF* **Charge circuit fault**

Phenomena The magnetic contactor for short-circuiting the charging resistor failed to work.

Possible Causes	Check and Measures
(1) The control power was not supplied to the magnetic contactor intended for short-circuiting the charging resistor.	<p>Check that, in normal connection of the main circuit (not a connection via the DC link bus), the connector (CN R) on the power printed circuit board (power PCB) is not inserted to NC.</p> <p>→ Insert the connector (CN R) to FAN.</p>
	<p>Check whether you quickly turned the circuit breaker ON and OFF to confirm safety after cabling/wiring.</p> <p>→ Wait until the DC intermediate circuit voltage has dropped to a sufficiently low level and then release the current alarm. After that, turn ON the power again. Do not turn the circuit breaker ON and OFF quickly.</p> <p>(Turning ON the circuit breaker supplies power to the control circuit to the operation level (lighting the LEDs on the keypad) in a short period. Immediately turning it OFF even retains the control circuit power for a time, while it shuts down the power to the magnetic contactor intended for short-circuiting the charging resistor since the contactor is directly powered from the main power. Under such conditions, the control circuit can issue a turn-on command to the magnetic contactor, but the contactor without power cannot operate normally. This state is regarded as abnormal, causing an alarm.)</p>

[37] *PG* **PG wire break**

Phenomena The pulse generator (PG) wire has been broken somewhere in the circuit.

Possible Causes	Check and Measures
(1) Not assigned "PIN" under positioning control with pulse counter.	<p>Check whether a "Pulse train input [PIN]" is assigned to E05.</p> <p>→ Correct the assignment.</p>
(2) PG(Z phase) wire break under master-follower operation.	<p>Check whether the pulse generator (PG) is correctly connected to the option card or any wire is broken.</p> <p>→ Check whether the PG is connected correctly. Or, tighten the related terminal screws.</p> <p>→ Check whether any contact part bites the wire sheath.</p> <p>→ Replace the wire(s).</p>
(3) The inverter was affected by strong electrical noise.	<p>Check whether appropriate noise control measures have been implemented (e.g. correct grounding and routing of signal wires, communications cables, and main circuit wires).</p> <p>→ Implement noise control measures.</p> <p>→ Separate the control circuit wires from the main power wires as far as possible.</p>

6.4 If the “Light Alarm” Indication (L -AL) Appears on the LED Monitor

If the inverter detects a minor abnormal state, it can continue the current operation without tripping while displaying the “light alarm” indication (L -AL) on the LED monitor. In addition to the indication I-al, the inverter blinks the KEYPAD CONTROL LED and outputs the “light alarm” signal L-ALM to a digital output terminal to alert the peripheral equipment to the occurrence of a light alarm. To use the L-ALM signal, it is necessary to assign this signal to any of the digital output terminals by setting any of function codes E20 to E21 and E27 to “98.”

Function codes H81 and H82 specify which alarms should be categorized as “light alarm.” Selectable factors (codes) are the codes of light alarm objects shown in Table 6.3-1.

To display the “light alarm” factor and escape from the light alarm state, follow the instructions below.



■ Check method of light alarm factors

- 1) Press the  key to enter Programming mode.
- 2) Check the light alarm factor in $S_{-}35$ (Light alarm factor (latest)) under Menu #5 “Maintenance Information” in Programming mode. The light alarm factor is displayed in alarm codes. See Table 6.3-1 for code details.

 See Chapter 3 “3.4.5 Reading maintenance information” for the details of screen transition in the “Maintenance Information.” It is possible to display the factors of most recent 3 light alarms in $S_{-}37$ (Light alarm factor (last)) to $S_{-}39$ (Light alarm factor (3rd last)).

■ Switching the LED monitor from the light alarm to normal display

If it is necessary to return the LED monitor to the normal display state (showing the running status such as reference frequency) temporarily before removing the light alarm factor because it takes a long time to remove the light alarm factor, for example, follow the steps below.

- 1) Press the  key to return the LED monitor to the light alarm indication (L -AL).
- 2) Press  key in a state of light alarm display (L -AL). Keypad display returns from light alarm display (L -AL) to monitor display (including frequency display) in the ordinary running state. KEYPAD CONTROL LED continues blinking, though.

■ Release method of light alarms

- 1) See function codes (H81, H82) corresponding to light alarm factors (codes) checked in the Maintenance Information to remove the occurrence factors of light alarms.
- 2) To return the LED monitor from the L -AL display to the normal display state (showing the running status such as reference frequency), press the  key in Running mode.

If the light alarm factor(s) has been successfully removed in step 1) above, the KEYPAD CONTROL LED stops blinking and the digital output L-ALM also goes OFF. If any light alarm factor persists (e.g., detecting a DC fan lock), the KEYPAD CONTROL LED continues blinking and the L-ALM remains ON.

6.5 When Codes Other Than Alarm Codes and Light Alarm Indication ($\angle -FL$) are Displayed

This section describes the troubleshooting procedure based on function codes dedicated to motor 1. When motor 2 is used, it is necessary to convert to the corresponding function codes. The function codes that need to be converted are marked with “*.”

 For the function codes to be converted, see Chapter 5 “FUNCTION CODES.”

6.5.1 Abnormal motor operation

[1] The motor does not rotate

Possible Causes	Check and Measures
(1) No power supplied to the inverter.	<p>Check the input voltage and interphase voltage unbalance.</p> <ul style="list-style-type: none"> ➔ Switch on the molded-case circuit breaker, an earth-leakage circuit breaker (with overcurrent protective function) or a magnetic contactor. ➔ Check for voltage drop, phase loss, poor connections, or poor contacts, and fix them if necessary. ➔ If only the auxiliary control power input is supplied, also supply the main power to the inverter.
(2) No forward/reverse operation command was inputted, or both the commands were inputted simultaneously (external signal operation).	<p>Check the input status of the forward/reverse command with Menu “I/O Checking” using the keypad.</p> <ul style="list-style-type: none"> ➔ Input a run command. ➔ Set either the forward or reverse operation command to OFF. ➔ Correct the run command source. Set F02 data to “1.” ➔ Correct the assignment error of terminals [FWD], [REV]. (E98, E99) ➔ Connect the external circuit wires to control circuit terminals [FWD] and [REV] correctly. ➔ Make sure that the sink/source slide switch (SW1) on the control printed circuit board (control PCB) is properly configured.
(3) No rotational direction is instructed. (Keypad operation)	<p>Check the input status of the forward/reverse rotation direction command with Menu “I/O Checking” using the keypad.</p> <ul style="list-style-type: none"> ➔ Input the rotation direction (F02 = 0), or select the keypad operation with which the rotation direction is fixed (F02 = 2 or 3).
(4) The inverter could not accept any run commands from the keypad since it was in Programming mode.	<p>Check which operation mode the inverter is in, using the keypad.</p> <ul style="list-style-type: none"> ➔ Shift the operation mode to Running mode and enter a run command.
(5) A run command with higher priority than the one attempted was active, and the run command was stopped.	<p>Based on the run command block diagram (See Chapter 8 “BLOCK DIAGRAMS FOR CONTROL LOGIC”), check a higher priority run command by function code data check and I/O checking from Menu using the keypad.</p> <ul style="list-style-type: none"> ➔ Correct any incorrect function code data settings such as link function (Mode selection) (H30) and bus link function (Mode selection) (y98) or cancel the higher priority run command.
(6) No analog frequency command input.	<p>Check that a reference frequency has been entered correctly, using Menu “I/O Checking” on the keypad.</p> <ul style="list-style-type: none"> ➔ Connect external circuit wirings of terminals [13], [12], [11], [C1] correctly.

6.5 When Codes Other Than Alarm Codes and Light Alarm Indication (\underline{L} - \overline{FL}) are Displayed

Possible Causes	Check and Measures
(7) The reference frequency was below the starting or stop frequency.	<p>Check that a reference frequency has been entered correctly, using "I/O Checking" from the Menu on the keypad.</p> <ul style="list-style-type: none"> ➔ Set the reference frequency at the same or higher value than that of the starting and stop frequencies (F23* and F25). ➔ Reconsider the starting and stop frequencies (F23* and F25), and if necessary, change them to lower values. ➔ Inspect the external frequency command potentiometers, signal converters, switches, and relay contacts. Replace any ones that are faulty. ➔ Connect external circuit wiring of terminals [13], [12], [11], [C1] correctly.
(8) A frequency command with higher priority than the one attempted was active.	<p>Based on the frequency setting block diagram (See Chapter 8 "BLOCK DIAGRAMS FOR CONTROL LOGIC"), check the data by function code data check and I/O checking from Menu using the keypad.</p> <ul style="list-style-type: none"> ➔ Correct any incorrect function code data (e.g. cancel the higher priority run command).
(9) The upper and lower frequencies for the frequency limiters were set incorrectly.	<p>Check the data of function codes F15 (Frequency limiter (High)) and F16 (Frequency limiter (Low)).</p> <ul style="list-style-type: none"> ➔ Change the settings of F15 and F16 to the correct ones.
(10) The coast-to-stop command was effective.	<p>Check the data of the function codes (E01 to E05, E98, E99), and check the input state by using "I/O Checking" from the Menu on the keypad.</p> <ul style="list-style-type: none"> ➔ Release the coast-to-stop command setting.
(11) Broken wires, incorrect connection or poor contact with the motor.	<p>Check the wiring (Measure the output current).</p> <ul style="list-style-type: none"> ➔ Repair the wires to the motor, or replace them.
(12) Overload.	<p>Measure the inverter output current.</p> <ul style="list-style-type: none"> ➔ Reduce the load (In winter, the load tends to increase.) <p>Check whether any mechanical brake is applied.</p> <ul style="list-style-type: none"> ➔ Release the mechanical brake.
(13) Torque generated by the motor was insufficient.	<p>Check that the motor starts running if the value of the torque boost (F09*) is increased.</p> <ul style="list-style-type: none"> ➔ Increase the value of torque boost (F09*). <p>Check the data of function codes (F04*, F05*, H50, H51, H52, H53, H65, and H66).</p> <ul style="list-style-type: none"> ➔ Change the V/f pattern to match the motor's characteristics. <p>Check that the motor switching signal (selecting motor 1 - 2) is correct and the data of function codes matches each motor.</p> <ul style="list-style-type: none"> ➔ Correct the motor switching signal. ➔ Modify the function code data to match the connected motor. <p>Check whether the reference frequency is below the slip frequency of the motor.</p> <ul style="list-style-type: none"> ➔ Change the reference frequency so that it becomes higher than the slip frequency of the motor.
(14) Wrong connection or poor contact of DC reactor (DCR)	<p>Check the wiring. DC reactor must be used with inverters of ND modes: FRN0139E2■-4□ or above and HD, HND modes: FRN0168E2■-4□ or above, HHD modes FRN203E2■-4□ or above respectively. These inverters cannot run without a DCR.</p> <ul style="list-style-type: none"> ➔ Connect the DCR correctly. Repair or replace DCR wires.
(15) No speed command is set (Keypad operation).	<p>Check a speed set value of keypad.</p> <ul style="list-style-type: none"> ➔ Press  key to change the speed set value.

6.5 When Codes Other Than Alarm Codes and Light Alarm Indication ($\underline{L} - \underline{F}_L$) are Displayed

Possible Causes	Check and Measures
(16) No enable inputs [EN1], [EN2] are entered.	<p>Check the EN terminal input state by using "I/O Checking" from the Menu on the keypad.</p> <p>➔ Connect the terminals [EN1], [EN2]. See Chapter 2 "2.2.6 [3] Description of terminal functions" [EN1], [EN2].</p>

[2] The motor rotates, but the speed does not increase

Possible Causes	Check and Measures
(1) The maximum frequency currently specified was too low.	<p>Check the data of function code F03* (Maximum frequency).</p> <p>➔ Correct the F03* data.</p>
(2) The data of frequency limiter (Upper limit) currently specified was too low.	<p>Check the data of function code F15 (Frequency limiter (Upper limit)).</p> <p>➔ Correct the F15 data.</p>
(3) Speed setting is not changing (Analog setting).	<p>Check that the reference frequency has been entered correctly, using Menu "I/O Checking" on the keypad.</p> <p>➔ Increase the reference frequency.</p> <p>➔ Inspect the external frequency command potentiometers, signal converters, switches, and relay contacts. Replace any ones that are faulty.</p> <p>➔ Connect external circuit wirings of terminals [13], [12], [11], [C1] correctly.</p>
(4) A frequency command (e.g., multi-frequency or via communications) with higher priority than the one attempted was active and its reference frequency was too low.	<p>Based on the frequency setting block diagram (See Chapter 8 "BLOCK DIAGRAMS FOR CONTROL LOGIC"), check the inputted frequency command by function code data check and I/O checking from Menu using the keypad.</p> <p>➔ Correct any incorrect data of function codes (e.g. cancel the higher priority frequency command).</p>
(5) The acceleration time was too long or too short.	<p>Check the data of acceleration times (F07, E10, E12, E14, H54).</p> <p>➔ Change the acceleration time to match the load.</p>
(6) Overload.	<p>Measure the inverter output current.</p> <p>➔ Reduce the load.</p> <p>Check whether any mechanical brake is applied.</p> <p>➔ Release the mechanical brake.</p>
(7) Function code settings do not agree with the motor characteristics.	<p>When automatic torque boost and automatic energy-saving operations are performed, confirm that P02*, P03*, P06*, P07*, P08* agree with motor constants.</p> <p>➔ Perform auto-tuning of the inverter for every motor to be used.</p>
(8) The output frequency does not increase due to the current limiter operation.	<p>Make sure that F43 (Current limiter (Mode selection)) is set to "2" and check the data of F44 (Current limiter (Level)).</p> <p>➔ Change the F44 data correctly. Or, set the F43 data to "0" (Disable) if the current limiter operation is not needed.</p> <p>Decrease the value of torque boost (F09*), then run the motor again and check if the speed increases.</p> <p>➔ If no stall occurs, decrease the F09* data.</p> <p>Check the data of function codes (F04*, F05*, H50, H51, H52, H53, H65, and H66) to ensure that the V/f pattern setting is right.</p> <p>➔ Match the V/f pattern setting with the motor ratings.</p>

6.5 When Codes Other Than Alarm Codes and Light Alarm Indication (\underline{L} - \overline{FL}) are Displayed

(9) The output frequency does not increase due to the torque limiter operation.	<p>Check whether the data of torque control levels (F40, F41, E16, E17) are set to appropriate values. Also, check whether torque limit 2/1 switching signal [TL2/TL1] is correct.</p> <ul style="list-style-type: none"> ➔ Correct the data of F40, F41, E16 and E17 or reset them to the factory defaults. ➔ Set the TL2/TL1 correctly.
(10) Bias and gain incorrectly specified.	<p>Check the data of the function codes (F18, C50, C32, C34, C37, C39, C42, C44, C55-C72).</p> <ul style="list-style-type: none"> ➔ Readjust the bias and gain to appropriate values.
(11) External wirings of terminals [X1]-[X5] are not connected correctly. Or settings are not correct.	<p>Check that the reference frequency has been entered correctly, using Menu "I/O Checking" on the keypad.</p> <ul style="list-style-type: none"> ➔ Connect the external circuit wirings of terminals [X1]-[X5] correctly. ➔ Set up the data of E01-E05 correctly. ➔ Set up the data of C05-C19 correctly (Setting of multistep frequency).
(12) Speed set value is not changing. (Keypad operation)	<p>Check whether it changes by changing the speed command value of keypad.</p> <ul style="list-style-type: none"> ➔ Press \odot / \oslash keys to change the speed command value.

[3] The motor runs in the opposite direction to the command

Possible Causes	Check and Measures
(1) Wiring to the motor is incorrect.	<p>Check the wiring to the motor.</p> <ul style="list-style-type: none"> ➔ Connect terminals U, V, and W of the inverter to the U, V, and W terminals of the motor, respectively.
(2) Incorrect connection and settings for run commands and rotation direction commands (FWD and REV).	<p>Check the data of function codes (E98 and E99) and the connection.</p> <ul style="list-style-type: none"> ➔ Correct the data of the function codes and the connection.
(3) A run command (with fixed rotational direction) from the keypad is active, but the rotational direction setting is incorrect.	<p>Check the data of function code F02 (Operation method).</p> <ul style="list-style-type: none"> ➔ Change the data of function code F02 to "2: / Keypad operation (forward rotation)" or "3: / Keypad operation (Reverse rotation)".
(4) The rotation direction mode of the motor is opposite to that of the inverter.	<p>The rotation direction of IEC-compliant motors is opposite to that of non compliant motors.</p> <ul style="list-style-type: none"> ➔ Switch the FWD/REV signal setting.
(5) The function code data related to the speed command are incorrect.	<p>Check the function code data. See Chapter 8 "BLOCK DIAGRAMS FOR CONTROL LOGIC."</p> <ul style="list-style-type: none"> ➔ Set correct data.

[4] Speed fluctuation or current oscillation (e.g., hunting) occurs during running at constant speed

Possible Causes	Check and Measures
(1) Analog speed setting is fluctuating.	<p>Check the signals for the frequency command with Menu "I/O Checking" using the keypad. (See Chapter 3 "3.4.4 Checking I/O signal status.")</p> <p>→ Increase the filter constants (C33, C38, and C43) for the frequency command.</p>
(2) An external frequency command potentiometer is used for frequency setting.	<p>Check that there is no noise in the control signal wires from external sources.</p> <p>→ Separate the signal wires from the main power wires as far as possible.</p> <p>→ Use shielded or twisted wires for control signals.</p>
	<p>Check whether the external frequency command potentiometer is malfunctioning due to noise from the inverter.</p> <p>→ Connect a capacitor to the output terminal of the potentiometer or insert a ferrite core on the signal wire. See Chapter 2 "Fig. 2.2-9 Example of Noise Countermeasures".</p>
(3) Frequency switching or multi-frequency command was enabled.	<p>Check whether the relay signal for switching the frequency command is chattering.</p> <p>→ If the relay contact is defective, replace the relay.</p>
(4) The wiring length between the inverter and the motor is too long.	<p>Check whether auto-torque boost, auto-energy saving operation, or dynamic torque vector control is enabled.</p> <p>→ Perform auto-tuning of the inverter for every motor to be used.</p> <p>→ Disable the automatic control systems by setting F37* to "1" (Constant torque load) and F42* to "0" (V/f control), then check that the motor vibration stops.</p> <p>→ Make the output wires as short as possible.</p>
(5) The machinery is hunting due to vibration caused by low rigidity of the load. Or the current is irregularly oscillating due to special motor parameters.	<p>After disabling all the automatic control systems such as auto torque boost, auto energy saving operation, overload prevention control, current limiter, torque limiter, anti-regenerative control, auto search for idling motor speed, slip compensation, dynamic torque vector control, droop control, overload stop function, speed control, online tuning, notch filter, and observer, check that the motor vibration disappears.</p> <p>→ Disable the functions causing the vibration.</p> <p>→ Readjust the output current fluctuation damping gain (H80*).</p>
	<p>Check that the motor vibration is suppressed if you decrease the value of F26 (Motor sound (Carrier frequency)) or set F27 (Motor sound (Tone)) to "0."</p> <p>→ Decrease the carrier frequency (F26) or set the tone to "0" (F27 = 0).</p>

[5] Unpleasant noises are emitted from motor or noises fluctuate

Possible Causes	Check and Measures
(1) The specified carrier frequency is too low.	<p>Check the data of motor operation noise (Carrier frequency) (F26) and motor operation noise (Tone) (F27).</p> <ul style="list-style-type: none"> ➔ Increase the carrier frequency (F26). ➔ Change the setting of F27 to the appropriate value.
(2) Ambient temperature of inverter is high. (In the selection of carrier frequency automatic reduction function (H98))	<p>Measure the temperature inside the panel where the inverter is mounted.</p> <ul style="list-style-type: none"> ➔ If it is over 40°C, lower it by improving the ventilation. ➔ Lower the temperature of inverter by reducing the load. In the case of fans/pumps, lower the frequency limiter Upper limit (F15). <p>NB) The release of H98 causes alarms $\overline{OH1}$, $\overline{OH3}$, \overline{OLU} in some cases.</p>
(3) Resonance with the load.	<p>Check the machinery mounting accuracy or check whether there is resonance with the mounting base.</p> <ul style="list-style-type: none"> ➔ Sort out the resonance cause by running the motor independently. ➔ Avoid continuous running at the frequency range where the resonance occurs by setting the jump frequency (C01-C04)

[6] Motor is not accelerated or decelerated according to set-up acceleration or deceleration times

Possible Causes	Check and Measures
(1) The inverter runs the motor with S-curve or curvilinear pattern.	<p>Check the data of function code H07 (Curve acceleration/ deceleration).</p> <ul style="list-style-type: none"> ➔ Set linear acceleration/deceleration. (H07=0) ➔ Shorten the acceleration/deceleration times (F07, F08, E10 through E15).
(2) The current limiting operation prevented the output frequency from increasing (during acceleration).	<p>Make sure that F43 (Current limiter (Mode selection)) is set to 2, then check that the setting of F44 (Current limiter (Level)) is reasonable.</p> <ul style="list-style-type: none"> ➔ Readjust the setting of F44 to appropriate value, or disable the function of current limiter with F43. ➔ Increase the acceleration/deceleration times (F07, F08, E10 through E15).
(3) The anti-regenerative control is enabled (during deceleration).	<p>Check the data of function code H69 (Anti-regenerative control (Mode selection)).</p> <ul style="list-style-type: none"> ➔ Increase the deceleration time (F08, E11, E13, and E15).
(4) Overload.	<p>Measure the inverter output current.</p> <ul style="list-style-type: none"> ➔ Reduce the load. For fans or pumps, decrease the frequency limiter Upper limit (F15). In winter, the load tends to increase.
(5) Torque generated by the motor was insufficient.	<p>Check that the motor starts running if the value of the torque boost (F09*) is increased.</p> <ul style="list-style-type: none"> ➔ Increase the value of the torque boost (F09*).
(6) An external frequency command potentiometer is used for frequency setting.	<p>Check that there is no noise in the control signal wires from external sources.</p> <ul style="list-style-type: none"> ➔ Separate the signal wires from the main power wires as far as possible. ➔ Use shielded or twisted wires for control signals. ➔ Connect a capacitor to the output terminal of the potentiometer or insert a ferrite core on the signal wire. See Chapter 2 "2.2.6 [3] Description of terminal functions (control circuit terminal) [12], [C1]."

6.5 When Codes Other Than Alarm Codes and Light Alarm Indication (\underline{L} - \overline{FL}) are Displayed

Possible Causes	Check and Measures
(7) The output frequency is limited by the torque limiter.	<p>Check whether the data of torque limit levels (F40, F41, E16, E17) are set to appropriate values. Also, check whether torque limit 2/1 switching signal [TL2/TL1] is correct.</p> <ul style="list-style-type: none"> ➔ Correct the data of F40, F41, E16 and E17 or reset them to the factory defaults. ➔ Set the TL2/TL1 correctly. ➔ Increase the acceleration/deceleration times (F07, F08, E10 through E15).
(8) The specified acceleration or deceleration time was incorrect.	<p>Check the terminal commands RT1 and RT2 for acceleration/ deceleration times.</p> <ul style="list-style-type: none"> ➔ Correct the RT1 and RT2 settings.

[7] The motor does not restart even after the power recovers from a momentary power failure

Possible Causes	Check and Measures
(1) The data of function code F14 is either "0," "1," or "2."	<p>Check if an undervoltage trip (\underline{L} \overline{U}) occurs.</p> <ul style="list-style-type: none"> ➔ Change the data of function code F14 (Restart mode after momentary power failure (Mode selection)) to "3," "4," or "5."
(2) The run command remains OFF even after the power has been restored.	<p>Check the input signal with Menu "I/O Checking" using the keypad. See Chapter 3 "3.4.4 Checking I/O signal status."</p> <ul style="list-style-type: none"> ➔ Check the power recovery sequence with an external circuit. If necessary, consider the use of a relay that can keep the run command ON. <p>In a 3-wire operation, momentary power failure duration is long so that control circuit power source of inverter is shut off once. Therefore, "select 3-wire operation" signal [HLD] is switched OFF once.</p> <ul style="list-style-type: none"> ➔ Change the design or the setting so that a run command can be issued again within 2 seconds after the power has been restored.

[8] Motor generates heat abnormally

Possible Causes	Check and Measures
(1) Excessive torque boost specified.	<p>Check whether decreasing the torque boost (F09*) decreases the output current but does not stall the motor.</p> <ul style="list-style-type: none"> ➔ If no stall occurs, decrease the torque boost (F09*).
(2) Continuous running in extremely slow speed.	<p>Check the running speed of the inverter.</p> <ul style="list-style-type: none"> ➔ Change the speed setting or replace the motor with a motor exclusively designed for inverters.
(3) Overload.	<p>Measure the inverter output current.</p> <ul style="list-style-type: none"> ➔ Reduce the load. In the case of fans/pumps, lower the setting value of F15 (Frequency limiter (Upper limit)). In winter, the load tends to increase.

[9] The motor does not run as expected

Possible Causes	Check and Measures
(1) Incorrect setting of function code data.	<p>Check that function codes are correctly configured and no unnecessary configuration has been done.</p> <ul style="list-style-type: none"> ➔ Configure all the function codes correctly. <p>Make a note of function code data currently configured and then initialize all function code data using H03.</p> <ul style="list-style-type: none"> ➔ After the above process, reconfigure function codes one by one, checking the running status of the motor.

[10] Motor stalls during acceleration

Possible Causes	Check and Measures
(1) The acceleration time was too short.	Check the data of acceleration time (F07, E10, E12, E14, H57, H58). → Extend the acceleration time.
(2) Moment of inertia of load is large.	Measure the inverter output current. → Reduce the moment of inertia of the load. → Increase the inverter capacity.
(3) Voltage drop of wiring is large.	Check the terminal voltage of motor. → Increase the diameter or shorten the distance of wirings between the inverter and motor.
(4) Load torque of load is large.	Measure the inverter output current. → Reduce the load torque of load. → Increase the inverter capacity.
(5) Torque generated by the motor was insufficient.	Check whether the inverter can make the motor rotate when torque boost related functions (F09, H51) are increased. → Change the setting of F09, F37, H51. Increase F09, H51.

6.5.2 Problems with inverter settings



[1] Nothing appears on the LED monitor

Possible Causes	Check and Measures
(1) No power (neither main power nor auxiliary control power) is supplied to the inverter.	<p>Check the input voltage and interphase voltage unbalance.</p> <ul style="list-style-type: none"> ➔ Switch on the molded-case circuit breaker, the earth-leakage circuit breaker (with overcurrent protective function) or the magnetic contactor. ➔ Check for voltage drop, phase loss, poor connections, or poor contacts and fix them if necessary.
(2) The power for the control PCB did not reach a sufficiently high level.	<p>Check if the shorting bar has been removed between terminals P1 and P(+) or if there is a poor contact between the shorting bar and those terminals.</p> <ul style="list-style-type: none"> ➔ Mount a shorting bar or a DC reactor between terminals P1 and P(+). In case of poor contact, tighten the screws.
(3) The keypad was not properly connected to the inverter.	<p>Check whether the keypad is properly connected to the inverter.</p> <ul style="list-style-type: none"> ➔ Remove the keypad, put it back, and see whether the problem recurs. ➔ Replace the keypad with another one and check whether the problem recurs. <p>When running the inverter remotely, ensure that the extension cable is securely connected both to the keypad and to the inverter.</p> <ul style="list-style-type: none"> ➔ Disconnect the cable, reconnect it, and see whether the problem recurs. ➔ Replace the keypad with another one and check whether the problem recurs.

[2] The desired menu is not displayed

Possible Causes	Check and Measures
(1) The menu display mode is not selected appropriately.	<p>Check the data of function code E52 (Keypad (Menu display mode)).</p> <ul style="list-style-type: none"> ➔ Change the E52 data so that the desired menu appears.



[3] Display of under bars (_ _ _ _)

Phenomena Although  key, run forward command [FWD], or  key, run reverse command [REV], was pressed, the motor did not rotate and under bars were displayed.

Possible Causes	Check and Measures
(1) The voltage of the DC intermediate circuit was low.	Select <u>S_01</u> from Menu #5 "Maintenance Information" in the program mode of keypad to check the DC intermediate circuit voltage (3-phase 200V: 200VDC or less, 3-phase 400V: 400VDC or less). ➔ Connect the inverter to a power supply that meets its voltage supply range.
(2) The main power is not ON, while the auxiliary input power to the control circuit is supplied.	Check whether the main power is turned ON. ➔ Turn on the main power. Check if the shorting bar has been removed between terminals P1 and P(+) or if there is a poor contact between the shorting bar and those terminals. ➔ Mount a shorting bar or a DC reactor between terminals P1 and P(+). In case of poor contact, tighten the screws.
(3) AC power source is not connected due to the connection of DC power supply, but the detection of main power interruption is activated (H72=1).	Check the connection to the main power and check if the H72 data is set to "1" (factory default). ➔ Review the data of H72.
(4) Breaks in wiring to the main power input terminals.	Measure the input voltage. ➔ Repair or replace the main circuit power input wires or input devices (MCCB, MC, etc.).

[4] Display of center bars (- - - -)

Phenomena A center bar (- - - -) appeared on the LED monitor.





Possible Causes	Check and Measures
(1) When PID control had been disabled (J01 = 0), E43 (LED Monitor (Item selection)) is set to 10 or 12. PID control has been disabled (J01 = 0) when the LED monitor had been set to display the PID command or PID feedback amount by pressing the  key.	Make sure that when you wish to view other monitor items, E43 is not set to "10: PID command" or "12: PID feedback value." ➔ Set E43 to a value other than "10" or "12." Make sure that when you wish to view a PID command or a PID feedback value, J01 (PID control) is not set to "0: Disable." ➔ Set J01 to "1: Enable (Process control normal operation)," "2: Enable (Process control inverse operation)," or "3: Enable (Dancer control)."
(2) The keypad was poorly connected.	Prior check: Even when  key is pressed, the display is not switched. Check continuity of the extension cable used in remote operation. ➔ Replace the cable.

[5] [] Display of parenthesis

Phenomena [] was displayed during speed monitoring by keypad.

Possible Causes	Check and Measures
(1) The display data overflows the LED monitor.	Check whether the product of the output frequency and the display coefficient (E50) exceeds 99,999. ➔ Correct the E50 data.

[6] Data of function codes cannot be changed

Possible Causes	Check and Measures
(1) An attempt was made to change function code data that cannot be changed when the inverter is running.	Check if the inverter is running with Menu "Drive Monitoring" using the keypad and then confirm whether the data of the function codes can be changed when the motor is running by referring to the function code tables. ➔ Stop the motor then change the data of the function codes.
(2) The data of the function codes is protected.	Check the data of function code F00 (Data protection). ➔ Change the data of F00 from a data protection state (F00=1 or 3) to a data changeable state (F00=0 or 2).
(3) The WE-KP terminal command ("Enable data change with keypad") is not entered, though it has been assigned to a digital input terminal.	Check the data of the function codes (E01-E05, E98, E99), and check the input state by using "I/O Checking" from the Menu on the keypad. ➔ Input a WE-KP command through a digital input terminal.
(4) The  key was not pressed.	Check whether  key was pressed after changing the data of the function codes. ➔ Press  key after changing the data. Check that <i>SAFE</i> is displayed on the LED monitor.
(5) The data of the function codes F02, E01-E05, E98, E99 are not changeable.	Either one of the FWD and REV terminal commands is turned ON. ➔ Turn OFF both FWD and REV.
(6) The function code(s) to be changed does not appear.	If Menu #0 "Quick Setup" ($Q.FnL$) is selected, only the particular function codes appear. ➔ Call the menu of $!F_{..}$ to $!Y_{..}$ by pressing  key from the quick setup ($Q.FnL$) state on the Menu to display the intended function code and to change the value. (See Chapter 3 Section 3.4 Table 3.4-1 "Menus Available in Programming Mode" for the details.)

[7] Function code data are not changeable (change from link functions)

Possible Causes	Check and Measures
(1) An attempt was made to change function code data that cannot be changed when the inverter is running.	Check if the inverter is running with Menu "Drive Monitoring" using the keypad and then confirm whether the data of the function codes can be changed when the motor is running by referring to the function code tables. ➔ Stop the motor then change the data of the function codes.
(2) The setting of the function code y33 (Built-in CAN communication:Operation selection) is wrong.	Check whether the setting of the function code y33 (Built-in CAN communication:Operation selection) is correct. ➔ Set y33 correctly.
(3) The data of the function code F02 is not changeable.	Either one of the FWD and REV terminal commands is turned ON. ➔ Turn OFF both FWD and REV.

Chapter 7

MAINTENANCE AND INSPECTION

This chapter describes the maintenance and inspection items of the inverter.

Contents

7.1	Inspection Interval	7-1
7.2	Daily Inspection	7-2
7.3	Periodic Inspection	7-3
7.3.1	Periodic inspection 1--Before the inverter is powered ON or after it stops running	7-3
7.3.2	Periodic inspection 2--When the inverter is ON or it is running	7-4
7.4	List of Periodic Replacement Parts	7-5
7.4.1	Judgment on service life	7-6
[1]	Measuring the capacitance of DC link bus capacitor in comparison with initial one at shipment	7-7
[2]	Measuring the capacitance of the DC link bus capacitor under ordinary operating conditions	7-8
[3]	Early warning of lifetime alarm	7-8
7.5	Measurement of Electrical Amounts in Main Circuit	7-9
7.6	Insulation Test	7-10
7.7	Inquiries about Product and Guarantee	7-11
7.7.1	When making an inquiry	7-11
7.7.2	Product warranty	7-11
[1]	Free of charge warranty period and warranty range	7-11
[2]	Exclusion of liability for loss of opportunity, etc.	7-12
[3]	Repair period after production stop, spare parts supply period (holding period)	7-12
[4]	Transfer rights	7-12
[5]	Service contents	7-12
[6]	Applicable scope of service	7-12

Perform daily and periodic inspections to avoid trouble and keep reliable operation of the inverter for a long time. When performing inspections, follow the instructions given in this chapter.

⚠ WARNING ⚠

- Before proceeding to the maintenance/inspection jobs, turn OFF the power and wait at least five minutes for inverters FRN0115E2■-2□ / FRN0072E2■-4□ / FRN0011E2■-7□ or below, or at least ten minutes for inverters FRN0085E2■-4□ or above. Make sure that the LED monitor / charging lamp are turned OFF. Further, make sure, using a multimeter or a similar instrument, that the DC link bus voltage between the terminals P(+) and N(-) has dropped to the safe level (+25 VDC or below).

Electric shock may occur.

- Maintenance, inspection, and parts replacement should be made only by authorized persons.
- Take off the watch, rings and other metallic objects before starting work.
- Use insulated tools.
- Never modify the inverter.

Electric shock or injuries could occur.

7.1 Inspection Interval

Table 7.1-1 lists the inspection intervals and check items, as a guide.

Table 7.1-1 List of Inspections

Inspection type	Inspection interval	Check items
Daily inspection	Every day	See Section 7.2 .
Periodic inspection	Every year	See Section 7.3 .
Decennial inspection *1	Every 10 years *2	Replacement of cooling fans *3 Replacement of DC link bus capacitors and close checks

*1 The decennial inspection (except replacement of cooling fans) should be performed only by the persons who have finished the Fuji Electric training course. Contact the sales agent where you purchased the product or your nearest Fuji Electric representative.

*2 Every 7 years for ND-mode inverters.

*3 For the standard replacement interval of cooling fans, refer to “7.4 List of Periodic Replacement Parts.”

Note The replacement intervals are based on the inverter’s service life estimated at an ambient temperature of 40°C at 100% (HHD-mode inverters) or 80% (ND-/HD-/HND-mode inverters) of full load. In environments with an ambient temperature above 40°C or a large amount of dust or dirt, the replacement intervals may be shorter.

Standard replacement intervals mentioned above are only a guide for replacement, not a guaranteed service life. Refer to “7.4 List of Periodic Replacement Parts.”

7.2 Daily Inspection

Visually inspect the inverter for operation errors from the outside without removing the covers when the inverter is running or the power is ON.

Table 7.2-1 lists daily inspection items.

Table 7.2-1 Daily Inspection List

Check part	Check item	How to inspect	Evaluation criteria
Environment	1) Check the surrounding temperature, humidity, vibration and atmosphere (dust, gas, oil mist, or water drops). 2) Check that tools or other foreign materials or dangerous objects are not left around the equipment.	1) Check visually or measure using apparatus. 2) Visual inspection	1) The usage environment given in Chapter 1, Section 1.3.1 must be satisfied. 2) No foreign or dangerous objects are left.
External appearance and others	1) Check that the bolts securing the wires to the main circuit terminals and control circuit terminals are not loose <u>before turning the power ON</u> . 2) Check for traces of overheat, discoloration and other defects. 3) Check for abnormal noise, odor, or excessive vibration.	1) Retighten <u>before turning the power ON</u> . 2) Visual inspection 3) Auditory, visual, and olfactory inspection	1) No loose screws. If loose, retighten the screws. 2), 3) No abnormalities
Cooling fans	Check for abnormal noise or excessive vibration when the cooling fans are in operation.	Auditory and visual inspections	No abnormalities
Keypad	Check for alarm indication.	Visual inspection	If any alarm is displayed, refer to Chapter 6.
Performance	Check that the inverter provides the expected performance (as defined in the standard specifications).	Check the monitor items shown on the keypad.	No abnormalities in the output speed, current and voltage and other running data.

7.3 Periodic Inspection

7.3.1 Periodic inspection 1--Before the inverter is powered ON or after it stops running

Perform periodic inspections according to the items listed in Table 7.3-1. Before performing periodic inspection 1, shut down the power and then remove the front cover.

Even if the power has been shut down, it takes the time for the DC link bus capacitor to discharge. After the charging lamp is turned OFF, therefore, make sure that the DC link bus voltage has dropped to the safe level (+25 VDC or below) using a multimeter or a similar instrument.

Table 7.3-1 Periodic Inspection List 1

Check part	Check item	How to inspect	Evaluation criteria	
Structure such as frame and cover	Check for: 1) Loose bolts (at clamp sections). 2) Deformation and breakage 3) Discoloration caused by overheat 4) Contamination and accumulation of dust or dirt	1) Retighten. 2), 3), 4) Visual inspection	1), 2), 3), 4) No abnormalities (If any section is stained, clean it with a soft cloth.)	
Main circuit	Common	1) Check that bolts and screws are tight and not missing. 2) Check the devices and insulators for deformation, cracks, breakage and discoloration caused by overheat or deterioration. 3) Check for contamination or accumulation of dust or dirt.	1) Retighten. 2), 3) Visual inspection	1), 2), 3) No abnormalities (If any section is stained, clean it with a soft cloth.)
	Conductors and wires	1) Check conductors for discoloration and distortion caused by overheat. 2) Check the sheath of the wires for cracks and discoloration.	1), 2) Visual inspection	1), 2) No abnormalities
	Terminal blocks	Check that the terminal blocks are not damaged.	Visual inspection	No abnormalities
	DC link bus capacitor	1) Check for electrolyte leakage, discoloration, cracks and swelling of the casing. 2) Check that the safety valve does not protrude remarkably.	1), 2) Visual inspection	1), 2) No abnormalities
	Braking resistor	1) Check for abnormal odor or cracks in insulators caused by overheat. 2) Check for wire breakage.	1) Olfactory and visual inspection 2) Check the wires visually, or disconnect either one of the wires and measure the conductivity with a multimeter.	1) No abnormalities 2) Within $\pm 10\%$ of the resistance of the braking resistor
Control circuit	1) Check for loose screws and connectors. 2) Check for odor and discoloration. 3) Check for cracks, breakage, deformation and remarkable rust. 4) Check the capacitors for electrolyte leaks and deformation.	1) Retighten. 2) Olfactory and visual inspection 3), 4) Visual inspection * Judgment on service life using "Menu #5 Maintenance Information" in Chapter 3, Section 3.4.5.	1), 2), 3), 4) No abnormalities	
Cooling system	Cooling fan	1) Check for engagement or abnormal vibration. 2) Check for loose bolts. 3) Check for discoloration caused by overheat.	1) Turn by hand. (Be sure to turn the power OFF beforehand.) 2) Retighten. 3) Visual inspection * Judgment on service life using "Menu #5 Maintenance Information" in Chapter 3, Section 3.4.5.	1) Smooth rotation 2), 3) No abnormalities
	Ventilation path	Check the heat sink, intake and exhaust ports for clogging and foreign materials.	Visual inspection	No clogging or accumulation of dust, dirt or foreign materials. Clean it, if any, with a vacuum cleaner.

7.3.2 Periodic inspection 2--When the inverter is ON or it is running

Visually inspect the inverter for operation errors from the outside without removing the covers when the inverter is ON or it is running.

Perform periodic inspections according to the items listed in Table 7.3-2

Table 7.3-2 Periodic Inspection List 2

Check part	Check item	How to inspect	Evaluation criteria	
Input voltage	Check that the input voltages of the main and control circuits are correct.	Measure the input voltages using a multimeter or the like.	The standard specifications must be satisfied.	
Structure such as chassis and covers	Check for abnormal noise or excessive vibration when the inverter is running.	Visual and auditory inspections	No abnormalities	
Main circuit	Transformers and reactors	Check for abnormal roaring noise or odor when the inverter is running.	Auditory, visual, and olfactory inspections	No abnormalities
	Magnetic contactors and relays	Check for chatters when the inverter is running.	Auditory inspection	No abnormalities
	DC link bus capacitor	Measure the capacitance if necessary.	Judgment on service life using "Menu #5 Maintenance Information (S.L.H.E)" in Chapter 3, Section 3.4.5.	Capacitance \geq Initial value x 0.85
Cooling fans	Check for abnormal noise or excessive vibration when the inverter is running.	Visual and auditory inspections	No abnormalities	

Additional notes

- (1) The inspection interval (every year) of check items given in Table 7.3-1 and Table 7.3-2 is merely a guide. Make the interval shorter depending on the usage environment.
- (2) Store and organize the inspection results to utilize them as a guide for operation and maintenance of the equipment and service life estimation.
- (3) At the time of an inspection, check the cumulative run times on the keypad to utilize them as a guide for replacement of parts. Refer to "7.4.1 Judgment on service life".
- (4) The inverter has cooling fans inside to ventilate itself for discharging the heat generated by the power converter section. This will accumulate dust or dirt on the heat sink depending on the ambient environment. In a dusty environment, the heat sink requires cleaning in a shorter interval than that specified in periodic inspection. Neglecting cleaning of the heat sink can rise its temperature, activating protective circuits to lead to an abrupt shutdown or causing the temperature rise of the surrounding electronic devices to adversely affect their service life.

7.4 List of Periodic Replacement Parts

Each part of the inverter has its own service life that will vary according to the environmental and operating conditions. It is recommended that the following parts be replaced at the specified intervals.

When the replacement is necessary, consult your Fuji Electric representative.

Table 7.4-1 Replacement Parts

Part name	Standard replacement intervals (See Note below.)
DC link bus capacitor	10 years (7 years in the ND mode)
Electrolytic capacitors on printed circuit boards	10 years (7 years in the ND mode)
Cooling fans	10 years (7 years in the ND mode)
Fuses	10 years (7 years in the ND mode)

Note. These replacement intervals are based on the inverter's service life estimated at a surrounding temperature of 40°C at 100% (HHD-mode inverters) or 80% (ND-/HD-/HND-mode inverters) of full load. In environments with an ambient temperature above 40°C or a large amount of dust or dirt, the replacement intervals may be shorter. The condition for inverters of FRN0020E2■-2□/FRN0012E2■-4□/FRN0011E2■-7□ or below capacity models is a load ratio of 80% even for HHD-mode.

Notes for periodic replacement of parts

- (1) The replacement intervals listed above are a guide for almost preventing parts from failure if those parts are replaced with new ones at the intervals. They do not guarantee the completely fault-free operation.
- (2) Table 7.4-1 does not apply to unused spare parts being kept in storage.
It applies only when they are stored under the temporary and long-term storage conditions given in Chapter 1 "1.3.2 Storage environment" and energized approximately once a year.
- (3) Cooling fans can be replaced by users. As for other parts, only the persons who have finished the Fuji Electric training course can replace them. For the purchase of spare cooling fans and the request for replacement of other parts, contact the sales agent where you purchased the product or your nearest Fuji Electric representative.

7.4.1 Judgment on service life

The inverter has the life prediction function for some parts which measures the discharging time or counts the voltage applied time, etc. The function allows you to monitor the current lifetime state on the LED monitor and judge whether those parts are approaching the end of their service life.

The life prediction function can also issue early warning signals if the life time alarm command **LIFE** is assigned to any of the digital output terminals. Refer to Chapter 3 “3.4.5 Reading maintenance information “Maintenance Information: *S.L.H.E*””.

Table 7.4-2 lists the parts whose service life can be predicted and details the life prediction function. The predicted values should be used only as a guide since the actual service life is influenced by the ambient temperature and other usage environments.

Table 7.4-2 Life Prediction

Object of life prediction	Prediction function	End-of-life criteria	Prediction timing	“5: MAINTENANCE” on the LED monitor
DC link bus capacitor	<u>Measurement of discharging time</u> Measures the discharging time of the DC link bus capacitor when the main power is shut down and calculates the capacitance.	85% or lower of the initial capacitance at shipment	At periodic inspection (H98: Bit 3 = 0)	<i>5_05</i> (Capacity)
		85% or lower of the reference capacitance under ordinary operating conditions at the user site	During ordinary operation (H98: Bit 3 = 1)	<i>5_05</i> (Capacity)
	<u>ON-time counting</u> Counts the time elapsed when the voltage is applied to the DC link bus capacitor, while correcting it according to the capacitance measured above.	Exceeding 87,600 hours (10 years)	During ordinary operation	<i>5_26</i> (Elapsed time) <i>5_27</i> (Time remaining before the end of life)
Electrolytic capacitors on printed circuit boards	Counts the time elapsed when the voltage is applied to the capacitors, while correcting it according to the surrounding temperature.	Exceeding 87,600 hours (10 years)	During ordinary operation	<i>5_06</i> (Cumulative run time)
Cooling fans	Counts the run time of the cooling fans.	Exceeding 87,600 hours (10 years)	During ordinary operation	<i>5_07</i> (Cumulative run time)

The service life of the DC link bus capacitor can be judged by the “Measurement of discharging time of the DC link bus capacitor” or “ON-time counting of DC link bus capacitor.”

Measurement of discharging time of the DC link bus capacitor

- The discharging time of the DC link bus capacitor depends largely on the inverter’s internal load conditions, e.g. options attached or ON/OFF status of digital I/O signals. If actual load conditions are so different from the ones at which the initial/reference capacitance is measured that the measurement result falls out of the accuracy level required, then the inverter does not measure.
When the inverter is connected with a converter or with another inverter via DC common connection, it does not perform any measurement.
- The capacitance measuring conditions at shipment are drastically restricted, e.g., all input terminals being OFF in order to stabilize the load and measure the capacitance accurately. Those conditions are, therefore, different from the actual operating conditions in almost all cases. If the actual operating conditions are the same as those at shipment, shutting down the inverter power automatically measures the discharging time; however, if they are different, no automatic measurement is performed. To perform it, put those conditions back to the factory default ones and shut down the inverter. Refer to 7.4.1 [1] Measuring the capacitance of DC link bus capacitor in comparison with initial one at shipment on page 7-7.
- To measure the capacitance of the DC link bus capacitor *under ordinary operating conditions* when the power is turned OFF, it is necessary to set up the load conditions for ordinary operation and measure the reference capacitance (initial setting) when the inverter is introduced. For the reference capacitance setup procedure, see [2] on page 7-8 Performing the setup procedure automatically detects and saves the measuring conditions of the DC link bus capacitor.

Setting bit 3 of H98 data at “0” restores the inverter to the measurement in comparison with the initial capacitance measured at shipment.

Note When the inverter uses an auxiliary control power input, the load conditions widely differ so that the discharging time cannot be accurately measured. In this case, measuring of the discharging time can be disabled with the function code H98 (Bit 4 = 0) for preventing unintended measuring.

ON-time counting of DC link bus capacitor

- In a machine system where the inverter main power is rarely shut down, the inverter does not measure the discharging time. For this case, the ON-time counting is provided. The ON-time counting result can be represented as “elapsed time” ($S_{-}Z5$) and “time remaining before the end of life” ($S_{-}Z7$) as shown in the “DC link bus capacitor” section in Table 7.4-2.

[1] Measuring the capacitance of DC link bus capacitor in comparison with initial one at shipment

The measuring procedure given below measures the capacitance of DC link bus capacitor in comparison with initial one at shipment when the power is turned OFF. The measuring result can be displayed on the keypad as a ratio (%) to the initial capacitance.

----- Capacitance measuring procedure -----

- 1) To ensure validity in the comparative measurement, put the condition of the inverter back to the state at factory shipment.
 - Remove the option card (if already in use) from the inverter.
 - In case another inverter is connected via the DC link bus to the P(+) and N(-) terminals of the main circuit, disconnect the wires. It is not required to disconnect the DC reactor (optional), if any.
 - Disconnect power wires for the auxiliary input to the control circuit (R0, T0).
 - Mount the keypad.
 - Turn OFF all the digital input signals fed to terminals [FWD], [REV], and [X1] through [X5] of the control circuit.
 - If an external speed command potentiometer is connected to terminal [13], disconnect it.
 - If an external apparatus is attached to terminal [PLC], disconnect it.
 - Ensure that transistor outputs [Y1] and [Y2] and Relay output terminals [30A/B/C] will not be turned ON.
 - Disable the RS-485 communications link and CANopen communications link.

Note If negative logic is specified for the transistor output and relay output signals, they are considered ON when the inverter is not running. Specify positive logic for them.
- 2) Turn ON the main circuit power.
- 3) Confirm that the DC cooling fan is rotating and the inverter is in stopped state. Disable the cooling fan ON/OFF control (H06 = 0).
- 4) Shut down the main circuit power.
- 5) The inverter automatically starts the measurement of the capacitance of the DC link bus capacitor.

Note If “. . . .” does not appear on the LED monitor, the measurement has not started. Check the conditions listed in 1).
- 6) After “. . . .” has disappeared from the LED monitor, turn ON the main circuit power again.
- 7) Select Menu #5 “Maintenance Information” in Programming mode and check the capacitance (%) of the DC link bus capacitor ($S_{-}05$).

[2] Measuring the capacitance of the DC link bus capacitor under ordinary operating conditions

The inverter automatically measures the capacitance of the DC link bus capacitor under ordinary operating conditions when the power is turned OFF. This measurement requires setting up the load conditions for ordinary operation and measuring the reference capacitance when the inverter is introduced to the practical operation, using the setup procedure given below

----- Reference capacitance setup procedure -----

- 1) Set bit 3 of function code H98 at "1" (User mode) to enable the user to specify the judgment criteria for the service life of the DC link bus capacitor.
- 2) Turn OFF all run commands.
- 3) Make the inverter ready to be turned OFF under ordinary operating conditions.
- 4) Set each of function codes H42 (Capacitance of DC link bus capacitor) and H47 (Initial capacitance of DC link bus capacitor) at "0000".
- 5) Turn OFF the inverter, and the following operations are automatically performed.

The inverter measures the discharging time of the DC link bus capacitor and saves the result in function code H47 (Initial capacitance of DC link bus capacitor).

The conditions under which the measurement has been conducted will be automatically collected and saved.

- 6) Turn ON the inverter again.

Confirm that H47 (Initial capacitance of DC link bus capacitor) holds right values. Switch to Menu #5 "Maintenance Information" in Programming mode and confirm that the main capacitor capacity is 100% (5.05 = 100%).

Note If the measurement has failed, "0001" is entered into each of H42 and H47. Remove the cause of the failure and conduct the measurement again.

Hereafter, each time the inverter is turned OFF, it automatically measures the discharging time of the DC link bus capacitor if the above conditions are met. Periodically check the capacitance (%) of the DC link bus capacitor (5.05) with Menu #5 "Maintenance Information" in Programming mode.

Note The condition given above produces a rather large measurement error. If this mode gives you a lifetime alarm, revert bit 3 of H98 (Main circuit capacitor life judgment selection) to the default setting (Bit 3 = 0) and conduct the measurement under the condition at the time of factory shipment.

[3] Early warning of lifetime alarm

For the components listed in Table 7.4-2, the inverter can issue an early warning of lifetime alarm LIFE at one of the transistor output terminals [Y1] and [Y2] and Relay output terminals [30A/B/C] as soon as any one of the levels specified in Table 7.4-2 has been exceeded.

The early warning signal is also turned ON when a lock condition on the internal air circulation DC fan (provided on FRN0203E2-4 or above) has been detected.

7.5 Measurement of Electrical Amounts in Main Circuit

Because the voltage and current of the power supply (input, primary circuit) of the main circuit of the inverter and those of the motor (output, secondary circuit) contain harmonic components, the readings may vary with the type of the meter. Use meters indicated in Table 7.5-1 when measuring main circuit.

The power factor cannot be measured by a commercially available power-factor meter that measures the phase difference between the voltage and current. To obtain the power factor, measure the power, voltage and current on each of the input and output sides and use the following formula.

■ Three-phase input

$$\text{Power factor} = \frac{\text{Electric power (W)}}{\sqrt{3} \times \text{Voltage (V)} \times \text{Current (A)}} \times 100 \%$$

Table 7.5-1 Meters for Measurement of Main Circuit

Item	Input (primary) side			Output (secondary) side			DC link bus voltage (P(+)-N(-))
Waveform	Voltage 		Current 	Voltage 		Current 	
Name of meter	Ammeter AR, AS, AT	Voltmeter VR, VS, VT	Wattmeter WR, WT	Ammeter AU, AV, AW	Voltmeter VU, VV, VW	Wattmeter WU, WW	DC voltmeter V
Type of meter	Moving iron type	Rectifier or moving iron type	Digital AC power meter	Digital AC power meter	Digital AC power meter	Digital AC power meter	Moving coil type
Symbol of meter			—	—	—	—	

Note It is not recommended that meters other than a digital AC power meter be used for measuring the output voltage or output current since they may cause larger measurement errors or, in the worst case, they may be damaged.

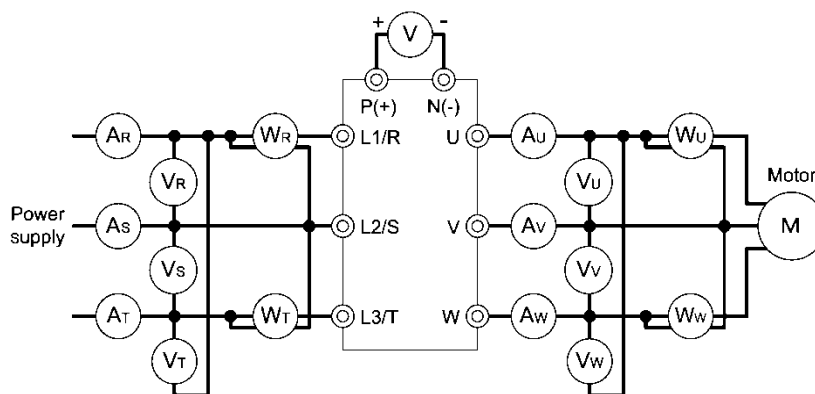

Figure 7.5-1 Connection of Meters

7.6 Insulation Test

Since the inverter has undergone an insulation test before shipment, avoid making a Megger test at the customer's site.

If a Megger test is unavoidable for the main circuit, observe the following instructions; otherwise, the inverter may be damaged.

A withstand voltage test may also damage the inverter if the test procedure is wrong. When the withstand voltage test is necessary, consult your Fuji Electric representative.

(1) Megger test of main circuit

- 1) Use a 500 VDC Megger and ensure that the main power has been shut off before measurement.
- 2) If the test voltage leaks to the control circuit due to the wiring, disconnect all the wiring from the control circuit.
- 3) Connect the main circuit terminals with a common line as shown in Figure 7.6-1.
- 4) The Megger test must be limited to across the common line of the main circuit and the ground (⊕).
- 5) Value of 5 MΩ or more displayed on the Megger indicates a correct state. (The value is measured on the inverter alone.)

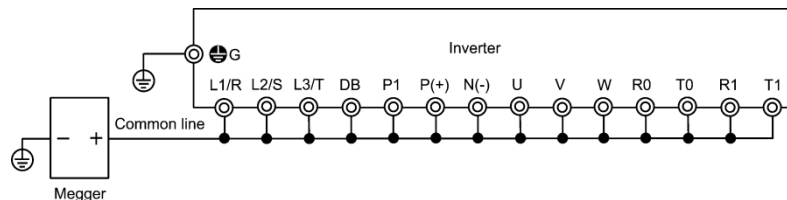

Figure 7.6-1 Main Circuit Terminal Connection for Megger Test

(2) Insulation test of control circuit

Do not make a Megger test or withstand voltage test for the control circuit. Use a high resistance range tester for the control circuit.

- 1) Disconnect all the external wiring from the control circuit terminals.
- 2) Perform a continuity test to the ground. One MΩ or a larger measurement indicates a correct state.

(3) Insulation test of external main circuit and sequence control circuit

Disconnect all the wiring connected to the inverter so that the test voltage is not applied to the inverter.

7.7 Inquiries about Product and Guarantee

7.7.1 When making an inquiry

Upon breakage of the product, uncertainties, failure or inquiries, inform your Fuji Electric representative of the following information.

- 1) Inverter type. Refer to Chapter 1 "1.1 Acceptance Inspection (Nameplates and Inverter Type)".
- 2) SER No. (serial number of equipment). Refer to Chapter 1 "1.1 Acceptance Inspection (Nameplates and Inverter Type)".
- 3) Function codes and their data that you changed. Refer to Chapter 3 "3.4.2 Checking changed function codes "Data Checking: *2rEP*".
- 4) ROM version. Refer to the maintenance item *S₄* in Chapter 3 "3.4.5 Reading maintenance information "Maintenance Information: *SLHE*".
- 5) Date of purchase
- 6) Inquiries (for example, point and extent of breakage, uncertainties, failure phenomena, and other circumstances)

7.7.2 Product warranty

To all our customers who purchase Fuji Electric products included in this documentation:

Please take the following items into consideration when placing your order.

When requesting an estimate and placing your orders for the products included in these materials, please be aware that any items such as specifications which are not specifically mentioned in the contract, catalog, specifications or other materials will be as mentioned below.

In addition, the products included in these materials are limited in the use they are put to and the place where they can be used, etc., and may require periodic inspection. Please confirm these points with your sales representative or directly with this company.

Furthermore, regarding purchased products and delivered products, we request that you take adequate consideration of the necessity of rapid receiving inspections and of product management and maintenance even before receiving your products.

[1] Free of charge warranty period and warranty range

(1) Free of charge warranty period

- 1) The product warranty period is "1 year from the date of purchase" or 24 months from the manufacturing date imprinted on the name place, whichever date is earlier.
- 2) However, in cases where the use environment, conditions of use, use frequency and times used, etc., have an effect on product life, this warranty period may not apply.
- 3) Furthermore, the warranty period for parts restored by Fuji Electric's Service Department is "6 months from the date that repairs are completed."

(2) Warranty range

- 1) In the event that breakdown occurs during the product's warranty period which is the responsibility of Fuji Electric, Fuji Electric will replace or repair the part of the product that has broken down free of charge at the place where the product was purchased or where it was delivered. However, if the following cases are applicable, the terms of this warranty may not apply.

- ① The breakdown was caused by inappropriate conditions, environment, handling or use methods, etc. which are not specified in the catalog, operation manual, specifications or other relevant documents.
- ② The breakdown was caused by the product other than the purchased or delivered Fuji's product.
- ③ The breakdown was caused by the product other than Fuji's product, such as the customer's equipment or software design, etc.
- ④ Concerning the Fuji's programmable products, the breakdown was caused by a program other than a program supplied by this company, or the results from using such a program.
- ⑤ The breakdown was caused by disassembly, modifications or repairs affected by a party other than Fuji Electric.
- ⑥ The breakdown was caused by improper maintenance or replacement using consumables, etc. specified in the operation manual or catalog, etc.

- ⑦ The breakdown was caused by a science or technical problem that was not foreseen when making practical application of the product at the time it was purchased or delivered.
- ⑧ The product was not used in the manner the product was originally intended to be used.
- ⑨ The breakdown was caused by a reason which is not this company's responsibility, such as lightning or other disaster.

- 2) Furthermore, the warranty specified herein shall be limited to the purchased or delivered product alone.
- 3) The upper limit for the warranty range shall be as specified in item (1) above and any damages (damage to or loss of machinery or equipment, or lost profits from the same, etc.) consequent to or resulting from breakdown of the purchased or delivered product shall be excluded from coverage by this warranty.

(3) Trouble diagnosis

As a rule, the customer is requested to carry out a preliminary trouble diagnosis. However, at the customer's request, this company or its service network can perform the trouble diagnosis on a chargeable basis. In this case, the customer is asked to assume the burden for charges levied in accordance with this company's fee schedule.

[2] Exclusion of liability for loss of opportunity, etc.

Regardless of whether a breakdown occurs during or after the free of charge warranty period, this company shall not be liable for any loss of opportunity, loss of profits, or damages arising from special circumstances, secondary damages, accident compensation to another company, or damages to products other than this company's products, whether foreseen or not by this company, which this company is not be responsible for causing.

[3] Repair period after production stop, spare parts supply period (holding period)

Concerning models (products) which have gone out of production, this company will perform repairs for a period of 7 years after production stop, counting from the month and year when the production stop occurs. In addition, we will continue to supply the spare parts required for repairs for a period of 7 years, counting from the month and year when the production stop occurs. However, if it is estimated that the life cycle of certain electronic and other parts is short and it will be difficult to procure or produce those parts, there may be cases where it is difficult to provide repairs or supply spare parts even within this 7-year period. For details, please confirm at our company's business office or our service office.

[4] Transfer rights

In the case of standard products which do not include settings or adjustments in an application program, the products shall be transported to and transferred to the customer and this company shall not be responsible for local adjustments or trial operation.

[5] Service contents

The cost of purchased and delivered products does not include the cost of dispatching engineers or service costs. Depending on the request, these can be discussed separately.

[6] Applicable scope of service

Above contents shall be assumed to apply to transactions and use of the country where you purchased the products.

Consult the local supplier or Fuji for details separately.

Chapter 8

BLOCK DIAGRAMS FOR CONTROL LOGIC

This chapter describes the main block diagrams of the control section.

Contents

8.1	Meanings of Symbols Used in the Control Block Diagrams	8-1
8.2	Frequency Setting Section	8-2
8.3	Operation Command Section	8-5
8.4	PID Control Section (for Processing)	8-6
8.5	PID Control Section (for Dancer)	8-7
8.6	Control Section	8-8
8.6.1	V/f control	8-8
[1]	Common	8-8
[2]	Without speed sensor	8-9
[3]	With speed sensor	8-10
8.6.2	Vector Control	8-11
[1]	Common	8-11
[2]	Torque command / Torque limit	8-12
[3]	Speed control / Torque control	8-13
[4]	Speed limit and Over speed protection processing	8-14
[5]	For IM	8-15
[6]	For PMSM	8-16
8.7	FM Output Section	8-18

8.1 Meanings of Symbols Used in the Control Block Diagrams

The high-performance and compact inverter FRENIC-Ace is provided with various functions that allow operations to meet the application requirements. Refer to Chapter 5 “FUNCTION CODES” for details of each function code.

Function codes are mutually related and priority order is given depending on the function codes and data thereof.







This chapter shows major internal control block diagrams. Understand the diagrams together with the explanation of each function code to correctly set up each function code.

Note that the internal control block diagrams show only the function codes mutually related. Refer to Chapter 5 “FUNCTION CODES” for function codes operated individually and each function code explanation.

8.1 Meanings of Symbols Used in the Control Block Diagrams

This section explains major codes, with examples, used in the block diagrams from the next item.

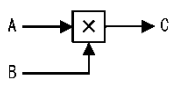
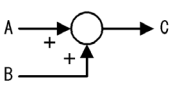
Table 8.1-1 Codes and Meanings

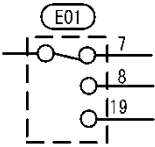
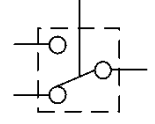
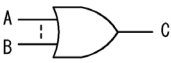
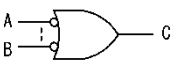
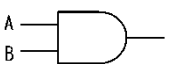
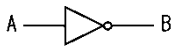
Symbol	Meaning
[FWD], [Y1], etc.	These symbols denote general-purpose input/output terminals of the inverter control circuit terminal blocks.
“FWD”, “REV”, etc.	These symbols denote control signals (input) or state signals (output) allocated to the control circuit terminals.
	This is low-pass filter. Time constant is changeable based on function code data.
	This symbol denotes control command used inside the inverter.
	This indicates upper limit limiter. This limits an upper limit value by function code setting or a constant.
	This indicates lower limit limiter. This limits a lower limit value by function code setting or a constant.
	This is 0 (zero) limiter. This prevents data from becoming minus.
	This denotes a set frequency given by a current or a voltage. This is a gain analog multiplier for an analog output signal etc., calculated by $C=A \times B$.
	This denotes an adder of two signals or amounts, calculated by $C=A+B$. This becomes a subtractor when B is a minus sign, calculated by $C=A-B$.
	This denotes a function code.
	This indicates a switch controlled by a function code. Figures of switch terminals indicate function code data.
	This indicates a switch controlled by an internal function control command. An example at left indicates a link operation selection command “LE” allocated to a digital input terminal.
	This denotes a logical sum (OR) circuit. In the case of the positive logic, when any one of inputs is ON, C=ON, and when all inputs are OFF, C=OFF.
	This denotes an NOR (NOR-OR) circuit. In the case of the positive logic, when any one of inputs is OFF, C=ON, and when all inputs are ON, C=OFF.
	This denotes a conjunction (AND) circuit. In the case of the positive logic, only when A=ON and B=ON, C=ON, and C=OFF under other conditions.
	This denotes a logical negation (NOT) circuit. In the case of the positive logic, when A=ON, B=OFF, and when A=OFF, B=ON.

8.2 Frequency Setting Section

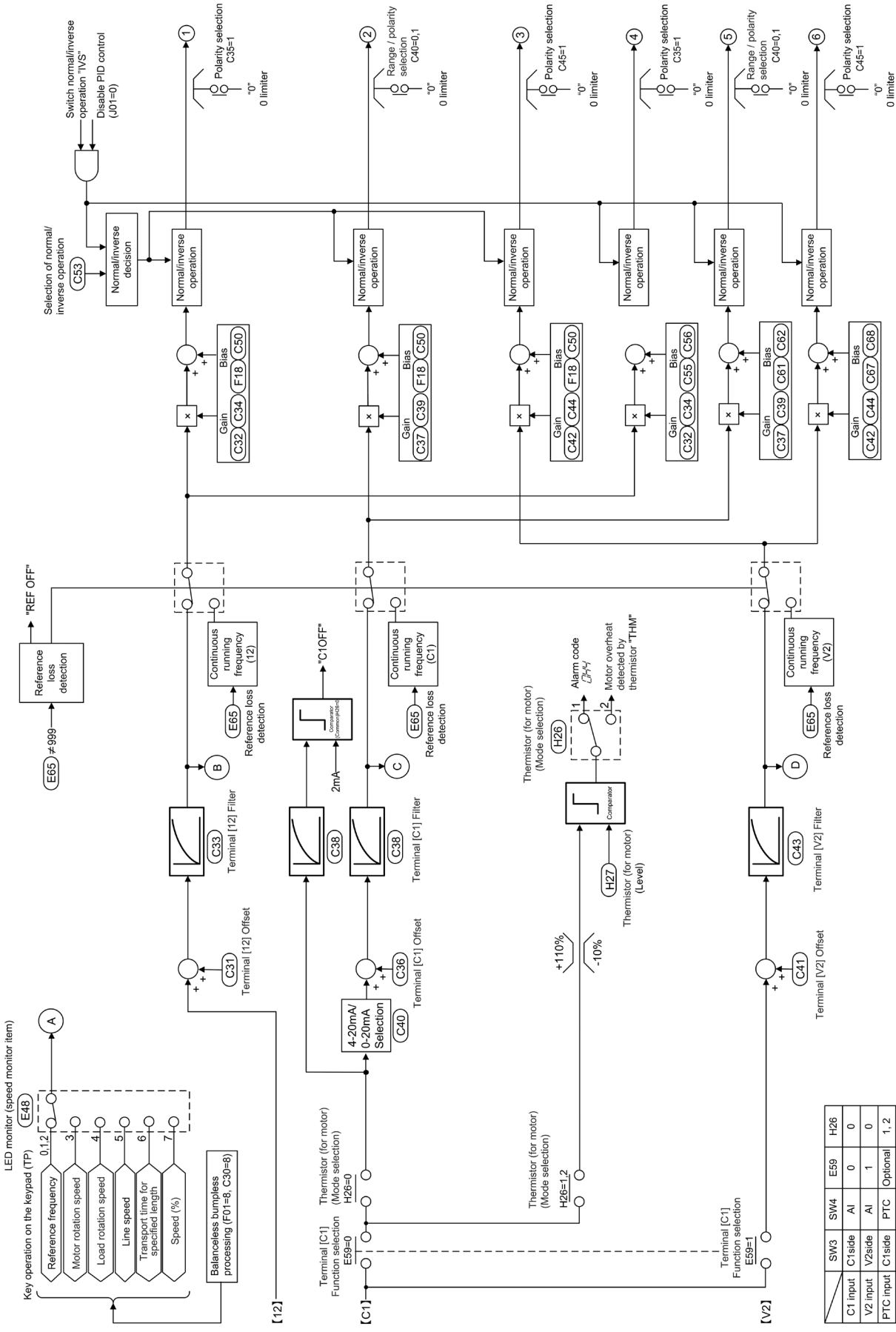

Figure 8.2-1 Frequency Setting Section Block Diagram

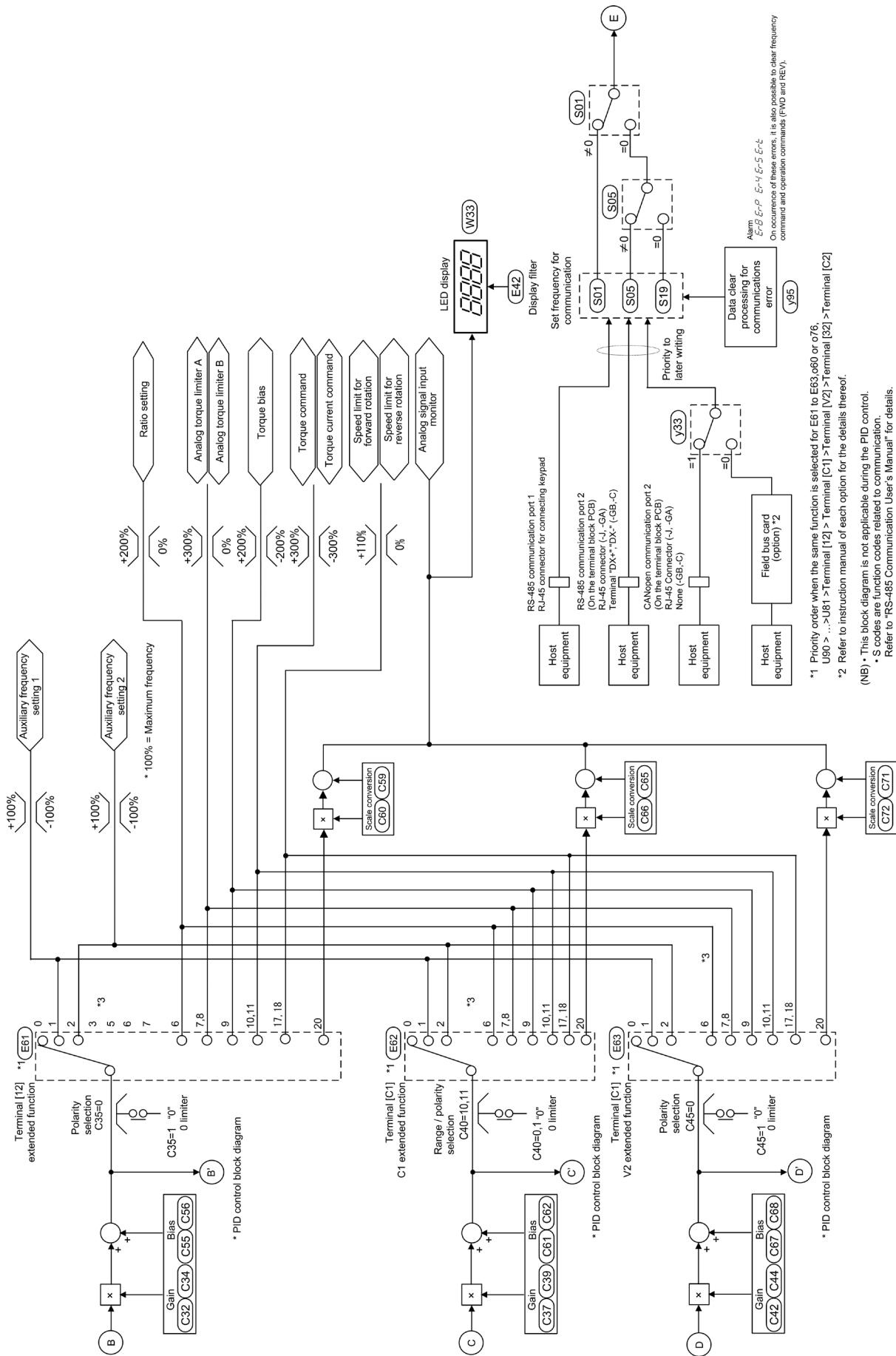

Figure 8.2-2 Frequency Setting Section Block Diagram

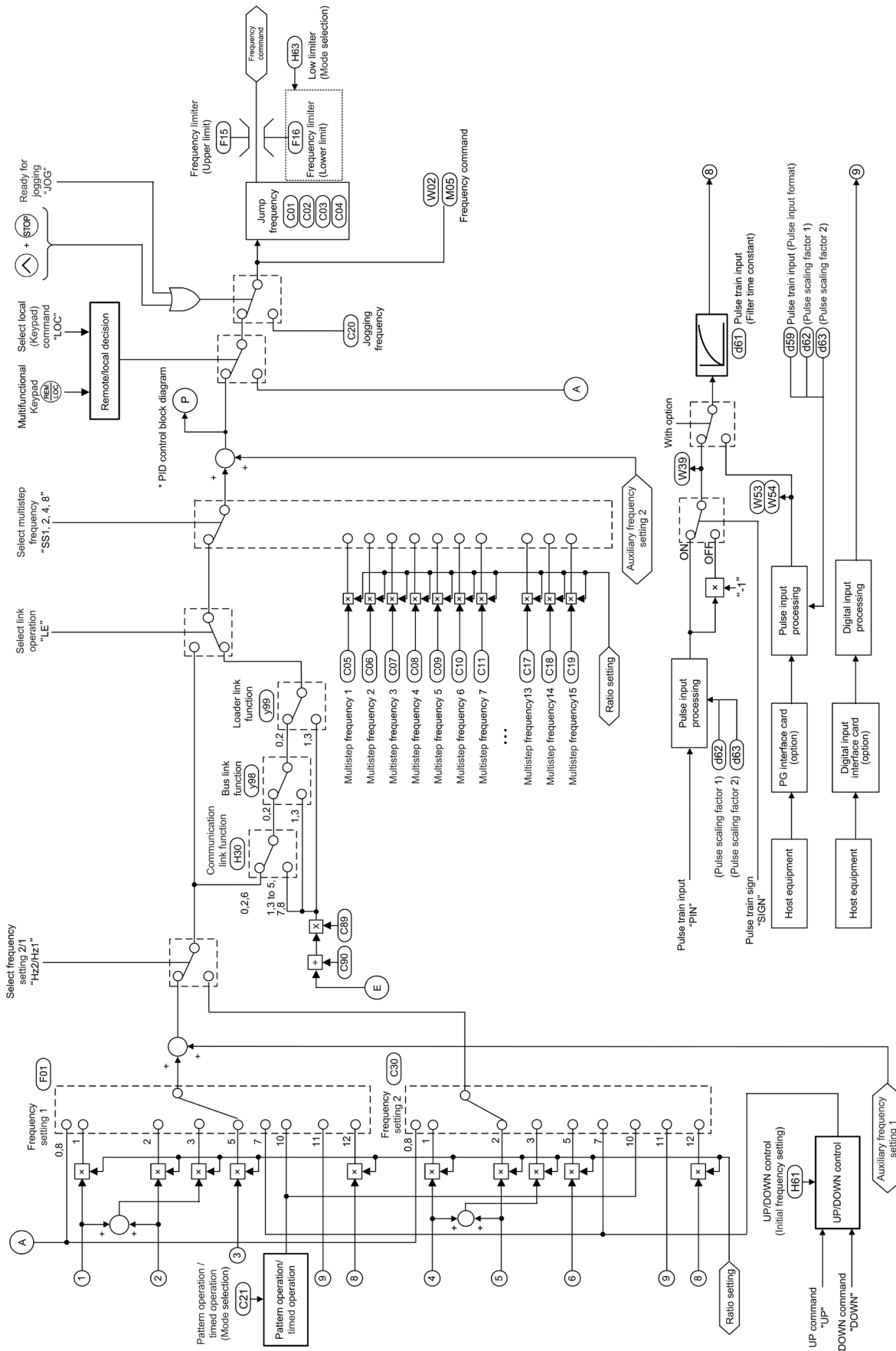

Figure 8.2-3 Frequency Setting Section Block Diagram

8.3 Operation Command Section

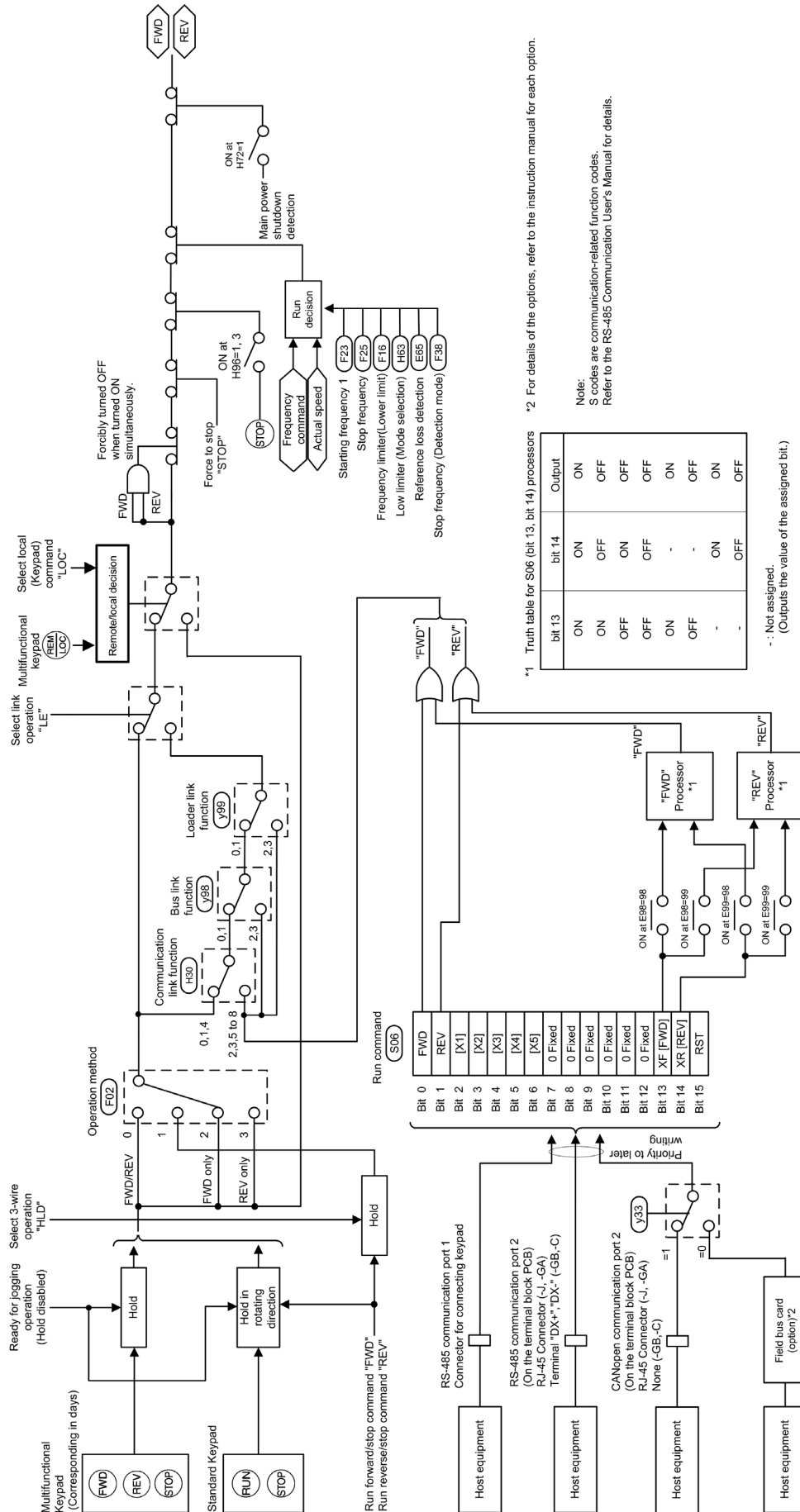
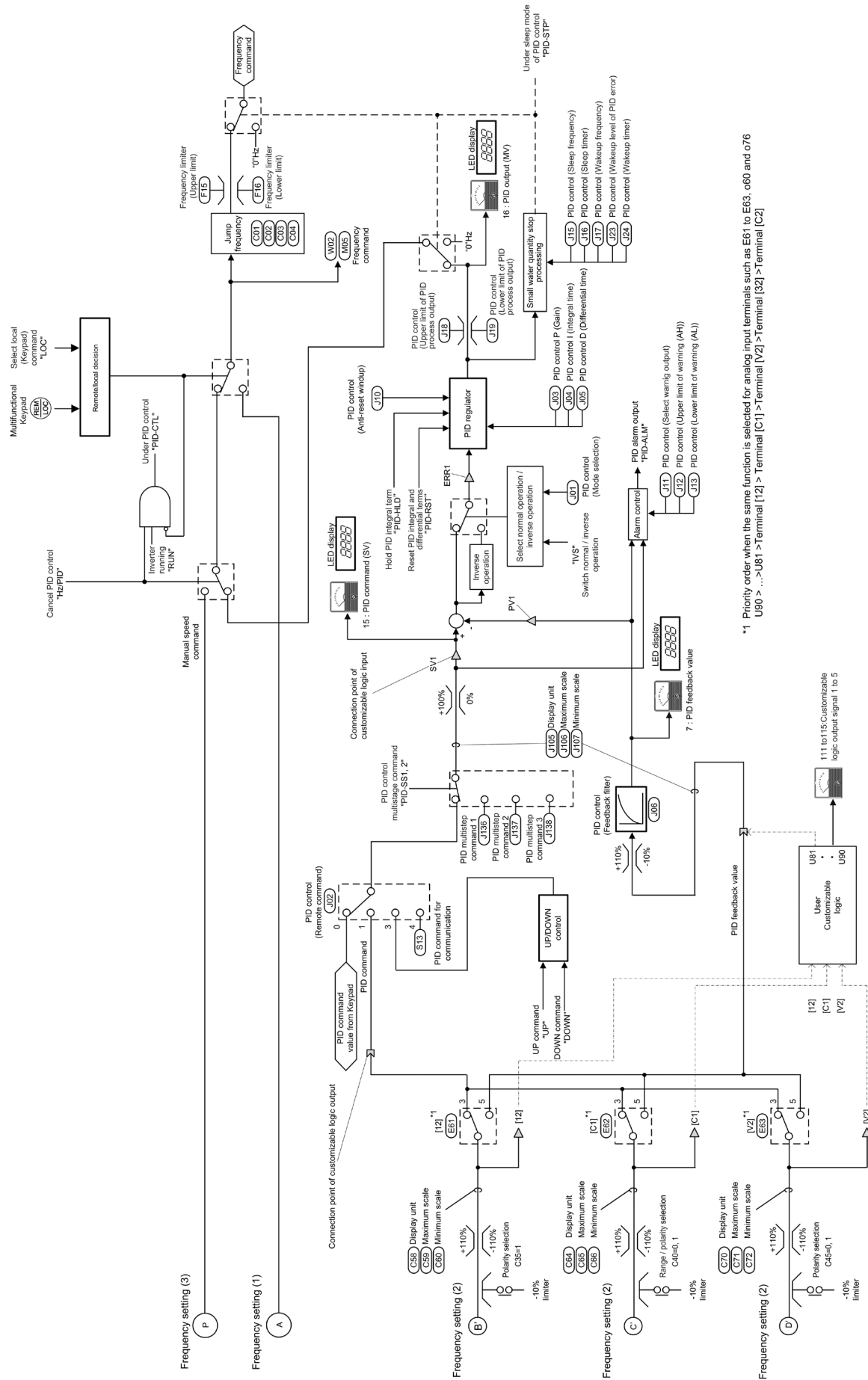

Figure 8.3-1 Operation Command Section Block Diagram

8.4 PID Control Section (for Processing)



*1 Priority order when the same function is selected for analog input terminals such as E61 to E63, o60 and o76
 U80 > ... > U81 > Terminal [12] > Terminal [C1] > Terminal [V2] > Terminal [32] > Terminal [C2]

Figure 8.4-1 PID Control Section (For Processing) Block Diagram

8.5 PID Control Section (for Dancer)

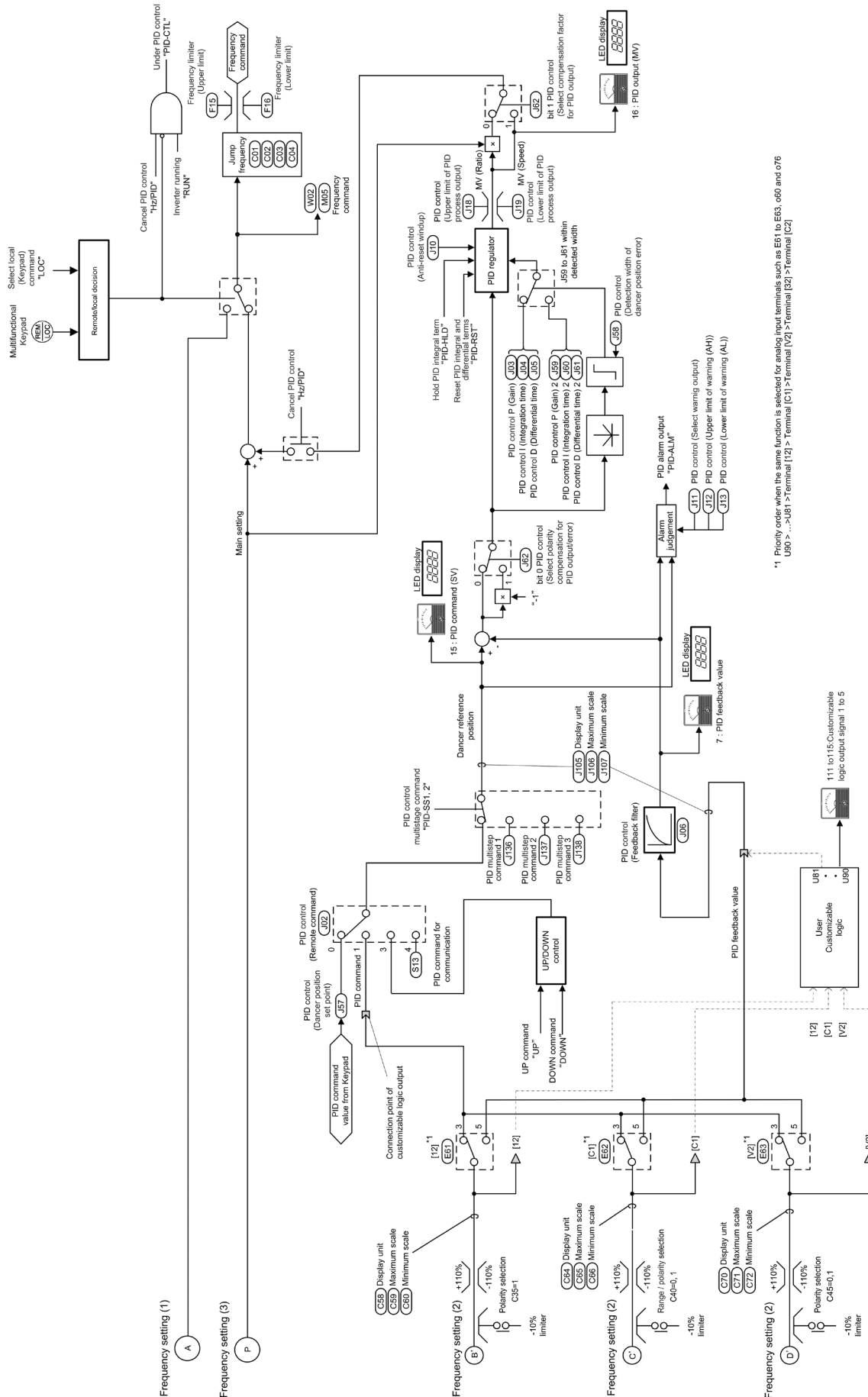

*1 Priority order when the same function is selected for analog input terminals such as E61 to E63, e60 and e76
 U90 > ...>U81 >Terminal [12] >Terminal [C1] >Terminal [V2] >Terminal [C2]

Figure 8.5-1 PID Control Section (For Dancer) Block Diagram

8.6 Control Section

8.6.1 V/f control

[1] Common

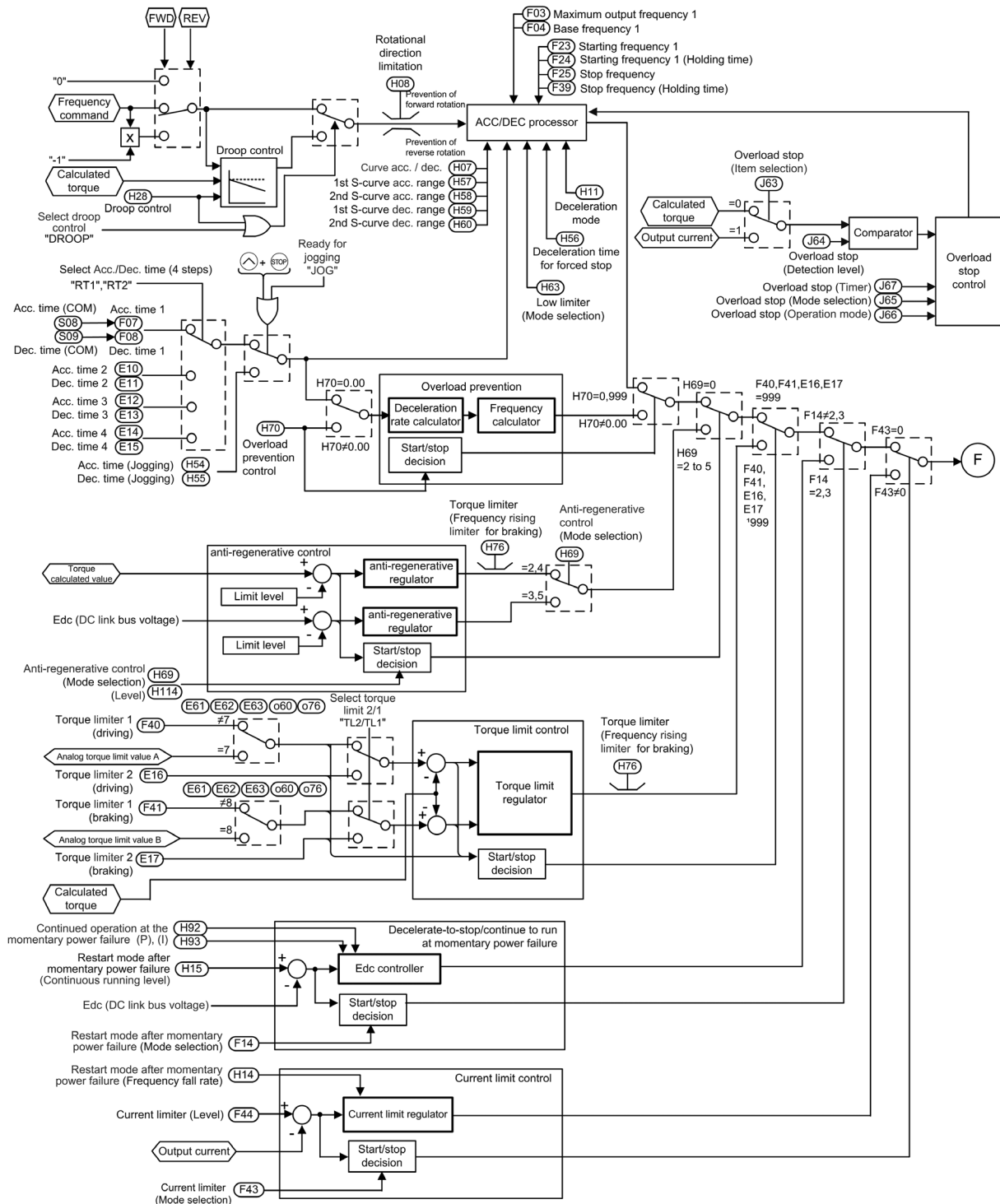

Figure 8.6-1 V/f control (Common) Section Block Diagram

[2] Without speed sensor

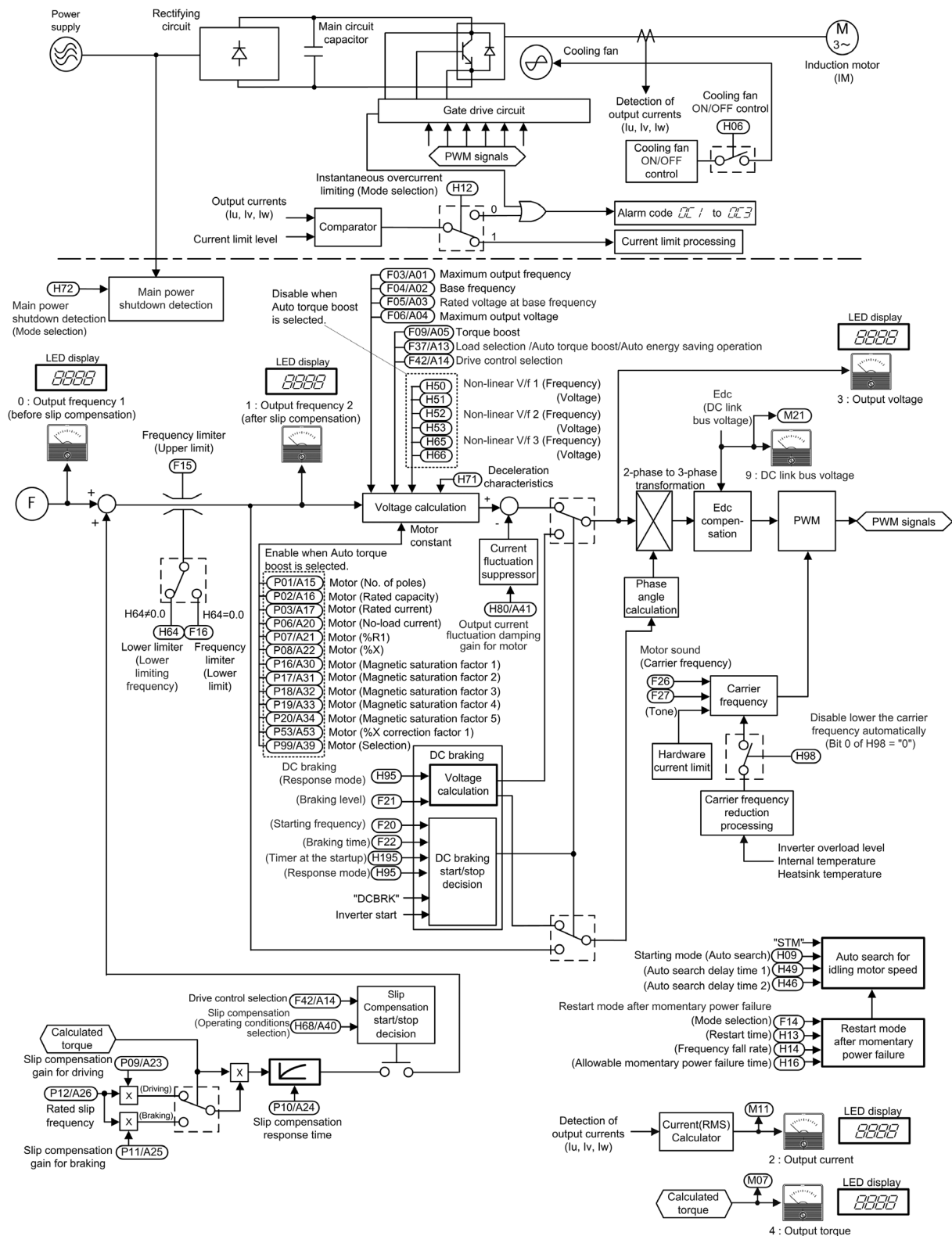

Figure 8.6-2 V/f Control (without speed sensor) Section Block Diagram

[3] With speed sensor

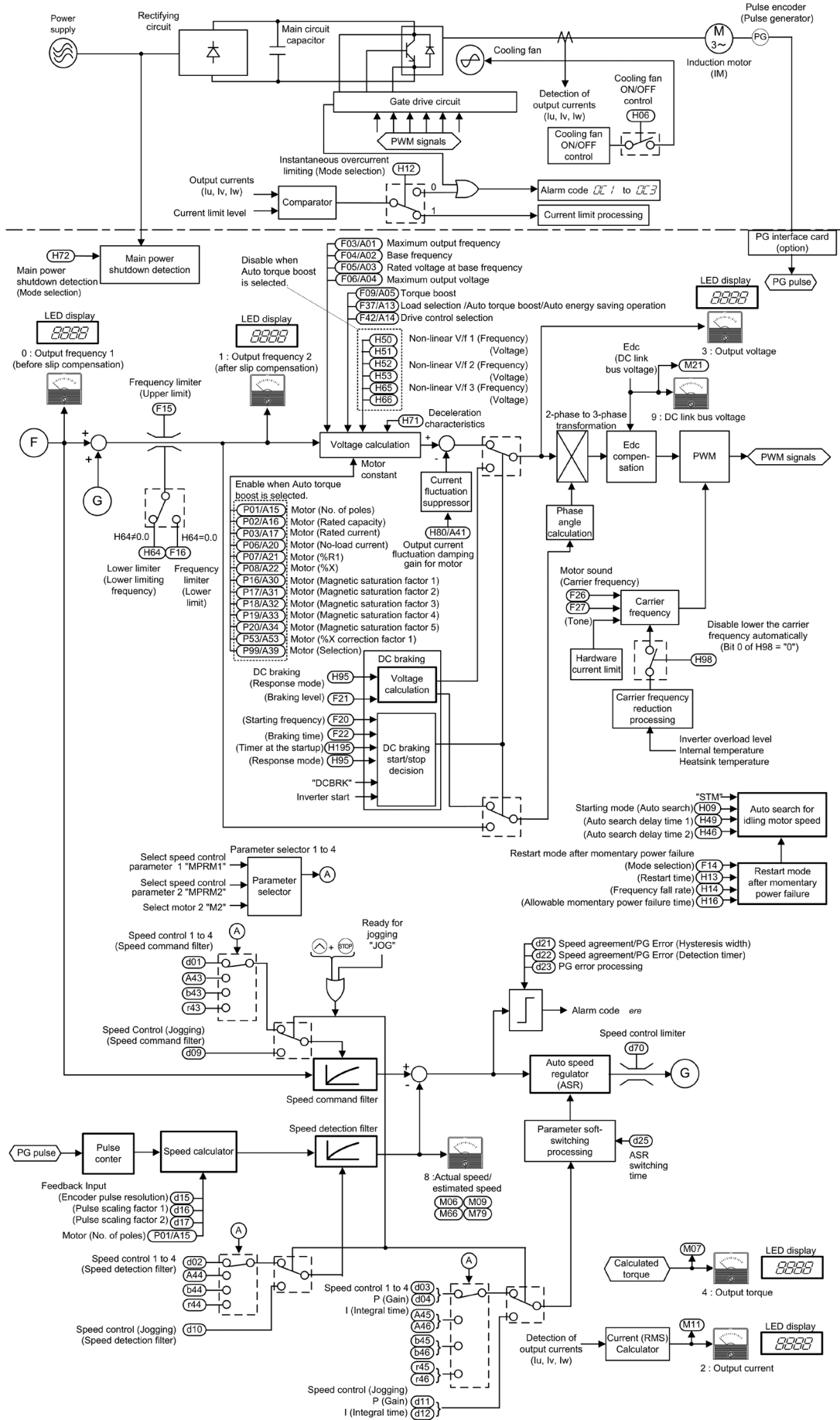

Figure 8.6-3 V/f Control (with speed sensor) Section Block Diagram

8.6.2 Vector Control

[1] Common

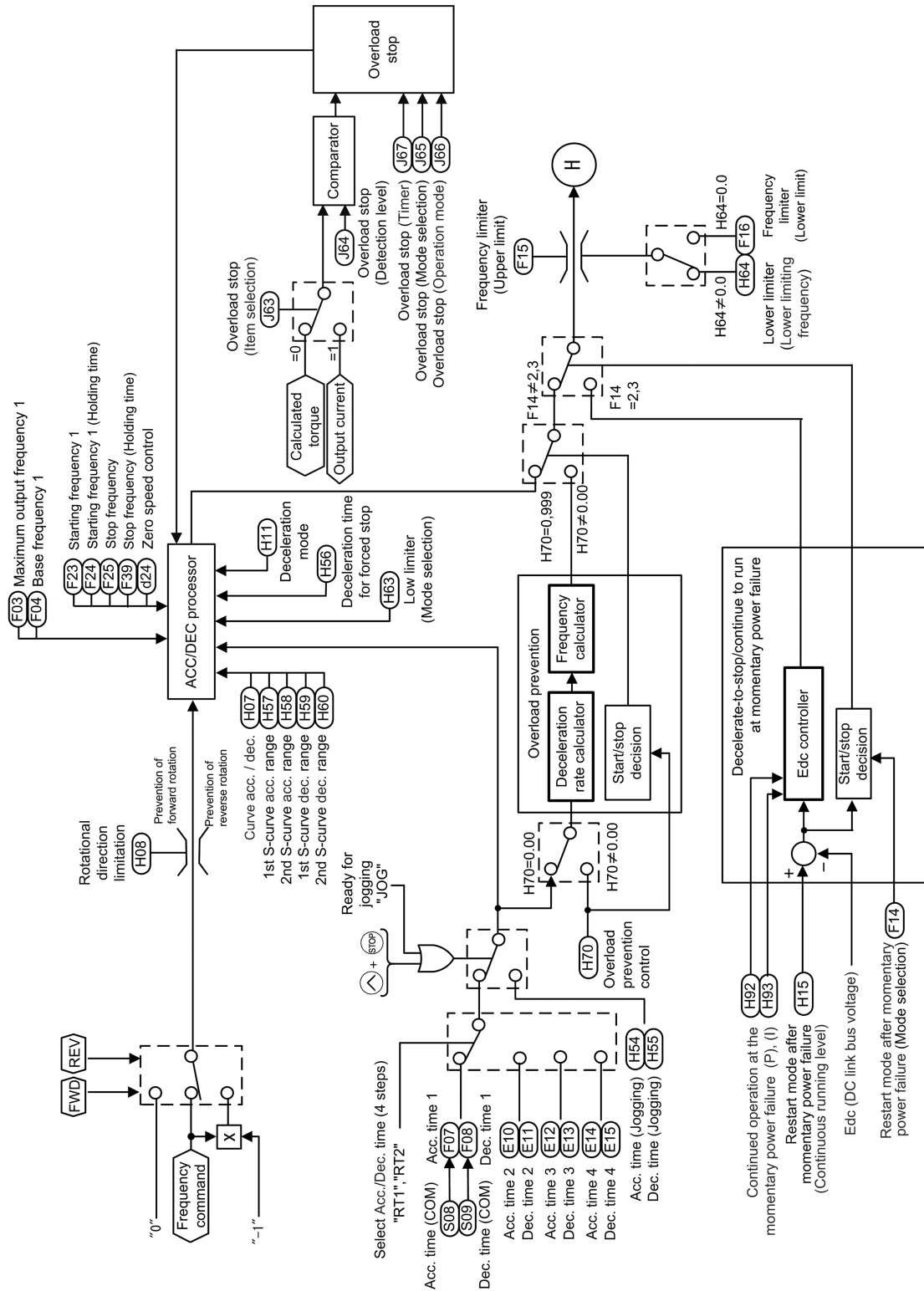

Figure 8.6-4 Vector Control (Common) Section Block Diagram

[2] Torque command / Torque limit

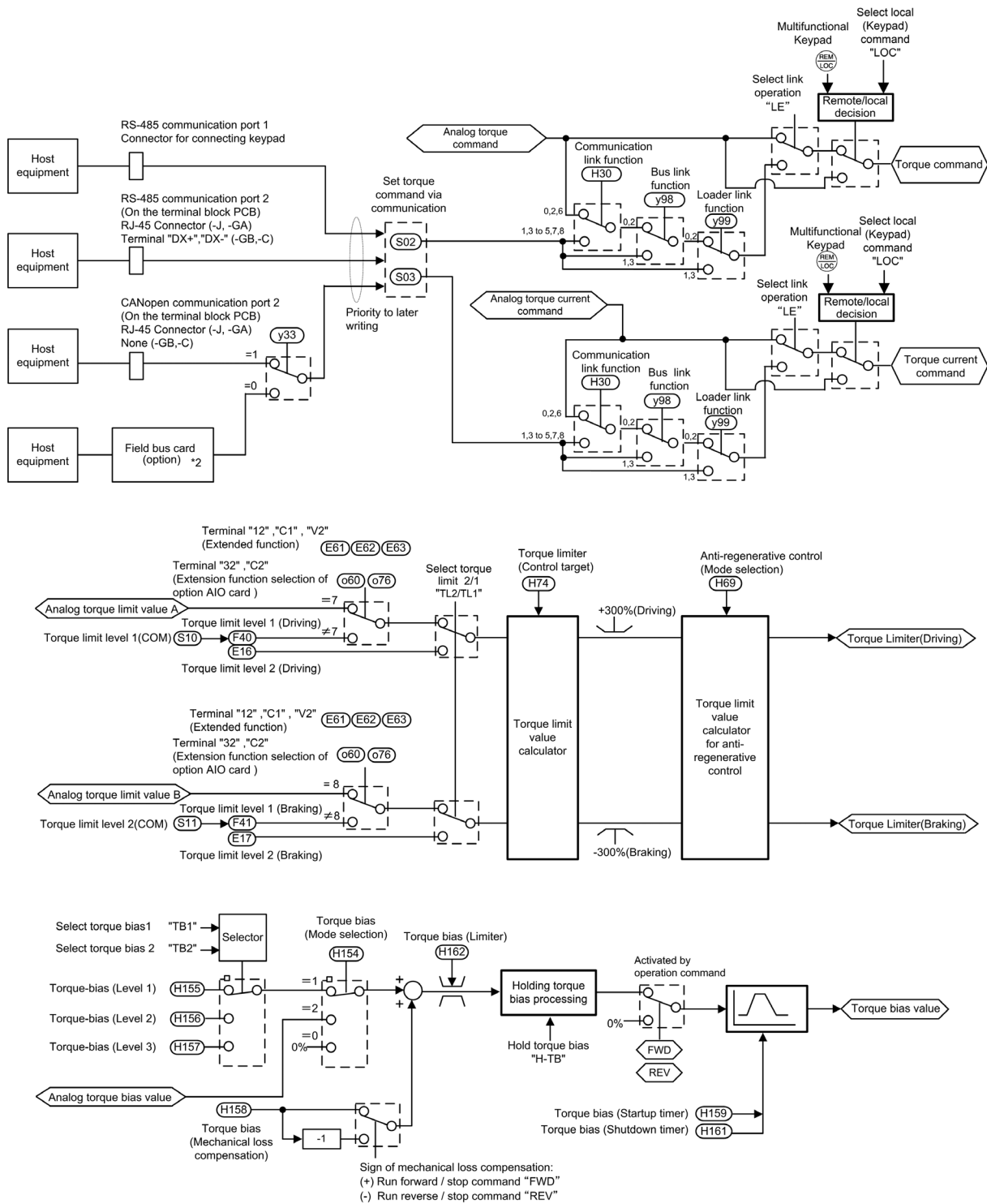

Figure 8.6-5 Vector Control (Torque command / Torque limit) Section Block Diagram

[3] Speed control / Torque control

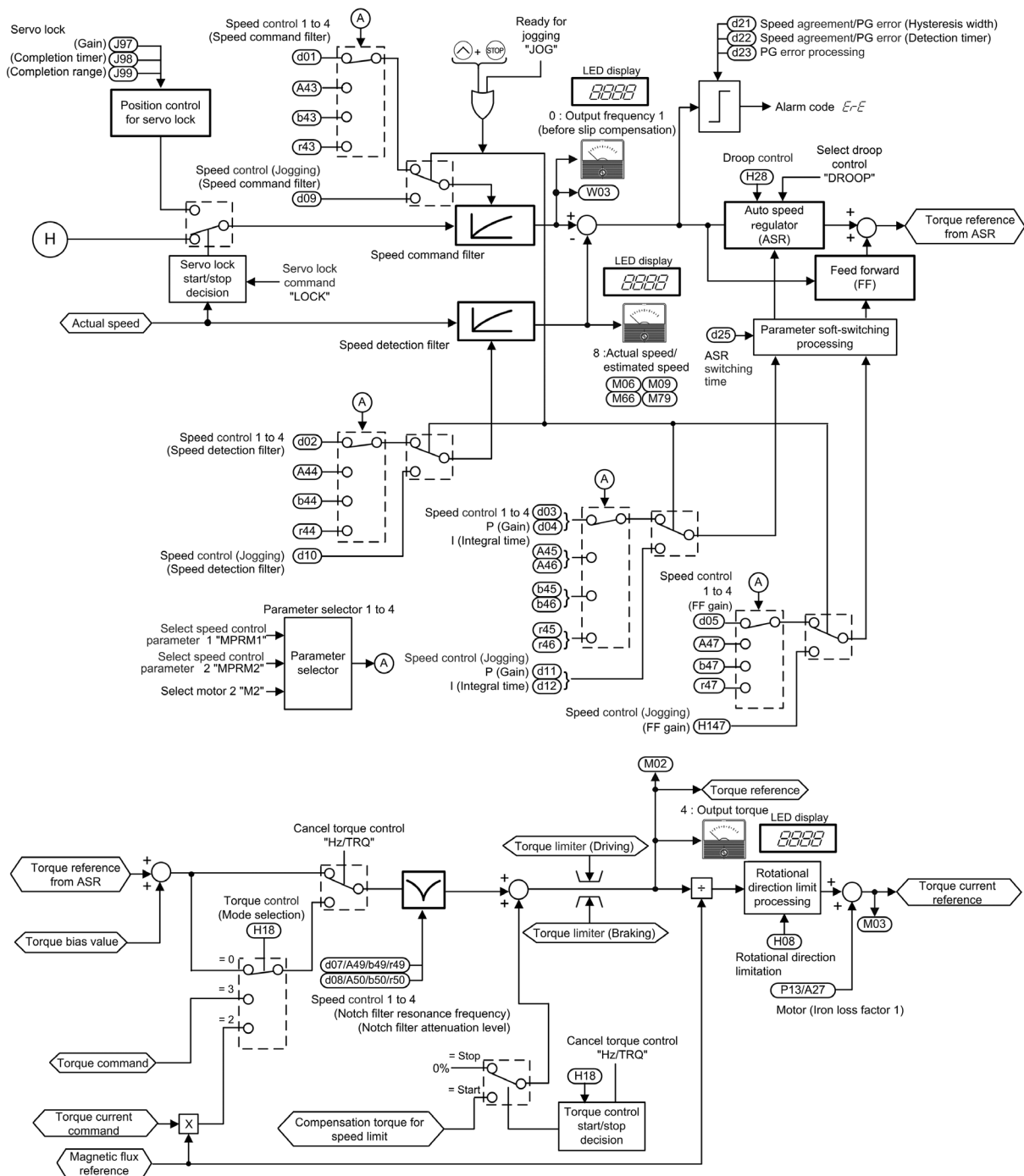

Figure 8.6-6 Vector Control (Speed control / Torque control) Section Block Diagram

[4] Speed limit and Over speed protection processing

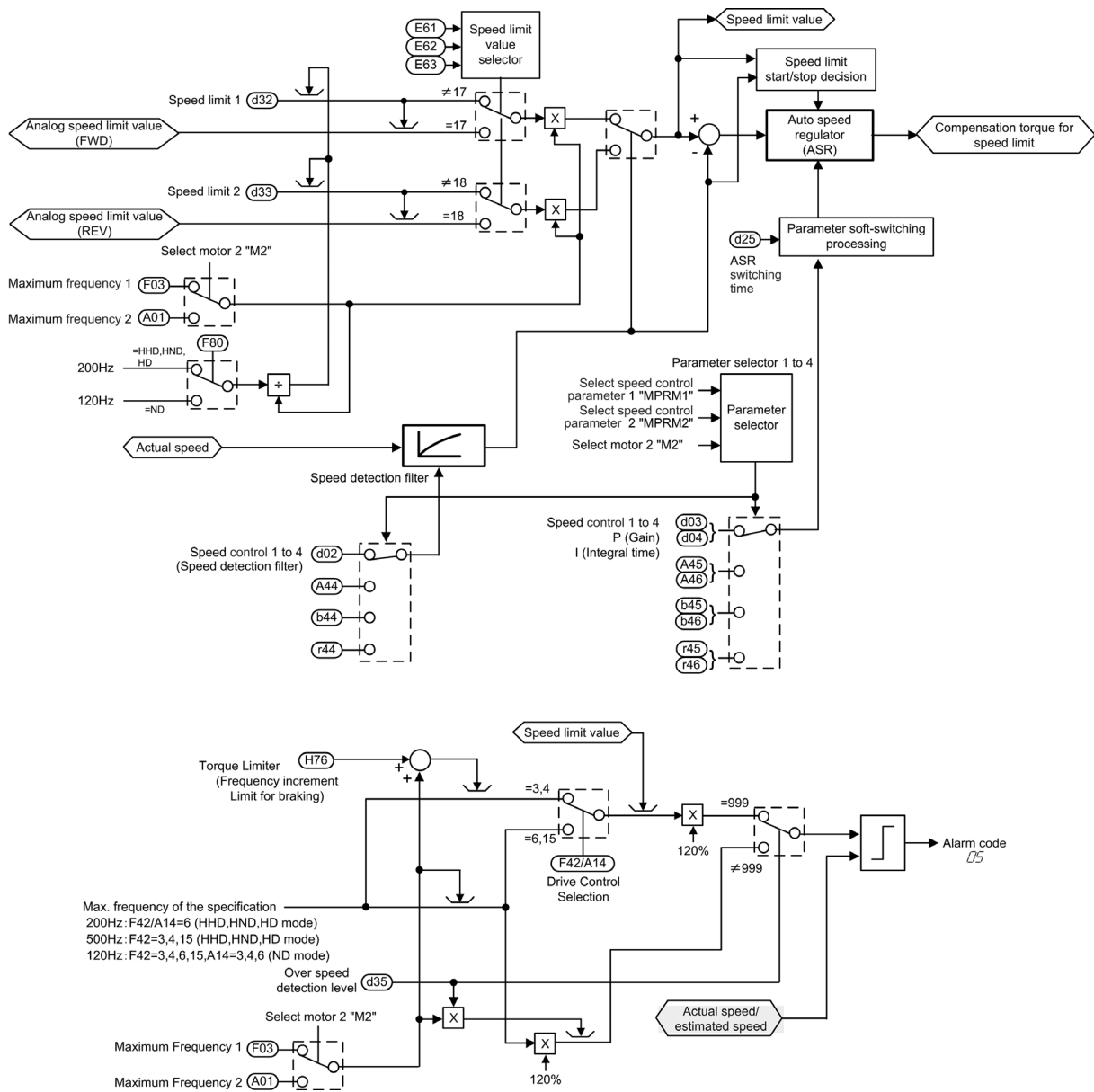

Figure 8.6-7 Vector Control (Speed limit (OS processing)) Section Block Diagram

[5] For IM

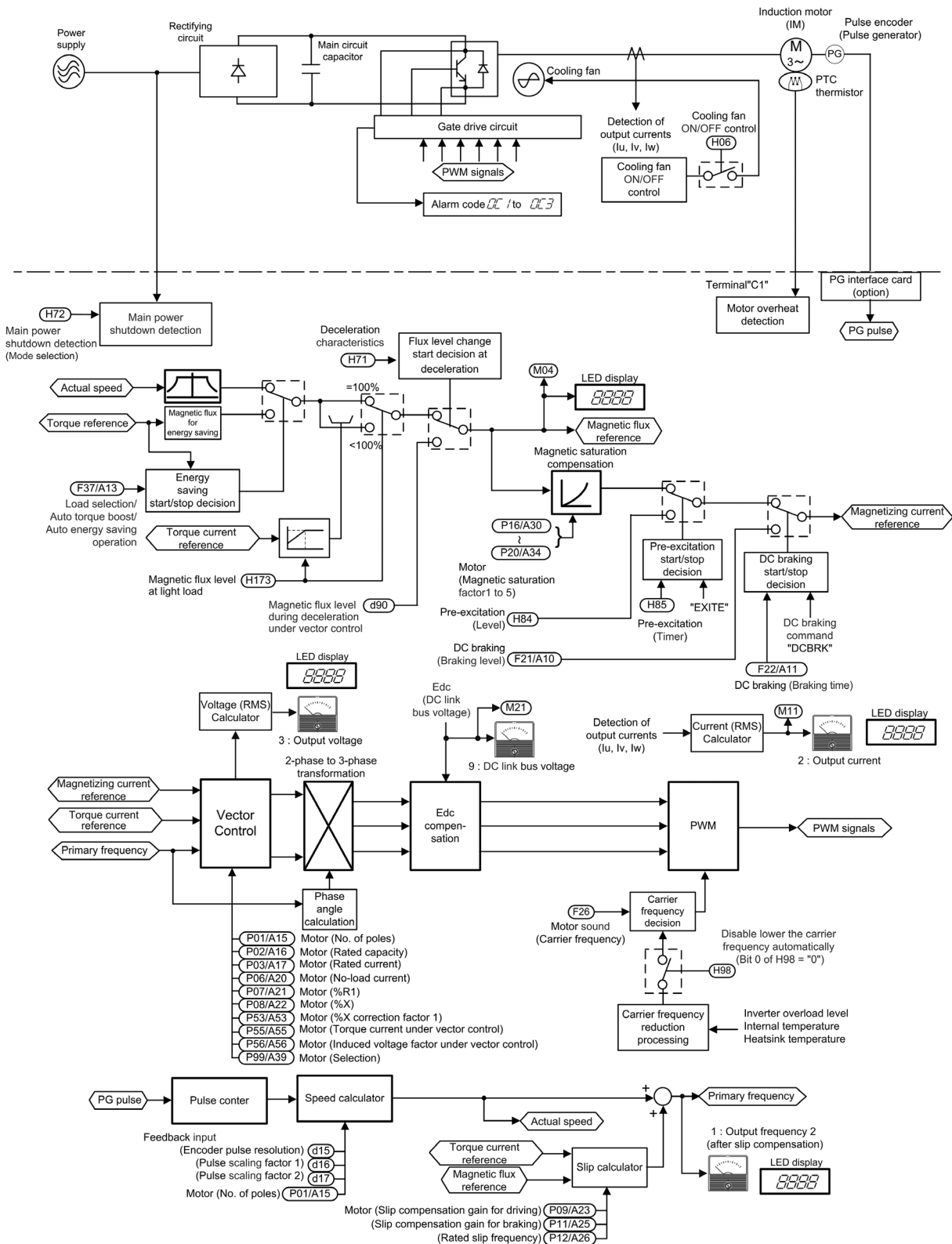

Figure 8.6-8 Vector Control (For IM) Section Block Diagram

[6] For PMSM

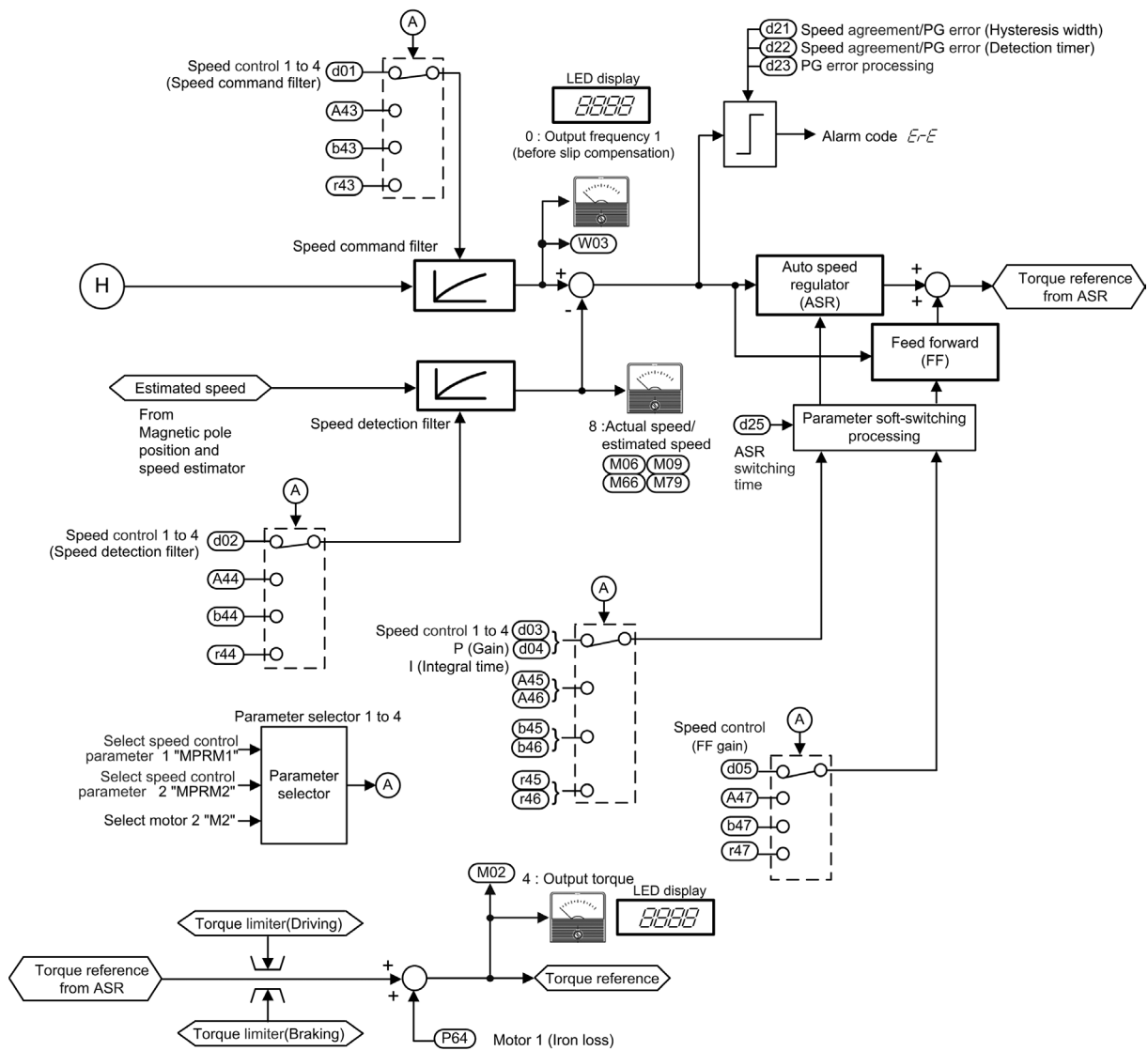

Figure 8.6-9 Vector Control (For PMSM) Section Block Diagram

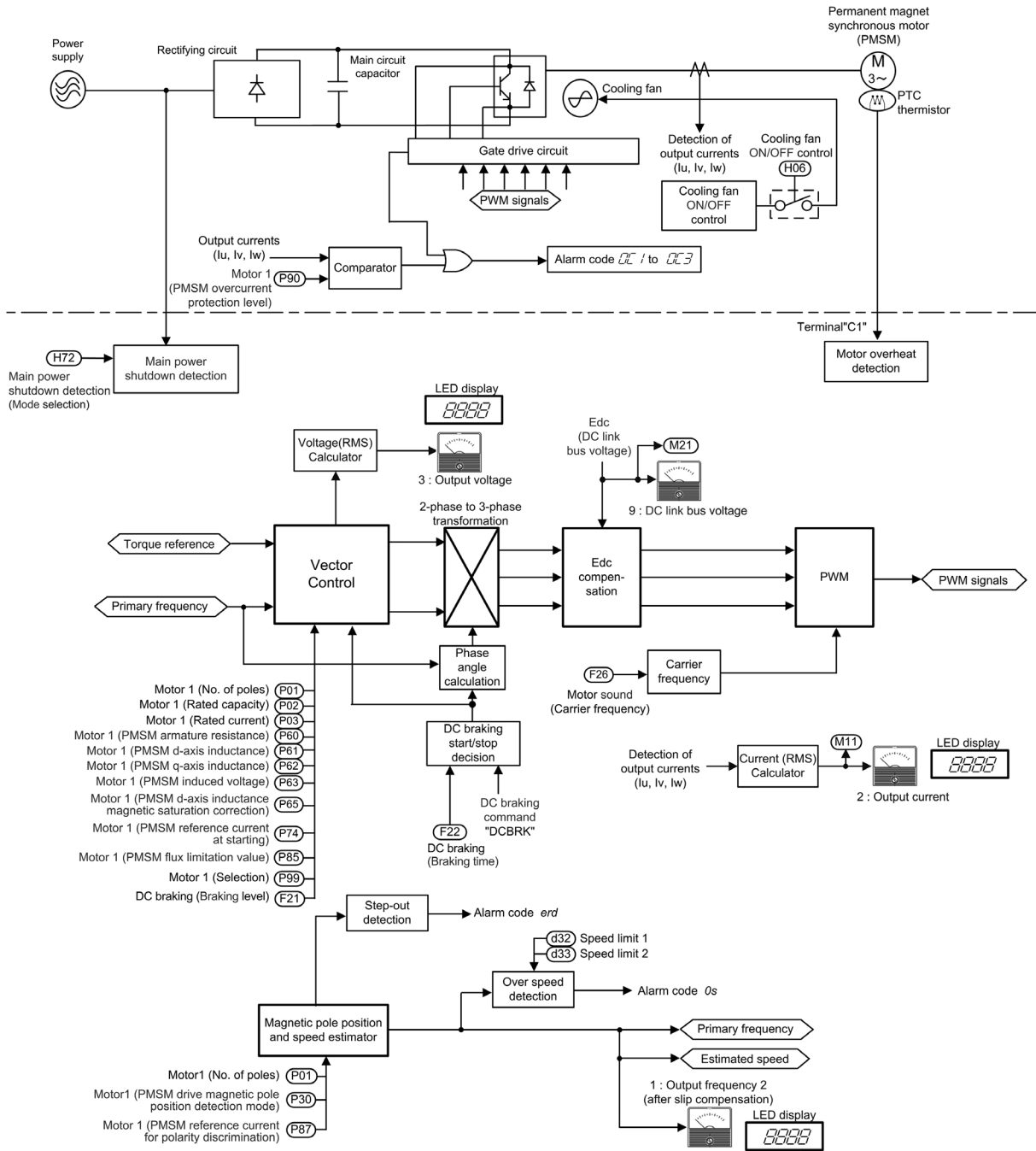

Figure 8.6-10 Vector Control (For PMSM) Section Block Diagram

8.7 FM Output Section

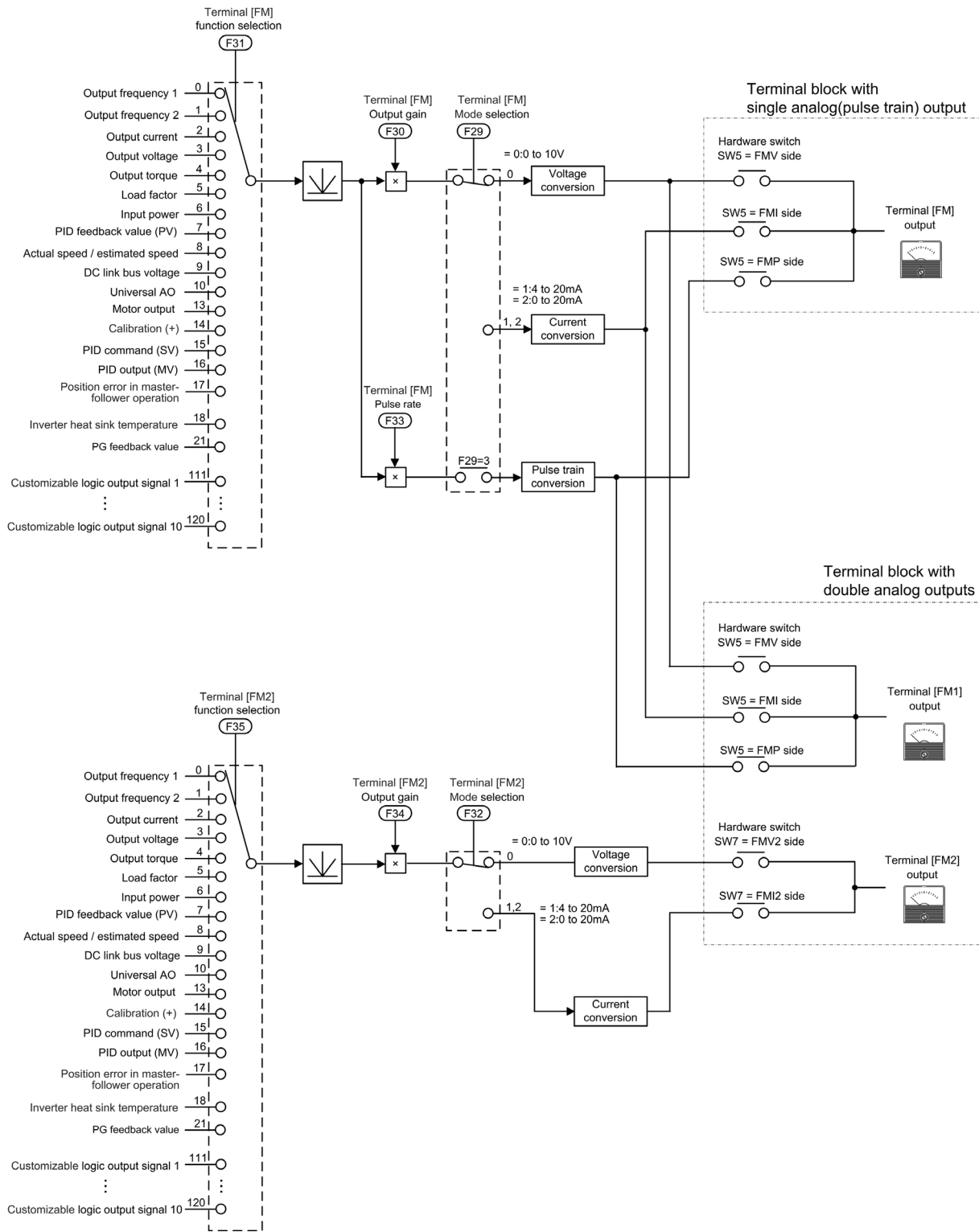

Figure 8.7-1 FM Output Section Block Diagram

Chapter 9

COMMUNICATION FUNCTIONS

This chapter describes an overview of inverter operation through the RS-485 and CANopen communications. For details of RS-485 communication, refer to the RS-485 Communication User's Manual.

Contents

9.1	Overview of RS-485 Communication	9-1
9.1.1	RS-485 common specifications	9-2
9.1.2	Terminal specifications	9-3
[1]	RS-485 communication port 1 (for connecting the keypad)	9-3
[2]	RS-485 communication port 2 (only for FRN-E2■-2/4/7GA, -2/4/7J)	9-4
[3]	RS-485 communication port 2 (terminal block) (only for FRN-E2■-2/4/7GB, -4C)	9-4
9.1.3	Connection method	9-5
9.1.4	RS-485 connection devices	9-8
[1]	Converter	9-8
[2]	Requirements for the cable (COM port 1: for RJ-45 connector)	9-9
[3]	Requirements for the cable (COM port 2: for RS-485 connector)	9-9
[4]	Branch adapter for multi-drop	9-9
9.1.5	RS-485 noise suppression	9-9
9.2	CANopen Communication	9-10
9.2.1	Modes	9-10
9.2.2	Connection method	9-11
[1]	Basic connection configuration	9-11
[2]	Terminal mode	9-12
9.2.3	Inverter function codes related to CANopen setting	9-13
9.2.4	Procedures to establish CANopen communication	9-15
9.2.5	PDO protocol	9-16
[1]	About PDO protocol	9-16
[2]	Receive PDO (from master to inverter)	9-17
[3]	Transmit PDO (from inverter to master)	9-19
[4]	Communication parameters of receive PDO	9-20
[5]	Communication parameters of transmit PDO	9-21
[6]	Changing PDO (RPDO/TPDO) mapping entry	9-22
9.2.6	SDO protocol	9-23
[1]	About SDO	9-23
[2]	Response on SDO error	9-23

9.2.7	Other services	9-24
9.2.8	Object list	9-25
[1]	Objects in the communication profile area	9-25
[2]	Objects in the profile area specific to Fuji Electric	9-31
9.2.9	Standard device profile area	9-32
9.2.10	Inverter operation in CANopen communication	9-33
[1]	Operation according to CANopen's drive profile (DSP 402)	9-33
[2]	Operation according to the inverter function code S06	9-38
9.2.11	Heartbeat and Node Guarding	9-42
[1]	Heartbeat	9-42
[2]	Node Guarding	9-43
9.2.12	Behavior upon detection of CANopen network disconnection	9-44
[1]	Related object and function code list	9-44
[2]	Restart from CANopen network disconnection failure	9-46
9.2.13	Alarm code list	9-47
9.2.14	Other points to note	9-48
9.2.15	Keypad LED operation monitor "3_40"	9-49
9.2.16	Keypad LED operation monitor "3_41"	9-49
9.2.17	Keypad LED operation monitor "3_42"	9-49
9.2.18	Keypad LED maintenance information "5_45"	9-49
9.2.19	Keypad LED maintenance information "5_46"	9-49
9.3	FRENIC Loader Overview	9-50
9.3.1	Modes	9-50
9.3.2	Connection	9-51
9.3.3	Function overview	9-51
[1]	Configuring inverter's function code	9-51
[2]	Multi-monitor	9-52
[3]	Running status monitor	9-53
[4]	Test-running	9-54
[5]	Real-time trace	9-55
[6]	Historical trace	9-56

9.1 Overview of RS-485 Communication

The FRENIC-Ace has two RS-485 communication ports at the locations shown below.

- (i) Communication port 1: RJ-45 connector for the keypad (modular jack)
- (ii) Communication port 2:
 RJ-45 connector for RS-485 communication (modular jack) * only for type FRN-E2■-2/4/7GA, -2/4/7J;
 RS-485 terminals (control circuit terminals SD, DX-, DX+) * only for FRN-E2■-2/4/7GB, -4C

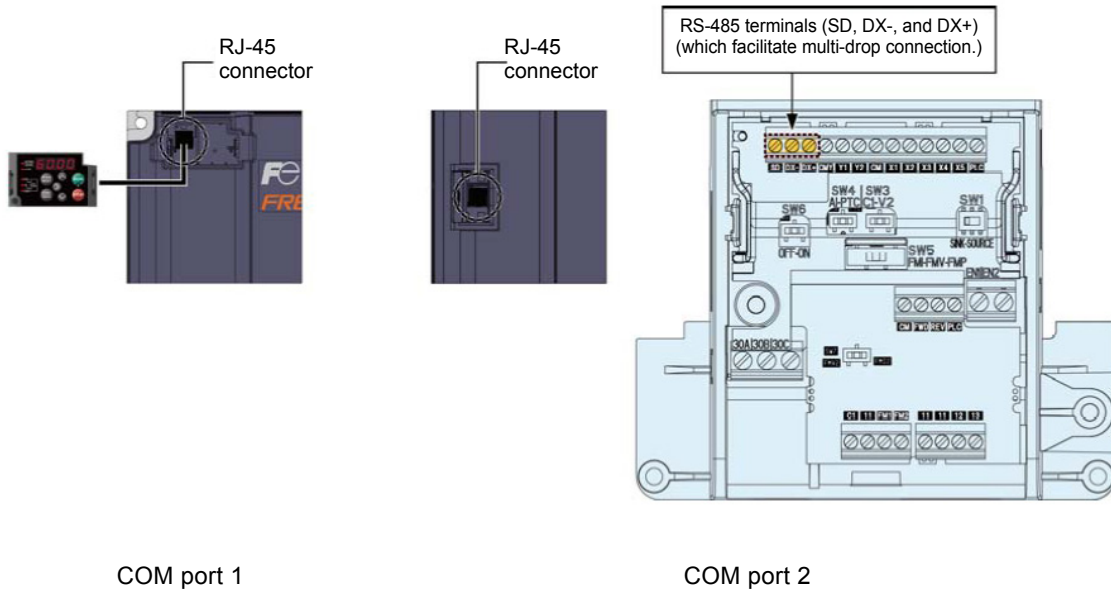

Using the RS-485 communication ports shown above enables the extended functions listed below.

- Remote operation from a keypad at the remote location (COM port 1)
 The standard keypad enables remote operation by mounting the keypad on a remote panel and connecting the keypad to RJ-45 connector with an extension cable. (maximum cable length: 20 m)
- Operation by FRENIC Loader (COM ports 1 and 2)
 It is possible to edit and monitor the function codes by connecting the RJ-45 connector (RS-485 communication) in the inverter and PC and using the inverter support loader (FRENIC Loader, see “9.3 FRENIC Loader Overview”).
- Control via host equipment (COM ports 1 and 2)
 Connecting the inverter to the host equipment (upper controller), such as a computer and programmable controller (PLC), enables to control the inverter as a subordinate device.

Besides the communication port 1 (RJ-45 connector) shared with the keypad, the FRENIC-Ace has the RS-485 communication port 2 by default.

The protocols for controlling inverters support the Modbus RTU protocol (compliant to the protocol established by Modicon Inc.) that is widely used and the Fuji Electric's general-purpose inverter protocol that is common to Fuji Electric's inverters including conventional series.



Note

- Connecting the keypad to the COM port 1 automatically switches to the keypad protocol; there is no need to modify the function code setting.
- When using FRENIC Loader, which requires a special protocol for handling Loader commands, you need to set up some communication function codes accordingly.

For details, refer to the FRENIC Loader Instruction Manual.



For details of RS-485 communication, refer to the RS-485 Communication User's Manual.

9.1.1 RS-485 common specifications

Item	Specifications		
Protocol	FGI-BUS	Modbus RTU	FRENIC Loader (support only for standard)
Compliance	Fuji general-purpose inverter protocol	Modicon Modbus RTU-compliant (only in RTU mode)	Dedicated protocol (Not disclosed)
Connection quantity	Host device: 1, Inverters: Up to 31		
Electrical mode	EIA RS-485		
Connection to RS-485	RJ-45 connector or terminal block		
Synchronization	Asynchronous		
Communication system	Half-duplex		
Transmission speed (bps)	2400, 4800, 9600, 19200 and 38400 bps		
Max. transmission cable length	500 m (1640 ft)		
Station No.	1 to 31	1 to 247	1 to 255
Message frame format	FGI-BUS	Modbus RTU	FRENIC Loader
Frame synchronization	Header character detection (SOH)	Detection of no-data time (for 3 characters period)	Header character detection (Start code: 96 _H)
Frame length	Normal transmission: 16 bytes (fixed) High-speed transmission: 8 or 12 bytes	Variable length	Variable length
Max. transfer data	Write: 1 word Read: 1 word	Write: 100 words Read: 100 words	Write: 41 words Read: 41 words
Messaging system	Polling/Selecting/Broadcast		Command message
Transmission character format	ASCII	Binary	Binary
Character length	8 or 7 bit Selectable with the function code	8 bits (fixed)	8 bits (fixed)
Parity	Even, Odd, or None (selectable by the function code)		Even (fixed)
Stop bit length	1 or 2 bit Selectable with the function code	Parity none: 2/1 bit Parity: 1 bit Select by parity setting.	1 bits (fixed)
Error checking	Sum-check	CRC-16	Sum-check

9.1.2 Terminal specifications

[1] RS-485 communication port 1 (for connecting the keypad)

The port designed for a standard keypad uses an RJ-45 connector having the following pin assignment:

Pin	Signal name	Description
1	Vcc	Power source for the keypad (5 V)
2	GND	Ground signal
3	NC	Not connected
4	DX-	RS-485 signal, low side *2
5	DX+	RS-485 signal, high side *2
6	NC	Not connected
7	GND	Ground signal
8	Vcc	Power source for the keypad (5 V)

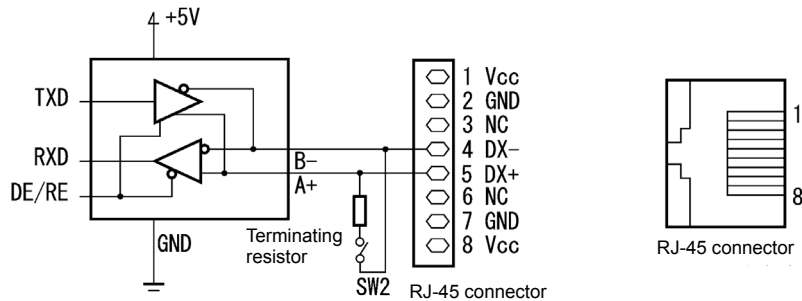

* The terminating resistor 112 Ω is built in. Open/close with SW2. *
For details about SW6, refer to Chapter 2, "2.2.8 Operating various switches."



The power supply for keypad is available in the RJ-45 connector for RS-485 communication (Pins 1, 2, 7, and 8). When connecting other devices to the RJ-45 connector, take care not to use those pins. Use pins **4 and 5 only**.

[2] RS-485 communication port 2 (only for FRN-E2■-2/4/7GA, -2/4/7J)

The RS-485 communication port 2 designed for a standard keypad uses an RJ-45 connector having the following pin assignment:

Pin	Signal name	Description
1	CAN+	CAN signal, high side
2	GND	Ground signal
3	CAN-	CAN signal, low side
4	DX-	RS-485 signal, low side
5	DX+	RS-485 signal, high side
6	NC	Not connected
7	GND	Ground signal
8	NC	Not connected

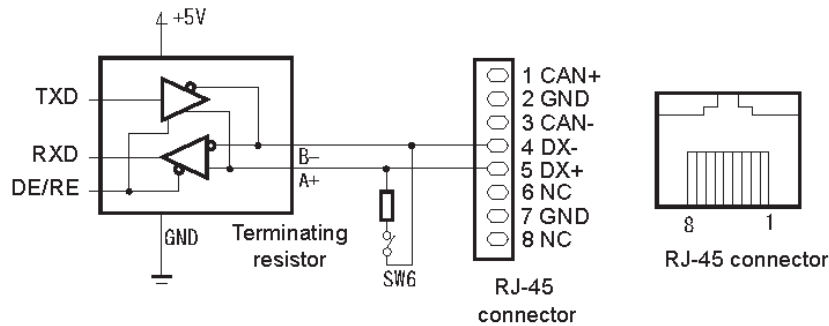

* The terminating resistor 112 Ω is built in. Open/close with SW6. *
For details about SW6, refer to Chapter 2, “2.2.8 Operating various switches.”

[3] RS-485 communication port 2 (terminal block) (only for FRN-E2■-2/4/7GB, -4C)

The FRENIC-Ace has terminals for RS-485 communication in the control circuit terminal. The details of each terminal are shown below.

Terminal symbol	Description	Remarks
SD	Shield terminal	
DX-	RS-485 signal, low side	Built-in terminating resistor: 112 Ω Open/close with SW6*
DX+	RS-485 signal, high side	

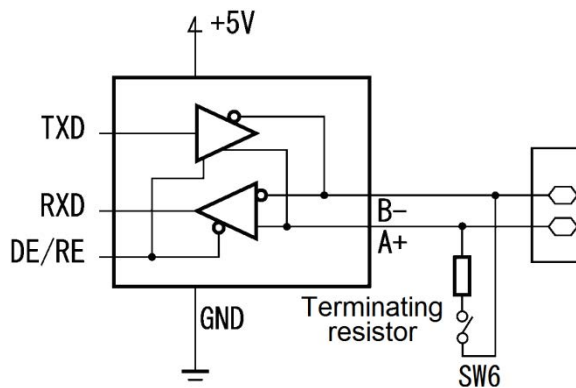

* The terminating resistor 112 Ω is built in. Open/close with SW6. *
For details about SW6, refer to Chapter 2, “2.4.2 Setting up the slide switches.”

9.1.3 Connection method

- Up to 31 inverters can be connected to one host equipment.
- The protocol is commonly used in the FRENIC series of general-purpose inverters, so programs for similar host equipment can run/stop the inverter.
(The parameters modes may differ depending on the equipment.)
- Fixed-length transmission frames facilitate developing communication control programs for hosts.

 For details of RS-485 communication, refer to the RS-485 Communication User’s Manual (MEH448).

Multi-drop connection using the RS-485 communication port 1 (for connecting the keypad)

For connecting inverters in multi-drop connection, use the branch adapters for multi-drop connection as shown below.

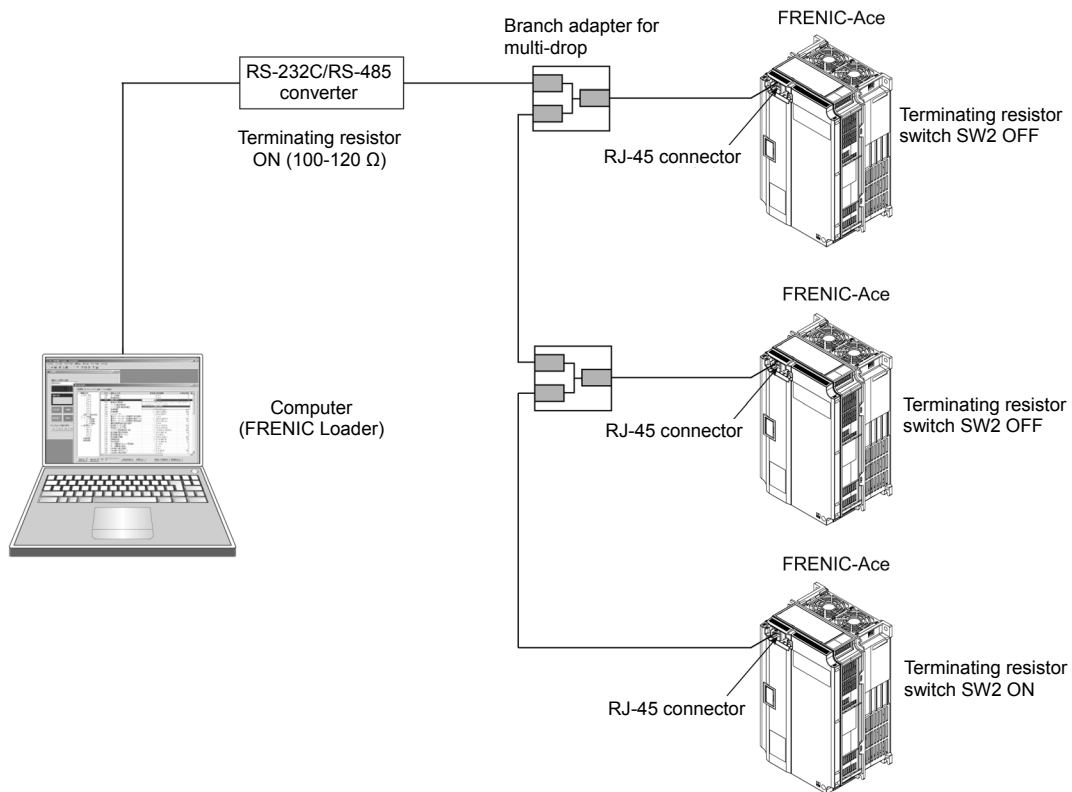

Figure 9.1-1 Multi-drop Connection for RS-485 Communication Port 1 (Using the RJ-45 Connector)



- The power supply for keypad is available in the RJ-45 connector for RS-485 communication (COM port 1) (pins 1, 2, 7 and 8). When connecting other devices to the RJ-45 connector, take care not to use those pins. Use pins **4 and 5 only**. (refer to “9.1.2 Terminal specifications”)
- When selecting additional devices to prevent the damage or malfunction of the control PCB caused by external noises or eliminate the influence of common mode noises, be sure to see “9.1.4 RS-485 connection devices.”
- The maximum wiring length must be 500 m.
- Use the cables and converters meeting the modes for connecting the RS-485 communication ports. (Refer to “[2] Requirements for the cable (COM port 1: for RJ-45 connector)” in “9.1.4 RS-485 connection devices”)

Multi-drop connection using the RS-485 communication port 2 (RJ-45 connector) (only for FRN-E2-2/4/7GA, J)

For connecting inverters in multi-drop connection, use the branch adapters for multi-drop connection as shown below.

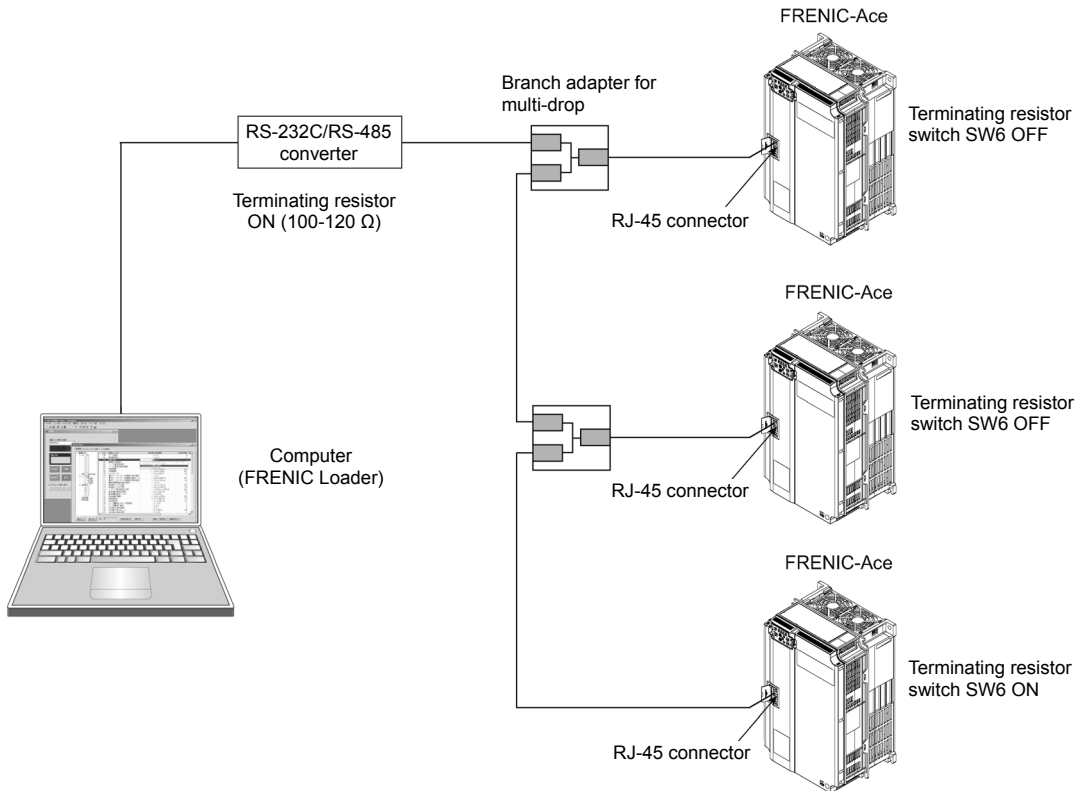

Figure 9.1-2 Multi-drop Connection for RS-485 Communication Port 2 (Using the RJ-45 Connector)

Note Use the cables and converters meeting the modes for connecting the RS-485 communication ports. (Refer to “[3] Requirements for the cable (COM port 2: for RS-485 connector)” in “9.1.4 RS-485 connection devices.”)

Multi-drop connection using the RS-485 communication port 2 (on the terminal block) (only for FRN-E2-2/4/7GB,-4C)

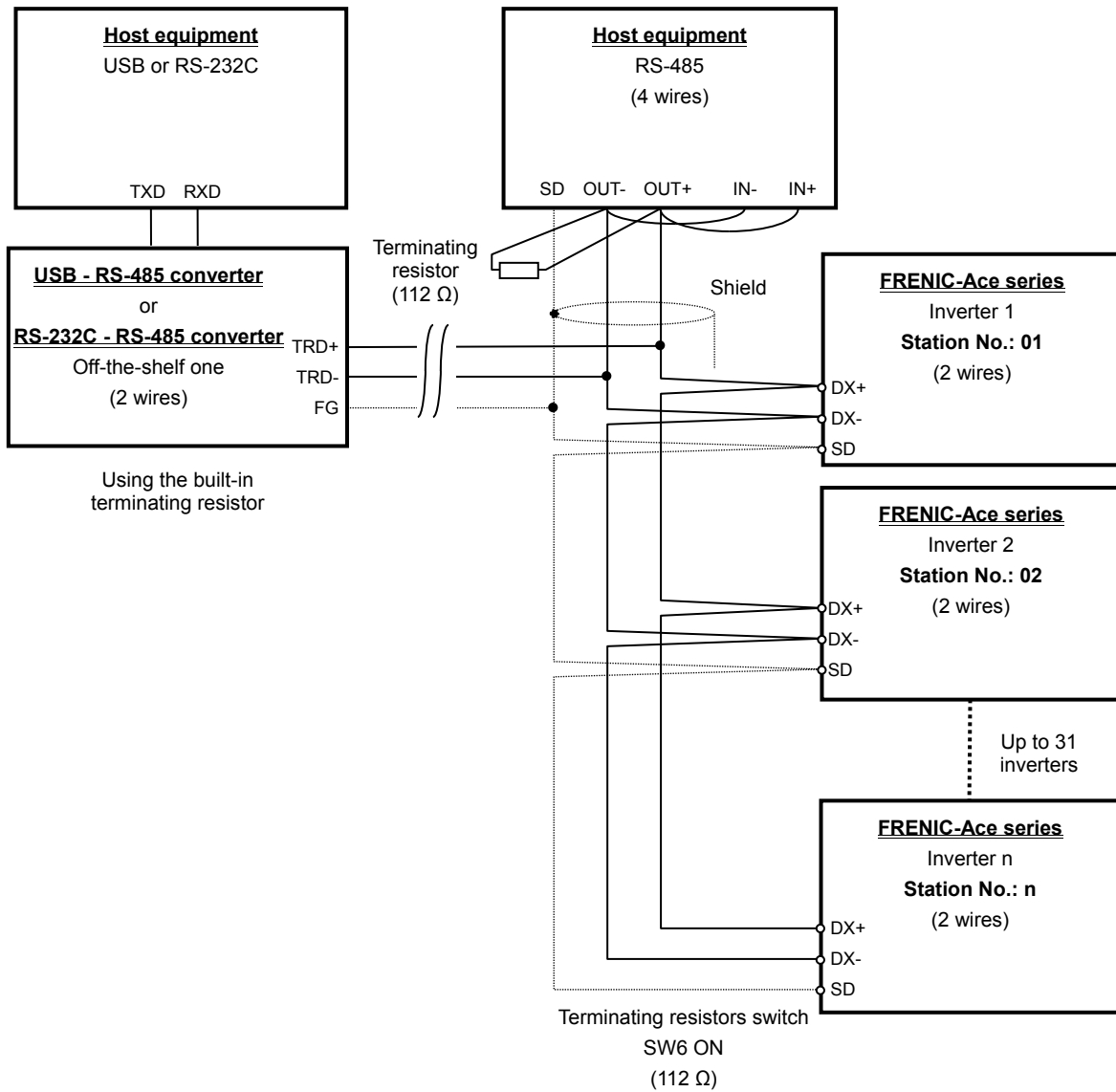

Figure 9.1-3 Multi-drop Connection Diagram (Connecting to the Terminal Block)



Use the cables and converters meeting the modes for connecting the RS-485 communication ports. (Refer to “[3] Requirements for the cable (COM port 2: for RS-485 connector)” in “9.1.4 RS-485 connection devices.”)

9.1.4 RS-485 connection devices

This section describes the devices required for connecting the inverter to a PC having no RS-485 interface or for connecting two or more inverters in multi-drop network.

[1] Converter

In general, PC is not equipped with an RS-485 port. Therefore, an RS-232C–RS-485 or USB–RS-485 converter is required. To use the equipment properly, be sure to use the converter which meets the mode below. Be careful that a converter not recommended may not work properly.

Requirements for recommended converters

Send/receive switching system: Auto-switching by monitoring the transmission data at PC (RS-232C)

Electric isolation: Electrically isolated from the RS-485 port

Fail-safe: Fail-safe facility (*)

Other requirements: Superior noise immunity

Note: The fail-safe function refers to a feature that ensures the RS-485 receiver's output is at "logic high" even if the RS-485 receiver's input is opened or short-circuited or all the RS-485 drivers are inactive. (Refer to "Figure 9.1-4 Communication Level Conversion".)

Recommended converters

System Sacom Sales Corporation (Japan) : KS-485PTI (RS-232C-RS-485 converter)
 : USB-485I RJ45-T4P (USB-RS-485 converter)

Send/receive switching system

The RS-485 communication system of the inverter acts in half-duplex mode (2-wire), so the converter must have a send/receive switching function. Generally, the switching system may be either one of the followings.

- (1) Auto-switching by monitoring the transmitted data
- (2) Switching by RS-232C control signal (RTS or DTR) from the computer

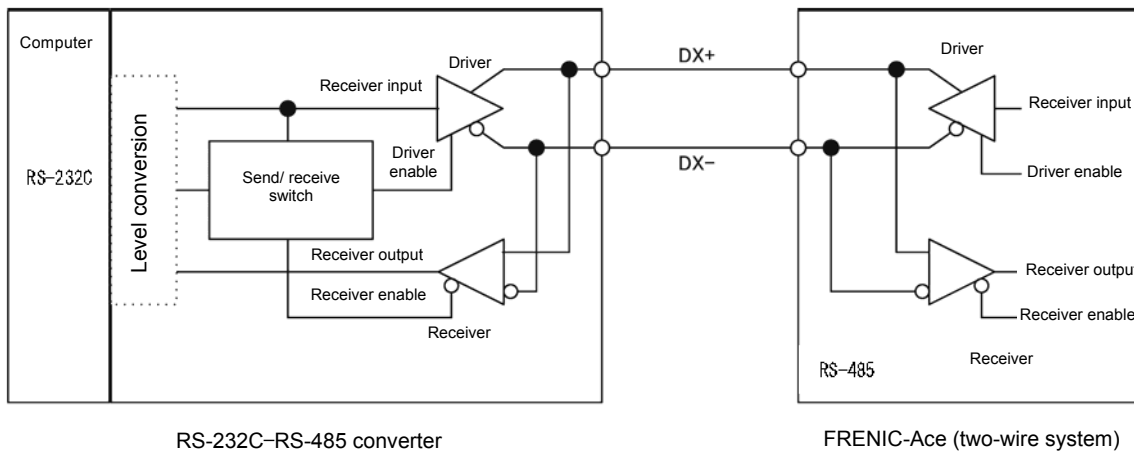

Figure 9.1-4 Communication Level Conversion

[2] Requirements for the cable (COM port 1: for RJ-45 connector)

Use a standard 10BASE-T/100BASE-TX LAN cable (US ANSI/TIA/EIA-568A category 5 compliant, straight cable).

Note The power supply for keypad is available in the RJ-45 connector for RS-485 communication (COM port 1) (pins 1, 2, 7 and 8). When connecting other devices to the RJ-45 connector, take care not to use those pins. Use pins **4 and 5 only**.

[3] Requirements for the cable (COM port 2: for RS-485 connector)

To ensure the reliability of connection, use twisted pair shield cables for long distance transmission AWG 16 to 26.

Recommended LAN cable manufacturer:

FURUKAWA Electric Co., LTD AWM2789 cable for long distance connection
 Type (Product code): DC23225-2PB

[4] Branch adapter for multi-drop

The RJ-45 connector is used as the communication connector. To use a standard LAN cable for multi-drop connection, use the branch adapter for the RJ-45 connector.

Recommended branch adapter

SK Koki (Japan): MS8-BA-JJJ

9.1.5 RS-485 noise suppression

Depending on the operating environment, the malfunction may occur due to the noise generated by the inverter. Possible measures to prevent such malfunction are: separating the wiring, use of shielded cable, isolating the power supply, and adding an inductance component. The description shown below is an example of adding an inductance.

📖 Refer to the RS-485 Communication User’s Manual, Chapter 2, Section 2.2.4 “Precautions for long wiring (between inverter and motor)” for details.

Adding inductance components

Keep the impedance of the signal circuit high against the high-frequency noises by inserting an inductance component, such as by inserting a choke coil in series or passing the signal line through a ferrite core.

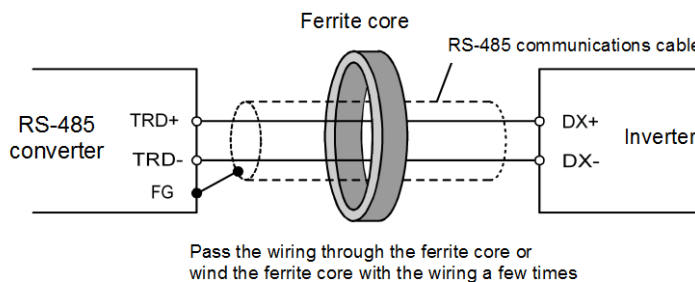

Figure 9.1-5 Adding an Inductance Component

9.2 CANopen Communication

9.2.1 Modes

Table 9.2-1 lists the CANopen modes. The CANopen mode will apply to the items not contained in the table below.

Table 9.2-1 CANopen Mode

Item	Modes	Remarks
Physical layer	CAN (ISO11898) (High speed)	
Node ID	1 to 127	Can be set by the inverter function code y21 / o31
Baud rate	20k, 50k, 125k, 250k, 500k, 800k, 1Mbit/s	Can be set by the inverter function code y24 / o32
Maximum cable length	Refer to Table 9.2-3	Twisted pair cable (shielded)
No. of connection units	30 (MAX)	Loop bus
Protocol version	Standard format (2.0A)	
Profile	Compliant with the following profiles; <ul style="list-style-type: none"> • CiA DS 301 Ver.4.02 • CiA DSP 402 Ver.2.0 Velocity Mode 	
PDO	<ul style="list-style-type: none"> • Receive PDO and Transmit PDO, three types each • PDO assignment cannot be changed 	Refer to Section 9.2.5
SDO	<ul style="list-style-type: none"> • Supports one Server SDO 	Refer to Section 9.2.6
Other services	<ul style="list-style-type: none"> • Network Management(NMT) Start_Remote_Node, Stop_Remote_Node, Enter_Pre-Operational, Reset_Communication, Reset_Node • Heartbeat (Producer and Consumer) • Node Guarding • Emergency (EMCY) 	Refer to Section 9.2.7



The built-in CANopen and option communication cards cannot be used at the same time.
The built-in CANopen is not supported in FRN-E2■-2/4GB, -4C.

9.2.2 Connection method

⚠ WARNING ⚠

- Before the connection, shut off the inverter’s power source and wait 5 min (FRN0115E2■-2□ or below, FRN0072E2■-4□ or below, FRN0011E2■-7□ or below) or 10 min (FRN0085E2■-4□ or above) or more. Furthermore, confirm that the LED monitor / charge lamp are turned off and that the DC link bus voltage of main circuit terminals between P (+) and N (-) indicates the safety value (+25 VDC or less) by using a tester.
- A qualified specialist should perform the wiring work.

An electric shock may occur.

- In general, since the cover of the control signal line is not reinforcedly insulated, direct current flow in the control signal line from the main circuit’s live parts, may destroy the insulation cover. If this is the case, high voltage from the main circuit may be applied to the control lines. Be careful to avoid main circuit’s live part comes in contact with the control signal lines.

It may cause an accident or fire.

⚠ CAUTION ⚠

The noise may be generated from the inverter, motor, and cables. Be careful about malfunction of surrounding sensor and equipment.

Otherwise an accident could occur.

[1] Basic connection configuration

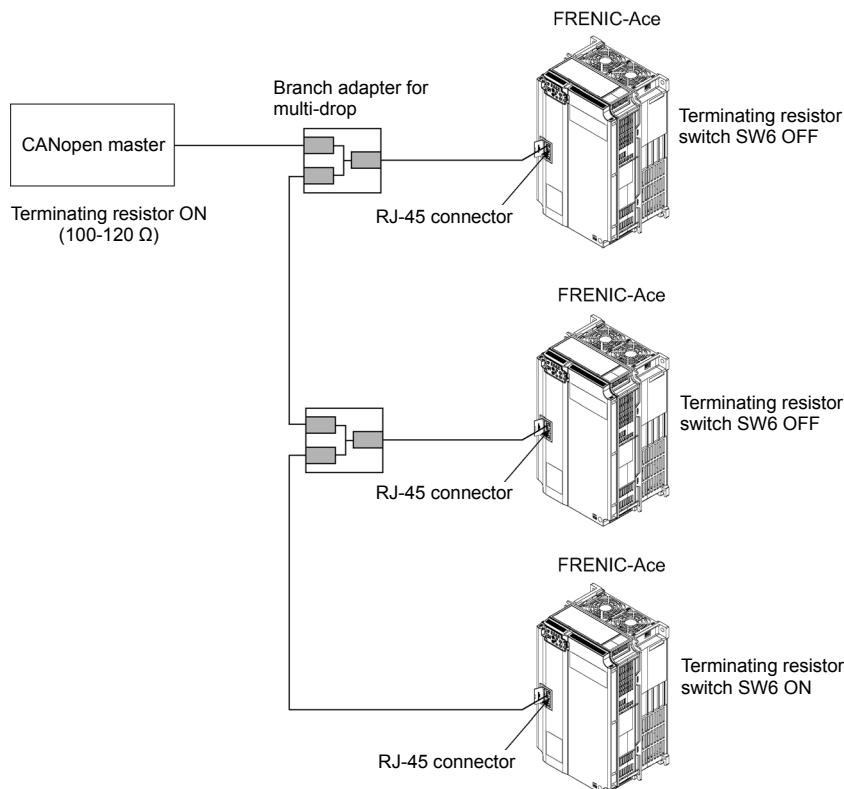

Figure 9.2-1 Multi-drop Connection for CANopen Communication Port 2 (Using the RJ-45 Connector)

[2] Terminal mode

(1) RJ-45 connector (COM port 2) for CANopen communication

Figure 9.2-2 and Table 9.2-2 show the pinout and signal description.

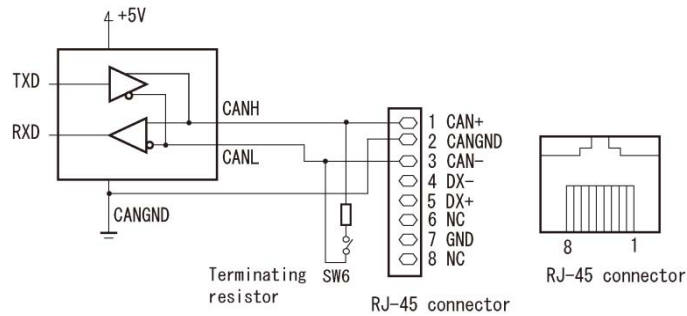

Figure 9.2-2 RJ-45 connector's Pinout for CANopen Communication

Table 9.2-2 CANopen's signals

Pin	Signal name	Description
1	CAN+	CAN signal, high side *1
2	CANGND	CAN ground signal *3
3	CAN-	CAN signal, low side *1
4	DX-	RS-485 signal, low side *2
5	DX+	RS-485 signal, high side *2
6	NC	Not connected
7	GND	Ground signal
8	NC	Not connected

*1: The pins used in the CANopen communication are the pin nos 1 and 3.

*2: These Pins No. 4 and 5 are for RS-485 communication.

*3: This pin is the ground one for CAN bus. In order to reduce the influence of the noise as much as possible, it is recommended to use this pin.

(2) CANopen communication cable

Use a standard LAN cable (US ANSI/TIA/EIA-568A category 5 compliant, straight cable) for the communication. Table 9.2-3 lists the maximum cable lengths.

Table 9.2-3 Maximum CANopen Cable Length

Baud rate (bit/s)	20 k	50 k	125 k	250 k	500 k	800 k	1 M
Maximum cable length	2500m	1000m	500 m	250m	100m	50m	25m

(3) Connecting a terminating resistor

When the inverter is connected to either end of CANopen communication cable, set the terminating resistor (SW6=ON). SW6 is shared between RS-485 communications and CAN bus communications.

If these communications are used together and the terminating resistor is placed in each inverters, turn SW6 "OFF" and use an external terminating resistor if required. For details, refer to Chapter 2 "2.2.8 Operating various switches".

9.2.3 Inverter function codes related to CANopen setting

In order to use this communication card for the CANopen communication, it is required to set the inverter function code listed in Table 9.2-4 shown below. Also, Table 9.2-5 lists the related inverter function codes. Set the codes, if necessary.

Table 9.2-4 Inverter Function Codes Necessary for CANopen Communication

Function code	Name	Default setting	Function code data to be set	Remarks															
y21 / o31 ^{*1}	Node-ID	0	Sets the node-ID, 1 to 127																
y24 / o32 ^{*2}	Baud rate	0	Sets a baud rate, 0 to 7 0: 125 kbit/s, 1: 20 kbit/s, 2: 50 kbit/s, 3: 125 kbit/s, 4: 250 kbit/s, 5: 500 kbit/s, 6: 800 kbit/s, 7: 1 Mbit/s, 8 or more: 1 Mbit/s,	Set the same value as the master's baud rate.															
y33	Operation selection	0	0: Operation disabled (Bus option enabled) 1: Operation enabled (Built-in CAN enabled; bus option disabled)																
y34	Communications error processing	0	0 to 12 For details, refer to "9.2.12 Behavior upon detection of CANopen network disconnection".																
y35	Communication time-out detection timer	0.0	0.0 to 60.0s For details, refer to "9.2.12 Behavior upon detection of CANopen network disconnection".																
y36	Operation selection in abort status	1	-5 to 3 Same as the Object 6007 in DSP-402. For details, refer to "9.2.12 Behavior upon detection of CANopen network disconnection".																
y98 ^{*3}	Bus link function (Mode selection)	0	Select from the following alternatives: <table border="1" style="margin-left: 20px;"> <thead> <tr> <th>y98</th> <th>Frequency</th> <th>Operation</th> </tr> </thead> <tbody> <tr> <td>0</td> <td>Inverter</td> <td>Inverter</td> </tr> <tr> <td>1</td> <td>CANopen</td> <td>Inverter</td> </tr> <tr> <td>2</td> <td>Inverter</td> <td>CANopen</td> </tr> <tr> <td>3</td> <td>CANopen</td> <td>CANopen</td> </tr> </tbody> </table>	y98	Frequency	Operation	0	Inverter	Inverter	1	CANopen	Inverter	2	Inverter	CANopen	3	CANopen	CANopen	The setting y98=3 is recommended.
y98	Frequency	Operation																	
0	Inverter	Inverter																	
1	CANopen	Inverter																	
2	Inverter	CANopen																	
3	CANopen	CANopen																	
H81	Light Alarm Selection 1	0000 _H	Bit 14: Assign $\bar{E}-\bar{L}$ to light alarm. For details, refer to "9.2.12 Behavior upon detection of CANopen network disconnection" and Chapter 5 "5.3 Description of Function Codes".																
C89	Frequency correction via communication 1 (Numerator)	1	The data set with 604B is written in the inverter.																
C90	Frequency correction via communication 2 (Denominator)	1	The data set with 604B is written in the inverter.																

*1: If y21/o31 is set, in order to reflect the setting in the inverter, restart the inverter or issue the ResetNode service to inverter from the CANopen master.

*2: If y24/o32 is set, in order to reflect the setting in the inverter, restart the inverter.

*3: Besides y98, there is an inverter function code to select the running and frequency command source. These settings enable to select the running and frequency command source in detail. For more information, refer to the H30 and y98 pages in Chapter 5 "FUNCTION CODES".

Table 9.2-5 Related Function Codes

Function code	Description	Default setting	Data setting range	Remarks
y34 / o27 ^{*1}	Selects the behavior on CANopen communication error	0	0 to 15	
y35 / o28 ^{*1}	Timer on CANopen communication error	0.0 s	0.0 s to 60.0 s	
y25 to y28 / o40 to o43 ^{*2}	Sets the inverter function code (write) to be mapped to RPDO No. 3	0 (no mapping)	0000 to FFFF (hex)	This setting is used in PDO No. 3.
y29 to y32 / o48 to o51 ^{*2}	Sets the inverter function code (read) to be mapped to TPDO No. 3	0 (no mapping)	0000 to FFFF (hex)	

*1: For more information on y34 / o27 and y35 / o28, refer to “9.2.12 Behavior upon detection of CANopen network disconnection”.

*2: For information on how to set y25 to y28 / o40 to o43 and y29 to y32 / o48 to o51, refer to “9.2.5 [2] Receive PDO (from master to inverter)”, “(4) How to set the inverter function codes y25 to y32/o40 to o43, o48 to o51 and Indexes 5E00, 5E01”.

After the setup, in order to reflect the settings in the inverter, restart the inverter or issue the ResetNode service to inverter from the CANopen master.

9.2.4 Procedures to establish CANopen communication

This chapter describes the procedures to connect the CANopen communication between the master and inverter. The procedure is as follows (steps 1 to 5).

1. Set the CANopen master
2. Set the node ID and baud rate of inverter by specifying the inverter function codes.
3. Restart the inverter and put the inverter in a pre-operational state
4. Set the object for detecting disconnection (Heartbeat or Node Guarding)
5. Transmit the Start Remote Node command from the master to the inverter to put the inverter in an operational state

Steps 1 to 5 are described below in detail.

1. Set the CANopen master

- Set the node ID and baud rate of the master.
- Use the inverter's EDS file to register it in the master (for the CANopen communication).



For information about how to set the CANopen master, refer to the master's user's manual.



The EDS file is not delivered with the inverter.

Download the EDS file from the following Web site. (required to subscribe (charge-free))

URL: <http://www.fujielectric.com/products/##tab2/tab1>

2. Set the node ID and baud rate of inverter by specifying the inverter function codes.

- Set the node ID with y21 / o31 and the baud rate with y24 / o32. Set the same values as those configured in the master.
- If necessary, set the inverter function codes y34 / o27, y35 / o28.



For more information on y34 / o27 and y35 / o28, refer to "9.2.12 Behavior upon detection of CANopen network disconnection".

3. Restart the inverter and put the inverter in a pre-operational state

If the settings of the CANopen master and inverter are correct and the wiring is properly done, the inverter automatically enters into pre-operational state, enabling to communicate with the master.

In this state, RUN LED blinks in green and ERR LED turns off or blinks in red in the optional communication card (OPC-E2-COP).

In the case of the built-in CANopen, check the condition with LED drive monitor "3_40".



For information about status monitor, refer to "9.2.15 Keypad LED operation monitor "3_40"".

4. Set the object for detecting disconnection (Heartbeat or Node Guarding)

In order to detect the disconnection, set Heartbeat or Node Guarding in both master and inverter.



For information about Heartbeat or Node Guarding, refer to "9.2.11 Heartbeat and Node Guarding".



The object for detecting disconnection in the CANopen device is invalid by default. Unless the setting is enabled, the CANopen network including inverter cannot detect a disconnection even if the disconnection occurs. We strongly recommend to enable the setting.

5. Transmit the Start Remote Node command from the master to inverter to put the inverter in an operational state

After receiving this command, the inverter enters the operational state. This enables the master to control and monitor the inverter real time through the PDO communication.



For information about the format of PDO communication, refer to "9.2.5 PDO protocol".

9.2.5 PDO protocol

[1] About PDO protocol



The PDO (Process Data Object) protocol is used for communicating the process data between the CANopen master and inverter periodically (example: running command, speed monitoring). As shown in Table 9.2-6 and Table 9.2-7, CANopen communication of inverter supports three types of receive PDO (RPDO: from master to inverter) and transmit PDO (TPDO: from inverter to master) each.

Table 9.2-6 Receive PDO (RPDO, from master to inverter)

PDO No.	Initial value of COB-ID	Description
1	0x200 + node ID	Controls the state change of DS-402
2	0x300 + node ID	Controls the state change of DS-402 and the speed command
3	0x400 + node ID	Writes four types of mapped inverter function codes

Table 9.2-7 Transmit PDO (TPDO, from inverter to master)

PDO No.	Initial value of COB-ID	Description
1	0x180 + node ID	Controls the state change of DS-402
2	0x280 + node ID	Controls the state change of DS-402 and the speed command
3	0x380 + node ID	Reads four types of mapped inverter function codes

-  **Note** Transfer timing of transmit PDO
The factory default is “change of state event”. For more information, refer to “9.2.5 [5] Communication parameters of transmit PDO”, “(3) Transmission type”.
-  **Note** Enable/disable setting of PDO
All PDOs are valid by factory default. Set the bit 31 in COB-ID of each PDO to one in order to invalidate the PDO (nonresponse).
-  **Note**
The PDO protocol is available for use only in operational state.
It is recommended to change the PDO protocol when the inverter is in the Pre-Operational state.

[2] Receive PDO (from master to inverter)**(1) Receive PDO No.1**

PDO No.	Default COB-ID	Name	Re-map
1	0x200+Node ID	Control word (Default)	Yes
		User-defined	Yes
		User-defined	Yes
		User-defined	Yes

Controlword: Controls the inverter's operation by operating the state machine with DSP 402

 For information about Controlword and state machine with DSP 402, refer to "9.2.10 [1] Operation according to CANopen's drive profile (DSP 402)".

(2) Receive PDO No.2

PDO No.	Default COB-ID	Name	Re-map
2	0x300+Node ID	Control word (Default)	Yes
		vl target velocity (r/min) (Default)	
		User-defined	Yes
		User-defined	Yes

Controlword: Controls the inverter's operation by operating the state machine with DSP 402

vl target velocity: Speed command (r/min)

 For information about Controlword, vl control effort, and state machine with DSP 402, refer to "9.2.10 [1] Operation according to CANopen's drive profile (DSP 402)".

 **Note** When you give the speed command (r/min), set the number of motor poles (P01/A15) properly according to the applicable motor; otherwise the speed command (r/min) will be incorrect.

(3) Receive PDO No.3

This PDO is the ability to write data to the function code that is specified in advance. There are four types of mapped function codes.

PDO No.	Default COB-ID	Name	Re-map
3	0x400+Node ID	Writing function code 1 (function code data specified by y25/o40)	No
		Writing function code 2 (function code data specified by y26/o41)	
		Writing function code 3 (function code data specified by y27/o42)	
		Writing function code 4 (function code data specified by y28/o43)	

 For information on how to set y25 to y28/o40 to o43, refer to "9.2.5 [2] (4) How to set the inverter function codes y25 to y32/o40 to o43, o48 to o51 and Indexes 5E00, 5E01".

 For information about data format of the mapped inverter function codes, refer to RS-485 Communication User's Manual, Chapter 5 "5.2 Data Format".

 **Note** When the same function code is assigned by multiple inverter function codes, only the assignment by the y / o code of the minimum number will be valid. (Example: If the same function code is mapped by both o40 and o43, only the mapping with y25 / o40 becomes effective. y28 / o43 is assumed as nothing is mapped.)

 **Note** After the setup of y25 to y28 / o40 to o43, in order to make effective the settings in the inverter, restart the inverter or issue the ResetNode service to the inverter from the CANopen master.

 **Note** The object's Indexes 5E00 sub 1 to 4 also can map the inverter function codes. In this case, the mappings become effective immediately after the change. However, if the inverter is restarted or the ResetNode service is issued, the mappings by y25 to y28 / o40 to o43 become effective.

 **Note** The timing to make effective each receive PDO can be changed. Refer to "9.2.5 [4] Communication parameters of receive PDO", "(3) Transmission type". The "change is reflected in the inverter immediately after receive" by factory default.

(4) How to set the inverter function codes y25 to y32/o40 to o43, o48 to o51 and Indexes 5E00, 5E01

Specify the function code type (Table 9.2-8) and number in a 4-digit hexadecimal notation.

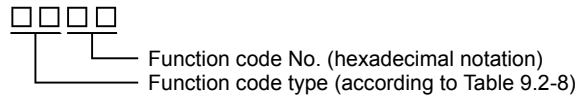

Table 9.2-8 Function Code Types

Type	Group code	Type	Group code	Type	Group code
—	—	W	0x10 (16)	H1	0x20 (32)
—	—	X	0x11 (17)	o1	0x21 (33)
S	0x02 (2)	Z	0x12 (18)	U1	0x22 (34)
M	0x03 (3)	b	0x13 (19)	M1	0x23 (35)
F	0x04 (4)	d	0x14 (20)	J1	0x24 (36)
E	0x05 (5)	—	—	J2	0x25 (37)
C	0x06 (6)	—	—	J3	0x26 (38)
P	0x07 (7)	W1	0x17 (23)	J4	0x27 (39)
H	0x08 (8)	W2	0x18 (24)	J5	0x28(40)
A	0x09 (9)	W3	0x19 (25)	J6	0x29(41)
o	0x0A (10)	X1	0x1A (26)	d1	0x2A (42)
L	0x0B (11)	X2	0x1B (27)		
r	0x0C (12)	Z1	0x1C (28)		
L1	0x0D (13)	K	0x1D(29)		
J	0x0E (14)	T	0x1E(30)		
y	0x0F (15)	E1	0x1F (31)		

Example: For F26 F ⇒ group code 04
 26 ⇒ 1A (hexadecimal notation) } "041A"

[3] Transmit PDO (from inverter to master)**(1) Transmit PDO No.1**

PDO No.	Default COB-ID	Name	Re-map
1	0x180+Node ID	Status word (Default)	Yes
		User-defined	Yes
		User-defined	Yes
		User-defined	Yes

Statusword: Display the status of state machine with DSP 402

 For information about Statusword and state machine with DSP 402, refer to “9.2.10 [1] Operation according to CANopen’s drive profile (DSP 402)”.

(2) Transmit PDO No.2

PDO No.	Default COB-ID	Name	Re-map
2	0x280+Node ID	Status word (Default)	Yes
		vl control effort (r/min) (Default)	
		User-defined	Yes
		User-defined	Yes

Statusword: Display the status of state machine with DSP 402

vl control effort: Monitor output speed (r/min)

 For information about Statusword and vl control effort, refer to “9.2.10 [1] Operation according to CANopen’s drive profile (DSP 402)”.

(3) Transmit PDO No.3

This PDO is the ability to read data from the function code that is specified in advance. There are four types of mapped function codes.

PDO No.	Default COB-ID	Name	Re-map
3	0x380+Node ID	Reading function code 1 (function code data specified by y29/o48)	No
		Reading function code 2 (function code data specified by y30/o49)	
		Reading function code 3 (function code data specified by y31/o50)	
		Reading function code 4 (function code data specified by y32/o51)	

 For information on y29 to y32/o48 to o51, refer to “9.2.5 [2] Receive PDO (from master to inverter)”, “(4) How to set the inverter function codes y25 to y32/o40 to o43, o48 to o51 and Indexes 5E00, 5E01”.

 For information about data format of the mapped inverter function codes, refer to RS-485 Communication User’s Manual, Chapter 5, “5.2 Data Format”.

 **Note** After the setup of y29 to y32/o48 to o51, in order to make effective the settings in the inverter, restart the inverter or issue the ResetNode service to the inverter from the CANopen master.

 **Note** The object indexes 5E01 sub 1 to 4 can map the inverter function codes. In this case, the mappings become effective immediately after the change. However, if the inverter is restarted or the ResetNode service is issued, the mappings with y29 to y32/o48 to o51 become effective.

 **Note** The transmission timing of each transmit PDO can be changed. Refer to “9.2.5 [5] Communication parameters of transmit PDO, “(3) Transmission type”. The factory default is “Transmit PDO upon data change and at the time specified by Event timer”.

[4] Communication parameters of receive PDO**(1) Communication parameters**

Set the property of each receive PDO (RPDO). The Table 9.2-9 lists appropriate objects.

Table 9.2-9 Communication Parameters of Receive PDO and Default Values

Index	Sub	Name	Description
0x1400 RPDO No.1 0x1401 RPDO No.2 0x1402 RPDO No.3	1	COB-ID	Set CAN ID of each PDO and validity Default value: RPDO No.1: 0x200 + node ID RPDO No.2: 0x300 + node ID RPDO No.3: 0x400 + node ID
	2	Transmission type	Set the timing to reflect the received data in the operation (Table 9.2-10) Default value: 255 (reflect it in the inverter immediately)

 **Note** The value changed of the objects listed in the Table 9.2-9 is held even if inverter is turned OFF.

(2) COB-ID

Specify 11 bit CAN ID value for each PDO. The default value changes according to the node ID.
(Example: If the node ID of inverter is one, RPDO No.2 COB-ID = 0x301). If the most significant bit (31th bit) is set to one, the RPDO will be invalid.

 **Note** It is possible to change COB-ID only when the PDO is invalid.

 **Tip** CAN ID is 11 bit. The bits 11 to 30 are fixed at zero. (Only the standard frame is supported.)

(3) Transmission type

In the receive PDO, set the timing to reflect the received PDO in the inverter. The Table 9.2-10 lists the setting.

Table 9.2-10 Transmission Type Setting of Receive PDO

Transmission type	Name	Action
0	Acyclic Synchronous	Reflects the received PDO in the inverter after receiving a Sync signal
1-240	Cyclic Synchronous	Same as above
241-251	Reserved	---
252	Synchronous RTR only	No operation *
253	Asynchronous RTR only	No operation *
254	Asynchronous1	Reflects the received PDO immediately in the inverter
255	Asynchronous2	Same as above (default)

*: The CANopen communication of inverter does not support the CAN's remote frame.

[5] Communication parameters of transmit PDO**(1) Communication parameters**

Set the property of each transmit PDO (TPDO). The Table 9.2-11 lists appropriate objects.

Table 9.2-11 Communication Parameters of Transmit PDO and Default Values

Index	Sub	Name	Description
0x1800 TPDO No.1 0x1801 TPDO No.2 0x1802 TPDO No.3	1	COB-ID	Set CAN ID of each PDO and validity Default value: TPDO No.1: 0x180 + node ID TPDO No.2: 0x280 + node ID TPDO No.3: 0x380 + node ID
	2	Transmission type	Specify the transmission timing (Table 9.2-12) Default value: 255 (transmit data if the data changes)
	3	Inhibit time	Specify the minimum interval (unit: 0.1 ms) to next transmission. Default value: 100 (10.0 ms) *
	5	Event timer	Specify periodical transmission time (ms). Valid when the transmission type is 254/255 Default value: 0 (no operation) *

*: The resolution of timer setting value is 2 ms. If an odd value is specified, the value assumed is the following higher even value. For example, if the timer is set to 119 ms, the value is assumed to be 120 ms.



The value changed of the objects listed in the Table 9.2-11 is held even if inverter is turned OFF.

(2) COB-ID

Specify 11 bit CAN ID value for each PDO. The default value changes according to the node ID. (Example: If the node ID of inverter is one, TPDO No.2 COB-ID = 0x281). If the most significant bit (31th bit) is set to one, the TPDO will be invalid.



It is possible to change COB-ID only when the PDO is invalid.



CAN ID is 11 bit. The bits 11 to 30 are fixed at zero. (Only the standard frame is supported.)

(3) Transmission type

Set the transmission timing to the master for the transmit PDO. The Table 9.2-12 lists the settings.

Table 9.2-12 Transmission Type Setting of Transmit PDO

Transmission type	Name	Action
0	Acyclic Synchronous	When the data is changed, transmits PDO immediately after receiving a Sync signal
1-240	Cyclic Synchronous	Transmits PDO every 1 to 240 times a sync signal is received. (Example: (if it is set to 10, transmits PDO every 10 times a sync signal is received))
241-251	Reserved	-
252	Synchronous RTR only	No operation *
253	Asynchronous RTR only	No operation *
254	Asynchronous1	Transmits PDO periodically at the time specified by Event timer
255	Asynchronous2	Transmit PDO upon data change and at the time specified by Event timer

*: The CANopen communication of inverter does not support the CAN's remote frame.

(4) Inhibit time

Set the minimum transmission interval (unit: 0.1 ms) for transmitting each PDO. All transmission types depend on this setting.

 **Note** It is possible to change Inhibit time only when the PDO is invalid, that is, COB-ID's bit 31 is set to one.

 **Note** If a smaller value is set for the Inhibit time, the data transmission frequency becomes higher, thereby increasing the CANopen communication traffic. As a result, the performance of the whole CANopen network may be degraded. Please adjust the setting value according to the network configuration used.

(5) Event timer

Set the periodical transmission interval (unit: 1 ms) for transmit PDO. Valid when the transmission type is 254 or 255.

[6] Changing PDO (RPDO/TPDO) mapping entry

Follow the procedure below to change mapping entries:

- (1) Disable the PDO by changing the bit 31 of the relevant COB-ID entry to "1".

Example) RPDO: Index 0x1400, Subindex 1, Bit31 = 1
 TPDO: Index 0x1800, Subindex 1, Bit31 = 1

- (2) Disable the PDO mapping by writing 0h in the subindex 0h of the relevant mapping entry.

Example) RPDO: Disable the current mapping and set Index 0x1600, Subindex 0 = 0.
 TPDO: Disable the current mapping and set Index 0x1A00, Subindex 0 = 0.

- (3) Configure the target new PDO mapping.

Example) RPDO: Index 0x1600, Subindex 1 through 4 = New object
 TPDO: Index 0x1A00, Subindex 1 through 4 = New object

- (4) Set the subindex 0h of the relevant mapping index to the number of objects to be mapped (n).

Example) RPDO: Index 0x1600, Subindex 0 = n
 TPDO: Index 0x1A00, Subindex 0 = n

- (5) Enable the PDO by changing the bit 31 of the relevant COB-ID entry to "0".

Example) RPDO: Index 0x1400, Subindex 1, Bit31 = 0
 TPDO: Index 0x1800, Subindex 1, Bit31 = 0

9.2.6 SDO protocol

[1] About SDO

The SDO (Service Data Object) protocol is used to set and adjust the inverter. SDO enables to access all objects (parameters) of the inverter. The CANopen communication of inverter supports a single Server SDO.

 For information about how to transmit data in SDO, refer to the manual of the master or configuration tool.

 For information about the objects, refer to “9.2.8 Object list”.

[2] Response on SDO error

If the access in SDO has an error, this communication card returns an Abort code listed in Table 9.2-13.

Table 9.2-13 Abort Codes on SDO Access Error

Abort codes	Description
0503 0000	Error on divided SDO transmission: Improper toggle bit
0504 0000	Response timeout error
0601 0000	Unsupported access to an object
0601 0001	Write only object is read
0601 0002	Read only object is written
0602 0000	Parameter does not exist
0604 0041	Object cannot be mapped to the PDO.
0604 0042	The number and length of the objects to be mapped would exceed PDO length.
0606 0000	Writing while EEPROM is running of inverter
0607 0010	Different parameter's data type
0607 0012	Data type does not match, length of service parameter too high.
0607 0013	Data type does not match, length of service parameter too low.
0609 0011	Accessed to the object without subindex
0609 0030	The value written is out of range
0609 0031	Value of parameter written too high.
0609 0032	Value of parameter written too low.
0800 0021	Inverter function code write error (SO1, SO5, and SO6 are written by CANopen when the link to RS-485 communication port is valid)
0800 0022	Write to inverter function code is disabled (running, writing, digital input terminal is ON)

9.2.7 Other services

(1) Network management (NMT)

Controls the DS 301 state machine. The Table 9.2-14 lists the behavior upon reception of each service.

Table 9.2-14 Behavior Upon reception of NMT Services

Services	Behavior on reception	Remarks
Start_Remote_Node	Enters into Operational state	PDO communication is valid only in Operational state.
Stop_Remote_Node	Enters into the Stop state.	Only the NMT service is available in the Stop state.
Enter_Pre-Operational	Enters into Pre-Operational state.	PDO communication is unavailable in the Pre-Operational state.
Reset_Communication		
Reset_Node	Same as the power restart	Reflects the node ID, y25 to y32/ o40 to o51 in the operation.

 For more information on NMT, refer to the master’s user’s manual or CANopen specifications DS 301 issued by CiA.

(2) Heartbeat and Node Guarding

A service for the disconnect detection. We recommend you to use either one.

 For information about Heartbeat and Node Guarding, refer to “9.2.11 Heartbeat and Node Guarding”.

⚠ CAUTION
Important: Either Heartbeat or Node Guarding is recommended
The setting for detecting disconnection in the CANopen device is invalid by default. Unless the setting is enabled, the CANopen network including inverter cannot detect a disconnection even if the disconnection occurs. We strongly recommend to enable the setting.

(3) Emergency (EMCY)

This service enables the inverter to automatically transmit the alarm occurred in the inverter. The format of the transmission data is as follows:

COB-ID	Byte0	Byte1	Byte2	Byte3	Byte4	Byte5	Byte6	Byte7
0x80 + node ID	Error field (L byte) (H byte)		Error register	0	0	0	0	0

Error field: Indicates the contents of alarm.
 Error register: 1: alarm occurring, 0: no alarm. (same as Index 1001.)

 For more information on the alarm code, refer to “9.2.13 Alarm code list”.

9.2.8 Object list

This chapter describes the objects (parameters) supported by the CANopen communication of inverter. The objects are classified into three types of areas.

(1) Communication profile area (Indexes: 1000 to 1A02)

The objects common to all devices for the CANopen communication. This area is defined in the CANopen specifications DS 301.

(2) Manufacturer specific profile area (Indexes: 2200 to 5F2A)

The objects only for our company. It is possible to access the inverter function codes, for example. Since they are dedicated objects, they are not compatible with CANopen devices provided by other manufacturer.

(3) Standard device profile area (Indexes: 6000 to 6078)

The objects for controlling the inverter. This area is standardized in the CANopen specifications DSP 402 and is compatible with the devices provided by other companies.

[1] Objects in the communication profile area

Table 9.2-15 lists the objects in the communication profile area. In the access field, R represents read only, RW represents readable & writable. In the data hold field, "Y" represents that the written data is held after the power OFF.

Table 9.2-15 Objects in the Communication Profile Area

Index (Hex)	Sub	Name	Description	Data type	Data hold	Access
1000	-	Device type	Fixed at 0x10192	UNSIGNED32	-	R
1001	-	Error register	1: Error, 0: No error	UNSIGNED8	-	R
1003	-	Pre-defined error field		ARRAY	-	-
	0	Number of errors	Number of errors occurred 1: one error, 0: no error	UNSIGNED8	-	R
	1	Standard error field	Displays the code of the occurring error (For details, refer to the Table 9.2-22)	UNSIGNED32	-	R
1005	-	COB-ID SYNC	COB-ID of the SYNC message Default value: 0x080	UNSIGNED32	Y	RW
1008	-	Manufacturer device name	Device name: Built-in CAN: "FRN-E2-COP" Option CAN: "OPC-E2-COP" (ASCII) fixed	STRING	-	R
1009	-	Manufacturer HW version	Hardware version: "SP0146" (ASCII) Control PCB No. for E2S	STRING	-	R
1010	-	Store parameter settings		ARRAY	-	-
	0	Number of entries	Number of subindexes	UNSIGNED8	-	R
	1	Store all parameters	Save All Parameter	UNSIGNED32	-	RW
	2	Store communication parameters	Save communication parameters (Object 1000h to 1A02h)	UNSIGNED32	-	RW
	3	Store application parameters	Save application parameters (Object 6000h to 6078h)	UNSIGNED32	-	RW
1011	-	Restore parameters		ARRAY	-	-
	0	Number of entries	Number of subindexes	UNSIGNED8	-	R
	1	Restore default values to all Parameters	Restore all default parameters same as H03=1 (*3)	UNSIGNED32	-	RW
	2	Restore default values to communication parameters	Communication parameters are initialized to the factory default values. (Object 1000h to 1A02h)	UNSIGNED32	-	RW
	3	Restore application parameters	Application parameters are initialized to the factory default values. (Object 6000h to 6078h)	UNSIGNED32	-	RW

9.2 CANopen Communication

Index (Hex)	Sub	Name	Description	Data type	Data hold	Access
100A	-	Manufacturer SW version	Software version: "E2S1-" + code M25 (same as the inverter ROM Version)	STRING	-	R
100C	-	Guard time	Guarding receive cycle setting (ms) Default value: 0 (no operation)	UNSIGNED16	Y	RW
100D	-	Life time factor	Guarding time coefficient Default value: 0 (no operation)	UNSIGNED8	Y	RW
1014	-	COB-ID EMCY	COB-ID of the EMCY message Read value: 0x0080 + node ID	UNSIGNED32	-	R
1016	-	Consumer heartbeat time		ARRAY	-	-
	0	Number of entries	Number of configurations	UNSIGNED8	-	R
	1	Consumer heartbeat time	Upper word: Node ID to be monitored Lower word: Heartbeat monitoring cycle Default value: 0 (no operation)	UNSIGNED32	Y	RW
1017	-	Producer heartbeat time	Transmission cycle of Heartbeat message Default value: 0 (no operation)	UNSIGNED16	Y	RW
1018	-	Identity Object		RECORD	-	-
	0	Number of entries	Number of subindexes: 1	UNSIGNED8	-	R
	1	Vendor ID	0x0000025E (Fuji Electric Group)	UNSIGNED32	-	R
1029	-	Error behavior		ARRAY	-	-
	0	Number of entries	Highest sub-index supported	UNSIGNED8	-	R
	1	Communication error	Default value: 0 (change to pre-operational) (For details, refer to the Table 9.2-21)	UNSIGNED8	-	RW
1200	-	Server SDO parameter		RECORD	-	-
	1	COB-ID C->S (rx)	0x600 + node ID.	UNSIGNED32	-	R
	2	COB-ID S->C (tx)	0x580 + node ID.	UNSIGNED32	-	R
1400	-	1st Receive PDO Communication Parameter		RECORD	-	-
	0	Number of entries	Number of subindexes: 2	UNSIGNED8	-	R
	1	COB-ID	COB-ID of RPDO No.1 Default value: 0x200 + node ID	UNSIGNED32	Y	RW ^{*1}
	2	Transmission type	Select the transmission type Default value: 255 (Change of state event) (refer to Table 9.2-9, Table 9.2-10)	UNSIGNED8	Y	RW
1401	-	2nd Receive PDO Communication Parameter		RECORD	-	-
	0	Number of entries	Number of subindexes: 2	UNSIGNED8	-	R
	1	COB-ID	COB-ID of RPDO No.2 Default value: 0x300 + node ID	UNSIGNED32	Y	RW ^{*1}
	2	Transmission type	Select the transmission type Default value: 255 (Change of state event) (refer to Table 9.2-9, Table 9.2-10)	UNSIGNED8	Y	RW
1402	-	3rd Receive PDO Communication Parameter		RECORD	-	-
	0	Number of entries	Number of subindexes: 2	UNSIGNED8	-	R
	1	COB-ID	COB-ID of RPDO No.3 Default value: 0x400 + node ID	UNSIGNED32	Y	RW ^{*1}
	2	Transmission type	Select the transmission type Default value: 255 (Change of state event) (refer to Table 9.2-9, Table 9.2-10)	UNSIGNED8	Y	RW

Index (Hex)	Sub	Name	Description	Data type	Data hold	Access
1600	-	1st Receive PDO Mapping Parameter		RECORD	-	-
	0	Number of mapped objects	Number of mapped objects (up to 4) Default value: 1	UNSIGNED8	-	RW
	1	PDO mapping entry1	Default value: 0x60400010 (Controlword)	UNSIGNED32	-	RW
	2	PDO mapping entry2	Default value: No mapping	UNSIGNED32	-	RW
	3	PDO mapping entry3	Default value: No mapping	UNSIGNED32	-	RW
	4	PDO mapping entry4	Default value: No mapping	UNSIGNED32	-	RW
1601	-	2nd Receive PDO Mapping Parameter		RECORD	-	-
	0	Number of mapped objects	Number of mapped objects (up to 4) Default value: 2	UNSIGNED8	-	RW
	1	PDO mapping entry1	Default value: 0x60400010 (Controlword)	UNSIGNED32	-	RW
	2	PDO mapping entry2	Default value: 0x60420010 (vl target velocity)	UNSIGNED32	-	RW
	3	PDO mapping entry3	Default value: No mapping	UNSIGNED32	-	RW
	4	PDO mapping entry4	Default value: No mapping	UNSIGNED32	-	RW
1602	-	3rd Receive PDO Mapping Parameter		RECORD	-	-
	0	Number of mapped objects	Number of mapped objects: 4	UNSIGNED8	-	R
	1	PDO mapping entry1	Fixed value: 0x5F020110 (writing function code mapping 1)	UNSIGNED32	-	R
	2	PDO mapping entry2	Fixed value: 0x5F020210 (writing function code mapping 2)	UNSIGNED32	-	R
	3	PDO mapping entry3	Fixed value: 0x5F020310 (writing function code mapping 3)	UNSIGNED32	-	R
	4	PDO mapping entry4	Fixed value: 0x5F020410 (writing function code mapping 4)	UNSIGNED32	-	R
1800	-	1st Transmit PDO Communication Parameter		RECORD	-	-
	0	Largest sub-index	Maximum sub-index No.: 5	UNSIGNED8	-	R
	1	COB-ID	COB-ID of TPDO No.1 Default value: 0x180 + node ID	UNSIGNED32	Y	RW ^{*1}
	2	Transmission type	Select the transmission type Default value: 255 (Change of state event) (refer to Table 9.2-11, Table 9.2-12)	UNSIGNED8	Y	RW
	3	Inhibit time	Waiting time for transmission (unit: 0.1 ms) Default value: 100 (10.0 ms)	UNSIGNED16	Y	RW ^{*2}
	5	Event timer	Periodical transmission interval (unit: 1 ms) Transmission type Valid at the time of 254 or 255. Default value: 0 (not used)	UNSIGNED16	Y	RW
1801	-	2nd Transmit PDO Communication Parameter		RECORD	-	-
	0	Largest sub-index	Maximum sub-index No.: 5	UNSIGNED8	-	R
	1	COB-ID	COB-ID of TPDO No.2 Default value: 0x280 + node ID	UNSIGNED32	Y	RW ^{*1}
	2	Transmission type	Select the transmission type Default value: 255 (Change of state event) (refer to Table 9.2-11, Table 9.2-12)	UNSIGNED8	Y	RW
	3	Inhibit time	Waiting time for transmission (unit: 0.1 ms) Default value: 100 (10.0 ms)	UNSIGNED16	Y	RW ^{*2}
	5	Event timer	Periodical transmission interval (unit: 1 ms) Transmission type Valid at the time of 254 or 255. Default value: 0 (not used)	UNSIGNED16	Y	RW

Index (Hex)	Sub	Name	Description	Data type	Data hold	Access
1802	-	3rd Transmit PDO Communication Parameter		RECORD	-	-
	0	Largest sub-index	Maximum sub-index No.: 5	UNSIGNED8	-	R
	1	COB-ID	COB-ID of TPDO No.3 Default value: 0x380 + node ID	UNSIGNED32	Y	RW ^{*1}
	2	Transmission type	Select the transmission type Default value: 255 (Change of state event) (refer to Table 9.2-11, Table 9.2-12)	UNSIGNED8	Y	RW
	3	Inhibit time	Waiting time for transmission (unit: 0.1 ms) Default value: 100 (10.0 ms)	UNSIGNED16	Y	RW ^{*2}
	5	Event timer	Periodical transmission interval (unit: 1 ms) Transmission type Valid at the time of 254 or 255. Default value: 0 (not used)	UNSIGNED16	Y	RW
1A00	-	1st Transmit PDO Mapping Parameter		RECORD	-	-
	0	Number of mapped objects	Number of mapped objects (up to 4) Default value: 1	UNSIGNED8	-	RW
	1	PDO mapping entry1	Default value: 0x60410010 (Statusword)	UNSIGNED32	-	RW
	2	PDO mapping entry2	Default value: No mapping	UNSIGNED8	-	RW
	3	PDO mapping entry3	Default value: No mapping	UNSIGNED8	-	RW
	4	PDO mapping entry4	Default value: No mapping	UNSIGNED32	-	RW
1A01	-	2nd Transmit PDO Mapping Parameter		RECORD	-	-
	0	Number of mapped objects	Number of mapped objects (up to 4) Default value: 2	UNSIGNED8	-	RW
	1	PDO mapping entry1	Default value: 0x60410010 (Statusword)	UNSIGNED32	-	RW
	2	PDO mapping entry2	Default value: 0x60440010 (vl control effort)	UNSIGNED32	-	RW
	3	PDO mapping entry3	Default value: No mapping	UNSIGNED8	-	RW
	4	PDO mapping entry4	Default value: No mapping	UNSIGNED32	-	RW
1A02	-	3rd Transmit PDO Mapping Parameter		RECORD	-	-
	0	Number of mapped objects	Number of mapped objects: 4	UNSIGNED8	-	R
	1	PDO mapping entry1	Fixed value: 0x5F030110 (reading function code mapping 1)	UNSIGNED32	-	R
	2	PDO mapping entry2	Fixed value: 0x5F030210 (reading function code mapping 2)	UNSIGNED32	-	R
	3	PDO mapping entry3	Fixed value: 0x5F030310 (reading function code mapping 3)	UNSIGNED32	-	R
	4	PDO mapping entry4	Fixed value: 0x5F030410 (reading function code mapping 4)	UNSIGNED32	-	R

*1: The change of COB-ID will be possible after writing one into the bit 31.

*2: The change of Inhibit timer is possible when the related PDO is invalid (COB-ID's bit 31 is one).



*3: Because CAN communication setting is also initialized, communication may be not possible after execution. For CAN communication execution, may be necessary to set again the related function codes of the drive (refer to Section 9.2.3).

■ 1010 / 1011 : Store / Restore

It is possible to be performed “Store” or “Restore” when the following conditions are satisfied.

- 1) The inverter is in a stopped state (Gate-off state).
- 2) The NMT state is in [Pre-operational] stage.

(1) Access

“Store” and “Restore” can be performed by writing the signature shown in the following table to each sub-index.

Index (HEX)	sub	Description	Signature
1010	1	Store all parameters	“save” (ISO8859/ character) MSB LSB 65h 76h 61h 73h
	2	Store communication parameters	
	3	Store application parameters	
1011	1	Restore default values to all Parameters	“load” (ISO8859/ character) MSB LSB 64h 61h 6Fh 6Ch
	2	Restore default values to communication parameters	
	3	Restore application parameters	

(2) Communication parameters area

No	Index (HEX)	Sub	Name	Remarks
1	1005	0	COB-ID SYNC	SYN-ID
2	100C	0	Guard time	Guarding error control
3	100D	0	Life time factor	
4	1016	1	Consumer Heartbeat time1	
5	1017	0	Producer Heartbeat time	Heartbeat error control(producer)
6	1029	1	Error beahavior	Communication error
7	1400	1	COB-ID	1st Receive PDO Communication Parameter
8		2	Transmission Type	
9	1401	1	COB-ID	2nd Receive PDO Communication Parameter
10		2	Transmission Type	
11	1402	1	COB-ID	3rd Receive PDO Communication Parameter
12		2	Transmission Type	
13	1600	0	1st RPDO Number of mapped objects	1st Receive PDO Mapping Parameter
14		1	PDO mapping entry1	
15		2	PDO mapping entry2	
16		3	PDO mapping entry3	
17		4	PDO mapping entry3	
18	1601	0	2nd RPDO Number of mapped objects	2nd Receive PDO Mapping Parameter
19		1	PDO mapping entry1	
20		2	PDO mapping entry2	
21		3	PDO mapping entry3	
22		4	PDO mapping entry3	
23	1800	1	1st TPDO COB-ID	1st Transmit PDO Communication Parameter
24		2	Transmission Type	
25		3	Inhibit Time	
26		5	Event Timer	
27	1801	1	2nd TPDO COB-ID	2nd Transmit PDO Communication Parameter
28		2	Transmission Type	
29		3	Inhibit Time	
30		5	Event Timer	

No	Index (HEX)	Sub	Name	Remarks
31	1802	1	3rd TPDO COB-ID	3rd Transmit PDO Communication Parameter
32		2	Transmission Type	
33		3	Inhibit Time	
34		5	Event Timer	
35	1A00	0	1st TPDO Number of mapped objects	1st Transmit PDO Mapping Parameter
36		1	PDO mapping entry1	
37		2	PDO mapping entry2	
38		3	PDO mapping entry3	
39		4	PDO mapping entry4	
40	1A01	0	2nd TPDO Number of mapped objects	2nd Transmit PDO Mapping Parameter
41		1	PDO mapping entry1	
42		2	PDO mapping entry2	
43		3	PDO mapping entry3	
44		4	PDO mapping entry4	

(3) Application parameters

No	Index (HEX)	Sub	Name	Remarks
1	6007	0	Communication abort behavior	Same as [y36]
2	6042	0	vl target velocity	
3	6046	1	vl velocity min amount	F16 (*1)
4	6046	2	vl velocity max amount	F03/A01 (*1)
5	6048	1	vl velocity acceleration Delta speed	Acceleration Time 1 [F07] (*1)
6		2	Delta time	
7	6049	1	vl velocity deceleration Delta speed	Deceleration Time 1 [F08] (*1)
8		2	Delta time	
9	604A	1	vl velocity quick stop Delta speed	Deceleration time for Forced stop[H56] (*1)
10		2	Delta time	
11	604B	1	vl set-point factor numerator	[C89] (*1)
12	604B	2	vl set-point factor denominator	[C90] (*1)
13	604D	0	vl pole number	[P01/A15] (*1)

*1: It changes automatically if the applicable function code is changed due to other causes such as the keypad.
It is automatically written to the applicable function code.

In this case, whether it is saved in the non-volatile memory depends on the set value of the function code [y97].

[y97=0] The data is saved in non-volatile memory. Even if the power is cut off, data is stored.

[y97=1] The data is saved in volatile memory. If the power is cut off, data is lost.

If "Store" is requested by Sub02 of the object 1010, it is also saved even with [y97 = 1].

[2] Objects in the profile area specific to Fuji Electric

Table 9.2-16 lists the objects in the profile area specific to Fuji Electric. In the access field, R represents read only, RW represents readable & writable. In the data hold field, “Y” represents that the written data is held after the power OFF.

Table 9.2-16 Objects in the Profile Area Specific to Fuji Electric

Index (Hex)	Sub	Name	Description	Data type	Data hold	Access
2200	0	Bus state	CAN communication state 0: Normal 1: Bus off/error passive 2: Other error	UNSIGNED8	-	R
3000	0	Node state	CANopen communication state 0: CAN not connected 1: Initializing 2: Stopped 3: Pre-Operational 4: Operational	UNSIGNED8	-	R
5E00 *2	-	Assignment of RPDO No.3		ARRAY	-	-
	0	Number of entries	Number of configurations: 4	UNSIGNED8	-	R
	1	Function code1	(writing function code mapping 1 for PDO No.3) Default value: Setting value of y25 / o40	UNSIGNED16	-	RW
	2	Function code2	(writing function code mapping 2 for PDO No.3) Default value: Setting value of y26 / o41	UNSIGNED16	-	RW
	3	Function code3	(writing function code mapping 3 for PDO No.3) Default value: Setting value of y27 / o42	UNSIGNED16	-	RW
5E01 *2	4	Function code4	(writing function code mapping 4 for PDO No.3) Default value: Setting value of y28 / o43	UNSIGNED16	-	RW
	-	Assignment of TPDO No.3		ARRAY	-	-
	0	Number of entries	Number of configurations: 4	UNSIGNED8	-	R
	1	Function code1	(reading function code mapping 1 for PDO No.3) Default value: Setting value of y29 / o48	UNSIGNED16	-	-
	2	Function code2	(reading function code mapping 2 for PDO No.3) Default value: Setting value of y30 / o49	UNSIGNED16	-	RW
5F02 to 5F2A *3	1 to 64	FRENIC's function code	Inverter function code access [How to specify function code] Index=5F□□, Sub=xx □□: type (Table 9.2-8) xx: number + 1 Example: E01 → Index 5F05, Sub 02	UNSIGNED16	Y	RW ^{*1}

*1: Writable only in Pre-Operational state.

*2: For information on how to specify the function code, refer to “9.2.5 [2] Receive PDO (from master to inverter)”, “(4) How to set the inverter function codes y25 to y32/o40 to o43, o48 to o51 and Indexes 5E00, 5E01”.



If the function code mapping is changed by the Indexes 5E00, 5E01, the change becomes effective in the inverter immediately. If the inverter is restarted or the ResetNode service is received, the mapping with y25 to y32 / o40 to o43 and o48 to o51 becomes effective.

*3: For information on the function code type, refer to “9.2.5 [2] (4) How to set the inverter function codes y25 to y32/o40 to o43, o48 to o51 and Indexes 5E00, 5E01”. For information about data format of the inverter function codes, refer to RS-485 Communication User’s Manual, Chapter 5, “5.2 Data Format”.

*4: The inverter function codes S01, S05, S06, S07, S12, S13, and S19 are cleared after the power OFF.

9.2.9 Standard device profile area

Table 9.2-17 lists the objects in the standard device profile area specific. In the access field, R represents read only, W represents write only, and RW represents readable & writable. In the data hold field, O represents that the written data is held after the power OFF.

Table 9.2-17 Objects in Standard Device Profile Area

Index (Hex)	Sub	Name	Description	Data type	Data hold	Access
6007	-	Communication abort behavior (Same as y36)			-	RW
603F	-	Error code	Alarm history (latest) (For details, refer to the Table 9.2-22)	UNSIGNED16	-	R
6040	-	Controlword	Operation control (DS 402 state machine control)	UNSIGNED16	-	RW
6041	-	Statusword	Status monitor (display the DS 402 state machine status)	UNSIGNED16	-	R
6042	-	vl target velocity	Speed command (r/min)	INTEGER16	-	RW
6043	-	vl velocity demand	Monitor the output speed (r/min)	INTEGER16	-	R
6044	-	vl control effort	ditto	INTEGER16	-	R
6046	-	vl velocity min max amount		ARRAY	-	-
	0	Number of entries	Number of subindexes: 2	UNSIGNED8	-	R
	1	vl velocity min amount	Lower limit speed (r/min) (corresponding to the inverter function code F16)	UNSIGNED32	Y	RW
	2	vl velocity max amount	Maximum speed (r/min) (corresponding to the inverter function codes F03/A01 *1)	UNSIGNED32	Y	RW
6048	-	vl velocity acceleration (Delta speed/Delta time sets the acceleration. It corresponds to the inverter function code S08)		RECORD	-	-
	0	Number of entries	Number of subindexes: 2	UNSIGNED8	-	R
	1	Delta speed	Speed increment (r/min) for Delta time	UNSIGNED32	Y *2	RW
	2	Delta time	Time (s)	UNSIGNED16	Y *2	RW
6049	-	vl velocity deceleration (Delta speed/Delta time sets the deceleration. It corresponds to the inverter function code S09)		RECORD	-	-
	0	Number of entries	Number of subindexes: 2	UNSIGNED8	-	R
	1	Delta speed	Delta time sets the deceleration (r/min)	UNSIGNED32	Y *2	RW
	2	Delta time	Time (s)	UNSIGNED16	Y *2	RW
604A	-	vl velocity quick stop (Delta speed/Delta time sets the deceleration. It corresponds to the inverter function code H56)		RECORD	-	-
	0	Number of entries	Number of subindexes: 2	UNSIGNED8	-	R
	1	Delta speed	Delta time sets the deceleration (r/min)	UNSIGNED32	Y *2	RW
	2	Delta time	Time (s)	UNSIGNED16	Y *2	RW
604B	-	vl set-point factor	Changes the resolution and range for the speed setting	ARRAY	-	-
	0	Highest sub-index supported	Number of subindexes: 2	INTEGER16	-	R
	1	Numerator	-32768 to +32767 (Except for 0; treated as "1" when the setting is made.)	INTEGER16	-	RW
	2	Denominator		INTEGER16	-	RW
604D	-	vl pole number	Number of motor poles (corresponds to the inverter function codes P01/A15 *1)	UNSIGNED8	Y	RW
6060	-	Modes of operation	Select the DS 402's mode	INTEGER8	-	W
6061	-	Modes of operation display	Selected state of the DS 402's mode Always fixed at 2=Velocity mode	INTEGER8	-	R
6077	-	Torque actual value	Actual value of instantaneous torque	INTEGER16	-	R
6078	-	Current actual value	Actual value of output current	INTEGER16	-	R

*1: The corresponding inverter function code automatically changes according to the motor's selected state.



For information about mode selection, refer to Chapter 5 "5.3.6 A codes (Motor 2 parameters)".

*2: If the power is turned OFF, the acceleration and deceleration slope values are held.

9.2.10 Inverter operation in CANopen communication

This chapter describes the inverter’s operation by using the CANopen communication. There are the following two ways to run the inverter:

1. Operation according to CANopen’s drive profile (DSP 402)
2. Operation according to the inverter function code S06

[1] Operation according to CANopen’s drive profile (DSP 402)

(1) Related object list

Index (Hex)	Sub	Name	Description	Data type	Access
6040	-	Controlword	Controls the state change of state machine	UNSIGNED16	RW
6041	-	Statusword	Displays the current state.	UNSIGNED16	R
6042	-	vl target velocity	Speed command (r/min)	INTEGER16	RW
6044	-	vl control effort	Monitor the output speed (r/min)	INTEGER16	R
604B	-	vl set-point factor	Modifies the resolution and specified range of the speed settings.	ARRAY	RW

 **Tip** As for the inverter’s operation, PDO No.2 is useful which can send both Controlword and speed command at the same time.

(2) Description of related objects

■ Controlword

bit7	bit6	bit5	bit4	bit3	bit2	bit1	bit0
Fault reset	0	0	0	Enable operation	Quick stop	Enable voltage	Switch on
bit15	bit14	bit13	bit12	bit11	bit10	bit9	bit8
X4	X3	X2	X1	Reverse	0	0	Halt

- bits 0 to 3 : Operates the state change of state machine. Refer to Figure 9.2-3.
- bit 7 Fault reset : Resets the alarm by change from zero to one.
- bit 8 Halt : 1= Fixes the inverter’s output speed at 0 r/min.
- bit 11 Reverse : Sets the rotation direction. 0= rotates forward, 1=rotates backward
- bits 12 to 15 : Digital input terminal X1 to X4. 0=OFF, 1=ON

■ Statusword

bit7	bit6	bit5	bit4	bit3	bit2	bit1	bit0
Warning	Switch on disabled	Quick stop	Voltage enabled	Fault	Operation enabled	Switched On	Ready to switch on
bit15	bit14	bit13	bit12	bit11	bit10	bit9	bit8
Direction of rotation	0	0	0	Internal limit active	Target reached	Remote	0

bits 0 to 2, 5, 6 : Displays the state machine status. Refer to Figure 9.2-3.

bit 3 Fault : 1= Tripping

bit 4 Voltage enabled : 1= Main circuit ON

bit 7 Warning : Not used. Fixed at 0.

bit 9 Remote : 1= Either speed or operation command is enabled through CANopen.

bit 10 Target reached : 1= Reached to preset speed.

bit 11 Internal limit active : 1= The torque, voltage, or current limit is limited.

bit 15 Direction of rotation : 0= Normal rotation or stop, 1= Reverse rotation

■ vl target velocity

Issues a speed command expressed in r/min. Valid range: -32768 r/min to 32767 r/min

■ vl control effort

Displays the current output speed expressed in r/min basis. Output range: -32768 r/min to 32767 r/min

(3) State Machine

To run the inverter, operate the state machine (state transition diagram) defined with DSP 402. The state of the state machine is changed by Controlword (CTW in the figure) and the state is monitored by Statusword (STW in the figure). The Figure 9.2-3 shows the state machine and the Table 9.2-18 shows the commands to the inverter during each state transition.

Tip The inverter enters into running state by putting the state machine in the state 5 “Operation enabled” in the Table 9.2-18.

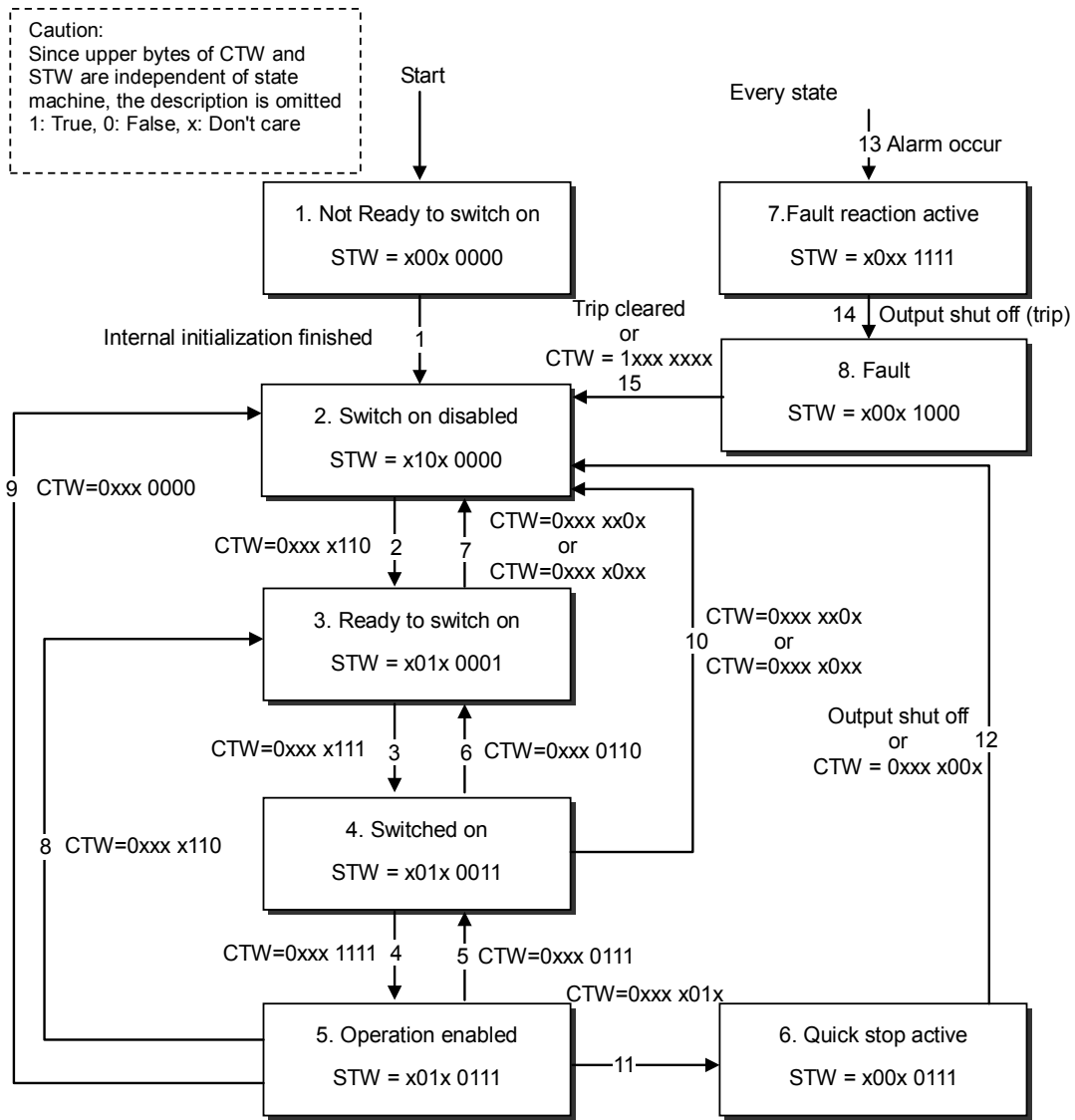

Figure 9.2-3 State Machine

Table 9.2-18 Correspondence of the States of State Machine and Inverter

State No.	Name	State of inverter
1	Not Ready to switch on	Initializing the CANopen
2	Switch on disabled	Inverter's alarm cleared
3	Ready to switch on	Inverter output shut off
4	Switched on	Inverter stopped (running command OFF)
5	Operation enabled	Inverter running (running command ON)
6	Quick stop active	Inverter stopped urgently (for the time set in Index 604A)
7	Fault reaction active	Alarm detected
8	Fault	Inverter tripping

(4) Communication example

This section describes the communication example when running the inverter by controlling the DSP 402 state machine. In the description, PDO No.2 is used. Besides, the following conditions are assumed:

- Node ID of inverter (inverter function code y21 / o31 of this communication card) =1
- Transmit PDO Nos. 1 and 3 are invalid.
That is, Index 1800 sub1=0x80000181, Index 1802 sub1=0x80000381
- Other CANopen's objects are set to default
- Inverter function code y98 =3

The format of PDO No.2 is as follows:

■ **Receive PDO (from master to inverter)**

COB-ID	Byte0	Byte1	Byte2	Byte3
0x301	Controlword (L byte) (H byte)		vl_target_velocity (L byte) (H byte)	

■ **Transmit PDO (from inverter to master)**

COB-ID	Byte0	Byte1	Byte2	Byte3
0x281	Statusword (L byte) (H byte)		vl_control_effort (L byte) (H byte)	

- 1) If Start_Remote_Node service is received, the inverter moves to Operational state to enable the PDO communication. At the same time as the state changes, the transmit PDO No.2 responds as follows: The lower byte of Statusword (Byte0, 1) = 50 indicates that the state machine is in the state 2.

Transmit PDO (from inverter to master)	COB-ID	Byte0	Byte1	Byte2	Byte3
	0x281	50	02	00	00

- 2) Here, change the state from 2 to 3. Transmit the data below to Controlword (Byte0, 1).

Receive PDO (from master to inverter)	COB-ID	Byte0	Byte1	Byte2	Byte3
	0x301	06	00	00	00

As shown above, the transmit PDO responds as follows. The lower byte of Statusword (Byte0, 1) = 31 indicates that the state is 3.

Transmit PDO (from inverter to master)	COB-ID	Byte0	Byte1	Byte2	Byte3
	0x281	31	02	00	00

- 3) Next, change the state from 3 to 4. Transmit the data below to Controlword (Byte0, 1).

Receive PDO (from master to inverter)	COB-ID	Byte0	Byte1	Byte2	Byte3
	0x301	07	00	00	00

As shown above, the transmit PDO responds as follows. The lower byte of Statusword (Byte0, 1) = 33 indicates that the state is 4.

Transmit PDO (from inverter to master)	COB-ID	Byte0	Byte1	Byte2	Byte3
	0x281	33	02	00	00

- 4) Issue the change of the state from 4 to 5 (normal rotation command) and a speed command. The speed command loaded into vl_target_velocity (Byte2, 3) is 1800 r/min (=0x0708).

Receive PDO (from master to inverter)	COB-ID	Byte0	Byte1	Byte2	Byte3
	0x301	0 F	00	08	07

Thus, the inverter enters into running state and starts to accelerate to 1800 r/min. The lower byte of Statusword (Byte0, 1) = 37 indicates that the state is 5. Also, since the value in the speed monitor vl_control_effort (Byte2, 3) changes during the acceleration, the inverter transmits the data below continuously until it reaches the speed.

Transmit PDO (from inverter to master)	COB-ID	Byte0	Byte1	Byte2	Byte3
	0x281	37	02	**	**

- 5) To stop the inverter, change the state from 5 to 4.

Receive PDO (from master to inverter)	COB-ID	Byte0	Byte1	Byte2	Byte3
	0x301	07	00	08	07

As shown above, the inverter decelerates. The lower byte of Statusword (Byte0, 1) = 33 indicates that the state is 4. Also, since the value in the speed monitor vl_control_effort (Byte2, 3) changes during the acceleration, the inverter transmits the data below continuously until it stops.

Transmit PDO (from inverter to master)	COB-ID	Byte0	Byte1	Byte2	Byte3
	0x281	33	02	**	**

[2] Operation according to the inverter function code S06

- Note** Important: In order to enable the running command with S06, it is necessary to meet all conditions below:
- Both receive PDO Nos. 1 and 2 are invalid.
That is, Index 1400 sub1=0x80000xxx, Index 1401 sub1=0x80000xxx
 - The DSP 402 state machine is in the state 2.
 - The inverter function code y98 = 2 or 3.

(1) Related object list

Index (Hex)	Sub	Name	Description	Data type	Access
5F02	07	Inverter function code S06	Running command (note)	UNSIGNED16	RW
5F03	0F	Inverter function code M14	Running status monitor	UNSIGNED16	R
5F02	06	Inverter function code S05	Frequency command (unit: 0.01 Hz)	INTEGER16	RW
5F03	0A	Inverter function code M09	Output frequency monitor (unit: 0.01 Hz)	INTEGER16	R

- Note** The inverter operation with S06 does not follow the DSP 402 state machine. Therefore, Statusword does not indicates the inverter’s status. Use M14.
- Tip** PDO No.3 is used for the operation with S06. For information about PDO No.3, refer to “9.2.5 PDO protocol”.

(2) Description of related object

■ Function code S06 only for the inverter communication

bit7	bit6	bit5	bit4	bit3	bit2	bit1	bit0
-	X5	X4	X3	X2	X1	REV	FWD
bit15	bit14	bit13	bit12	bit11	bit10	bit9	bit8
RST	XR	XF	0	0	0	0	0

- bit 0 FWD : 1= normal rotation command
- bit 1 REV : 1= reverse rotation command
- bits 2 to 10, X1 to X5 : Communication control input terminal (FRENIC-Ace supports X1 to X5)
- bits 13, 14, XF, XR : Communication control input terminal, XF (FWD) terminal, XR (REV) terminal
- bit 15 RST : Change value 0 to 1 for the bit to release the trip

■ **Function code M14 only for the inverter communication**

bit7	bit6	bit5	bit4	bit3	bit2	bit1	bit0
VL	TL	NUV	BRK	INT	EXT	REV	FWD
bit15	bit14	bit13	bit12	bit11	bit10	bit9	bit8
BUSY	0	0	RL	ALM	DEC	ACC	IL

- bit 0 FWD : 1= normal rotating
- bit 1 REV : 1= reverse rotating
- bit 2 EXT : 1= DC braking or pre-exciting
- bit 3 INT : 1= inverter shut off
- bit 4 BRK : 1= braking
- bit 5 NUV : 1= DC link established
- bit 6 TL : 1= torque limiting
- bit 7 VL : 1= voltage limiting
- bit 8 IL : 1= current limiting
- bit 9 ACC : 1= accelerating
- bit 10 DEC : 1= decelerating
- bit 11 ALM : 1= batch alarm
- bit 12 RL : 1= valid communication
- bit 15 BUSY : 1= function code writing

■ **Function code S05 only for the inverter communication**

Issue a frequency command expressed in 0.01 Hz basis.

Setting range: -327.68 Hz to 327.67 Hz

■ **Function code M09 only for the inverter communication**

Displays the current output frequency expressed in 0.01 Hz.

Output range: -327.68 Hz to 327.67 Hz

(3) Communication example

This section describes the communication example when running the inverter by using S06. In the description, PDO No.3 is used. Besides, the following conditions are assumed:

- Node ID of inverter (y21 o31 of this communication card) =1
- Mapping of PDO No.3

y25 / o40=0206 (write function code 1=S06)	y29 / o48=030E (read function code 1=M14)
y26 / o41=0205 (write function code 2=S05)	y30 / o49=0309 (read function code 2=M09)
y27 / o42=0000 (write function code 3=none)	y31 / o50=0000 (read function code 3=none)
y28 / o43=0000 (write function code 4=none)	y32 / o51=0000 (read function code 4=none)
- Receive PDO Nos. 1 and 2 are invalid.
That is, Index 1400 sub1=0x80000201, Index 1401 sub1=0x80000301
- Transmit PDO Nos. 1 and 2 are invalid.
That is, Index 1800 sub1=0x80000181, Index 1801 sub1=0x80000281
- Other CANopen's objects are set to default
- Inverter function code y98 =3

The format of PDO No.3 mapped above is as follows:

■ **Receive PDO (from master to inverter)**

COB-ID	Byte0	Byte1	Byte2	Byte3	Byte4	Byte5	Byte6	Byte7
0x401	S06 (L byte) (H byte)		S05 (L byte) (H byte)		Terminal command assigned Disable		Terminal command assigned Disable	

■ **Transmit PDO (from inverter to master)**

COB-ID	Byte0	Byte1	Byte2	Byte3	Byte4	Byte5	Byte6	Byte7
0x381	M14 (L byte) (H byte)		M09 (L byte) (H byte)		Terminal command assigned Disable		Terminal command assigned Disable	

- 1) If Start_Remote_Node service is received from, the inverter moves to Operational state (RUN LED lights up in green) to enable the PDO communication. At the same time as the state change, the transmit PDO No.3 responds as follows:

Transmit PDO (from inverter to master)	COB-ID	Byte0	Byte1	Byte2	Byte3	Bytes 4 to 7
	0x381	28	10	00	00	00000000

- 2) In this case, S06=1 (FWD=1) as a running command and S05=50.00 Hz (=0x1388) as a frequency command are transmitted.

Receive PDO (from master to inverter)	COB-ID	Byte0	Byte1	Byte2	Byte3	Bytes 4 to 7
	0x401	01	00	88	13	00000000

Thus, the inverter enters into a running state. The transmit PDO are as follows when the speed is reached:

Transmit PDO (from inverter to master)	COB-ID	Byte0	Byte1	Byte2	Byte3	Bytes 4 to 7
	0x381	21	10	88	13	00000000

- 3) To stop the inverter, transmit S06=0 (FWD=0).

Receive PDO (from master to inverter)	COB-ID	Byte0	Byte1	Byte2	Byte3	Bytes 4 to 7
	0x401	00	00	88	13	00000000

The FWD OFF command lets the inverter decelerate. After the stop, the transmit PDO responds as follows.

Transmit PDO (from inverter to master)	COB-ID	Byte0	Byte1	Byte2	Byte3	Bytes 4 to 7
	0x381	28	10	00	00	00000000

- 4) To run the inverter in reverse, transmit S06=2 (REV=1).

Receive PDO (from master to inverter)	COB-ID	Byte0	Byte1	Byte2	Byte3	Bytes 4 to 7
	0x401	02	00	88	13	00000000

Thus, the inverter enters into a reverse running state. The responses are as follows when the speed is reached:

Transmit PDO (from inverter to master)	COB-ID	Byte0	Byte1	Byte2	Byte3	Bytes 4 to 7
	0x381	22	10	88	13	00000000

9.2.11 Heartbeat and Node Guarding

The Heartbeat and Node Guarding services are provided for detecting disconnection. We recommend you to use either one.

⚠ CAUTION

Important: The use of either Heartbeat or Node Guarding is recommended

The setting for detecting disconnection in the CANopen device is invalid by default. Unless the setting is enabled, the CANopen network including inverter can not detect a disconnection even if the disconnection occurs. We strongly recommend to enable the setting.

[1] Heartbeat

Heartbeat is a mechanism to detect the disconnection in the CANopen network by monitoring the signals from the specified node.

 For more information about detailed behavior of Heartbeat, refer to the CANopen specifications DS 301.

 **Note** Do not use both Heartbeat and Node Guarding at the same time. If they are used at the same time, the disconnection is not detected properly. To use Heartbeat, make Node Guarding invalid, that is, set Index 100C=0 and Index 100D=0 (refer to Section 9.2.11 [2]).

(1) Related object list

Index (Hex)	Sub	Name	Description	Data type	Access
1016	-	Consumer heartbeat time		ARRAY	-
	0	Number of entries	Number of configurations: 1	UNSIGNED8	R
	1	Consumer heartbeat time	Upper word: Node ID to be monitored Lower word: Heartbeat monitoring time Default value: 0 (no operation)	UNSIGNED32	RW
1017	-	Producer heartbeat time	Transmission cycle of Heartbeat message Default value: 0 (no operation)	UNSIGNED16	RW

(2) Consumer heartbeat time

It is the preset time interval within the Heartbeat signals should be received from the specified node ID (Heartbeat producer). The behavior is as follows: if the Heartbeat signal can not be received over monitoring time, the disconnection is deemed to occur.

 For information on the behavior upon the CANopen disconnection, refer to “9.2.12 Behavior upon detection of CANopen network disconnection”.

Byte0	Byte1	Byte2	Byte3	Byte4	Byte5	Byte6	Byte7
0000		Node ID to be monitored		Heartbeat monitoring time (ms)			

(3) Producer Heartbeat time

Automatically transmits the Heartbeat signals continuously at the preset interval (on a 1 ms basis). Another node (Heartbeat consumer) monitors this Heartbeat signals.

[2] Node Guarding

Node Guarding is a mechanism to detect disconnections by monitoring the guarding signals periodically sent from the master.



For more information about detailed behavior of Node Guarding, refer to the CANopen specifications DS 301.



Note Do not use both Heartbeat and Node Guarding at the same time. If they are used at the same time, the disconnection is not detected properly. To use Node Guarding, make Heartbeat invalid, that is, set Index 1016=0 and Index 1017=0 (refer to Section 9.2.11 [1]).

(1) Related object list

Index (Hex)	Sub	Name	Description	Data type	Access
100C	-	Guard time	Guarding reception cycle setting (ms) Default value: 0 (no operation)	UNSIGNED16	RW
100D	-	Life time factor	Guarding time coefficient Default value: 0 (no operation)	UNSIGNED8	RW

(2) Guard time and Life time factor

Sets the receive interval of Guarding signals from the master. If the Guarding signal can not be received over preset receiving time, the disconnection is deemed to occur.

Set the receive interval in the equation below:

$$\text{Guarding receive interval (ms)} = \text{Guard time (ms)} \times \text{Life time factor}$$

Example: Guard time=100ms, Life time factor =5:

$$\text{Guarding receive interval (ms)} = 100 \text{ ms} \times 5 = 500 \text{ ms}$$



For information on the behavior upon the CANopen disconnection, refer to “9.2.12 Behavior upon detection of CANopen network disconnection”.

9.2.12 Behavior upon detection of CANopen network disconnection

The inverter function codes y34 / o27 y35 / o28 and y36 set up the behavior (Table 9.2-20) when the inverter detects the disconnection of the CANopen network.

CAN communications error might not occur depending on the combination of setting values.

[1] Related object and function code list

No	CANopen object Index (Hex)	Function code	Description
1	1029	--	Error behavior Setting the NMT state transition destination when a communication error occurs.
2	6007	y36	Communication abort option code. Setting the behavior when a communication error occurs.
3	--	y34/y35 o27/ o28	Error reaction. Setting the behavior when a communication error occurs.
4	--	H81	Assigned minor failure. Setting if it is treated as a minor failure when error occurs.

Note that the inverter determines under the conditions below that a disconnection occurred:

Case 1 : Consumer heartbeat or Node Guarding detect the disconnection.

Case 2 : The bus-off occurs in CAN

Case 3 : NMT state change (Operational -> Other state)

Table 9.2-19 Selection of Case 3 by y36

No	case1	case2	case3	6007h (y36)	Behavior at network disconnection
1	-	-	-	0	[no action] Ignoring the communications error.
2	error	error	-	1	[malfunction] Immediately coast to a stop and trip with $[E-r-t]$
	error	error	error	-1	
3	error	error	-	2	[Device control command 'Disable Voltage'] CTW=Disable voltage (no $[E-r-t]$ trip)
	error	error	error	-2	
4	error	error	-	3	[Device control command 'Quick Stop'] CTW=Quick stop (no $[E-r-t]$ trip)
	error	error	error	-3	
5	error	error	-	-4	[manufacturer specific] (Refer to Table 9.2-20)
	error	error	error	-5	



If Case 3 is effective and
Setting value of the object 1029 is other than "1", a communication error might occur.



For more information about Heartbeat consumer or Node Guarding, refer to "9.2.11 Heartbeat and Node Guarding".



If a disconnection occurs, the inverter switches to Pre-Operational and PDO becomes unavailable.

Table 9.2-20 Behavior Setting upon Detection of CANopen Network Disconnection (y36, y34/o27, y35/o28)

No	Function code			Outline of behavior
	y36 (Object 6007)	y34,y35 o27, o28	H81(bit14)	
1	0	Don't care	Don't care	[no action] Keep the current operation. (no $[E-r-t]$ trip) Ignoring the communications error.
2	1(-1)			[malfunction] Immediately coast to a stop and trip with $[E-r-t]$
3	2(-2)			[Device control command 'Disable Voltage'] CTW=Disable voltage (no $[E-r-t]$ trip)
4	3(-3)			[Device control command 'Quick Stop'] CTW=Quick stop (no $[E-r-t]$ trip)
5	-4 (-5)	1	0	After the time specified by [y35], coast to a stop and trip with $[E-r-t]$.
6		2		If the inverter receives any data within the time specified by [y35], ignore the communications error. After the timeout, coast to a stop and trip with $[E-r-t]$.
7		10		Immediately decelerate to a stop. Issue $[E-r-t]$ after stopping.
8		11		After the time specified by [y35], decelerate to a stop. Issue $[E-r-t]$ after stopping.
9		12		If the inverter receives any data within the time specified by [y35], ignore the communications error. After the timeout, decelerate to a stop and trip with $[E-r-t]$.
10		Other than above		Immediately coast to a stop and trip with $[E-r-t]$.
11		1		1
12	2	Same as above		
13	10	Same as above		
14	11	Same as above		
15	12	Same as above		
16	Other than above	Same as above		

Note If y36=-4 or y36=-5 and the object 1029 setting is other than "1", the speed and run command become ineffective before error processing.

Table 9.2-21 Object 1029 (error behavior) setting

No	Object 1029 sub 1	NMT state	Remarks
1	0	Pre-operational	(only if currently in NMT state Operational)
2	1	(no change)	No change of the NMT state
3	2	Stopped	The State Machine(*) and CTW are initialized. (*Figure 9.2-3 State Machine)

[2] Restart from CANopen network disconnection failure

Ordinary restart sequence from CANopen network disconnection failure is shown in Figure 9.2-4.

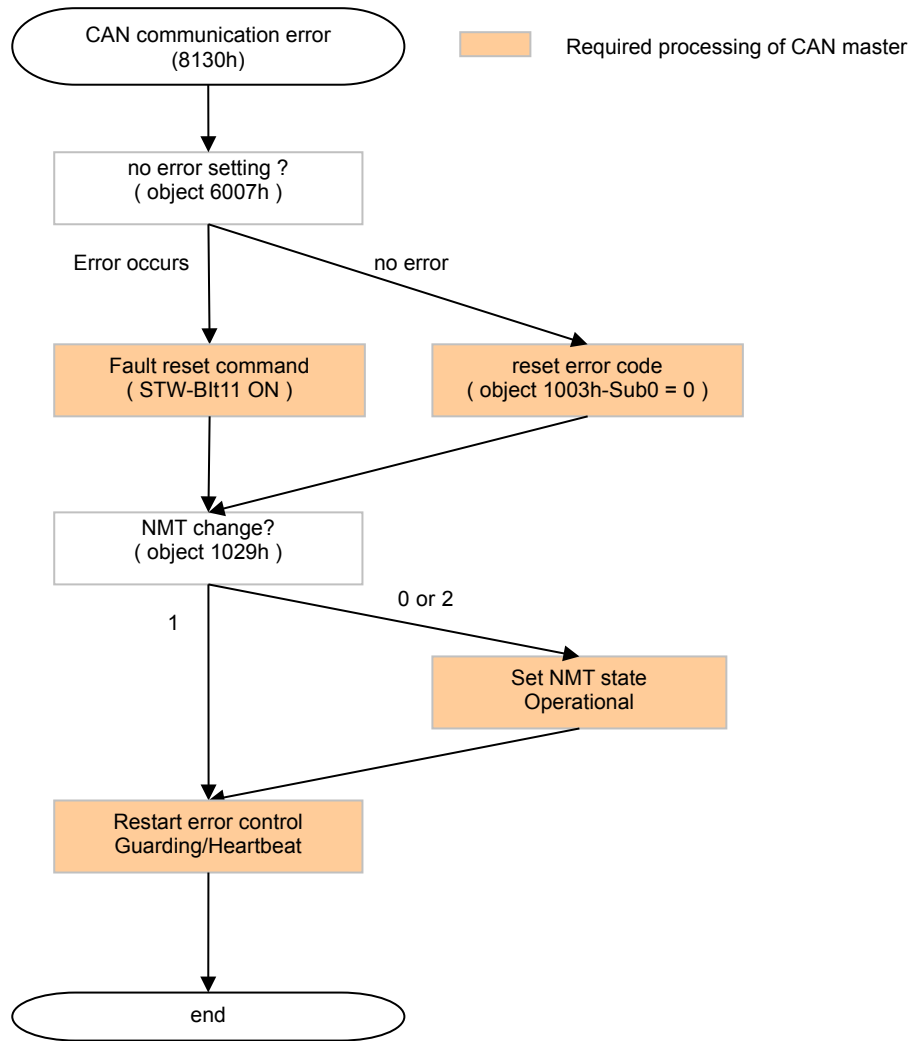

Figure 9.2-4 State Machine

9.2.13 Alarm code list

There are following two ways to read alarm codes via CANopen when the inverter trips.

1. Read the alarm code defined in CANopen from Index 1003 sub1 Standard error field or Index 603F Error code For reference: When an alarm on occurs, EMCY message is automatically sent to the CANopen master (see Section 9.2.7) and the alarm code is written into Index 1003 sub1 Standard error field and Index 603F Error code. However, since the EMCY message is not held, the message can not be read afterward.
2. Use the inverter function codes M16, M17, M18, and M19 to read the alarm codes (latest, first, second, and third most recent alarm codes)

The Table 9.2-22 lists the alarm codes:

Table 9.2-22 Alarm Code List

Alarm code		Content	Display	Alarm code		Content	Display
Error field	M16 to M19			Error field	M16 to M19		
0000	0 (00 _H)	No alarm	---	5220	33 (21 _H)	Terminal block PCB error	<i>E-3</i>
2310	1 (01 _H)	Over current (accelerating)	<i>OC1</i>	7510	34 (22 _H)	Option communications error	<i>E-4</i>
2310	2 (02 _H)	Over current (decelerating)	<i>OC2</i>	8100	35 (23 _H)	Option error	<i>E-5</i>
2310	3 (03 _H)	Over current (constant rate)	<i>OC3</i>	F004	36 (24 _H)	Operation error	<i>E-6</i>
2120	5 (05 _H)	Ground fault	<i>EF</i>	7200	37 (25 _H)	Tuning error	<i>E-7</i>
3210	6 (06 _H)	Over voltage (accelerating)	<i>OV1</i>	7510	38 (26 _H)	RS-485 communications error (COM port 1)	<i>E-8</i>
3210	7 (07 _H)	Over voltage (decelerating)	<i>OV2</i>	7120	42 (2A _H)	Step-out detection	<i>E-d</i>
3210	8 (08 _H)	Over voltage (constant speed or stopping)	<i>OV3</i>	3300	46 (2E _H)	Output phase-failure detection	<i>OPL</i>
3220	10 (0A _H)	Under voltage	<i>UV</i>	8400	47 (2F _H)	Speed inconsistency/ excessive speed deviation	<i>E-E</i>
3130	11 (0B _H)	Input phase loss	<i>LI n</i>	3221	51 (33 _H)	Data saving error during undervoltage	<i>E-F</i>
5450	14 (0E _H)	DC fuse-blowing	<i>FUS</i>	7510	53 (35 _H)	RS-485 communications error (COM port 2)	<i>E-P</i>
5440	16 (10 _H)	Charging circuit failure	<i>PbF</i>	5220	54 (36 _H)	Hardware error	<i>E-H</i>
4210	17 (11 _H)	Heat sink overheat	<i>OH1</i>	8500	56 (38 _H)	Positioning control error	<i>E-o</i>
9000	18 (12 _H)	External alarm	<i>OH2</i>	5430	57 (39 _H)	EN circuit failure	<i>ECF</i>
4210	19 (13 _H)	Inverter internal overheat	<i>OH3</i>	7200	58 (3A _H)	PID feedback wire break	<i>LoF</i>
4310	20 (14 _H)	Motor protection (PTC/NTC thermistor)	<i>OH4</i>	5400	59 (3B _H)	Braking transistor broken	<i>dbA</i>
4210	22 (16 _H)	Braking resistor overheat	<i>dbH</i>	6320	65 (41 _H)	Customizable logic failure	<i>ECL</i>
4310	23 (17 _H)	Overload of motor 1	<i>OL1</i>	4210	70 (46 _H)	Charging resistor overheat	<i>OH5</i>
4310	24 (18 _H)	Overload of motor 2	<i>OL2</i>	8110	---	CAN overrun	---
4110	25 (19 _H)	Inverter overload	<i>OLU</i>	8120	---	CAN in Error passive	---
FF00	254 (FE _H)	Mock alarm	<i>Err</i>	8130	---	Life guard error	---
8110	---	CAN overrun (Note)	---			HeartBeat error	---
8120	---	CAN error passive (Note)	---			Out of operational	---
8130	---	Guarding error or hard beat error (CANopen communication disconnect detection) (Note)	---	8140	---	Recovered from Bus-Off	---
8140	---	Recovery from CAN bus-off (Note)	---	8150	---	Transmit COB-ID	---
7310	27 (1B _H)	Overspeed protection	<i>OS</i>	8200	---	Protocol error	---
7301	28 (1C _H)	PG wire break	<i>PG</i>	8210	---	PDO not processed due to length error	---
5500	31 (1F _H)	Memory error	<i>E-1</i>	8220	---	PDO length exceeded	---
7520	32 (20 _H)	Keypad communications error	<i>E-2</i>				

Note: After this error occurred, the inverter generates *E-5* according to the y34 / o27 setting.

9.2.14 Other points to note

Here, lists the points to note when using the CANopen communication:

- (1) Avoid setting Transmission type 255 for the transmit PDO No. 2 and 3 at the same time (transmitted each time the data changes) and setting Inhibit time to zero. The CANopen communication traffic rises due to the frequency of the data change so that intended feature can not be met. Reduce either one of transmission frequency (set larger Inhibit time, use Sync signal, etc.)
- (2) The resolution of the timer is 2 ms. Consequently, if odd timer value is set for the object whose timer can be set, the value assumed is the next higher even value. For example, if the timer is set to 21 ms, the value is assumed to be 22 ms.
- (3) To cancel the auto-tuning (writing data into the inverter function code P04 and A18) over the CANopen communication, write zero into each inverter function code.
- (4) If the same object is mapped in the same RPDO, the information mapped later will be valid.

Example: If CTW is mapped in all mapping entries of RPDO1, only the last data is valid.

6040	6040	6040	6040
Invalid	Invalid	Invalid	Valid

- (5) Relationship between 6043 and 6044 in TPDO
 - The simultaneity of numeric value is not guaranteed in order to poll internal data.
 - Since 6043 is a request and 6044 is a feedback, in order to use the numeric value simply, it is recommended to map in order of 6043 and 6044.

9.2.15 Keypad LED operation monitor “3_40”

The status of CAN communication is displayed in the LED operation monitor item “3_40” in the keypad.

Display item	CANopen state	LED Display	Data
3_40	No-operation state (no operation is selected)	----	0
	“Stop” state	[STP]	1
	“Pre-Operational” state	[rdy]	2
	“Operational” state	[OPt]	3

9.2.16 Keypad LED operation monitor “3_41”

The status of CAN bus is displayed in the LED operation monitoring item “3_41” in the keypad.

Monitored Value	CAN bus Status
0	Normal
1	Error passive
2	Bus off

9.2.17 Keypad LED operation monitor “3_42”

The transition state of the state machine defined in the DSP-402 is displayed in the LED operation monitoring item “3_42” in the keypad.

Monitored Value	Status of the DSP-402 state machine	Inverter state
0	Invalid	y33=0
1	Not ready to switch on	Refer to Table 9.2-18.
2	Switch on disabled	
3	Ready to switch on	
4	Switched on	
5	Operation enabled	
6	Quick stop active	
7	Fault reaction active	
8	Fault	

9.2.18 Keypad LED maintenance information “5_45”

The sending error counter during communication is displayed in the LED maintenance Information item “5_45” in the keypad.

9.2.19 Keypad LED maintenance information “5_46”

The receiving error counter during communication is displayed in the LED maintenance Information item “5_46” in the keypad.

9.3 FRENIC Loader Overview

FRENIC Loader is a software tool that supports the operation of the inverter via an RS-485 communication.

This software allows you to edit, set, and manage the inverter function codes, monitor running data, and remotely operate the operation and stop, as well as monitor the running status and alarm history.



With special order-made inverters, FRENIC Loader may not be able to display some function codes normally.



For details, refer to the FRENIC Loader Instruction Manual.

9.3.1 Modes

Item	Modes	Remarks
Name	Inverter support loader (FRENIC Loader)	
Supported inverter	FRENIC-MEGA/Multi/Eco/Mini/Ace/GX1/HF	(Note 1)
Number of connected inverters	USB connection: 1 RS-485 connection: Up to 31	
Recommended cable	Cable (10BASE-T or more) compliant with EIA568 RJ-45 connector	For the RS-485 interface
Operating environment	CPU	Intel Pentium III 600 MHz or later (Note 2)
	OS	Microsoft Windows XP (32 bit) Microsoft Vista (32 bit) Microsoft 7 (32 bit, 64 bit) (Note 3)
	Memory	RAM area with 512 MB or more 1GB or more is recommended.
	Hard disk	40 MB or more of empty area
	COM port	RS-232C (conversion to RS-485 communication is required to connect inverters) or USB
	Monitor	800 x 600 or higher XGA (1024×768) 32 bit Color or more monitor is recommended.
Transmission requirements	COM port	COM1 to COM255 PC COM ports assigned to Loader
	Transmission speed	USB connection: Between loader and keypad = fixed at 12 Mbps Between keypad and inverter = fixed at 19200 (bps) RS-485 connection: 38400, 19200, 9600, 4800, 2400 (bps) 19200 bps or more is recommended (Note 4)
	Character length	8 bit Prefixed
	Stop bit length	1 bit Prefixed
	Parity	Even Prefixed
	No. of retries	None or 1 to 10 No. of retry times before detecting communication error
	Timeout setting	100 ms, 300 ms, 500 ms, 1.0 s to 1.5 s to 1.9 s, 2.0 to 9.0 s, 10.0 to 60.0 s Set longer than the "Response interval time y09"

Note 1: The loader model is unavailable which does not support the protocol for loader commands (SX protocol).

Note 2: Use a PC with as high a performance as possible, since some slow PCs may not properly refresh the operation monitoring and test-running windows.

Note 3: Only Microsoft Windows XP service pack 2 (SP2) or later is supported.

Note 4: To connect to the network where there is a FRENIC-Mini inverter, choose 19200 bps or below.

9.3.2 Connection

By connecting a number of inverters to one PC, you can control one inverter at a time or a number of inverters simultaneously. You can also simultaneously monitor a number of inverters on the multi monitor.

 For information how to connect a PC to one or more inverters, refer to the RS-485 Communication User's Manual (MEH448).

9.3.3 Function overview

[1] Configuring inverter's function code

You can set, edit, and check the setting of the inverter's function code data.

List and Edit

In List and edit, you can list and edit function codes with function code No., name, set value, set range, and factory default.

You can also list function codes by any of the following groups according to your needs:

- Function code group
- Function codes that have been modified from their factory defaults
- Result of comparison with the settings of the inverter
- Result of search by function code name
- User-specified function code set

etc.

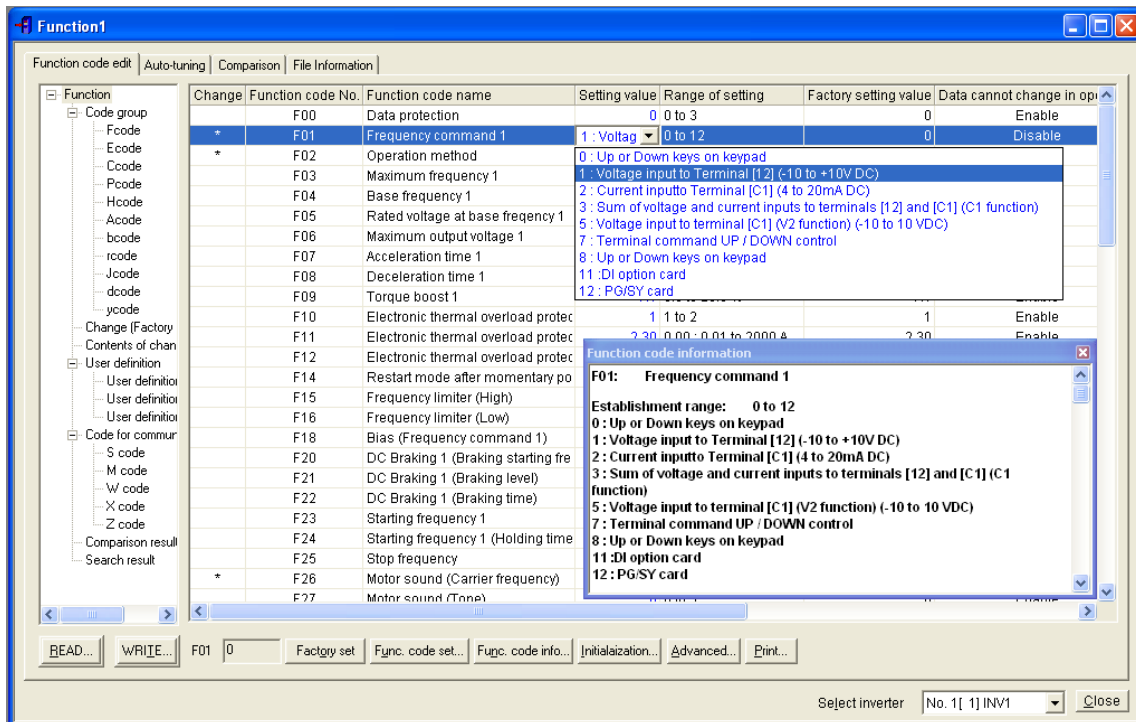

Comparison

You can compare the function code data currently being edited with that saved in a file or stored in the inverter.

To perform a comparison and review the result displayed, click the Comparison tab and then click the Compared with inverter tab or click the Compared with file tab, and specify the file name.

The result of the comparison will be displayed also in the Comparison Result column of the list.

File information

Clicking the File information tab displays the property and comments for identifying the function code editing file.

- (1) Property
Shows file name, inverter model, inverter’s capacity, date of readout, etc.
- (2) Comment
Displays the comments you have entered. You can write any comments necessary for identifying the file.

[2] Multi-monitor

This feature lists the status of all the inverters that are marked “connected” in the configuration table.

Multi-monitor

Allows you to monitor the status of more than one inverter in a list format.

The screenshot shows a window titled "Multi-monitor" with a table containing the following data:

No.	Equipment name	RS485 address	Inverter model name	Capacity	Operation status	Frequency commat	Out
1	INV1	1	G1S 3phase 200V	0.4	FWD	38.84	38.
2	INV2	2	G1S 3phase 200V	0.4	STOP	9.17	0.0
3							
4							
5							
6							
7							
8							
9							
10							
11							
12							
13							
14							
15							
16							
17							
18							
19							
20							

At the bottom of the window, there are two buttons: "Selection..." and "Close".

[3] Running status monitor

The running status monitor offers four monitor functions: I/O monitor, System monitor, Alarm monitor, and Meter display. You can choose an appropriate monitoring format according to the purpose and situation.

I/O monitor

Allows you to monitor the ON/OFF states of the digital input signals to the inverter and the transistor output signals.

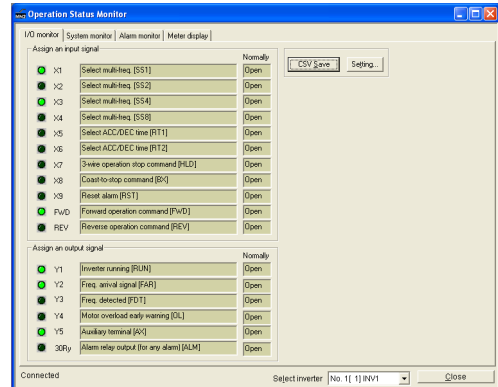

System monitor

The inverter's system information (version, type, maintenance information, etc.) can be confirmed.

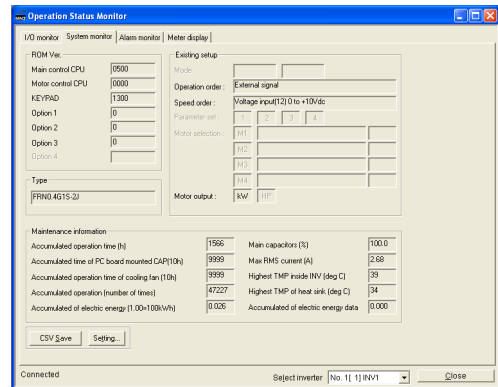

Alarm monitor

The alarm monitor shows the alarm status of the selected inverter. In this window you can check the details of the alarm currently active and related information.

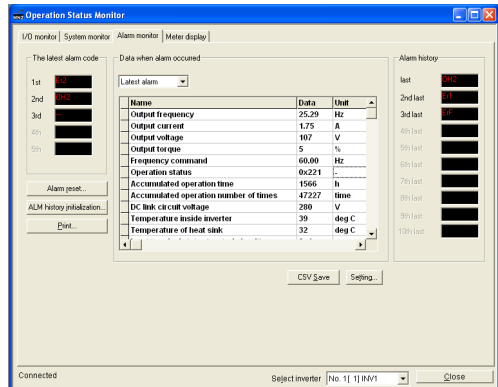

Meter display

Displays analog readouts of the selected inverter (such as output frequency) on analog meters. The example on the right displays the reference frequency and the output frequency.

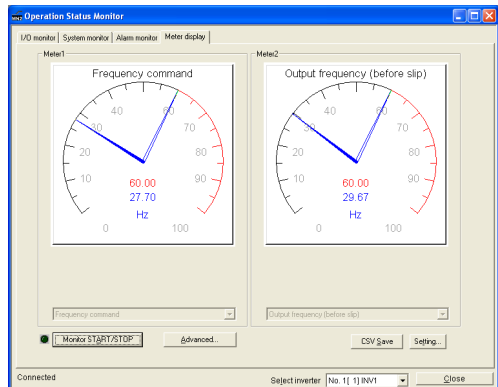

[4] Test-running

The Test-running feature allows you to test-run the motor in the forward or reverse direction while monitoring the running status of the selected inverter.

Operation status
Shows FWD, REV, STOP and alarm codes.

Select monitor item
Select what is to be displayed (e.g., output frequency or current) here using the pull-down menu.

Frequency command (updated)
Transmits the frequency entered to the inverter

I/O terminal status
Shows the status of the programmable digital I/O terminals of the inverter.

Operation buttons*

Select monitor item
Select the operation status information to be monitored in real-time.

Update with latest inverter information (updated)
Click the Refresh button to refresh the contents of this window to show the latest inverter status.

Switch the frequency and running commands (updated)
Select the frequency and run command sources and click Apply.

*: The table below lists the details of the operation buttons.

Button	Functionality
STOP	Stop the motor.
FWD	The motor runs in the normal rotation. (depressed state indicates running state.)
REV	The motor runs in the reverse rotation. (depressed state indicates running state.)
RESET	Reset all alarm information saved in the selected inverter.

[5] Real-time trace

When continuously observing the running state of inverters while the sampling time is fixed at 200 ms, up to 4 analog channels and up to 8 digital channels are available (up to 8 channels in total).

(Maximum waveform amount: 15360 sample/channel)

Type of trace

- Cursor
- Adjustment of graph positions

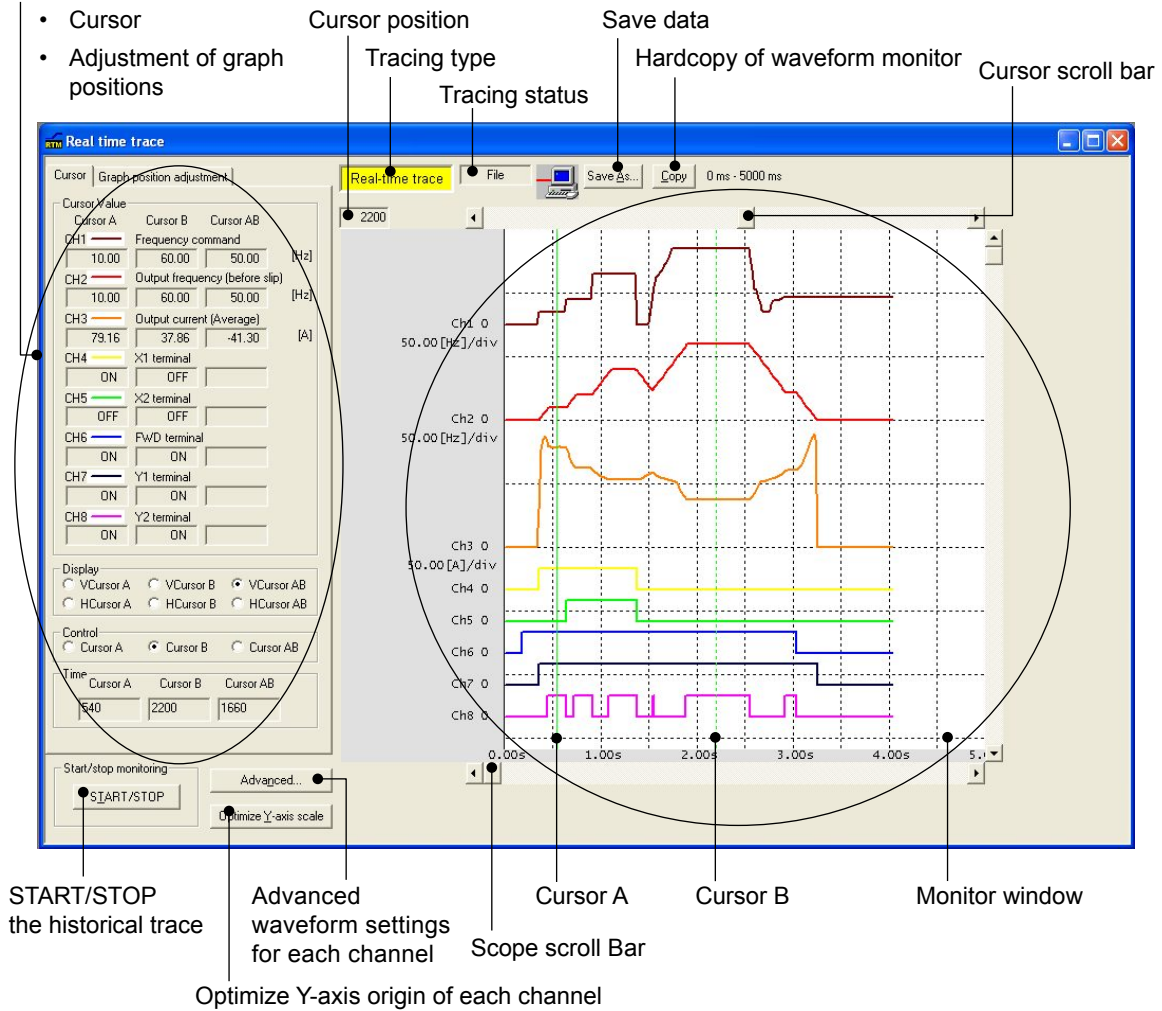

- The station No can not be changed while tracing waveforms real time.
- The detailed waveform can not be changed while tracing waveforms real time.
- Change the real time trace window to change the size of monitor window.
- The scrolling and cursor moving are unavailable in the waveform monitoring window while tracing waveforms real time.

[6] Historical trace

The sampling time can be selected between 1 ms to 200 ms. When observing the running state of inverters in much finer continuous waveforms than real-time trace, up to 4 analog channels and up to 8 digital channels are available (up to 8 channels in total).

- Amount of saved data: 2 kbyte

(Waveform capturing capability: Max. 500 sample/channel)

Type of trace

- Cursor
- Adjustment of graph positions

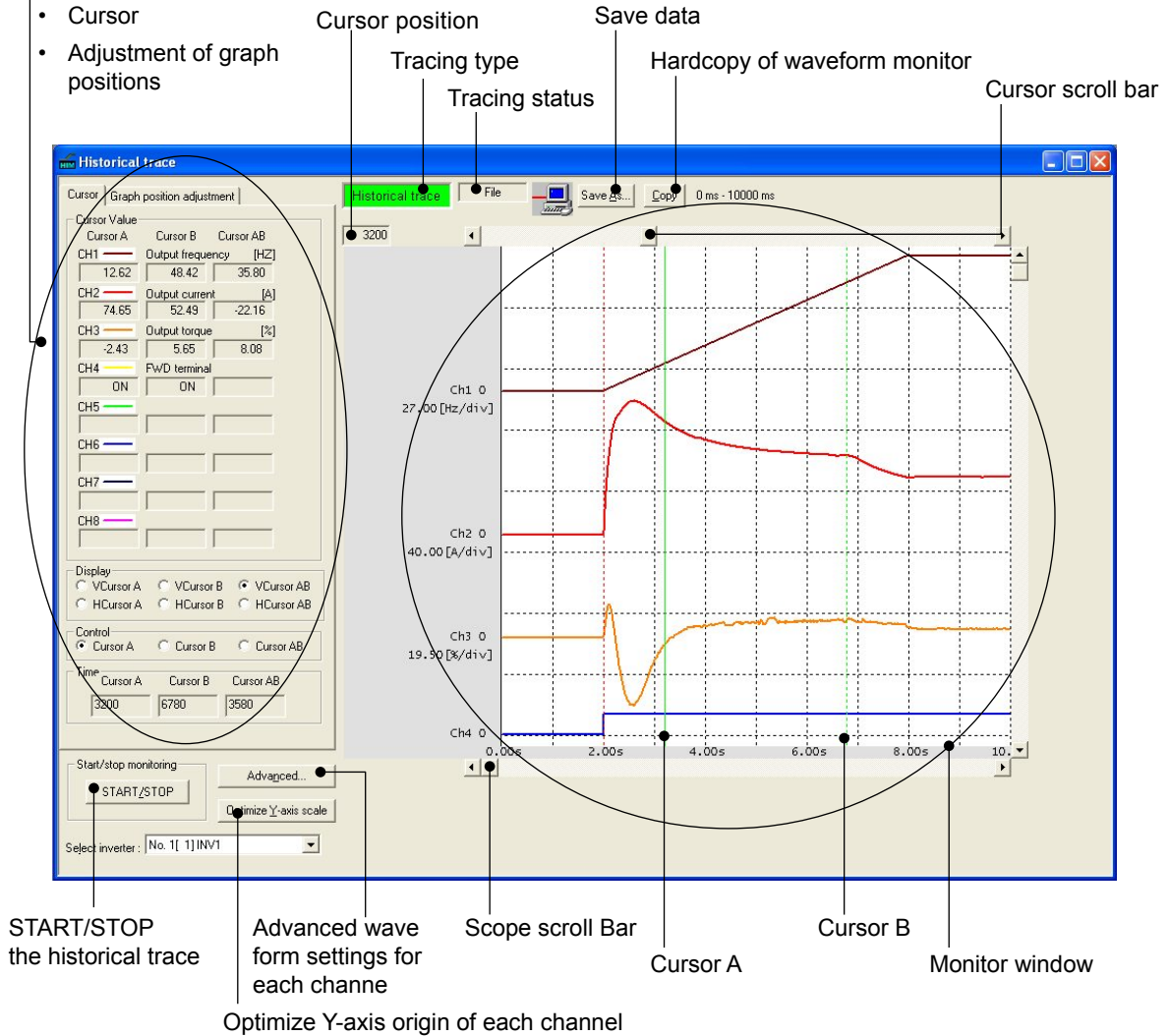

- The station No can not be changed while tracing waveforms historically.
- The detailed waveform can not be changed while tracing waveforms historically.
- Change the historical trace window to change the size of monitor window.

Chapter 10

SELECTING OPTIMAL MOTOR AND INVERTER CAPACITIES

This chapter provides information about the inverter output torque characteristics, selection procedure, and equations for calculating the capacities, in order to be able to select optimal motor and inverter models. It also helps to select the braking resistors, inverter mode (ND, HD, HND, or HHD), and motor drive control.

Contents

10.1	Motor Output Torque Characteristics	10-1
10.2	Selection Procedure	10-3
10.3	Equations for Selections	10-6
10.3.1	Load torque during constant speed running	10-6
[1]	General equation	10-6
[2]	Obtaining the required force F	10-6
10.3.2	Acceleration and deceleration time calculation	10-8
[1]	Calculation of moment of inertia	10-8
[2]	Calculation of the acceleration time	10-10
[3]	Calculation of the deceleration time	10-11
[4]	Calculating non-linear acceleration/deceleration time	10-11
[5]	Calculating non-linear deceleration time	10-12
10.3.3	Heat energy calculation of braking resistor	10-13
[1]	Calculation of regenerative energy	10-13
10.3.4	Calculating the RMS rating of the motor	10-14
10.4	Selecting an Inverter Drive Mode (ND/HD/HND/HHD)	10-15
10.4.1	Precaution in making the selection	10-15
10.4.2	Guideline for selecting inverter drive mode and capacity	10-16

When selecting a general-purpose inverter, first select a motor and then inverter as follows:

- (1) Key point for selecting a motor: Determine what kind of load machine is to be used, calculate its moment of inertia, and then select the appropriate motor capacity.
- (2) Key point for selecting an inverter: Taking into account the operation requirements (e.g., acceleration time, deceleration time, and frequency in operation) of the load machine to be driven by the motor selected in (1) above, calculate the acceleration/deceleration/braking torque.

This section describes the selection procedure for (1) and (2) above. First, it explains the output torque characteristics obtained by using the motor driven by the inverter (FRENIC-Ace).

10.1 Motor Output Torque Characteristics

Figure 10.1-1 and Figure 10.1-2 graph the output torque characteristics of motors versus the output frequency for 50 Hz and 60 Hz base frequencies. The horizontal and vertical axes show the output frequency and output torque (%), respectively. Curves (a) through (f) depend on the running conditions.

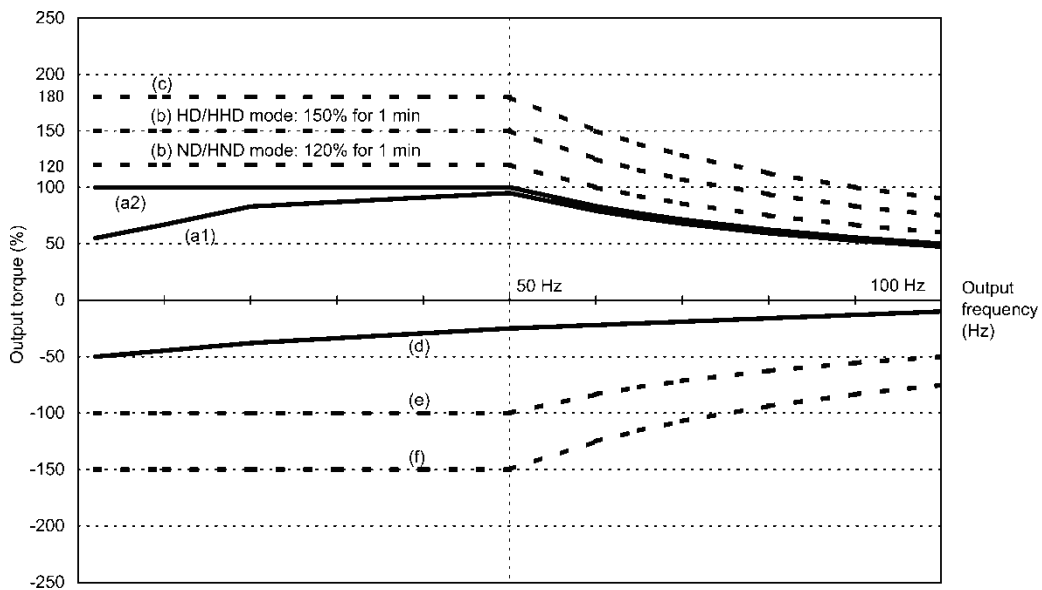

Figure 10.1-1 Output Torque Characteristics (Base frequency: 50 Hz)

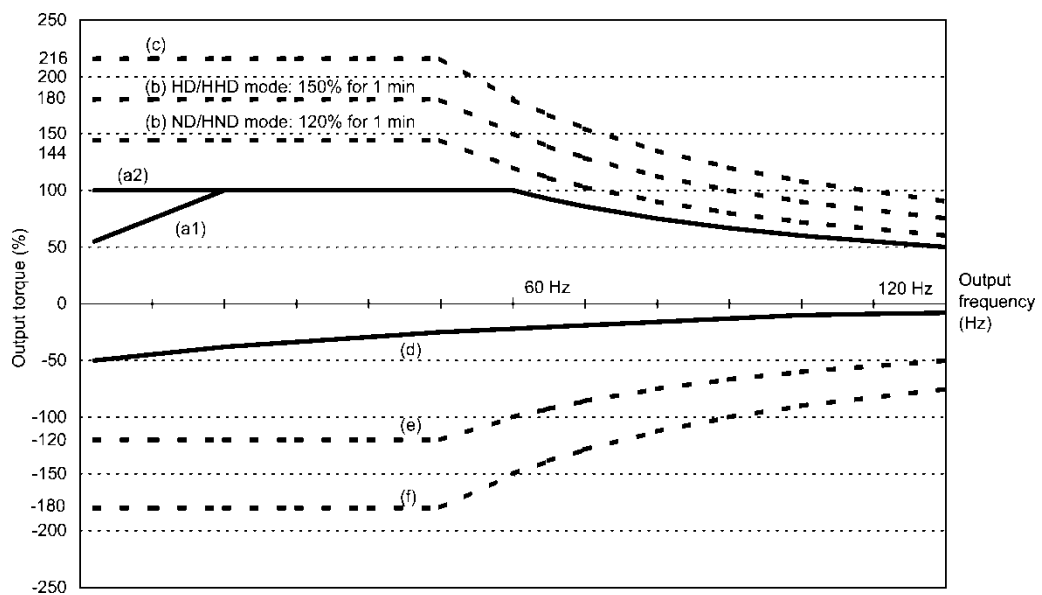

Figure 10.1-2 Output Torque Characteristics (Base frequency: 60 Hz)

(1) Continuous allowable driving torque

① Standard motor (Curve (a1) in Figure 10.1-1 and Figure 10.1-2)

Curve (a1) shows the torque characteristic that can be obtained in the range of the inverter continuous rated current, where the standard motor's cooling characteristic is taken into consideration. When the motor runs at the base frequency of 60 Hz, 100 % output torque can be obtained; at 50 Hz, the output torque is somewhat lower than that in commercial power, and it further lowers at lower frequencies. The reduction of the output torque at 50 Hz is due to increased loss by inverter driving, and that at lower frequencies is mainly due to heat generation caused by the decreased ventilation performance of the motor cooling fan.

② Motor exclusively designed for vector control (Curve (a2) in Figure 10.1-1 and Figure 10.1-2)

Curve (a2) shows the torque characteristic that can be obtained in the range of the inverter continuous rated current, where the motor exclusively designed for vector control is connected. In the motor exclusively designed for vector control, the attached forced-cooling fan reduces heat generation from the motor, so that the torque does not drop in the low-speed range, compared to the standard motor.

(2) Maximum driving torque in a short time (Curves (b) and (c) in Figure 10.1-1 and Figure 10.1-2)

Curve (b) shows the torque characteristic that can be obtained in the range of the inverter overload capability in a short time (ND/HND mode: 120% for 1 minute, HD mode: 150% for 1 minute, HHD mode: 150% for 1 minute and 200% for 0.5 seconds) when torque-vector control is enabled. At that time, the motor cooling characteristics have little effect on the output torque.

Curve (c) shows an example of the torque characteristic when one class higher capacity inverter is used to increase the short-time maximum torque. In this case, the short-time torque is 20 to 30% greater than that when the standard capacity inverter is used.

(3) Starting torque (around the output frequency 0 Hz in Figure 10.1-1 and Figure 10.1-2)

The maximum torque in a short time applies to the starting torque as it is.

(4) Braking torque (Curves (d), (e), and (f) in Figure 10.1-1 and Figure 10.1-2)

In braking the motor, kinetic energy is converted to electrical energy and regenerated to the DC link bus capacitor (reservoir capacitor) of the inverter. Discharging this electrical energy to the braking resistor produces a large braking torque as shown in curve (e). If no braking resistor is provided, however, only the motor and inverter losses consume the regenerated braking energy so that the torque becomes smaller as shown in curve (d).

When an optional braking resistor is used, the braking torque is allowable only for a short time. Its time ratings are mainly determined by the braking resistor ratings. This manual and associated catalogs list the allowable values (kW) obtained from the average discharging loss and allowable values (kW) obtained from the discharging capability that can be discharged at one time.

Note that the torque % value varies according to the inverter capacity.

Selecting an optimal brake unit enables a braking torque value to be selected comparatively freely in the range below the short-time maximum torque in the driving mode, as shown in curve (f).

 For braking-related values when the inverter and braking resistor are normally combined, refer to Chapter 11 "11.8 Braking Resistors (DBRs) and Braking Units."

10.2 Selection Procedure

Figure 10.2-1 shows the general selection procedure for optimal inverters. Items numbered (1) through (5) are described on the following pages.

You may easily select inverter capacity if there are no restrictions on acceleration and deceleration times. If “there are any restrictions on acceleration or deceleration time” or “acceleration and deceleration are frequent,” then the selection procedure is more complex.

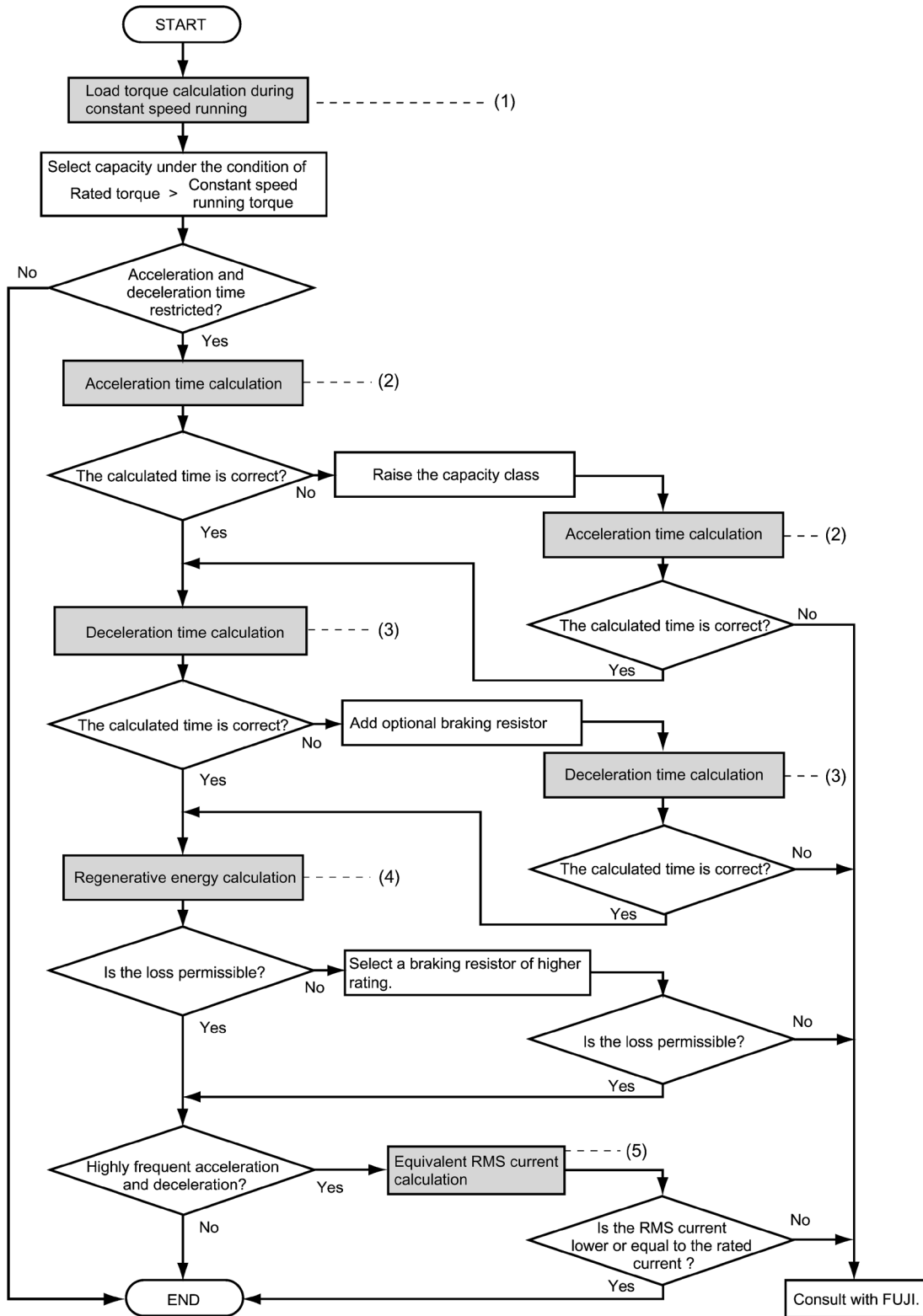

Figure 10.2-1 Selection Procedure

(1) Calculating the load torque during constant speed running

(For detailed calculation, refer to Section 10.3.1 .)

It is essential to calculate the load torque during constant speed running for all loads.

First calculate the load torque of the motor during constant speed running and then select a tentative capacity so that the continuous rated torque of the motor during constant speed running becomes higher than the load torque. To perform capacity selection efficiently, it is necessary to match the rated speeds (base speeds) of the motor and load. To do this, select an appropriate reduction-gear (mechanical transmission) ratio and the number of motor poles.

If the acceleration or deceleration time is not restricted, the tentative capacity can apply as a defined capacity.

(2) Calculating the acceleration time (For detailed calculation, refer to Section 10.3.2 [2] .)

When there are some specified requirements for the acceleration time, calculate it according to the following procedure:

1) Calculate the **moment of inertia** for the load and motor

Calculate the moment of inertia for the load, referring to “10.3.2 Acceleration and deceleration time calculation.”

For the moment of inertia for motors, refer to the related motor catalogs.

2) Calculate the minimum acceleration torque (See Figure 10.2-2)

The acceleration torque is the difference between the motor short-time output torque (base frequency: 60 Hz) explained in “10.1 (2) Maximum driving torque in a short time” and the load torque (τ_L / η_G) during constant speed running calculated in the above (1) . Calculate the minimum acceleration torque for the whole range of speed.

3) Calculate the acceleration time

Assign the value calculated above to the equation (Equation 10.3-15) in “10.3.2 Acceleration and deceleration time calculation” to calculate the acceleration time. If the calculated acceleration time is longer than the expected time, select the inverter and motor having one class larger capacity and calculate it again.

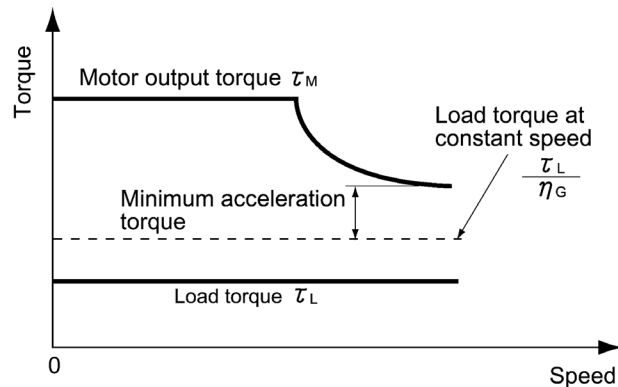

Figure 10.2-2 Example Study of Minimum Acceleration Torque

(3) Deceleration time (For detailed calculation, refer to Section 10.3.2 [4] .)

To calculate the deceleration time, check the motor deceleration torque characteristics for the whole range of speed in the same way as for the acceleration time.

- 1) Calculate the moment of inertia for the load and motor
Same as for the acceleration time.
- 2) Calculate the minimum deceleration torque (See Figure 10.2-3 and Figure 10.2-4)
Same as for the deceleration time.
- 3) Calculate the deceleration time

Assign the value calculated above to the equation (Equation 10.3-16) to calculate the deceleration time in the same way as for the acceleration time. If the calculated deceleration time is longer than the requested time, select the inverter and motor having one class larger capacity and calculate it again.

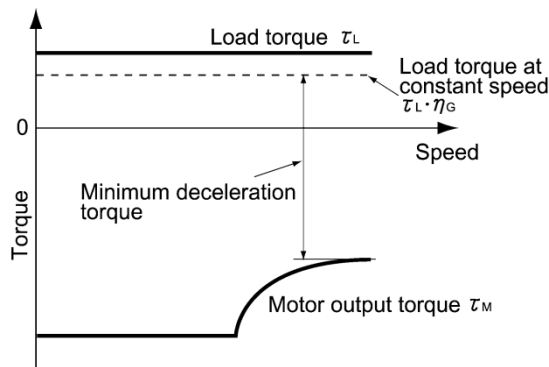

Figure 10.2-3 Example Study of Minimum Deceleration Torque (1)

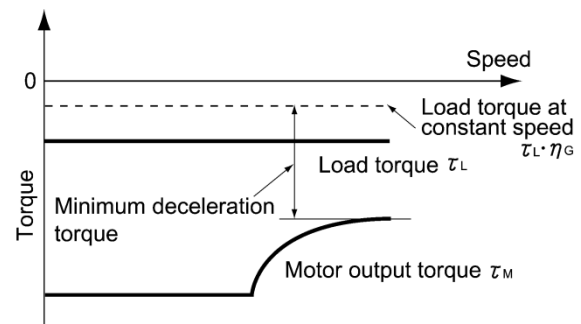

Figure 10.2-4 Example Study of Minimum Deceleration Torque (2)

(4) Braking resistor rating (For detailed calculation, refer to Section 10.3.3 .)

Braking resistor rating is classified into two types according to the braking periodic duty cycle.

- 1) When the periodic duty cycle is 100 seconds or less:
Calculate the average loss to determine rated values.
- 2) When the periodic duty cycle exceeds 100 seconds:
The allowable braking energy depends on the maximum regenerative braking capacity. The allowable values are listed in Chapter 11 "11.8 Braking Resistors (DBRs) and Braking Units."

(5) Motor RMS current (For detailed calculation, refer to Section 10.3.4 .)

In metal processing machines and materials handling machines requiring positioning control, highly frequent running for a short time is repeated. In this case, calculate the maximum equivalent RMS current value (effective value of current) not to exceed the allowable value (rated current) for the motor.

10.3 Equations for Selections

10.3.1 Load torque during constant speed running

[1] General equation

The frictional force acting on a horizontally moved load must be calculated. Calculation for driving a load along a straight line with the motor is shown below.

Where the force to move a load linearly at constant speed v (m/s) is F (N) and the motor speed for driving this is N_M (r/min), the required motor output torque τ_M (N·m) is as follows:

$$\tau_M = \frac{60 \cdot v}{2 \pi \cdot N_M} \cdot \frac{F}{\eta_G} \quad (\text{N} \cdot \text{m}) \quad (\text{Equation 10.3-1})$$

where, η_G is Reduction-gear efficiency.

When the inverter brakes the motor, efficiency works inversely, so the required motor torque should be calculated as follows:

$$\tau_M = \frac{60 \cdot v}{2 \pi \cdot N_M} \cdot F \cdot \eta_G \quad (\text{N} \cdot \text{m}) \quad (\text{Equation 10.3-2})$$

$(60 \cdot v) / (2\pi \cdot N_M)$ in the above equation is an equivalent turning radius corresponding to speed v (m/s) around the motor shaft.

The value F (N) in the above equations depends on the load type.

[2] Obtaining the required force F

■ Moving a load horizontally

A simplified mechanical configuration is assumed as shown in Figure 10.3-1. If the mass of the carrier table is W_0 (kg), the load is W (kg), and the friction coefficient of the ball screw is μ , then the friction force F (N) is expressed as follows, which is equal to a required force for driving the load:

$$F = (W_0 + W) \cdot g \cdot \mu \quad (\text{N}) \quad (\text{Equation 10.3-3})$$

where, g is the gravity acceleration (≈ 9.8 (m/s²)).

Then, the driving torque around the motor shaft is expressed as follows:

$$\tau_M = \frac{60 \cdot v}{2 \pi \cdot N_M} \cdot \frac{(W_0 + W) \cdot g \cdot \mu}{\eta_G} \quad (\text{N} \cdot \text{m}) \quad (\text{Equation 10.3-4})$$

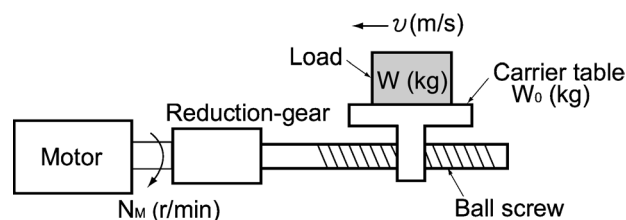

Figure 10.3-1 Moving a Load Horizontally

■ Vertical lift load

A simplified mechanical configuration is assumed as shown in Figure 10.3-2. If the mass of the cage is W_0 (kg), the load is W (kg), and the balance weight is W_B (kg), then the forces F (N) required for lifting the load up and down are expressed as follows:

For lifting up

$$F = (W_0 + W - W_B) \cdot g \text{ (N)} \tag{Equation 10.3-5}$$

For lifting down

$$F = (W_0 - W - W_B) \cdot g \text{ (N)} \tag{Equation 10.3-6}$$

Assuming the maximum load is W_{max} , the mass of the balance weight W_B (kg) is generally obtained with the expression $W_B = W_0 + W_{max} / 2$. Depending on the mass of load W (kg), the values of F (N) may be negative in both cases of lifting up and down, which means the lift is in braking mode. So, be careful in motor and inverter selection. For calculation of the required output torque τ around the motor shaft, apply the expression (Equation 10.3-1) or (Equation 10.3-2) depending on the driving or braking mode of the lift, that is, apply the expression (Equation 10.3-1) if the value of F (N) is positive, and the (Equation 10.3-2) if negative.

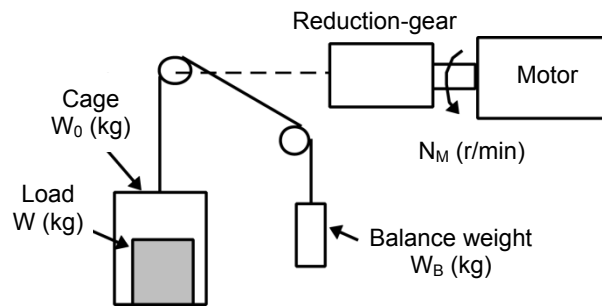

Figure 10.3-2 Vertical Lift Load

■ Inclined lift load

Although the mechanical configuration of an inclined lift load is similar to that of a vertical lift load, non negligible friction force in the inclined lift makes the difference; in an inclined lift load, there is a distinct difference between the expression to calculate the lift force F (N) for lifting up and that for lifting down.

If the incline angle is θ , and the friction coefficient is μ , as shown in Figure 10.3-3, the driving force F (N) is expressed as follows:

For lifting up

$$F = ((W_0 + W) (\sin\theta + \mu \cdot \cos\theta) - W_B) \cdot g \text{ (N)} \tag{Equation 10.3-7}$$

For lifting down

$$F = ((W_B - (W_0 + W) (\sin\theta + \mu \cdot \cos\theta)) \cdot g \text{ (N)} \tag{Equation 10.3-8}$$

The braking mode applies to both lifting up and down as in the vertical lift load. And the calculation of the required output torque τ around the motor shaft is the same as in the vertical lift load; apply the expression (Equation 10.3-1) if the value of F (N) is positive, and the (Equation 10.3-2) if negative.

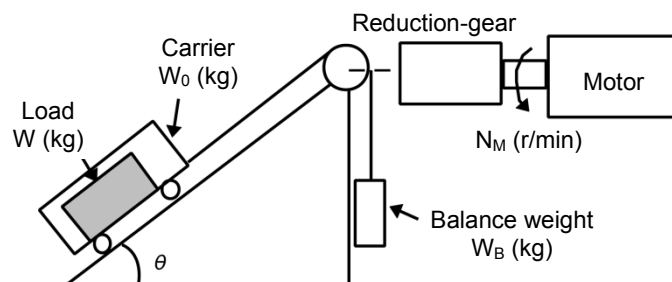

Figure 10.3-3 Inclined Lift Load

10.3.2 Acceleration and deceleration time calculation

When an object whose moment of inertia is J ($\text{kg}\cdot\text{m}^2$) rotates at the speed N (r/min), it has the following kinetic energy:

$$E = \frac{J}{2} \cdot \left(\frac{2\pi \cdot N}{60} \right)^2 \quad (\text{J}) \quad (\text{Equation 10.3-9})$$

To accelerate the above rotational object, the kinetic energy will be increased; to decelerate the object, the kinetic energy must be discharged. The torque required for acceleration and deceleration can be expressed as follows:

$$\tau = J \cdot \frac{2\pi}{60} \left(\frac{dN}{dt} \right) \quad (\text{N}\cdot\text{m}) \quad (\text{Equation 10.3-10})$$

This way, the mechanical moment of inertia is an important element in the acceleration and deceleration. First, calculation method of moment of inertia is described, after the calculation methods for the acceleration and deceleration times are explained.

[1] Calculation of moment of inertia

For an object that rotates around the shaft, virtually divide the object into small segments and square the distance from the shaft to each segment. Then, sum the squares of the distances and the masses of the segments to calculate the moment of inertia.

$$J = \sum (W_i \cdot r_i^2) \quad (\text{kg}\cdot\text{m}^2) \quad (\text{Equation 10.3-11})$$

The following describes equations to calculate moment of inertia having different shaped loads or load systems.

(1) Hollow cylinder and solid cylinder

The common shape of a rotating body is hollow cylinder. The moment of inertia J ($\text{kg}\cdot\text{m}^2$) around the hollow cylinder center axis can be calculated as follows, where the outer and inner diameters are D_1 and D_2 [m] and total mass is W [kg] in Figure 10.3-4.

$$J = \frac{W \cdot (D_1^2 + D_2^2)}{8} \quad (\text{kg}\cdot\text{m}^2) \quad (\text{Equation 10.3-12})$$

For a similar shape, a solid cylinder, calculate the moment of inertia as D_2 is 0.

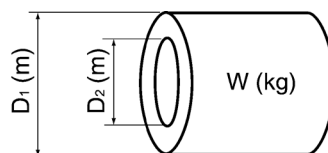
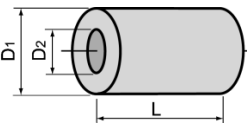
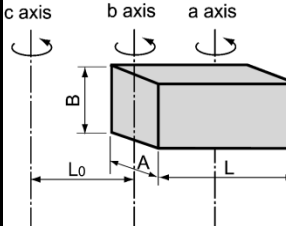
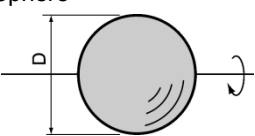
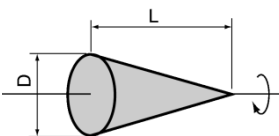
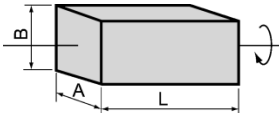
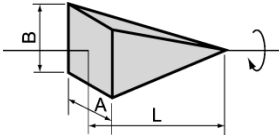
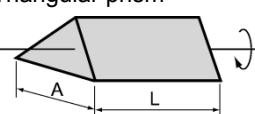
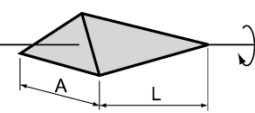

Figure 10.3-4 Hollow Cylinder

(2) For a general rotating body

Table 10.3-1 lists the calculation equations of moment of inertia of various rotating bodies including the above cylindrical rotating body.

Table 10.3-1 Moment of Inertia of Various Rotating Bodies

Shape	Mass: W (kg)	Shape	Mass: W (kg)
	Moment of inertia: J (kg·m ²)		Moment of inertia: J (kg·m ²)
 <p>Hollow cylinder</p>	$W = \frac{\pi}{4} \cdot (D_1^2 - D_2^2) \cdot L \cdot \rho$ $J = \frac{1}{8} \cdot W \cdot (D_1^2 + D_2^2)$		$W = A \cdot B \cdot L \cdot \rho$ $J_a = \frac{1}{12} \cdot W \cdot (L^2 + A^2)$ $J_b = \frac{1}{12} \cdot W \cdot (L^2 + \frac{1}{4} \cdot A^2)$ $J_c \approx W \cdot (L_0^2 + L_0 \cdot L + \frac{1}{3} \cdot L^2)$
 <p>Sphere</p>	$W = \frac{\pi}{6} \cdot D^3 \cdot \rho$ $J = \frac{1}{10} \cdot W \cdot D^2$	 <p>Cone</p>	$W = \frac{\pi}{4} \cdot D^2 \cdot L \cdot \rho$ $J_a = \frac{1}{12} \cdot W \cdot (L^2 + \frac{3}{4} \cdot D^2)$ $J_b = \frac{1}{3} \cdot W \cdot (L^2 + \frac{3}{16} \cdot D^2)$ $J_c \approx W \cdot (L_0^2 + L_0 \cdot L + \frac{1}{3} \cdot L^2)$
 <p>Rectangular prism</p>	$W = A \cdot B \cdot L \cdot \rho$ $J = \frac{1}{12} \cdot W \cdot (A^2 + B^2)$	 <p>Square cone (Pyramid, rectangular base)</p>	$W = \frac{\pi}{3} \cdot A \cdot B \cdot L \cdot \rho$ $J_b = \frac{1}{10} \cdot W \cdot (L^2 + \frac{1}{4} \cdot A^2)$ $J_c \approx W \cdot (L_0^2 + \frac{3}{2} \cdot L_0 \cdot L + \frac{3}{5} \cdot L^2)$
 <p>Triangular prism</p>	$W = \frac{\sqrt{3}}{4} \cdot A^2 \cdot L \cdot \rho$ $J = \frac{1}{3} \cdot W \cdot A^2$	 <p>Tetrahedron with an equilateral triangular base</p>	$W = \frac{\pi}{12} \cdot D^2 \cdot L \cdot \rho$ $J_b = \frac{1}{10} \cdot W \cdot (L^2 + \frac{3}{8} \cdot D^2)$ $J_c \approx W \cdot (L_0^2 + \frac{3}{2} \cdot L_0 \cdot L + \frac{3}{5} \cdot L^2)$
<p>Main metal density (at 20°C) ρ(kg/m³) Iron: 7860, Copper: 8940, Aluminum: 2700</p>			

(3) For a load running horizontally

Assume a carrier table driven by a motor as shown in Figure 10.3-1. If the table speed is v (m/s) when the motor speed is N_M (r/min), then an equivalent distance from the shaft is equal to $60 \cdot v / (2\pi \cdot N_M)$ (m). The moment of inertia of the table and load to the shaft is calculated as follows:

$$J = \left(\frac{60 \cdot v}{2 \pi \cdot N_M} \right)^2 \cdot (W_0 + W) \quad (\text{kg} \cdot \text{m}^2) \quad \text{(Equation 10.3-13)}$$

(4) For a vertical or inclined lift load

The moment of inertia J ($\text{kg} \cdot \text{m}^2$) of the loads connected with a rope as shown in Figure 10.3-2 and Figure 10.3-3 is calculated with the following equation using the mass of all moving objects, although the motion directions of those loads are different.

$$J = \left(\frac{60 \cdot v}{2 \pi \cdot N_M} \right)^2 \cdot (W_0 + W + W_g) \quad (\text{kg} \cdot \text{m}^2) \quad \text{(Equation 10.3-14)}$$

[2] Calculation of the acceleration time

Figure 10.3-5 shows a general load model. Assume that a motor drives a load via a reduction-gear with efficiency η_G . The time required to accelerate this load in stop state to a speed of N_M (r/min) is calculated with the following equation:

$$t_{\text{ACC}} = \frac{J_1 + J_2/\eta_G}{\tau_M - \tau_L/\eta_G} \cdot \frac{2\pi \cdot (N_M - 0)}{60} \quad (\text{s}) \quad \text{(Equation 10.3-15)}$$

where,

- J_1 : Motor shaft moment of inertia ($\text{kg} \cdot \text{m}^2$)
- J_2 : Load shaft moment of inertia converted to motor shaft ($\text{kg} \cdot \text{m}^2$)
- τ_M : Minimum motor output torque in driving motor ($\text{N} \cdot \text{m}$)
- τ_L : Maximum load torque converted to motor shaft ($\text{N} \cdot \text{m}$)
- η_G : Reduction-gear efficiency.

As clarified in the above equation, the equivalent moment of inertia becomes $(J_1 + J_2/\eta_G)$ by considering the reduction-gear efficiency.

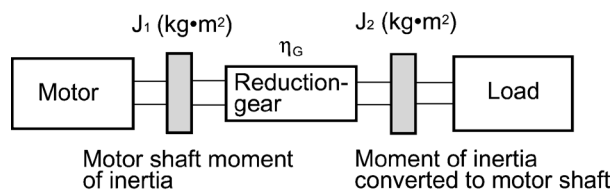

Figure 10.3-5 Load Model Including Reduction-gear

[3] Calculation of the deceleration time

In a load system shown in Figure 10.3-5, the time needed to stop the motor rotating at a speed of N_M (r/min) is calculated with the following equation:

$$t_{DEC} = \frac{J_1 + J_2 \cdot \eta_G}{\tau_M - \tau_L \cdot \eta_G} \cdot \frac{2\pi \cdot (0 - N_M)}{60} \quad (\text{s}) \quad (\text{Equation 10.3-16})$$

where,

- J_1 : Motor shaft moment of inertia ($\text{kg} \cdot \text{m}^2$)
- J_2 : Load shaft moment of inertia converted to motor shaft ($\text{kg} \cdot \text{m}^2$)
- τ_M : Minimum motor output torque in braking (or decelerating) motor ($\text{N} \cdot \text{m}$)
- τ_L : Maximum load torque converted to motor shaft ($\text{N} \cdot \text{m}$)
- η_G : Reduction-gear efficiency

In the above equation, generally output torque τ_M is negative and load torque τ_L is positive. So, deceleration time becomes shorter.



For lift applications, calculate the deceleration time using the negative value of τ_L (maximum load torque converted to motor shaft).

[4] Calculating non-linear acceleration/deceleration time

In applications requiring frequent acceleration/deceleration, the inverter can accelerate/decelerate the motor in the shortest time utilizing the maximum torque capability. The inverter in vector control mode can easily perform this type of operation.

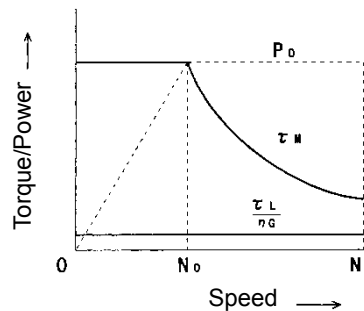

Figure 10.3-6 An Example of Driving Characteristics with a Constant Output Range

In this case, the acceleration/deceleration vs. speed curve will form a non-linear figure, and the acceleration / deceleration time cannot be calculated by a single expression.

Generally, the acceleration/deceleration time is obtained by calculating the acceleration/deceleration time of ΔN that is a difference of speed N broken into small parts, and then integrating it to obtain the total acceleration/deceleration time from start to end. Because the smaller ΔN provides higher accuracy, this numerical calculation needs an aid of a computer program.

The following is a guide for the numerical calculation method using a computer program.

Figure 10.3-6 illustrates an example of driving characteristics with a constant output range. In the figure, the range under N_0 is of constant torque characteristics, and the range between N_0 and N_1 is of a constant output with the non-linear acceleration/deceleration characteristics.

The expression (Equation 10.3-17) gives an acceleration time Δt_{ACC} within a ΔN speed increment.

$$\Delta t_{DEC} = \frac{J_1 + J_2 / \eta_G}{\tau_M - \tau_L / \eta_G} \cdot \frac{2\pi \cdot \Delta N}{60} \quad (\text{s}) \quad (\text{Equation 10.3-17})$$

Before proceeding this calculation, obtain the motor shaft moment of inertia J_1 , the load shaft moment of inertia converted to motor shaft J_2 , maximum load torque converted to motor shaft τ_L , and the reduction-gear efficiency η_G . Apply the maximum motor output torque τ_M according to an actual speed thread ΔN as follows.

$[\tau_M \text{ in } N \leq N_0]$ Constant output torque range

$$\tau_M = \frac{60 \cdot P_0}{2\pi \cdot N_0} \quad (\text{N}\cdot\text{m}) \quad (\text{Equation 10.3-18})$$

$[\tau_M \text{ in } N_0 \leq N \leq N_1]$ Constant output power range
(The motor output torque is inversely proportional to the motor speed)

$$\tau_M = \frac{60 \cdot P_0}{2\pi \cdot N} \quad (\text{N}\cdot\text{m}) \quad (\text{Equation 10.3-19})$$

If the result obtained by the above calculation does not satisfy the target value, select an inverter with one rank higher capacity.

[5] Calculating non-linear deceleration time

Use the following expression to obtain the non-linear deceleration time as well as for the acceleration time.

$$\Delta t_{\text{DEC}} = \frac{J_1 + J_2 \cdot \eta_G}{\tau_M - \tau_L \cdot \eta_G} \cdot \frac{2\pi \cdot \Delta N}{60} \quad (\text{s}) \quad (\text{Equation 10.3-20})$$

In this expression, both τ_M , and ΔN are generally negative values so that the load torque τ_L serves to assist the deceleration operation. For a lift load, however, the load torque τ_L is a negative value in some modes. In this case, the τ_M , and τ_L will take polarity opposite to each other and the τ_L will actuate to prevent the deceleration operation of the lift.

10.3.3 Heat energy calculation of braking resistor

If the inverter brakes the motor, the kinetic energy of mechanical load is converted to electric energy to be regenerated into the inverter circuit. This regenerative energy is often consumed in so-called braking resistors as heat. The following explains the braking resistor rating.

[1] Calculation of regenerative energy

In the inverter operation, one of the regenerative energy sources is the kinetic energy that is generated when an object with moment of inertia J is rotating.

(1) Kinetic energy of a moving object

When an object with moment of inertia J ($\text{kg}\cdot\text{m}^2$) rotates at a speed N_2 (r/min), its kinetic energy is as follows:

$$E = \frac{J}{2} \cdot \left(\frac{2\pi \cdot N_2}{60} \right)^2 \quad (\text{J=Ws}) \quad (\text{Equation 10.3-21})$$

$$\approx \frac{1}{182.4} \cdot J \cdot N_2^2 \quad (\text{J}) \quad (\text{Equation 10.3-21'})$$

When this object is decelerated to a speed N_1 (r/min), the output energy is as follows:

$$E = \frac{J}{2} \cdot \left[\left(\frac{2\pi \cdot N_2}{60} \right)^2 - \left(\frac{2\pi \cdot N_1}{60} \right)^2 \right] \quad (\text{J}) \quad (\text{Equation 10.3-22})$$

$$\approx \frac{1}{182.4} \cdot J \cdot (N_2^2 - N_1^2) \quad (\text{J}) \quad (\text{Equation 10.3-22'})$$

The energy regenerated to the inverter as shown in Figure 10.3-5 is calculated from the reduction-gear efficiency η_G and motor efficiency η_M as follows:

$$E \approx \frac{1}{182.4} \cdot (J_1 + J_2 \cdot \eta_G) \cdot \eta_M \cdot (N_2^2 - N_1^2) \quad (\text{J}) \quad (\text{Equation 10.3-23})$$

(2) Potential energy of a lift

When an object whose mass is W (kg) falls from the height h_2 (m) to the height h_1 (m), the output energy is as follows:

$$F = W \cdot g \cdot (h_2 - h_1) \quad (\text{J=Ws}) \quad (\text{Equation 10.3-24})$$

$$g \approx 9.8065 \quad (\text{m/s}^2)$$

The energy regenerated to the inverter is calculated from the reduction-gear efficiency η_G and motor efficiency η_M as follows:

$$F = W \cdot g \cdot (h_2 - h_1) \cdot \eta_G \cdot \eta_M \quad (\text{J}) \quad (\text{Equation 10.3-25})$$

10.3.4 Calculating the RMS rating of the motor

In case of the load which is repeatedly and very frequently driven by a motor, the motor current fluctuates largely and enters the short-time rating range of the motor repeatedly. Therefore, you have to review the allowable thermal rating of the motor. The heat value is assumed to be approximately proportional to the square of the motor current.

If an inverter drives a motor in duty cycles that are much shorter than the thermal time constant of the motor, calculate the “equivalent RMS current” as mentioned below, and select the motor so that this RMS current will not exceed the rated current of the motor.

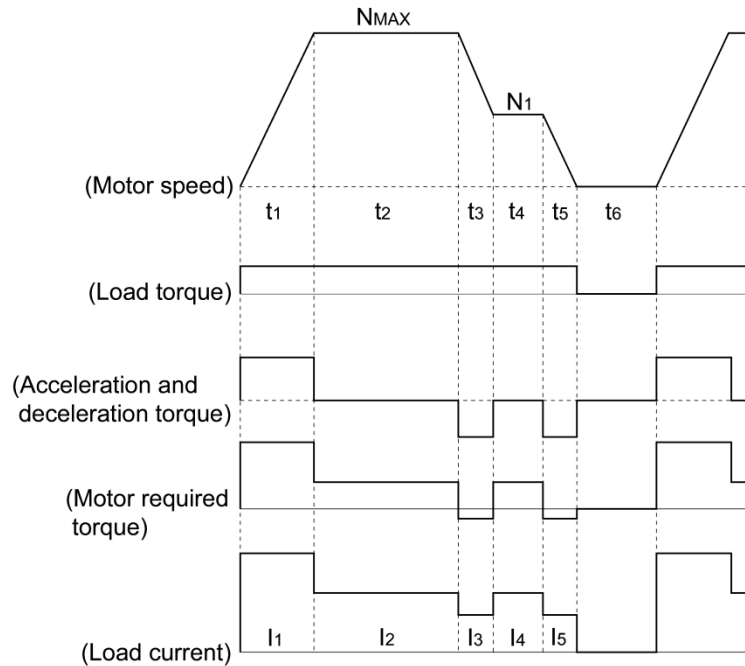

Figure 10.3-7 Sample of the Repetitive Operation

First, calculate the required torque of each part based on the speed pattern. Then using the torque-current curve of the motor, convert the torque to the motor current. The “equivalent RMS current, I_{eq} ” can be finally calculated by the following equation:

$$I_{eq} = \sqrt{\frac{I_1^2 \cdot t_1 + I_2^2 \cdot t_2 + I_3^2 \cdot t_3 + I_4^2 \cdot t_4 + I_5^2 \cdot t_5}{t_1 + t_2 + t_3 + t_4 + t_5 + t_6}} \quad (\text{A}) \quad (\text{Equation 10.3-26})$$

The torque-current curve for the dedicated motor is not available for actual calculation. Therefore, calculate the motor current I from the load torque τ_1 using the following equation (Equation 10.3-27). Then, calculate the equivalent current I_{eq} :

$$I = \sqrt{\left(\frac{\tau_1}{100} \times I_{t100}\right)^2 + I_{m100}^2} \quad (\text{A}) \quad (\text{Equation 10.3-27})$$

Where, τ_1 is the load torque (%), I_{t100} is the torque current, and I_{m100} is exciting current.

10.4 Selecting an Inverter Drive Mode (ND/HD/HND/HHD)

10.4.1 Precaution in making the selection

The FRENIC-Ace is available in four different drive modes--ND and HD modes for general load and HND and HHD modes for heavy duty load, which allows users to switch the drive modes on site.

Select the inverter capacity appropriate to the user application, considering the motor capacity, overload characteristics, and ND/HD/HND/HHD mode, referring to "10.4.2 Guideline for selecting inverter drive mode and capacity."

ND mode for general load

Apply to equipment where the inverter's load current in normal operations is less than the inverter rated current and the load current in overcurrent operation is less than 120% of the rated current for 1 minute. (fan, pump, etc.)

HD mode for heavy duty load

Apply to equipment where the inverter's load current in normal operations is less than the inverter rated current and the load current in overcurrent operation is less than 150% of the rated current for 1 minute. (wire drawing machine, etc.)

HND mode general load

Apply to equipment where the inverter's load current in normal operations is less than the inverter rated current and the load current in overcurrent operation is less than 120% of the rated current for 1 minute. This mode is for applications which require running the motor under low noise conditions or running the inverter with high responsibility. (fan, pump, centrifugal machine, etc.)

HHD mode for heavy duty load

Apply to equipment where the inverter's load current in normal operations is less than the inverter rated current and the load current in overcurrent operation is less than 150% of the rated current for 1 minute and 200% for 0.5 second. This mode is for applications which require running the motor under low noise conditions or running the inverter with high responsibility. (compact hoist, winding machine, etc.)

10.4.2 Guideline for selecting inverter drive mode and capacity

Table 10.4-1 lists the functional differences between ND, HD, HND, and HHD modes.

If the ND mode does not satisfy the requirements in your application in view of the overload capability and functionality, you need to select the inverter one or two ranks higher in capacity (HD/HND/HHD mode) than that of the motor rating.

To use the inverter under the ambient temperature or carrier frequency condition changed from the factory default, the output current rating requires derating due to the ambient temperature or carrier frequency. It is, therefore, necessary to select the inverter unit, referring to Figure 10.4-1 through Figure 10.4-4.

Table 10.4-1 Functional Differences between ND, HD, HND, and HHD Modes

Function	ND mode	HD mode	HND mode	HHD mode
Application	General load	Heavy duty load	General load	Heavy duty load
Data for function code F80	"4" (Factory default) *4	"3"	"1"	"0"
Continuous current rating level (inverter rated current level)	100% (Operating temperature: 40°C (104°F)) 80% (Operating temperature: 50°C (122°F)) (See Figure 10.4-1.)		100% (Operating temperature: 50°C (122°F))	
Overload capability	120% for 1 min.	150% 1 min.	120% 1 min.	150% for 1 min. 200% for 0.5 s
Maximum frequency *1	Setting range: 25 to 120 Hz Upper limit: 120Hz	Setting range: 25 to 500 Hz Upper limit: 500 Hz		
DC braking (Braking level) *1	Setting range: 0 to 60% (Based on the rated current level of ND-mode inverter)	Setting range: 0 to 80% (Based on the rated current level of HD-mode inverter)	Setting range: 0 to 80% (Based on the rated current level of HND-mode inverter)	Setting range: 0 to 100% (Based on the rated current level of HHD-mode inverter)
Motor sound (Carrier frequency) *1	Setting range: 0.75 to 10 kHz (FRN0002E2■-4□ to FRN0059E2■-4□) (FRN0012E2■-2□, FRN0020E2■-2□) 0.75 to 6 kHz (FRN0072E2■-4□ to FRN0590E2■-4□)	Setting range: 0.75 to 16 kHz (FRN0001E2■-2□ to FRN0088E2■-2□) (FRN0002E2■-4□ to FRN0059E2■-4□) 0.75 to 10 kHz (FRN0072E2■-4□ to FRN0168E2■-4□) (FRN0115E2■-2□) 0.75 to 6 kHz (FRN0203E2■-4□ to FRN0590E2■-4□)		Setting range: 0.75 to 16 kHz (FRN0001E2■-2□ to FRN0115E2■-2□) (FRN0002E2■-4□ to FRN0168E2■-4□) (FRN0001E2■-7□ to FRN0011E2■-7□) 0.75 to 10 kHz (FRN0203E2■-4□ to FRN0590E2■-4□)
Current limiter (Level) *2	Initial value: 130%	Initial value: 160%	Initial value: 130%	Initial value: 160% or 180% *3
Current indication and output	Based on the rated current level of ND-mode inverter	Based on the rated current level of HD-mode inverter	Based on the rated current level of HND-mode inverter	Based on the rated current level of HHD-mode inverter

Note: A box (■) in the above table replaces S: Standard or E: EMC filter built-in type.

A box (□) in the above table replaces GA, GB or C depending on the model.

- *1 In the ND/HD/HND mode, a setting value out of the range will be replaced with the upper limit of each mode.
- *2 Mode switching with function code F80 initializes the current limiter level.
- *3 FRN0011E2■-7□ / FRN0069E2■-2□ / FRN0044E2■-4□ or below is "180%", FRN0088E2■-2□ / FRN0059E2■-4□ or above is "160%".
- *4 FRN0011E2■-7□ or below is "0(HHD)", FRN0010E2■-2□ or below is "1(HND)".
FRN0030E2■-2□ or above is "1(HND)",

10.4 Selecting an Inverter Drive Mode (ND/HD/HND/HHD)

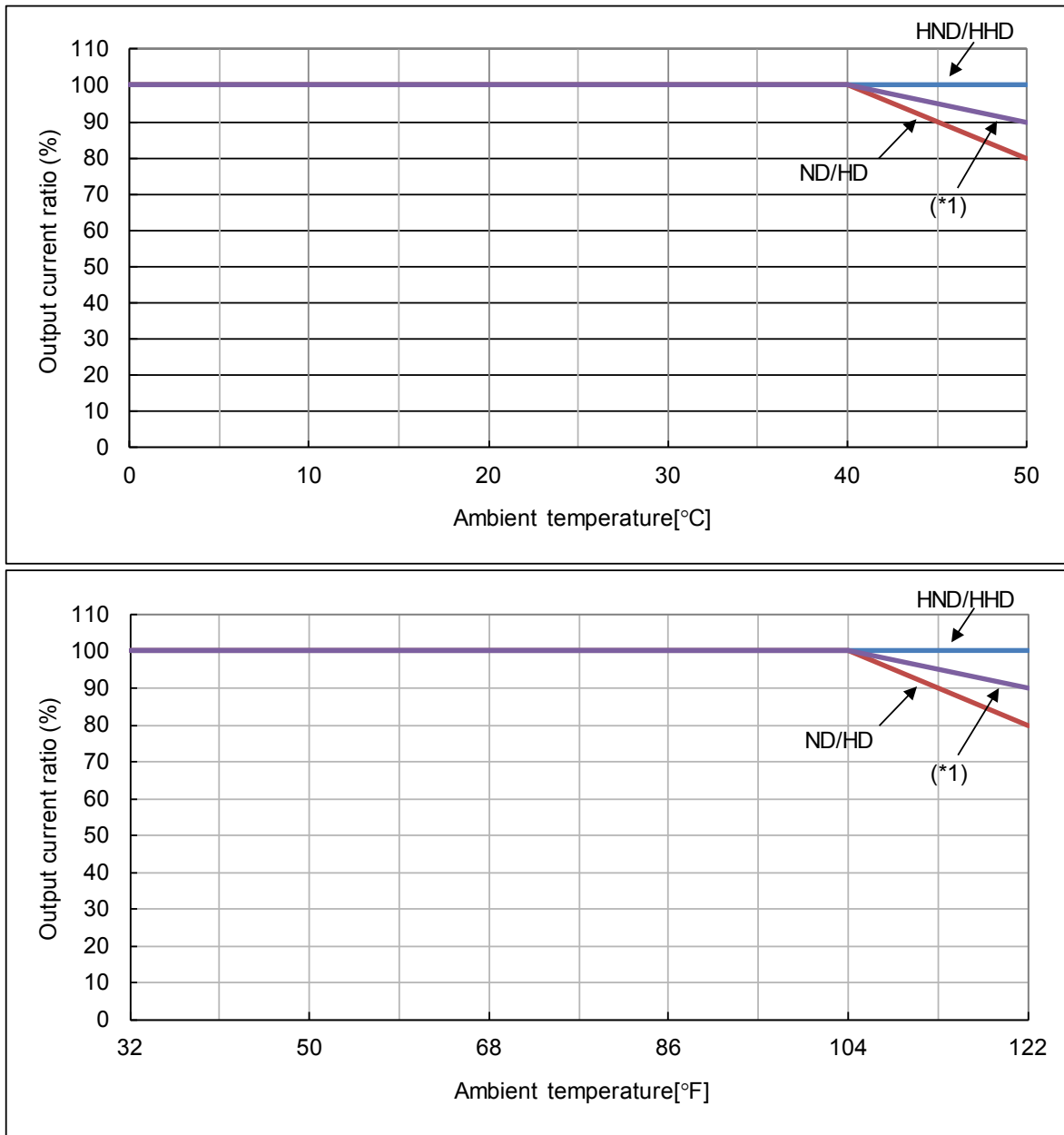

(*1) FRN0012/0020E2 ■-2□ and FRN0007/0012E2 ■-4□ at ND spec.

Figure 10.4-1 Derating of Output Current Due to Ambient Temperature

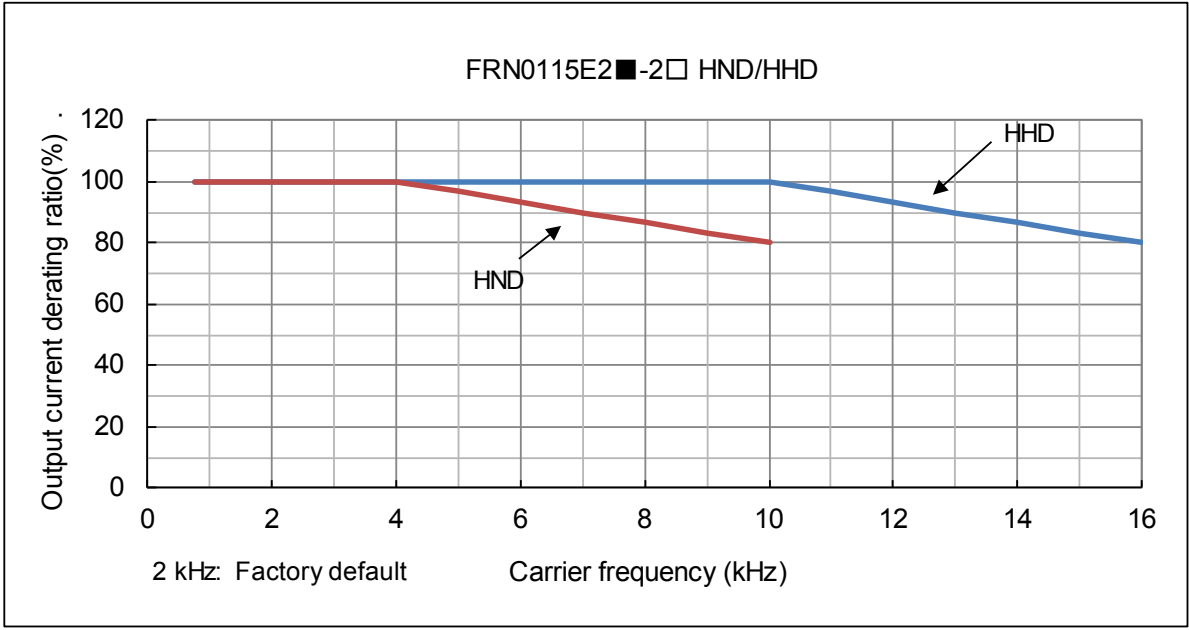
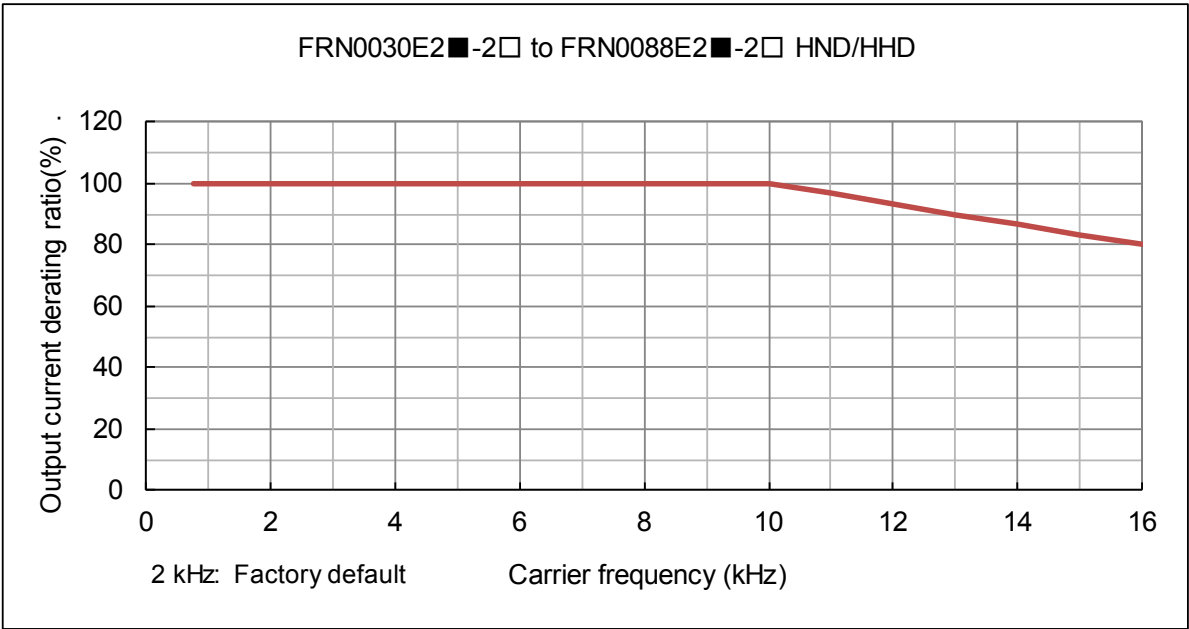
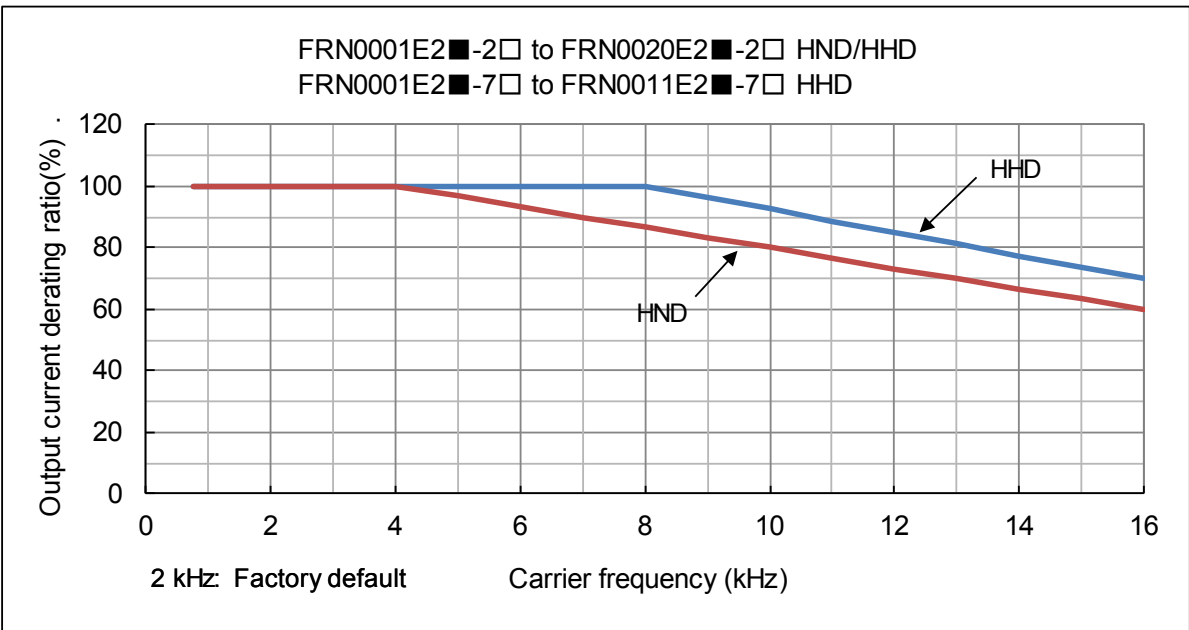

Figure 10.4-2 Derating of Output Current Due to Carrier Frequency

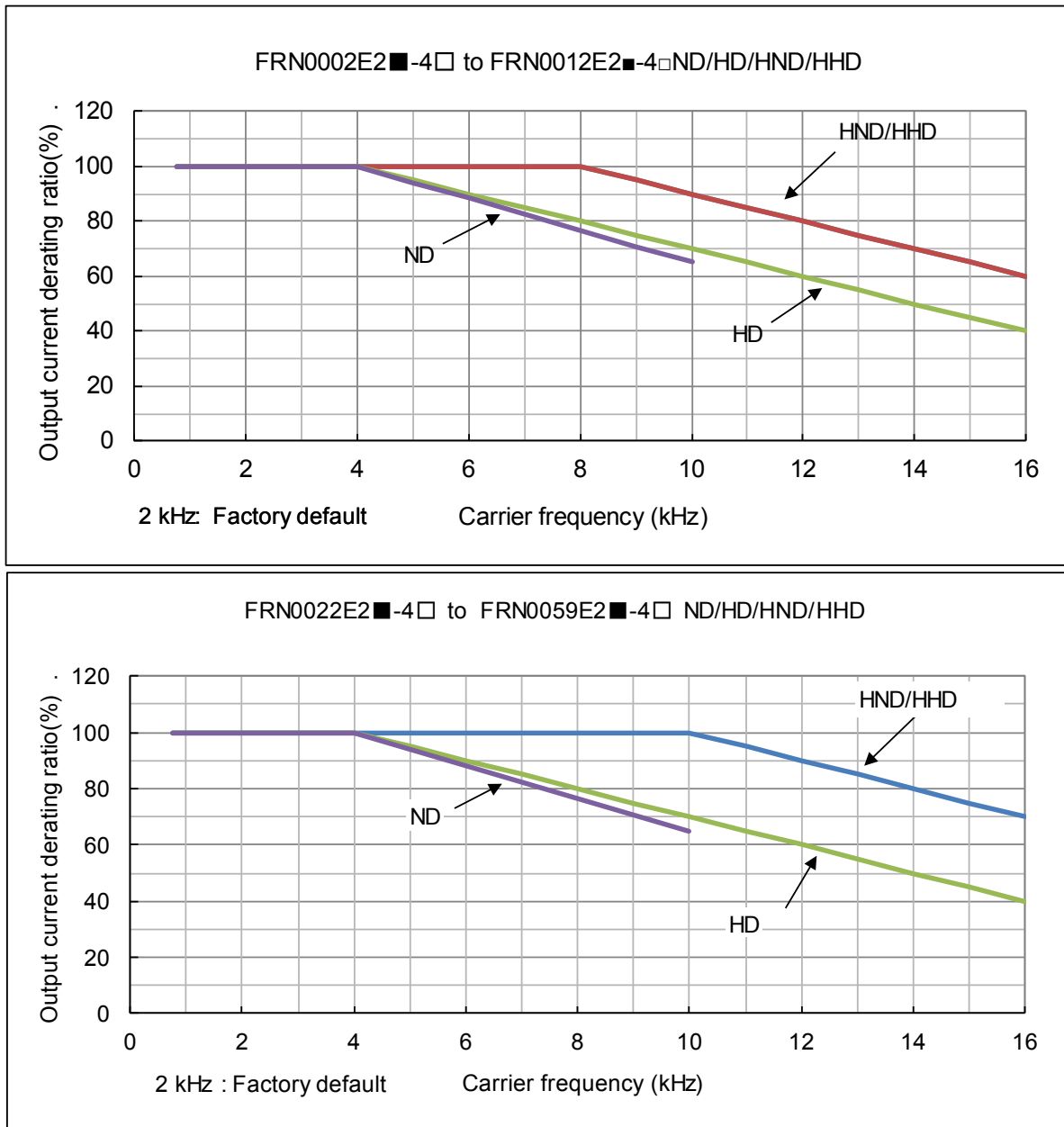

Figure 10.4-3 Derating of Output Current Due to Carrier Frequency

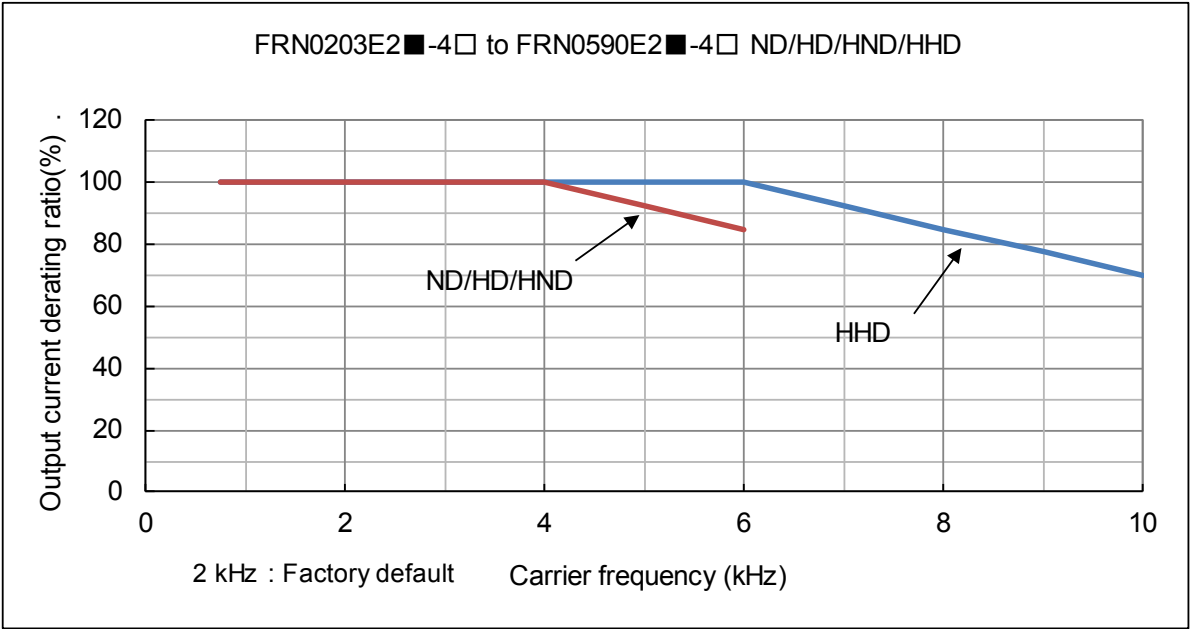
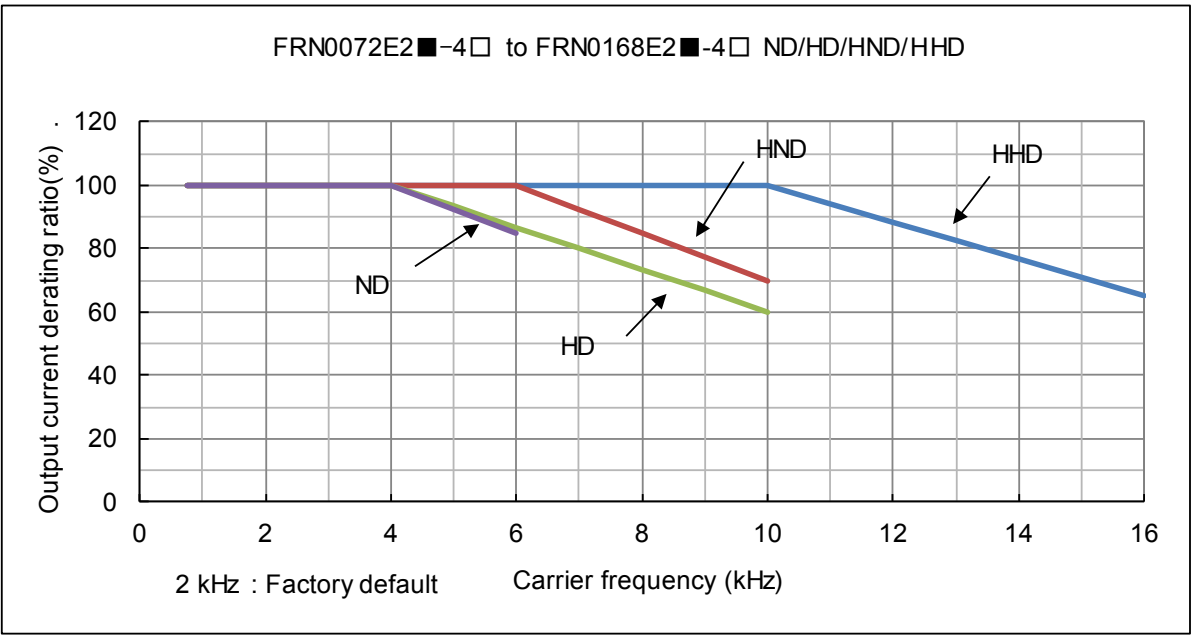

Figure 10.4-4 Derating of Output Current Due to Carrier Frequency

Chapter 11

SELECTING PERIPHERAL EQUIPMENT

This chapter describes how to use a range of peripheral equipment and options, FRENIC-Ace's configuration with them, and requirements and precautions for selecting wires and crimp terminals.

Contents

11.1	Configuring the FRENIC-Ace	11-1
11.2	Currents Flowing Across the Inverter Terminals	11-2
11.3	Molded Case Circuit Breaker (MCCB), Residual-current-operated Protective Device (RCD)/ Earth Leakage Circuit Breaker (ELCB) and Magnetic Contactor (MC)	11-8
11.3.1	Function overview	11-8
11.3.2	Connection example and criteria for selection of circuit breakers	11-9
11.4	Surge Killers for L-load	11-15
11.5	Arresters	11-16
11.6	Surge Absorbers	11-17
11.7	Filtering Capacitors Suppressing AM Radio Band Noises	11-18
11.8	Braking Resistors (DBRs) and Braking Units	11-19
11.8.1	Selecting a braking resistor	11-19
[1]	Selection procedure	11-19
[2]	Notes on selection	11-19
11.8.2	Braking resistors (DBRs)	11-20
[1]	Standard model	11-20
[2]	10%ED model	11-20
11.8.3	Braking units	11-21
11.8.4	Specifications	11-22
11.8.5	External dimensions	11-31
11.9	Power Regenerative PWM Converters, RHC Series	11-33
11.9.1	Overview	11-33
11.9.2	Specifications	11-34
[1]	Standard specifications	11-34
[2]	Common specifications	11-35
11.9.3	Function specifications	11-36
11.9.4	Converter configuration	11-40
11.9.5	External dimensions	11-42
11.10	DC Reactors (DCRs)	11-47
11.11	AC Reactors (ACRs)	11-51
11.12	Surge Suppression Unit (SSU)	11-55

11.13	Output Circuit Filters (OFLs)	11-56
11.14	Zero-phase Reactors for Reducing Radio Noise (ACLs)	11-58
11.15	External Cooling Fan Attachments	11-59
11.16	External Frequency Command Potentiometer	11-61
11.17	Extension Cable for Remote Operation	11-62
11.18	Frequency Meters	11-63
11.19	Options for communication and operation overview	11-64
11.19.1	Mounting adapter (for communication option card)	11-64
11.19.2	Communication option cards (required mounting adapter required)	11-64
11.19.3	Terminal block type options	11-65
11.19.4	Option keypad	11-65
11.20	DeviceNet communications card (OPC-DEV)	11-66
11.20.1	DeviceNet specifications	11-66
11.21	CC-Link communications card (OPC-CCL)	11-67
11.21.1	CC-Link specifications	11-67
11.22	Digital I/O interface card (OPC-DIO)	11-68
11.23	Analog interface card (OPC-AIO)	11-70
11.24	RS-485 communication card (OPC-E2-RS)	11-73
11.25	PG interface card (OPC-E2-PG3)	11-75
11.25.1	Interface specifications (feedback side, PG interface)	11-75
11.25.2	Interface specifications (command side, pulse train interface)	11-76
11.25.3	Constraints on standard control circuit terminal	11-76
11.25.4	Terminal functions	11-77
11.25.5	Connection diagram	11-77
11.25.6	Voltage selection switch / Power supply selection jumper	11-78
11.26	PG interface card (OPC-E2-PG)	11-79
11.26.1	Interface specifications (feedback side, PG interface)	11-79
11.26.2	Interface specifications (command side, pulse train interface)	11-79
11.26.3	Constraints on standard control circuit terminal	11-80
11.26.4	Terminal functions	11-80
11.26.5	Connection diagram	11-81
11.26.6	Power supply selection jumper	11-81
11.27	Simple keypad with USB port (TP-E1U)	11-82
11.28	Multi functional keypad (TP-A1-E2C)	11-83
11.29	FRENIC Visual Customizer	11-84
11.29.1	Overview	11-84
11.29.2	Specifications	11-84
11.29.3	Functions	11-84
11.29.4	Main Window	11-85

11.1 Configuring the FRENIC-Ace

This section lists the names and features of peripheral equipment and options for the FRENIC-Ace as well as a configuration example.

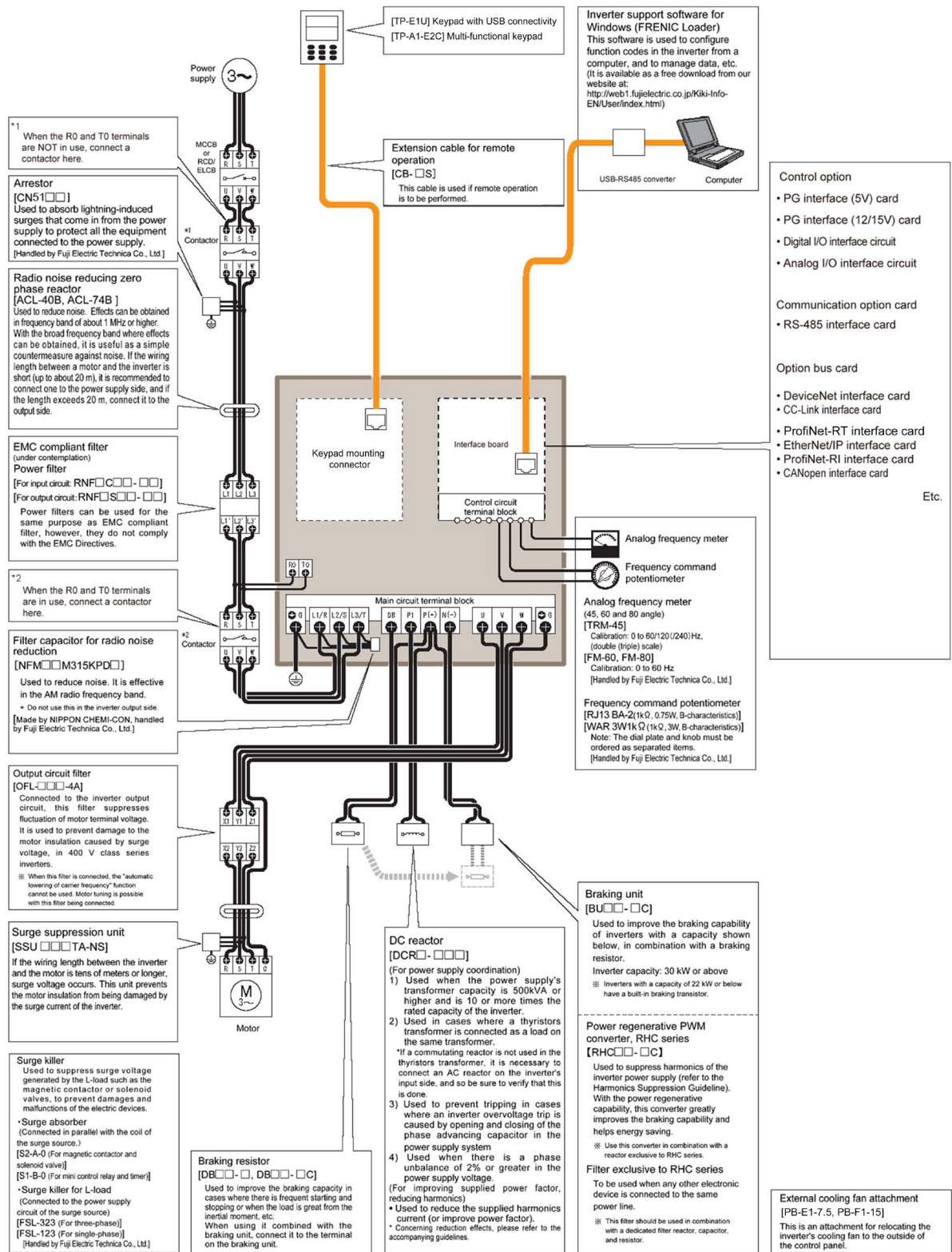

Figure 11.1-1 Quick Overview of Options

11.2 Currents Flowing Across the Inverter Terminals

Table 11.2-1 summarizes average (effective) electric currents flowing across the terminals of each inverter model for ease of reference when selecting peripheral equipment and options for each inverter—including supplied power voltage and applicable motor rating.

Table 11.2-1 Currents Flowing across the Inverter Terminals

ND mode (kW rating motor)

Power supply voltage	Nominal applied motor (kW)	Inverter type	50Hz, 400V			60Hz, 440V			Braking resistor circuit current (A)
			Input RMS current (A)		DC link bus current (A)	Input RMS current (A)		DC link bus current (A)	
			DC reactors (DCRs)			DC reactors (DCRs)			
			w/ DCR	w/o DCR	w/ DCR	w/o DCR			
Three-phase 400V/440V	0.75	FRN0002E2■-4□	1.5	2.7	1.8	1.4	2.7	1.7	0.80
	1.5	FRN0004E2■-4□	2.9	4.8	3.6	2.6	4.8	3.2	1.1
	2.2	FRN0006E2■-4□	4.2	7.3	5.1	3.8	7.1	4.7	1.8
	3.0	FRN0007E2■-4□	5.8	11.3	7.1	5.3	10.2	6.5	1.8
	5.5	FRN0012E2■-4□	10.1	16.8	12.4	9.1	15.7	11.1	2.1
	11	FRN0022E2■-4□	21.1	33.0	25.9	19.0	29.8	23.3	3.2
	15	FRN0029E2■-4□	28.8	43.8	35.3	26.0	39.5	31.9	3.1
	18.5	FRN0037E2■-4□	35.5	52.3	43.5	32.0	47.1	39.2	4.5
	22	FRN0044E2■-4□	42.2	60.6	51.7	38.0	54.6	46.6	5.7
	30	FRN0059E2■-4□	57.0	77.9	69.9	51.4	70.2	63.0	7.2
	37	FRN0072E2■-4□	68.5	94.3	83.9	61.8	85.0	75.7	7.7
	45	FRN0085E2■-4□	83.2	114	102	75.0	103	91.9	10
	55	FRN0105E2■-4□	102	140	125	91.9	126	113	12
	75	FRN0139E2■-4□	138	-	169	124	-	152	15
	90	FRN0168E2■-4□	164	-	201	148	-	181	19
	110	FRN0203E2■-4□	201	-	246	181	-	222	24
	132	FRN0240E2■-4□	238	-	292	214	-	263	31
	160	FRN0290E2■-4□	286	-	350	258	-	315	35
200	FRN0361E2■-4□	357	-	437	321	-	394	42	
220	FRN0415E2■-4□	390	-	478	351	-	430	50	
280	FRN0520E2■-4□	500	-	613	450	-	552	62	
315	FRN0590E2■-4□	559	-	685	503	-	617	71	

ND mode (HP rating motor)

Power supply voltage	Nominal applied motor (HP)	Inverter type	60Hz, 460V			Braking resistor circuit current (A)
			Input RMS current (A)		DC link bus current (A)	
			DC reactors (DCRs)			
			w/ DCR	w/o DCR		
Three-phase 460V	1	FRN0002E2■-4□	1.3	2.7	1.6	0.80
	2	FRN0004E2■-4□	2.5	4.7	3.1	1.1
	3	FRN0006E2■-4□	3.6	7.0	4.4	1.8
	4	FRN0007E2■-4□	5.0	9.8	6.1	1.8
	7.5	FRN0012E2■-4□	8.9	15.0	10.9	2.1
	15	FRN0022E2■-4□	18.8	28.6	23.0	3.2
	20	FRN0029E2■-4□	25.1	38.0	30.7	3.1
	25	FRN0037E2■-4□	31.3	45.4	38.3	4.5
	30	FRN0044E2■-4□	36.3	52.6	44.5	5.7
	40	FRN0059E2■-4□	50.2	67.7	61.5	7.2
	50	FRN0072E2■-4□	60.2	82.0	73.7	7.7
	60	FRN0085E2■-4□	72.7	99.1	89.0	10
	75	FRN0105E2■-4□	89.1	121	109	12
	100	FRN0139E2■-4□	120	-	147	15
	125	FRN0168E2■-4□	143	-	175	19
	150	FRN0203E2■-4□	175	-	214	24
	200	FRN0240E2■-4□	207	-	254	31
	250	-	-	-	-	-
300	FRN0361E2■-4□	311	-	381	42	
350	FRN0415E2■-4□	340	-	416	50	
400	-	-	-	-	-	
450	FRN0520E2■-4□	435	-	533	62	
500	FRN0590E2■-4□	547	-	670	71	

Note: A box (■) in the above table replaces S (Basic type) or E (EMC filter built-in type) depending on the enclosure. A box (□) in the above table replaces GA, GB or C depending on the model.

- Inverter efficiency is calculated using values suitable for each inverter model. The input route mean square current is calculated based on a power supply capacity of 500 kVA (or 10 times as large as the inverter’s capacity when the inverter’s capacity exceeds 50 kVA), and a power supply reactance of 5%.
- The input RMS current listed in the above table will vary in inverse proportion to the power supply voltage, such as 480 VAC.
- The braking current is always constant, independent of braking resistor specifications, including standard and 10%ED models.

11.2 Currents Flowing Across the Inverter Terminals

Table 11.2-1 Currents Flowing across the Inverter Terminals (continued)

HD mode (kW rating motor)

Power supply voltage	Nominal applied motor (kW)	Inverter type	50Hz, 400V			60Hz, 440V			Braking resistor circuit current (A)
			Input RMS current (A)		DC link bus current (A)	Input RMS current (A)		DC link bus current (A)	
			DC reactors (DCRs)			DC reactors (DCRs)			
			w/ DCR	w/o DCR	w/ DCR	w/o DCR			
Three-phase 400V/440V	0.75	FRN0002E2■-4□	1.5	2.7	1.8	1.4	2.7	1.7	0.80
	1.1	FRN0004E2■-4□	2.1	3.9	2.6	1.9	3.9	2.3	1.1
	2.2	FRN0006E2■-4□	4.2	7.3	5.1	3.8	7.1	4.6	1.8
	3.0	FRN0007E2■-4□	5.8	11.3	7.1	5.3	10.2	6.5	1.8
	5.5	FRN0012E2■-4□	10.1	16.8	12.4	9.1	15.7	11.1	2.1
	7.5	FRN0022E2■-4□	14.4	23.2	17.7	13.0	21.0	16.0	3.2
	11	FRN0029E2■-4□	21.1	33.0	25.9	19.0	29.8	23.3	3.1
	15	FRN0037E2■-4□	28.8	43.8	35.3	26.0	39.5	31.9	4.5
	18.5	FRN0044E2■-4□	35.5	52.3	43.5	32.0	47.1	39.2	5.7
	22	FRN0059E2■-4□	42.2	60.6	51.7	38.0	54.6	46.6	7.2
	30	FRN0072E2■-4□	57.0	77.9	69.9	51.4	70.2	63.0	7.7
	37	FRN0085E2■-4□	68.5	94.3	83.9	61.8	85.0	75.7	10
	45	FRN0105E2■-4□	83.2	114	102	75.0	103	91.9	12
	55	FRN0139E2■-4□	102	140	125	91.9	126	113	15
	75	FRN0168E2■-4□	138	-	169	124	-	152	19
	90	FRN0203E2■-4□	164	-	201	148	-	181	24
	110	FRN0240E2■-4□	201	-	246	181	-	222	31
	132	FRN0290E2■-4□	238	-	292	214	-	263	35
160	FRN0361E2■-4□	286	-	350	258	-	315	42	
200	FRN0415E2■-4□	357	-	437	321	-	394	50	
220	FRN0520E2■-4□	390	-	478	351	-	430	62	
250	FRN0590E2■-4□	443	-	543	399	-	489	71	

HD mode (HP rating motor)

Power supply voltage	Nominal applied motor (HP)	Inverter type	60Hz, 460V			Braking resistor circuit current (A)
			Input RMS current (A)		DC link bus current (A)	
			DC reactors (DCRs)			
			w/ DCR	w/o DCR		
Three-phase 460V	1	FRN0002E2■-4□	1.3	2.7	1.6	0.80
	1.5	FRN0004E2■-4□	1.8	3.8	2.2	1.1
	3	FRN0006E2■-4□	3.6	7.0	4.4	1.8
	4	FRN0007E2■-4□	5.0	9.8	6.1	1.8
	7.5	FRN0012E2■-4□	8.9	15.0	10.9	2.1
	10	FRN0022E2■-4□	12.5	20.1	15.3	3.2
	15	FRN0029E2■-4□	18.8	28.6	23.0	3.1
	20	FRN0037E2■-4□	25.1	38.0	30.7	4.5
	25	FRN0044E2■-4□	31.3	45.4	38.3	5.7
	30	FRN0059E2■-4□	36.3	52.6	44.5	7.2
	40	FRN0072E2■-4□	50.2	67.7	61.5	7.7
	50	FRN0085E2■-4□	60.2	82.0	73.7	10
	60	FRN0105E2■-4□	72.7	99.1	89.0	12
	75	FRN0139E2■-4□	89.1	121	109	15
	100	FRN0168E2■-4□	120	-	147	19
	125	FRN0203E2■-4□	143	-	175	24
	150	FRN0240E2■-4□	175	-	214	31
	200	FRN0290E2■-4□	207	-	254	35
250	FRN0361E2■-4□	249	-	305	42	
300	FRN0415E2■-4□	311	-	381	50	
350	FRN0520E2■-4□	340	-	416	62	
400	FRN0590E2■-4□	436	-	534	71	

Note: A box (■) in the above table replaces S (Basic type) or E (EMC filter built-in type) depending on the enclosure. A box (□) in the above table replaces GA, GB or C depending on the model.

- Inverter efficiency is calculated using values suitable for each inverter model. The input route mean square current is calculated based on a power supply capacity of 500 kVA (or 10 times as large as the inverter's capacity when the inverter's capacity exceeds 50 kVA), and a power supply reactance of 5%.
- The input RMS current listed in the above table will vary in inverse proportion to the power supply voltage, such as 480 VAC.
- The braking current is always constant, independent of braking resistor specifications, including standard and 10%ED models.

11.2 Currents Flowing Across the Inverter Terminals

Table 11.2-1 Currents Flowing across the Inverter Terminals (continued)

HND mode (kW rating motor)

Power supply voltage	Nominal applied motor (kW)	Inverter type	50Hz, 200V/400V			60Hz, 220V/440V			Braking resistor circuit current (A)
			Input RMS current (A)		DC link bus current (A)	Input RMS current (A)		DC link bus current (A)	
			DC reactors (DCRs)			DC reactors (DCRs)			
			w/ DCR	w/o DCR	w/ DCR	w/o DCR			
Three-phase 200V/220V	0.2	FRN0001E2-2□	0.93	1.8	1.1	0.85	1.7	1.0	0.82
	0.4	FRN0002E2-2□	1.6	2.6	2.0	1.5	2.6	1.8	1.2
	0.75	FRN0004E2-2□	3.0	4.9	3.7	2.8	4.9	3.4	1.2
	1.1	FRN0006E2-2□	4.3	6.7	5.3	5.2	6.7	6.4	1.6
	2.2	FRN0010E2-2□	8.3	12.8	10.2	7.6	12.3	9.3	3.6
	3.0	FRN0012E2-2□	11.7	17.9	14.3	12.7	17.9	15.6	3.5
	5.5	FRN0020E2-2□	19.9	28.5	24.4	19	28.4	23.3	4.1
	7.5	FRN0030E2-2□	28.8	42.7	35.3	26.0	38.5	31.9	6.4
	11	FRN0040E2-2□	42.2	60.7	51.7	38.0	54.7	46.6	6.1
	15	FRN0056E2-2□	57.6	80.0	70.6	52.0	72.2	63.7	9.1
	18.5	FRN0069E2-2□	71.0	97.0	87.0	64.0	87.4	78.4	11.0
	22	FRN0088E2-2□	84.4	112	103	76.0	101	93.1	14
	30	FRN0115E2-2□	114	151	140	103	136	126	15
Three-phase 400V/440V	0.75	FRN0002E2-4□	1.5	2.7	1.8	1.4	2.7	1.7	0.80
	1.1	FRN0004E2-4□	2.1	3.9	2.6	1.9	3.9	2.3	1.1
	2.2	FRN0006E2-4□	4.2	7.3	5.1	3.8	7.1	4.7	1.8
	3.0	FRN0007E2-4□	5.8	11.3	7.1	5.3	10.2	6.5	1.8
	5.5	FRN0012E2-4□	10.1	16.8	12.4	9.1	15.7	11.1	2.1
	7.5	FRN0022E2-4□	14.4	23.2	17.7	13.0	21.0	16.0	3.2
	11	FRN0029E2-4□	21.1	33.0	25.9	19.0	29.8	23.3	3.1
	15	FRN0037E2-4□	28.8	43.8	35.3	26.0	39.5	31.9	4.5
	18.5	FRN0044E2-4□	35.5	52.3	43.5	32.0	47.1	39.2	5.7
	22	FRN0059E2-4□	42.2	60.6	51.7	38.0	54.6	46.6	7.2
	30	FRN0072E2-4□	57.0	77.9	69.9	51.4	70.2	63.0	7.7
	37	FRN0085E2-4□	68.5	94.3	83.9	61.8	85.0	75.7	10
	45	FRN0105E2-4□	83.2	114	102	75.0	103	91.9	12
	55	FRN0139E2-4□	102	140	125	91.9	126	113	15
	75	FRN0168E2-4□	138	-	169	124	-	152	19
	90	FRN0203E2-4□	164	-	201	148	-	181	24
	110	FRN0240E2-4□	201	-	246	181	-	222	31
	132	FRN0290E2-4□	238	-	292	214	-	263	35
160	FRN0361E2-4□	286	-	350	258	-	315	42	
200	FRN0415E2-4□	357	-	437	321	-	394	50	
220	FRN0520E2-4□	390	-	478	351	-	430	62	
280	FRN0590E2-4□	500	-	613	450	-	552	71	

Note: A box (■) in the above table replaces S (Basic type) or E (EMC filter built-in type) depending on the enclosure.
A box (□) in the above table replaces GA, GB or C depending on the model.

- Inverter efficiency is calculated using values suitable for each inverter model. The input route mean square current is calculated based on a power supply capacity of 500 kVA (or 10 times as large as the inverter's capacity when the inverter's capacity exceeds 50 kVA), and a power supply reactance of 5%.
- The input RMS current listed in the above table will vary in inverse proportion to the power supply voltage, such as 480 VAC.
- The braking current is always constant, independent of braking resistor specifications, including standard and 10%ED models.

Table 11.2-1 Currents Flowing across the Inverter Terminals (continued)

HND mode (HP rating motor)

Power supply voltage	Nominal applied motor (HP)	Inverter type	60Hz, 230V/460V			Braking resistor circuit current (A)
			Input RMS current (A)		DC link bus current (A)	
			DC reactors (DCRs)			
			w/ DCR	w/o DCR		
Three-phase 230V	1/4	FRN0001E2■-2□	0.83	1.7	1.0	0.82
	1/2	FRN0002E2■-2□	1.4	2.5	1.7	1.2
	1	FRN0004E2■-2□	2.7	4.8	3.3	1.2
	1.5	FRN0006E2■-2□	3.8	6.5	4.7	1.6
	3	FRN0010E2■-2□	7.3	12	8.9	3.6
	4	FRN0012E2■-2□	10.2	17.6	12.5	3.5
	7.5	FRN0020E2■-2□	17.4	27.4	21.3	4.1
	10	FRN0030E2■-2□	25.1	38.6	30.7	6.4
	15	FRN0040E2■-2□	37.6	54.8	46.1	6.1
	20	FRN0056E2■-2□	50.2	72.4	61.5	9.1
	25	FRN0069E2■-2□	62.7	87.7	76.8	11.0
30	FRN0088E2■-2□	72.5	96.4	88.8	14	
40	FRN0115E2■-2□	99.2	130	121.5	15	
Three-phase 460V	1	FRN0002E2■-4□	1.3	2.7	1.6	0.80
	1.5	FRN0004E2■-4□	1.8	3.8	2.2	1.1
	3	FRN0006E2■-4□	3.6	7.0	4.4	1.8
	4	FRN0007E2■-4□	5.0	9.8	6.1	1.8
	7.5	FRN0012E2■-4□	8.9	15.0	10.9	2.1
	10	FRN0022E2■-4□	12.5	20.1	15.3	3.2
	15	FRN0029E2■-4□	18.8	28.6	23.0	3.1
	20	FRN0037E2■-4□	25.1	38.0	30.7	4.5
	25	FRN0044E2■-4□	31.3	45.4	38.3	5.7
	30	FRN0059E2■-4□	36.3	52.6	44.5	7.2
	40	FRN0072E2■-4□	50.2	67.7	61.5	7.7
	50	FRN0085E2■-4□	60.2	82.0	73.7	10
	60	FRN0105E2■-4□	72.7	99.1	89.0	12
	75	FRN0139E2■-4□	89.1	121	109	15
	100	FRN0168E2■-4□	120	-	147	19
	125	FRN0203E2■-4□	143	-	175	24
	150	FRN0240E2■-4□	175	-	214	31
	200	FRN0290E2■-4□	207	-	254	35
250	FRN0361E2■-4□	249	-	305	42	
300	FRN0415E2■-4□	311	-	381	50	
350	FRN0520E2■-4□	340	-	416	62	
400	-	-	-	-	-	
450	FRN0590E2■-4□	486	-	595	71	

Note: A box (■) in the above table replaces S (Basic type) or E (EMC filter built-in type) depending on the enclosure. A box (□) in the above table replaces GA, GB or C depending on the model.

- Inverter efficiency is calculated using values suitable for each inverter model. The input route mean square current is calculated based on a power supply capacity of 500 kVA (or 10 times as large as the inverter's capacity when the inverter's capacity exceeds 50 kVA), and a power supply reactance of 5%.
- The input RMS current listed in the above table will vary in inverse proportion to the power supply voltage, such as 480 VAC.
- The braking current is always constant, independent of braking resistor specifications, including standard and 10%ED models.

11.2 Currents Flowing Across the Inverter Terminals

Table 11.2-1 Currents Flowing across the Inverter Terminals (continued)

HHD mode (kW rating motor)

Power supply voltage	Nominal applied motor (kW)	Inverter type	50Hz, 200V/400V			60Hz, 220V/440V			Braking resistor circuit current (A)
			Input RMS current (A)		DC link bus current (A)	Input RMS current (A)		DC link bus current (A)	
			DC reactors (DCRs)			DC reactors (DCRs)			
			w/ DCR	w/o DCR		w/ DCR	w/o DCR		
Three-phase 200V/220V	0.1	FRN0001E2■-2□	0.57	1.1	0.70	0.51	1.1	0.62	0.82
	0.2	FRN0002E2■-2□	0.93	1.8	1.1	0.85	1.7	1.0	1.2
	0.4	FRN0004E2■-2□	1.6	3.1	2.0	1.5	3.0	1.8	1.2
	0.75	FRN0006E2■-2□	3.0	5.3	3.7	2.8	5.0	3.4	1.6
	1.5	FRN0010E2■-2□	5.7	9.5	7.0	5.2	9.0	6.3	3.6
	2.2	FRN0012E2■-2□	8.3	13.2	10.2	7.6	12.3	9.3	3.5
	3.7	FRN0020E2■-2□	14.0	22.2	17.2	12.7	20.6	15.6	4.1
	5.5	FRN0030E2■-2□	21.1	31.5	25.9	19.0	28.4	23.3	6.4
	7.5	FRN0040E2■-2□	28.8	42.7	35.3	26.0	38.5	31.9	6.1
	11	FRN0056E2■-2□	42.2	60.7	51.7	38.0	54.7	46.6	9.1
	15	FRN0069E2■-2□	57.6	80.0	70.6	52.0	72.2	63.7	11
18.5	FRN0088E2■-2□	71.0	97.0	87.0	64.0	87.4	78.4	14	
22	FRN0115E2■-2□	84.4	112	103	76.0	101	93.1	15	
Three-phase 400V/440V	0.4	FRN0002E2■-4□	0.85	1.7	1.0	0.74	1.7	0.99	0.80
	0.75	FRN0004E2■-4□	1.6	3.1	1.8	1.4	3.0	1.7	1.1
	1.5	FRN0006E2■-4□	3.0	5.9	3.5	2.6	5.1	3.2	1.8
	2.2	FRN0007E2■-4□	4.4	8.2	5.1	3.8	7.1	4.6	1.8
	3.7	FRN0012E2■-4□	7.3	13.0	8.6	6.4	11.1	7.8	2.1
	5.5	FRN0022E2■-4□	10.6	17.3	13.0	9.6	15.7	11.8	3.2
	7.5	FRN0029E2■-4□	14.4	23.2	17.7	13.0	21.0	16.0	3.1
	11	FRN0037E2■-4□	21.1	33.0	25.9	19.0	29.8	23.3	4.5
	15	FRN0044E2■-4□	28.8	43.8	35.3	26.0	39.5	31.9	5.7
	18.5	FRN0059E2■-4□	35.5	52.3	43.5	32.0	47.1	39.2	7.2
	22	FRN0072E2■-4□	42.2	60.6	51.7	38.0	54.6	46.6	7.7
	30	FRN0085E2■-4□	57.0	77.9	69.9	51.4	70.2	63.0	10
	37	FRN0105E2■-4□	68.5	94.3	83.9	61.8	85.0	75.7	12
	45	FRN0139E2■-4□	83.2	114	102	75.0	103	91.9	15
	55	FRN0168E2■-4□	102	140	125	91.9	126	113	19
	75	FRN0203E2■-4□	138	-	169	124	-	152	24
	90	FRN0240E2■-4□	164	-	201	148	-	181	31
	110	FRN0290E2■-4□	201	-	246	181	-	222	35
132	FRN0361E2■-4□	238	-	292	214	-	263	42	
160	FRN0415E2■-4□	286	-	350	258	-	315	50	
200	FRN0520E2■-4□	357	-	437	321	-	394	62	
220	FRN0590E2■-4□	390	-	478	351	-	430	71	
Single-phase 200V	0.1	FRN0001E2■-7□	1.1	1.8	1.1	1.0	1.8	1.0	0.61
	0.2	FRN0002E2■-7□	2.0	3.3	2.0	1.8	3.1	1.8	0.66
	0.4	FRN0003E2■-7□	3.5	5.4	3.5	3.1	5.0	3.1	0.82
	0.75	FRN0005E2■-7□	6.4	9.7	6.4	5.8	9.1	5.8	1.4
	1.5	FRN0008E2■-7□	11.6	16.4	12	10.5	15.5	10.5	1.4
	2.2	FRN0011E2■-7□	17.5	24.8	18	15.8	23.4	15.8	1.7

Note: A box (■) in the above table replaces S (Basic type) or E (EMC filter built-in type) depending on the enclosure. A box (□) in the above table replaces GA, GB or C depending on the model.

- Inverter efficiency is calculated using values suitable for each inverter model. The input route mean square current is calculated based on a power supply capacity of 500 kVA (or 10 times as large as the inverter's capacity when the inverter's capacity exceeds 50 kVA), and a power supply reactance of 5%.
- The input RMS current listed in the above table will vary in inverse proportion to the power supply voltage, such as 480 VAC.
- The braking current is always constant, independent of braking resistor specifications, including standard and 10%ED models.

Table 11.2-1 Currents Flowing across the Inverter Terminals (continued)

HHD mode (HP rating motor)

Power supply voltage	Nominal applied motor (HP)	Inverter type	60Hz, 230V/460V			Braking resistor circuit current (A)
			Input RMS current (A)		DC link bus current (A)	
			DC reactors (DCRs)			
			w/ DCR	w/o DCR		
Three-phase 230V	1/8	FRN0001E2-2□	0.49	1.1	0.60	0.82
	1/4	FRN0002E2-2□	0.82	1.7	1.0	1.2
	1/2	FRN0004E2-2□	1.4	3.0	1.7	1.2
	1	FRN0006E2-2□	2.7	4.9	3.3	1.6
	2	FRN0010E2-2□	5.0	8.8	6.1	3.6
	3	FRN0012E2-2□	7.3	12.0	8.9	3.5
	5	FRN0020E2-2□	12.4	20.0	15.2	4.1
	7.5	FRN0030E2-2□	18.5	28.4	22.7	6.4
	10	FRN0040E2-2□	25.1	38.6	30.7	6.1
	15	FRN0056E2-2□	37.6	54.8	46.1	9.1
	20	FRN0069E2-2□	50.2	72.4	61.5	11.0
Three-phase 460V	25	FRN0088E2-2□	62.7	87.7	76.8	14
	30	FRN0115E2-2□	72.5	96.4	88.8	15
	1/2	FRN0002E2-4□	0.72	1.7	0.90	0.80
	1	FRN0004E2-4□	1.3	3.0	1.6	1.1
	2	FRN0006E2-4□	2.5	4.9	3.1	1.8
	3	FRN0007E2-4□	3.6	7.0	4.4	1.8
	5	FRN0012E2-4□	6.1	10.7	7.5	2.1
	7.5	FRN0022E2-4□	9.2	15.0	11.3	3.2
	10	FRN0029E2-4□	12.5	20.1	15.3	3.1
	15	FRN0037E2-4□	18.8	28.6	23.0	4.5
	20	FRN0044E2-4□	25.1	38.0	30.7	5.7
	25	FRN0059E2-4□	31.3	45.4	38.3	7.2
	30	FRN0072E2-4□	36.3	52.6	44.5	7.7
	40	FRN0085E2-4□	50.2	67.7	61.5	10
	50	FRN0105E2-4□	60.2	82.0	73.7	12
	60	FRN0139E2-4□	72.7	99.1	89.0	15
	75	FRN0168E2-4□	89.1	121	109	19
	Single-phase 200V	100	FRN0203E2-4□	120	-	147
125		FRN0240E2-4□	143	-	175	31
150		FRN0290E2-4□	175	-	214	35
200		FRN0361E2-4□	207	-	254	42
250		FRN0415E2-4□	249	-	305	50
300		FRN0520E2-4□	311	-	381	62
350		FRN0590E2-4□	340	-	416	71
1/8		FRN0001E2-7□	1.0	1.7	1.0	0.61
1/4		FRN0002E2-7□	1.7	2.7	1.7	0.66
1/2		FRN0003E2-7□	3.0	5.0	3.0	0.82
1	FRN0005E2-7□	5.7	8.9	5.7	1.4	
2	FRN0008E2-7□	10.2	15.0	10.2	1.4	
3	FRN0011E2-7□	15.7	23.0	15.7	1.7	

Note: A box (■) in the above table replaces S (Basic type) or E (EMC filter built-in type) depending on the enclosure. A box (□) in the above table replaces GA, GB or C depending on the model.

- Inverter efficiency is calculated using values suitable for each inverter model. The input route mean square current is calculated based on a power supply capacity of 500 kVA (or 10 times as large as the inverter's capacity when the inverter's capacity exceeds 50 kVA), and a power supply reactance of 5%.
- The input RMS current listed in the above table will vary in inverse proportion to the power supply voltage, such as 480 VAC.
- The braking current is always constant, independent of braking resistor specifications, including standard and 10%ED models.

11.3 Molded Case Circuit Breaker (MCCB), Residual-current-operated Protective Device (RCD)/Earth Leakage Circuit Breaker (ELCB) and Magnetic Contactor (MC)

11.3.1 Function overview

■ MCCBs and RCDs/ELCBs*

* With overcurrent protection

Molded Case Circuit Breakers (MCCBs) are designed to protect the power circuits between the power supply and inverter's main circuit terminals ([L1/R], [L2/S] and [L3/T]) from overload or short-circuit, which in turn prevents secondary accidents caused by the broken inverter.

Residual-Current-Operated Protective Devices (RCDs)/Earth Leakage Circuit Breakers (ELCBs) function in the same way as MCCBs.

Built-in overcurrent/overload protective functions protect the inverter itself from failures related to its input/output lines.

■ Magnetic contactor

An MC can be used at both the power input and output sides of the inverter. At each side, the MC works as described below. Use it as necessary. When inserted in the output circuit of the inverter, the MC can also switch the motor drive power supply between the inverter output and commercial power lines.

At the power supply side

Insert an MC in the power supply side of the inverter in order to:

- (1) Forcibly cut off the inverter from the power supply (generally, commercial/factory power lines) with the protective function built into the inverter, or with the external signal input.
- (2) Stop the inverter operation in an emergency when the inverter cannot interpret the stop command due to internal/external circuit failures.
- (3) Cut off the inverter from the power supply when the MCCB inserted in the power supply side cannot cut it off for maintenance or inspection purpose. For the purpose only, it is recommended that you use an MC capable of turning the MC ON/OFF manually.



Avoid frequent ON/OFF operation of the magnetic contactor (MC) in the input (primary) circuit; otherwise, the inverter failure may result.

The frequency of the MC's ON/OFF should not be more than once per 30 minutes. To assure 10-year or longer service life of the inverter, it should not be more than once per hour.

If frequent start/stop of the motor is required, use FWD/REV terminal signals or the  keys on the inverter's keypad.

At the output side

Insert an MC in the power output side of the inverter in order to:

- (1) Prevent externally turned-around current from being applied to the inverter power output terminals ([U], [V], and [W]) unexpectedly. An MC should be used, for example, when a circuit that switches the motor driving power supply between the inverter output and commercial power lines is connected to the inverter.



If a magnetic contactor (MC) is inserted in the inverter's output (secondary) circuit for switching the motor to a commercial power or for any other purposes, it should be switched on and off when both the inverter and motor are completely stopped. This prevents the contact point from getting rough due to a switching arc of the MC. The MC should not be equipped with any main circuit surge killer (Fuji SZ-ZM□, etc.).

Applying a commercial power to the inverter's output circuit breaks the inverter. To avoid it, interlock the MC on the motor's commercial power line with the one in the inverter output circuit so that they are not switched ON at the same time.

- (2) Drive more than one motor selectively by a single inverter.
- (3) Selectively cut off the motor whose thermal overload relay or equivalent devices have been activated.

Driving the motor using commercial power lines

MCs can also be used to switch the power supply of the motor driven by the inverter to a commercial power supply. Select the MC so as to satisfy the rated currents listed in Table 11.2-1, which are the most critical RMS currents for using the inverter (Refer to Table 11.3-1). For switching the motor drive source between the inverter output and commercial power lines, use the MC of class AC3 specified by JIS C8325 in the commercial line side.

11.3.2 Connection example and criteria for selection of circuit breakers

Figure 11.3-1 shows a connection example for MCCB or RCD/ELCB (with overcurrent protection) and MC in the inverter input circuit. Table 11.3-1 lists the rated current for the MCCB and corresponding inverter models. Table 11.3-2 lists the applicable grades of RCD/ELCB sensitivity.

⚠ WARNING

Insert an MCCB or RCD/ELCB (with overcurrent protection) recommended for each inverter for its input circuits. Do not use an MCCB or RCD/ELCB of a higher rating than that recommended. **Doing so could result in a fire.**

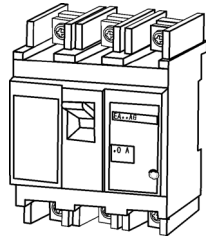

Molded case circuit breaker or residual-current-operated protective device/ earth leakage circuit breaker

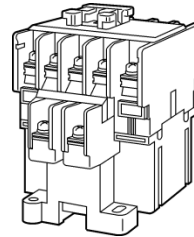

Magnetic contactor

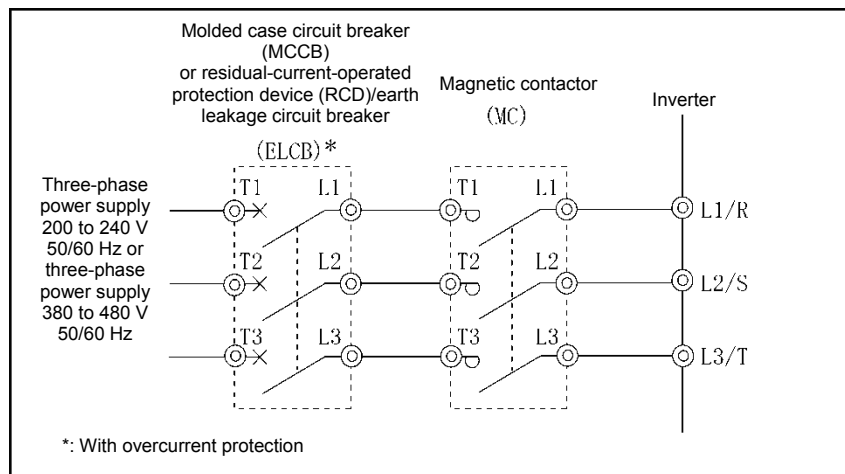

Figure 11.3-1 External Views of MCCB or RCD/ELCB and MC and Connection Example

11.3 Molded Case Circuit Breaker (MCCB), Residual-current-operated Protective Device (RCD)/Earth Leakage Circuit Breaker (ELCB) and Magnetic Contactor (MC)

Table 11.3-1 Rated Current of Molded Case Circuit Breaker (MCCB), Residual-Current-Operated Protective Device (RCD)/ Earth Leakage Circuit Breaker (ELCB) and Magnetic Contactor (MC)

ND mode (kW rating motor)

Power supply voltage	Nominal applied motor (kW)	Inverter type	MCCB, RCD/ELCB rated current (A)		Magnetic contactor (MC)		
			DC reactors (DCRs)		Input circuit		Output circuit
			w/ DCR	w/o DCR	DC reactors (DCRs)	DC reactors (DCRs)	
Three-phase 400V	0.75	FRN0002E2■-4□	5	5	SC-05	SC-05	SC-05
	1.5	FRN0004E2■-4□		10			
	2.2	FRN0006E2■-4□	10	15	SC-05	SC-05	SC-05
	3.0	FRN0007E2■-4□		30			
	5.5	FRN0012E2■-4□	15	30	SC-4-0	SC-N1	SC-4-0
	11	FRN0022E2■-4□	30	50			SC-5-1
	15	FRN0029E2■-4□	40	60	SC-N1	SC-N2	SC-N1
	18.5	FRN0037E2■-4□		75			
	22	FRN0044E2■-4□	50	100	SC-N2	SC-N2S	SC-N2
	30	FRN0059E2■-4□	75	125			
	37	FRN0072E2■-4□	100	125	SC-N2S	SC-N3	SC-N2S
	45	FRN0085E2■-4□		150			SC-N3
	55	FRN0105E2■-4□	125	200	SC-N4	SC-N5	SC-N4
	75	FRN0139E2■-4□	175	-			SC-N7
	90	FRN0168E2■-4□	200		-	SC-N8	-
	110	FRN0203E2■-4□	250	-			
	132	FRN0240E2■-4□	300		-	SC-N11	-
	160	FRN0290E2■-4□	350	-			
	200	FRN0361E2■-4□	500		-	SC-N12	-
	220	FRN0415E2■-4□		600			
280	FRN0520E2■-4□	800	-		-	-	SC-N14
315	FRN0590E2■-4□			800			800

HD mode (kW rating motor)

Power supply voltage	Nominal applied motor (kW)	Inverter type	MCCB, RCD/ELCB rated current (A)		Magnetic contactor (MC)		
			DC reactors (DCRs)		Input circuit		Output circuit
			w/ DCR	w/o DCR	DC reactors (DCRs)	DC reactors (DCRs)	
Three-phase 400V	0.75	FRN0002E2■-4□	5	5	SC-05	SC-05	SC-05
	1.1	FRN0004E2■-4□		10			
	2.2	FRN0006E2■-4□	10	15	SC-05	SC-05	SC-05
	3.0	FRN0007E2■-4□		30			
	5.5	FRN0012E2■-4□	15	30	SC-4-0	SC-N1	SC-4-0
	7.5	FRN0022E2■-4□	20	40			SC-5-1
	11	FRN0029E2■-4□	30	50	SC-N1	SC-N2	SC-N1
	15	FRN0037E2■-4□	40	60			
	18.5	FRN0044E2■-4□	50	75	SC-N1	SC-N2S	SC-N1
	22	FRN0059E2■-4□		100			
	30	FRN0072E2■-4□	75	125	SC-N2	SC-N3	SC-N2
	37	FRN0085E2■-4□	100	150			SC-N2S
	45	FRN0105E2■-4□	125	150	SC-N3	SC-N4	SC-N3
	55	FRN0139E2■-4□		200			200
	75	FRN0168E2■-4□	175	-	SC-N7	-	SC-N5
	90	FRN0203E2■-4□	200				-
	110	FRN0240E2■-4□	250	-	SC-N8	-	
	132	FRN0290E2■-4□	300				-
	160	FRN0361E2■-4□	350	-	SC-N12	-	
	200	FRN0415E2■-4□	500				-
220	FRN0520E2■-4□	600		-	SC-N12	-	
250	FRN0590E2■-4□		600				600

Note: A box (■) in the above table replaces S (Basic type) or E (EMC filter built-in type) depending on the enclosure. A box (□) in the above table replaces GA, GB or C depending on the model.

- Install the MCCB or RCD/ELCB at the input side of the inverter. They cannot be installed at the output side of the inverter.
- The above table lists the rated current of MCCBs and RCD/ELCBs to be used in the power control panel with an internal temperature of lower than 50°C (122°F). The rated current is factored by a correction coefficient of 0.85 as the RCDs'/MCCBs' and ELCBs' original rated current is specified when using them in a surrounding temperature of 40°C (104°F) or lower. Select an MCCB and/or RCD/ELCB suitable for the actual short-circuit breaking capacity needed for your power systems.
- For the selection of the MC type, it is assumed that HIV (allowable surrounding temperature: 75°C (167°F)) wires for the power input/output of the inverter are used. If an MC type for another class of wires is selected, the wire size suitable for the terminal size of both the inverter and the MC type should be taken into account.
- Use ELCBs with overcurrent protection.
- To protect your power systems from secondary accidents caused by the broken inverter, use an MCCB and/or RCD/ELCB with the rated current listed in the above table. Do not use an MCCB or RCD/ELCB with a rating higher than that listed.

11.3 Molded Case Circuit Breaker (MCCB), Residual-current-operated Protective Device (RCD)/Earth Leakage Circuit Breaker (ELCB) and Magnetic Contactor (MC)

Table 11.3-1 Rated Current of Molded Case Circuit Breaker (MCCB), Residual-Current-Operated Protective Device (RCD)/ Earth Leakage Circuit Breaker (ELCB) and Magnetic Contactor (MC) (continued)

HND mode (kW rating motor)

Power supply voltage	Nominal applied motor (kW)	Inverter type	MCCB, RCD/ELCB rated current (A)		Magnetic contactor (MC)					
			DC reactors (DCRs)		Input circuit		Output circuit			
			w/ DCR	w/o DCR	DC reactors (DCRs)	DC reactors (DCRs)				
Three-phase 200V	0.2	FRN0001E2-2□	5	5	SC-05	SC-05	SC-05			
	0.4	FRN0002E2-2□								
	0.75	FRN0004E2-2□								
	1.1	FRN0006E2-2□	10	10	SC-05	SC-05	SC-05			
	2.2	FRN0010E2-2□								
	3.0	FRN0012E2-2□								
	5.5	FRN0020E2-2□	30	40	SC-4-0	SC-N1	SC-4-0			
	7.5	FRN0030E2-2□	40	75	SC-5-1	SC-N2	SC-N1			
	11	FRN0040E2-2□	50	100	SC-N1	SC-N2S				
	15	FRN0056E2-2□	75	125	SC-N2	SC-N3	SC-N2			
	18.5	FRN0069E2-2□	100	150	SC-N2S	SC-N4	SC-N2S	SC-N2S		
	22	FRN0088E2-2□					175	SC-N5	SC-N3	
30	FRN0115E2-2□	200					SC-N4	SC-N7	SC-N4	
Three-phase 400V	0.75	FRN0002E2-4□	5	5	SC-05	SC-05	SC-05			
	1.5	FRN0004E2-4□								
	2.2	FRN0006E2-4□								
	3.0	FRN0007E2-4□	10	15	SC-05	SC-05	SC-05			
	5.5	FRN0012E2-4□								
	7.5	FRN0022E2-4□								
	11	FRN0029E2-4□	30	50	SC-4-0	SC-N1	SC-4-0			
	15	FRN0037E2-4□	40	60	SC-5-1	SC-N1	SC-5-1			
	18.5	FRN0044E2-4□					75	SC-N1	SC-N2	SC-N1
	22	FRN0059E2-4□					100	SC-N1	SC-N2S	SC-N1
	30	FRN0072E2-4□	75	125	SC-N2	SC-N3	SC-N2			
	37	FRN0085E2-4□	100	125	SC-N2S	SC-N4	SC-N2S			
	45	FRN0105E2-4□					150	SC-N3	SC-N3	
	55	FRN0139E2-4□					200	SC-N3	SC-N5	SC-N4
	75	FRN0168E2-4□	175	-	SC-N4	-	SC-N5			
	90	FRN0203E2-4□	200	-	SC-N7	-	SC-N7			
	110	FRN0240E2-4□	250	-	SC-N8	-	SC-N8			
	132	FRN0290E2-4□	300	-	SC-N11	-	SC-N11			
160	FRN0361E2-4□	350	-	SC-N11	-	SC-N11				
200	FRN0415E2-4□	500	500	SC-N12	SC-N12	SC-N12				
220	FRN0520E2-4□					500	SC-N12	SC-N12		
280	FRN0590E2-4□					600	SC-N14	SC-N14		

Note: A box (■) in the above table replaces S (Basic type) or E (EMC filter built-in type) depending on the enclosure. A box (□) in the above table replaces GA, GB or C depending on the model.

- Install the MCCB or RCD/ELCB at the input side of the inverter. They cannot be installed at the output side of the inverter.
- The above table lists the rated current of MCCBs and RCD/ELCBs to be used in the power control panel with an internal temperature of lower than 50°C (122°F). The rated current is factored by a correction coefficient of 0.85 as the RCDs/MCCBs' and ELCBs' original rated current is specified when using them in a surrounding temperature of 40°C (104°F) or lower. Select an MCCB and/or RCD/ELCB suitable for the actual short-circuit breaking capacity needed for your power systems.
- For the selection of the MC type, it is assumed that the 600 V HIV (allowable surrounding temperature: 75°C (167°F)) wires for the power input/output of the inverter are used. If an MC type for another class of wires is selected, the wire size suitable for the terminal size of both the inverter and the MC type should be taken into account.
- Use ELCBs with overcurrent protection.
- To protect your power systems from secondary accidents caused by the broken inverter, use an MCCB and/or RCD/ELCB with the rated current listed in the above table. Do not use an MCCB or RCD/ELCB with a rating higher than that listed.

11.3 Molded Case Circuit Breaker (MCCB), Residual-current-operated Protective Device (RCD)/Earth Leakage Circuit Breaker (ELCB) and Magnetic Contactor (MC)

Table 11.3-1 Rated Current of Molded Case Circuit Breaker (MCCB), Residual-Current-Operated Protective Device (RCD)/ Earth Leakage Circuit Breaker (ELCB) and Magnetic Contactor (MC) (continued)

HHD mode (kW rating motor)

Power supply voltage	Nominal applied motor (kW)	Inverter type	MCCB, RCD/ELCB rated current (A)		Magnetic contactor (MC)		
			DC reactors (DCRs)		Input circuit		Output circuit
			w/ DCR	w/o DCR	DC reactors (DCRs)	DC reactors (DCRs)	
					w/ DCR	w/o DCR	
Three-phase 200V	0.1	FRN0001E2-2□	5	5	SC-05	SC-05	SC-05
	0.2	FRN0002E2-2□					
	0.4	FRN0004E2-2□					
	0.75	FRN0006E2-2□	10	10			
	1.5	FRN0010E2-2□					
	2.2	FRN0012E2-2□					
	3.7	FRN0020E2-2□	20	30		SC-4-0	
	5.5	FRN0030E2-2□	30	50	SC-4-0	SC-5-1	SC-4-0
	7.5	FRN0040E2-2□	40	75	SC-5-1	SC-N1	SC-N1
	11	FRN0056E2-2□	50	100	SC-N1	SC-N2S	SC-N2
	15	FRN0069E2-2□	75	125	SC-N2	SC-N3	SC-N2
	18.5	FRN0088E2-2□	100	150	SC-N2S	SC-N4	SC-N2S
22	FRN0115E2-2□	175				SC-N5	SC-N3
Three-phase 400V	0.4	FRN0002E2-4□	5	5	SC-05	SC-05	SC-05
	0.75	FRN0004E2-4□					
	1.5	FRN0006E2-4□					
	2.2	FRN0007E2-4□	10	15			
	3.7	FRN0012E2-4□					
	5.5	FRN0022E2-4□					
	7.5	FRN0029E2-4□	20	40		SC-4-0	
	11	FRN0037E2-4□	30	50	SC-4-0	SC-N1	SC-4-0
	15	FRN0044E2-4□	40	60	SC-5-1	SC-N1	SC-5-1
	18.5	FRN0059E2-4□					75
	22	FRN0072E2-4□	50	100	SC-N1	SC-N2S	SC-N1
	30	FRN0085E2-4□	75	125	SC-N2	SC-N3	SC-N2
	37	FRN0105E2-4□	100		150	SC-N2S	SC-N4
	45	FRN0139E2-4□		125		200	SC-N3
	55	FRN0168E2-4□	175	-	SC-N4	-	SC-N4
	75	FRN0203E2-4□	200		SC-N7		SC-N5
	90	FRN0240E2-4□	250		SC-N8		SC-N7
	110	FRN0290E2-4□	300		SC-N11		SC-N8
	132	FRN0361E2-4□	350		SC-N12		SC-N11
	160	FRN0415E2-4□	500				SC-N12
200	FRN0520E2-4□						
220	FRN0590E2-4□						
Single-phase 200V	0.1	FRN0001E2-7□	5	5	SC-05	SC-05	SC-05
	0.2	FRN0002E2-7□					
	0.4	FRN0003E2-7□					
	0.75	FRN0005E2-7□	10	15			
	1.5	FRN0008E2-7□					
	2.2	FRN0011E2-7□					

Note: A box (■) in the above table replaces S (Basic type) or E (EMC filter built-in type) depending on the enclosure. A box (□) in the above table replaces GA, GB or C depending on the model.

- Install the MCCB or RCD/ELCB at the input side of the inverter. They cannot be installed at the output side of the inverter.
- The above table lists the rated current of MCCBs and RCD/ELCBs to be used in the power control panel with an internal temperature of lower than 50°C (122°F). The rated current is factored by a correction coefficient of 0.85 as the RCDs'/MCCBs' and ELCBs' original rated current is specified when using them in a surrounding temperature of 40°C (104°F) or lower. Select an MCCB and/or RCD/ELCB suitable for the actual short-circuit breaking capacity needed for your power systems.
- For the selection of the MC type, it is assumed that the 600 V HIV (allowable surrounding temperature: 75°C (167°F)) wires for the power input/output of the inverter are used. If an MC type for another class of wires is selected, the wire size suitable for the terminal size of both the inverter and the MC type should be taken into account.
- Use ELCBs with overcurrent protection.
- To protect your power systems from secondary accidents caused by the broken inverter, use an MCCB and/or RCD/ELCB with the rated current listed in the above table. Do not use an MCCB or RCD/ELCB with a rating higher than that listed.

11.3 Molded Case Circuit Breaker (MCCB), Residual-current-operated Protective Device (RCD)/Earth Leakage Circuit Breaker (ELCB) and Magnetic Contactor (MC)

Table 11.3-1 Rated Current of Molded Case Circuit Breaker (MCCB), Residual-Current-Operated Protective Device (RCD)/ Earth Leakage Circuit Breaker (ELCB) and Magnetic Contactor (MC) (continued)

ND, HD, HND, HHD mode (HP rating motor)

Voltage class	Nominal applied motor (HP)	Inverter type ND mode	Inverter type HD mode	Inverter type HND mode	Inverter type HHD mode	MCCB, RCD/ELCB rated current (A)		Magnetic contactor (MC)		
						w/ DCR	w/o DCR	Input circuit		Output circuit
								DC reactors (DCRs) w/ DCR	DC reactors (DCRs) w/o DCR	
Three-phase 230V class	1/8	-	-	-	FRN0001E2-2□	5	5	SC-05	SC-05	SC-05
	1/4	-	-	FRN0001E2-2□	FRN0002E2-2□					
	1/2	-	-	FRN0002E2-2□	FRN0004E2-2□					
	1	-	-	FRN0004E2-2□	FRN0006E2-2□					
	1.5	-	-	FRN0006E2-2□	-					
	2	-	-	-	FRN0010E2-2□					
	3	-	-	FRN0010E2-2□	FRN0012E2-2□					
	4	-	-	FRN0012E2-2□	-					
	5	-	-	-	FRN0020E2-2□					
	7.5	-	-	FRN0020E2-2□	-					
	10	-	-	-	FRN0030E2-2□					
	15	-	-	FRN0030E2-2□	FRN0040E2-2□					
	20	-	-	FRN0040E2-2□	FRN0056E2-2□					
	25	-	-	FRN0056E2-2□	FRN0069E2-2□					
	30	-	-	FRN0069E2-2□	FRN0088E2-2□					
	40	-	-	FRN0088E2-2□	FRN0115E2-2□					
Three-phase 460V class	1/2	-	-	-	FRN0002E2-4□	5	5	SC-05	SC-05	SC-05
	1	FRN0002E2-4□	FRN0002E2-4□	FRN0002E2-4□	FRN0004E2-4□					
	1.5	-	FRN0004E2-4□	FRN0004E2-4□	-					
	2	FRN0004E2-4□	-	-	FRN0006E2-4□					
	3	FRN0006E2-4□	FRN0006E2-4□	FRN0006E2-4□	FRN0007E2-4□					
	4	FRN0007E2-4□	FRN0007E2-4□	FRN0007E2-4□	-					
	5	-	-	-	FRN0012E2-4□					
	7.5	FRN0012E2-4□	FRN0012E2-4□	FRN0012E2-4□	FRN0022E2-4□					
	10	-	FRN0022E2-4□	FRN0022E2-4□	FRN0029E2-4□					
	15	FRN0022E2-4□	FRN0029E2-4□	FRN0029E2-4□	FRN0037E2-4□					
	20	FRN0029E2-4□	FRN0037E2-4□	FRN0037E2-4□	FRN0044E2-4□					
	25	FRN0037E2-4□	FRN0044E2-4□	FRN0044E2-4□	FRN0059E2-4□					
	30	FRN0044E2-4□	FRN0059E2-4□	FRN0059E2-4□	FRN0072E2-4□					
	40	FRN0059E2-4□	FRN0072E2-4□	FRN0072E2-4□	FRN0085E2-4□					
	50	FRN0072E2-4□	FRN0085E2-4□	FRN0085E2-4□	FRN0105E2-4□					
	60	FRN0085E2-4□	FRN0105E2-4□	FRN0105E2-4□	FRN0139E2-4□					
	75	FRN0105E2-4□	FRN0139E2-4□	FRN0139E2-4□	FRN0168E2-4□					
	100	FRN0139E2-4□	FRN0168E2-4□	FRN0168E2-4□	FRN0203E2-4□					
	125	FRN0168E2-4□	FRN0203E2-4□	FRN0203E2-4□	FRN0240E2-4□					
	150	FRN0203E2-4□	FRN0240E2-4□	FRN0240E2-4□	FRN0290E2-4□					
200	FRN0240E2-4□	FRN0290E2-4□	FRN0290E2-4□	FRN0361E2-4□						
250	-	FRN0361E2-4□	FRN0361E2-4□	FRN0415E2-4□						
300	FRN0361E2-4□	FRN0415E2-4□	FRN0415E2-4□	FRN0520E2-4□						
350	FRN0415E2-4□	FRN0520E2-4□	FRN0520E2-4□	FRN0590E2-4□						
400	-	FRN0590E2-4□	-	-						
450	FRN0520E2-4□	-	FRN0590E2-4□	-						
500	FRN0590E2-4□	-	-	-						
Single-phase 230V class	1/8	-	-	-	FRN0001E2-7□	5	5	SC-05	SC-05	SC-05
	1/4	-	-	-	FRN0002E2-7□					
	1/2	-	-	-	FRN0003E2-7□					
	1	-	-	-	FRN0005E2-7□					
	2	-	-	-	FRN0008E2-7□					
	3	-	-	-	FRN0011E2-7□					

Note: A box (■) in the above table replaces S (Basic type) or E (EMC filter built-in type) depending on the enclosure. A box (□) in the above table replaces GA, GB or C depending on the model.

- Install the MCCB or RCD/ELCB at the input side of the inverter. They cannot be installed at the output side of the inverter.
- The above table lists the rated current of MCCBs and RCD/ELCBs to be used in the power control panel with an internal temperature of lower than 50°C (122°F). The rated current is factored by a correction coefficient of 0.85 as the RCDs/MCCBs' and ELCBs' original rated current is specified when using them in a surrounding temperature of 40°C (104°F) or lower. Select an MCCB and/or RCD/ELCB suitable for the actual short-circuit breaking capacity needed for your power systems.
- For the selection of the MC type, it is assumed that the 600 V HIV (allowable surrounding temperature: 75°C (167°F)) wires for the power input/output of the inverter are used. If an MC type for another class of wires is selected, the wire size suitable for the terminal size of both the inverter and the MC type should be taken into account.
- Use ELCBs with overcurrent protection.
- To protect your power systems from secondary accidents caused by the broken inverter, use an MCCB and/or RCD/ELCB with the rated current listed in the above table. Do not use an MCCB or RCD/ELCB with a rating higher than that listed.

11.3 Molded Case Circuit Breaker (MCCB), Residual-current-operated Protective Device (RCD)/Earth Leakage Circuit Breaker (ELCB) and Magnetic Contactor (MC)

Table 11.3-2 lists the relationship between the rated leakage current sensitivity of RCDs/ELCBs (with overcurrent protection) and wiring length of the inverter output circuits. Note that the sensitivity levels listed in the table are estimated values based on the results obtained by the test setup in the Fuji laboratory where each inverter drives a single motor.

Table 11.3-2 Rated Current Sensitivity of Residual-Current-Operated Protective Device (RCD)/ Earth Leakage Circuit Breakers (ELCBs)

Voltage class	Nominal applied motor (kW) [HP]	Wiring length and current sensitivity					
		10m (33ft)	30m (98ft)	50m (164ft)	100m (328ft)	200m (656ft)	300m (984ft)
Three-phase 200V class	0.1 [1/8]						
	0.2 [1/4]						
	0.4 [1/2]						
	0.75 [1]						
	1.5 [2]						
	2.2 [3]		30mA				
	3.7 [5]						
	5.5 [7.5]						
	7.5 [10]					100mA	
	11 [15]						
	15 [20]						
	18.5 [25]						200mA
	22 [30]						
	30 [40]						
	37 [50]						
	45 [60]						
	55 [75]						
75 [100]						500mA	
90 [125]							
110 [150]							
Three-phase 400V class	0.4 [1/2]						
	0.75 [1]						
	1.5 [2]						
	2.2 [3]						
	3.7 [5]	30mA					
	5.5 [7.5]						
	7.5 [10]						
	11 [15]						
	15 [20]						
	18.5 [25]						
	22 [30]						
	30 [40]		100mA				
	37 [50]					200mA	
	45 [60]						
	55 [75]						500mA
	75 [100]						
	90 [125]						1000mA
	110 [150]						
	132 [200]						
	160 [250]						
	200 [300]						
	220 [350]						
	250 [400]						
280 [450]							
315 [475]						3000mA	
355 [500]							
400 [600]							
450 [700]							
500 [800]							
630 [900]							

- Values listed above were obtained using Fuji ELCB EG or SG series applied to the test setup.
- The rated current of applicable motor rating indicates values for Fuji standard motor (4 poles, 50 Hz and 200 V three-phase).
- The leakage current is calculated based on neutral grounding for 400 V class Y-connection power lines.
- Values listed above are calculated based on the static capacitance to the earth when the 600 V class of vinyl-insulated IV wires are used in a wiring through metal conduit pipes.
- Wiring length is the total length of wiring between the inverter and motor. If more than one motor is to be connected to a single inverter, the wiring length should be the total length of wiring between the inverter and motors.

11.4 Surge Killers for L-load

A surge killer absorbs surge voltage induced by L-load of an electro magnetic switch or solenoid valve. Use of a surge killer is effective in preventing the electronic equipment, including inverters, from damage or malfunctioning caused by such surges.

Install a surge killer near the power coil of the surge source. Connected to the inverter’s power source side, as shown in Figure 11.4-1, a surge killer absorbs the surge voltage, preventing the electronic equipment, from damage or malfunctioning. (Available rated capacity of nominal applied motors is 3.7 kW (5 HP) or less.)

Refer to the catalog “Fuji Surge Killers/Absorbers (HS118: Japanese edition only)” for details. These products are available from Fuji Electric Technica Co., Ltd.

* Do not use the surge killer in the inverter secondary (output) line.

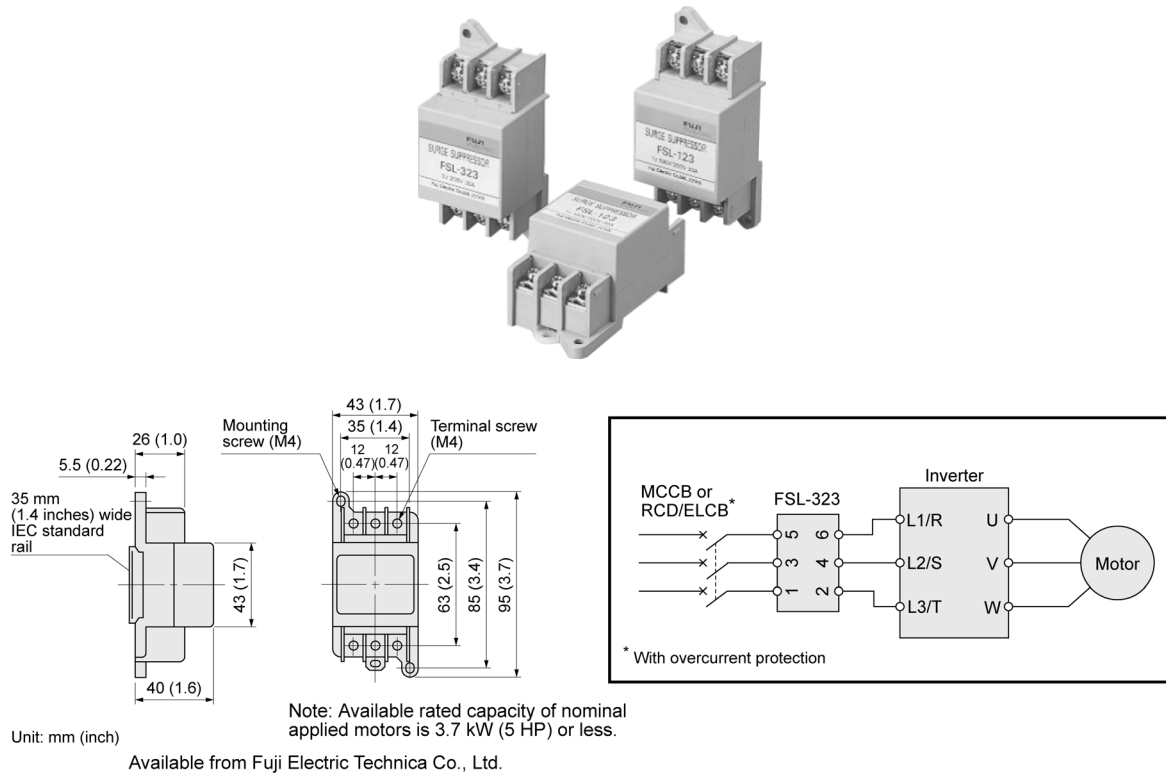

Figure 11.4-1 Dimensions of Surge Killer and Connection Example

11.5 Arresters

An arrester suppresses surge currents induced by lightning invaded from the power supply lines. Use of the grounding wire that is used commonly for electric equipment in the panel, combined with the arrester, is effective in preventing electronic equipment from damage or malfunctioning caused by such surges.

Applicable arrester models are CN5132 for three-phase 200V class series, and CN5134 for three-phase 400V class series. (CN523 series with 20 kA of discharging capability is also available.) Figure 11.5-1 shows their external dimensions and connection examples. Refer to the catalog “Fuji Surge Killers/Absorbers (HS165a: Japanese edition only)” for details. These products are available from Fuji Electric Technica Co., Ltd.



● Tree-phase (AC240/440V)

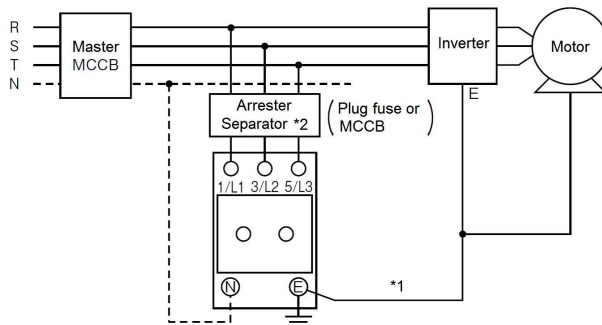

- *1: Keep the wiring length as short as possible.
- *2: The models with a built-in arrester separator (CN5212-FK and CN5232-FK) are not required when the short-circuit current of the circuit is 250 VAC, 10kA or less.

(N-phase terminal is only for CN5234 and CN5234-K.)

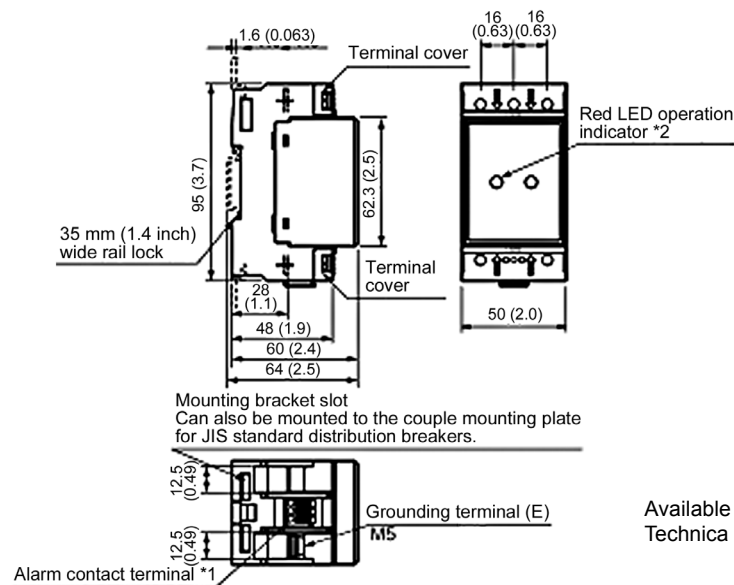

Available from Fuji Electric Technica Co., Ltd.

Unit: mm (inch)

- *1 Available only on the CN5□-K series.
- *2 Two-pole models have only the left indicator.

Figure 11.5-1 Arrester Dimensions and Connection Examples

11.6 Surge Absorbers

A surge absorber absorbs surges or noises generated by a magnetic contactor (MC) or solenoid valve in the power system to effectively protect electronic equipment in the panel from malfunctions or breakdown. Installed parallel to a coil of an MC, solenoid valve, or L load, a surge absorber absorbs the surge voltage.

Applicable surge absorber models are the S2-A-O and S1-B-O. Figure 11.6-1 shows their external dimensions.

These products are available from Fuji Electric Technica Co., Ltd.

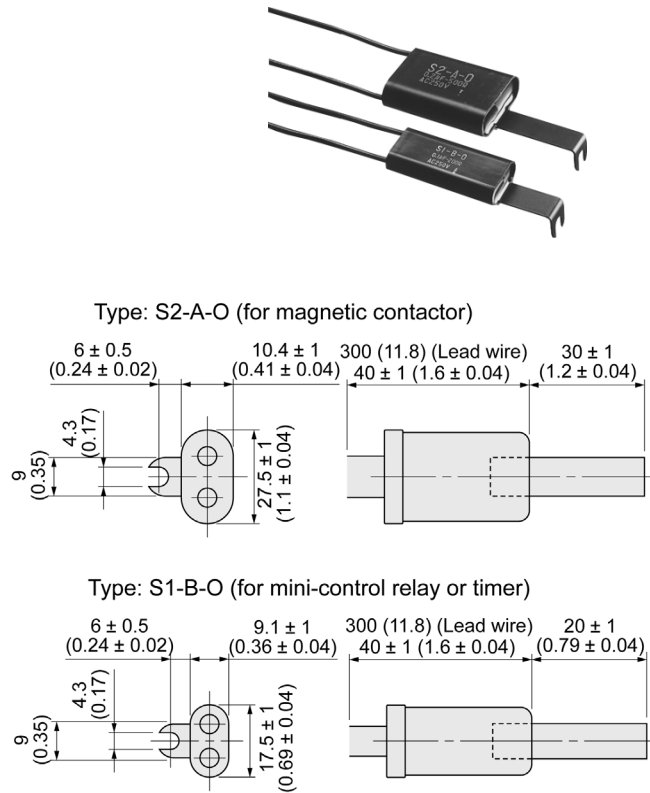

Unit: mm (inch)

Available from Fuji Electric Technica Co., Ltd.

Figure 11.6-1 Surge Absorber Dimensions

11.7 Filtering Capacitors Suppressing AM Radio Band Noises

These capacitors are effective to suppress AM radio band (less than 1 MHz) noises. Using them with Zero-phase reactors upgrades capability.

Applicable models are NFM25M315KPD1 for 200 V class series inverters and NFM60M315KPD for 400 V class. Use one of them regardless of the inverter capacity. Figure 11.7-1 shows their external dimensions. These products are available from Fuji Electric Technica Co., Ltd.

* Do not use the filtering capacitor in the inverter secondary (output) line.

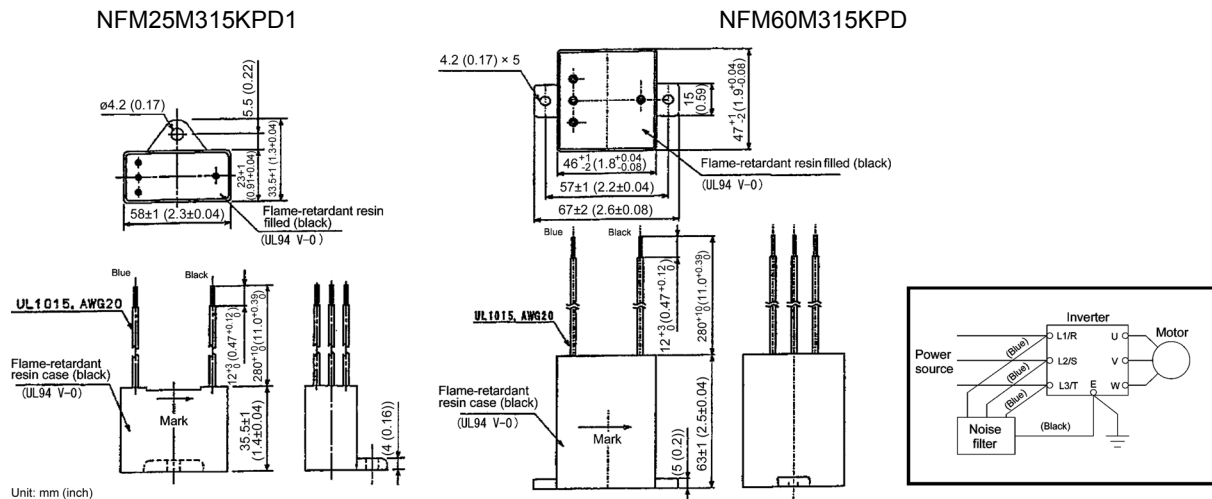

Figure 11.7-1 Filtering Capacitors Dimensions

11.8 Braking Resistors (DBRs) and Braking Units

11.8.1 Selecting a braking resistor

[1] Selection procedure

Depending on the cyclic period, the following requirements must be satisfied.

- (1) If the cyclic period is 100 s or less: [Requirement 1] and [Requirement 3]
- (2) If the cyclic period exceeds 100 s: [Requirement 1] and [Requirement 2]

[Requirement 1] : The maximum braking torque should not exceed the values listed in the tables in “11.8.4 Specifications”. To use the maximum braking torque exceeding the values in those tables, select the braking resistor whose capacity is one class larger.

[Requirement 2] : The discharge energy for a single braking action should not exceed the discharging capability (kW) listed in the tables. For calculation details, refer to Chapter 10 “10.3.3 Heat energy calculation of braking resistor.”

[Requirement 3] : The average loss that is calculated by dividing the discharge energy by the cyclic period must not exceed the average allowable loss (kW) listed in the tables in “11.8.4 Specifications”.

[2] Notes on selection

The braking time T_1 , cyclic period T_0 , and duty cycle %ED are converted under deceleration braking conditions based on the rated torque as shown in Figure 11.8-1. However, it is not necessary to consider these values in the selection of braking resistor capacity.

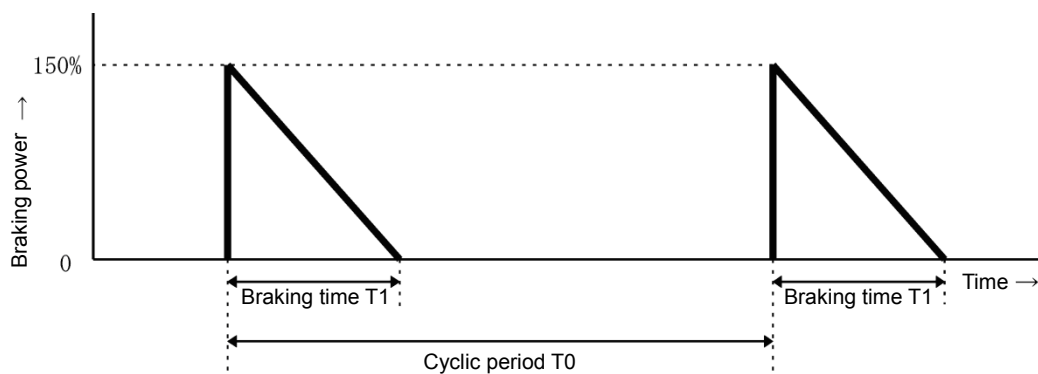

Figure 11.8-1 Duty Cycle

$$\text{Duty cycle (\%ED)} = \frac{T_1}{T_0} \times 100 (\%)$$

11.8.2 Braking resistors (DBRs)

A braking resistor converts regenerative energy generated from the deceleration of the motor to heat. Use of a braking resistor results in improved deceleration performance of the inverter.

[1] Standard model

The standard model of a braking resistor integrates a facility that detects the temperature on the heat sink of the resistor and outputs a digital ON/OFF signal if the temperature exceeds the specified level (as an overheating warning signal). To ensure that the signal is recognized at one of the digital input terminals of the FRENIC-Ace, assign the external alarm THR to any of terminals [X1] to [X5], [FWD] and [REV]. Connect the assigned terminals to terminals [1] and [2] of the braking resistor. Upon detection of the warning signal (preset detection level: 150°C), the inverter simultaneously transfers to Alarm mode, displays alarm $\square H \square$ on the LED monitor and shuts down its power output.

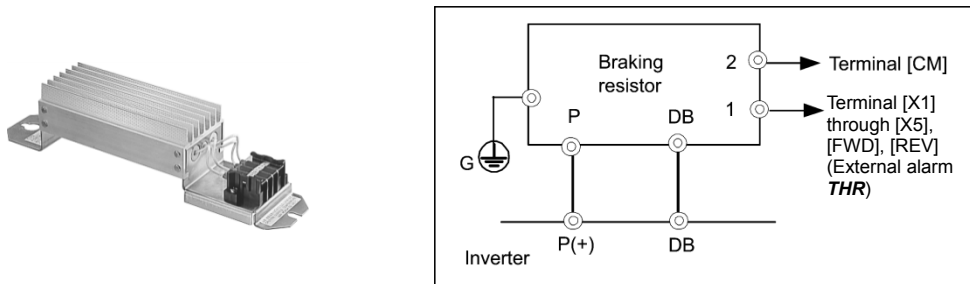

Figure 11.8-2 Braking Resistor (Standard Model) and Connection Example

[2] 10%ED model

The 10%ED braking resistors do not support overheating detection or warning output, so an electronic thermal overload relay needs to be set up using function codes F50 and F51 to protect the braking resistor from overheating.

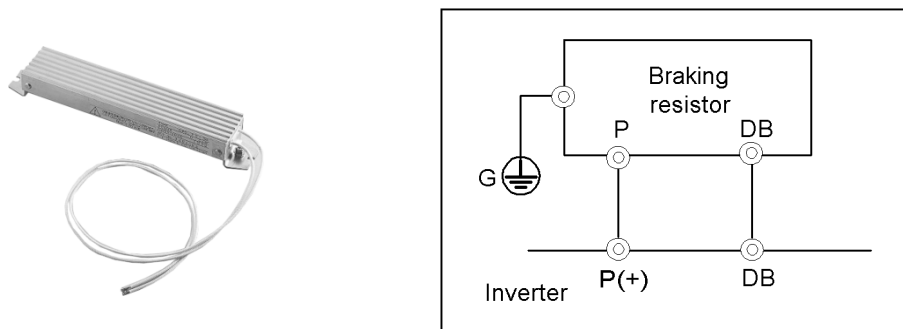



Figure 11.8-3 Braking Resistor (10%ED Model) and Connection Example

 For the specifications and external dimensions of the braking units, refer to “11.8.4 Specifications” and 11.8.5 External dimensions”.

11.8.3 Braking units

Add a braking unit to the braking resistor to upgrade the braking capability of inverters with the following models.

FRN0085E2-4□ to FRN0590E2-4□.

FRN0072E2-4□/FRN0115E2-2□/FRN0011E2-7□ or the lower models of inverters have built-in IGBTs for the braking resistor.



Figure 11.8-4 Braking Unit

 For the specifications and external dimensions of the braking units, refer to “11.8.4 Specifications” and 11.8.5 External dimensions”.

11.8.4 Specifications

Table 11.8-1 Generated Loss in Braking Unit

Model	Generated loss (W)	Min. connection resistance (Ω)
BU37-4C	35	12
BU55-4C	40	7.5
BU90-4C	50	4.7
BU132-4C	60	3.0
BU220-4C	80	1.9

* 10%ED

Table 11.8-2 Braking Unit and Braking Resistor (Standard Model)

ND mode (kW rating motor)

Power supply voltage	Nominal applied motor (kW)	Inverter type	Selecting Options					Maximum braking torque		Continuous braking (100% braking torque)		Repetitive braking (each cycle is 100 s or less)				
			Braking units		Braking resistor			50Hz	60Hz	Discharging capability	Braking time	Average allowable loss	Duty cycle			
			Model	Q'ty	Model	Q'ty	Resistance (Ω)	(N·m)	(N·m)	(kW)	(s)	(kW)	(%ED)			
Three-phase 400V	0.75	FRN0002E2■-4□	-				75	3.79	3.13	9	24	0.044	12			
	1.5	FRN0004E2■-4□						DB0.75-4	1	200	7.50	6.20	17	22	0.068	9
	2.2	FRN0006E2■-4□						DB2.2-4	1	160	11.0	9.10	34	30	0.075	6
	3.0	FRN0007E2■-4□									15.0	12.4	33	22	0.077	5
	5.5	FRN0012E2■-4□						DB3.7-4	1	130	27.2	22.5	37	13	0.093	3
	11	FRN0022E2■-4□									54.0	44.8	55	10	0.138	2.5
	15	FRN0029E2■-4□						DB7.5-4	1	60	73.5	61.0	38	5	0.188	2.5
	18.5	FRN0037E2■-4□									91.0	75.5	55	5	0.275	3
	22	FRN0044E2■-4□						DB15-4	1	34.4	108	89.5	75	6	0.375	3
	30	FRN0059E2■-4□									146	121	93	6	0.463	3
	37	FRN0072E2■-4□	DB22-4	1	22	180	150	88	4.7	0.55	3					
	45	FRN0085E2■-4□				220	182	185	10	1.85	10					
	55	FRN0105E2■-4□	BU37-4C	1	DB37-4C	1	12	268	223	225	10	2.25	10			
	75	FRN0139E2■-4□						BU55-4C	1	DB45-4C	1	10	365	303	275	10
	90	FRN0168E2■-4□	BU90-4C	1	DB75-4C	1	6.5						437	364	375	10
	110	FRN0203E2■-4□						DB110-4C	1	4.7	534	444	450	10	4.50	10
	132	FRN0240E2■-4□	BU132-4C	1	DB132-4C	1	3.9				641	533	550	10	5.50	10
	160	FRN0290E2■-4□						BU220-4C	1	DB160-4C	1	3.2	777	646	660	10
	200	FRN0361E2■-4□	DB200-4C	1	2.6	971	807						800	10	8.00	10
	220	FRN0415E2■-4□				DB220-4C	1	2.2	1068	888	1000	10	10.0	10		
280	FRN0520E2■-4□	DB160-4C	2	1.6	1360				1130	1100	10	11.0	10			
315	FRN0590E2■-4□				1529	1271	1181	10	11.9	10						

Note: A box (■) in the above table replaces S (Basic type) or E (EMC filter built-in type) depending on the enclosure.
 A box (□) in the above table replaces GA, GB or C depending on the model.

11.8 Braking Resistors (DBRs) and Braking Units

Table 11.8-3 Braking Unit and Braking Resistor (Standard Model)

HD mode (kW rating motor)

Power supply voltage	Nominal applied motor (kW)	Inverter type	Selecting Options					Maximum braking torque		Continuous braking (100% braking torque)		Repetitive braking (each cycle is 100 s or less)		
			Braking units		Braking resistor			50Hz	60Hz	Discharging capability	Braking time	Average allowable loss	Duty cycle	
			Model	Q'ty	Model	Q'ty	Resistance (Ω)	(N·m)	(N·m)	(kW)	(s)	(kW)	(%ED)	
Three-phase 400V	0.75	FRN0002E2■-4□	-					100	5.05	4.17	9	24	0.044	12
	1.1	FRN0004E2■-4□							7.33	6.06	17	30	0.068	12
	2.2	FRN0006E2■-4□							14.7	12.1	34	30	0.075	7
	3.0	FRN0007E2■-4□							20.1	16.5	33	22	0.077	5
	5.5	FRN0012E2■-4□							36.2	30.0	37	13	0.093	3.5
	7.5	FRN0022E2■-4□							49.6	41.0	55	15	0.138	3.5
	11	FRN0029E2■-4□							72.0	59.7	38	7	0.188	3.5
	15	FRN0037E2■-4□							98.1	81.4	55	7	0.275	3.5
	18.5	FRN0044E2■-4□							121	100	75	8	0.375	4
	22	FRN0059E2■-4□							144	119	93	8	0.463	4
	30	FRN0072E2■-4□	195	162	88	6	0.55	3.5						
	37	FRN0085E2■-4□	BU37-4C	1	DB37-4C	1	12	240	200	185	10	1.85	10	
	45	FRN0105E2■-4□	BU55-4C	1	DB45-4C	1	10	293	243	225	10	2.25	10	
	55	FRN0139E2■-4□			DB55-4C	1	7.5	357	298	275	10	2.75	10	
	75	FRN0168E2■-4□	BU90-4C	1	DB75-4C	1	6.5	487	405	375	10	3.75	10	
	90	FRN0203E2■-4□			DB110-4C	1	4.7	583	486	450	10	4.50	10	
	110	FRN0240E2■-4□	BU132-4C	1	DB132-4C	1	3.9	712	592	550	10	5.50	10	
	132	FRN0290E2■-4□			DB160-4C	1	3.2	855	710	660	10	6.60	10	
	160	FRN0361E2■-4□	BU220-4C	1	DB200-4C	1	2.6	1036	861	800	10	8.00	10	
	200	FRN0415E2■-4□			DB220-4C	1	2.2	1295	1076	1000	10	10.0	10	
220	FRN0520E2■-4□	1424			1184	1100	10	11.0	10					
250	FRN0590E2■-4□	1623			1352	1250	10	12.5	10					

Note: A box (■) in the above table replaces S (Basic type) or E (EMC filter built-in type) depending on the enclosure.
A box (□) in the above table replaces GA, GB or C depending on the model.

11.8 Braking Resistors (DBRs) and Braking Units

Table 11.8-4 Braking Unit and Braking Resistor (Standard Model)

HND mode (kW rating motor)

Power supply voltage	Nominal applied motor (kW)	Inverter type	Selecting Options					Maximum braking torque		Continuous braking (100% braking torque)		Repetitive braking (each cycle is 100 s or less)		
			Braking units		Braking resistor			50Hz	60Hz	Discharging capability	Braking time	Average allowable loss	Duty cycle	
			Model	Q'ty	Model	Q'ty	Resistance (Ω)	(N·m)	(N·m)	(kW/s)	(s)	(kW)	(%ED)	
Three-phase 200V	0.2	FRN0001E2■-2□	-		DB0.75-2	1	100	100	1.34	1.11	9	90	0.037	37
	0.4	FRN0002E2■-2□							2.68	2.21	9	45	0.037	18
	0.75	FRN0004E2■-2□							5.05	4.17	9	24	0.044	12
	1.1	FRN0006E2■-2□							7.33	6.06	17	30	0.068	12
	2.2	FRN0010E2■-2□							14.7	12.1	34	30	0.075	7
	3.0	FRN0012E2■-2□							20.1	16.5	33	22	0.077	5
	5.5	FRN0020E2■-2□							36.2	30.0	37	13	0.093	3.5
	7.5	FRN0030E2■-2□							49.1	41.0	55	15	0.138	3.5
	11	FRN0040E2■-2□							72.0	59.7	37	7	0.188	3.5
	15	FRN0056E2■-2□							98.1	81.4	55	7	0.275	3.5
	18.5	FRN0069E2■-2□							121	100	75	8	0.375	4
	22	FRN0088E2■-2□							144	119	92	8	0.463	4
30	FRN0115E2■-2□	216	179	88	6	0.55	3.5							
Three-phase 400V	0.75	FRN0002E2■-4□	-		DB0.75-4	1	200	100	5.05	4.17	9	24	0.044	12
	1.1	FRN0004E2■-4□							7.33	6.06	17	30	0.068	12
	2.2	FRN0006E2■-4□							14.7	12.1	34	30	0.075	7
	3.0	FRN0007E2■-4□							20.1	16.5	33	22	0.077	5
	5.5	FRN0012E2■-4□							36.2	30.0	37	13	0.093	3.5
	7.5	FRN0022E2■-4□							49.6	41.0	55	15	0.138	3.5
	11	FRN0029E2■-4□							72.0	59.7	38	7	0.188	3.5
	15	FRN0037E2■-4□							98.1	81.4	55	7	0.275	3.5
	18.5	FRN0044E2■-4□							121	100	75	8	0.375	4
	22	FRN0059E2■-4□							144	119	93	8	0.463	4
	30	FRN0072E2■-4□							195	162	88	6	0.55	3.5
	37	FRN0085E2■-4□							180	150	150	10	1.50	10
	45	FRN0105E2■-4□							219	182	185	10	1.85	10
	55	FRN0139E2■-4□							269	223	225	10	2.25	10
	75	FRN0168E2■-4□							365	303	275	10	2.75	10
	90	FRN0203E2■-4□							439	364	375	10	3.75	10
	110	FRN0240E2■-4□							534	444	450	10	4.50	10
	132	FRN0290E2■-4□							641	533	550	10	5.50	10
160	FRN0361E2■-4□	777	646	660	10	6.60	10							
200	FRN0415E2■-4□	971	807	800	10	8.00	10							
220	FRN0520E2■-4□	1068	888	1000	10	10.0	10							
280	FRN0590E2■-4□	1360	1130	1100	10	11.0	10							
Single-phase 200V	0.2	FRN0001E2■-7□	-		DB0.75-2	1	100	100	1.34	1.11	9	90	0.037	37
	0.4	FRN0002E2■-7□							2.68	2.21	9	45	0.037	18
	0.75	FRN0003E2■-7□							5.05	4.17	9	24	0.044	12
	1.1	FRN0005E2■-7□							7.33	6.06	17	30	0.068	12
	2.2	FRN0008E2■-7□							14.7	12.1	34	30	0.075	7
	3.0	FRN0011E2■-7□							20.1	16.5	33	22	0.077	5

Note: A box (■) in the above table replaces S (Basic type) or E (EMC filter built-in type) depending on the enclosure.
 A box (□) in the above table replaces GA, GB or C depending on the model.

11.8 Braking Resistors (DBRs) and Braking Units

Table 11.8-5 Braking Unit and Braking Resistor (Standard Model)

HHD mode (kW rating motor)

Power supply voltage	Nominal applied motor (kW)	Inverter type	Selecting Options					Maximum braking torque		Continuous braking (100% braking torque)		Repetitive braking (each cycle is 100 s or less)		
			Braking units		Braking resistor			50Hz	60Hz	Discharging capability	Braking time	Average allowable loss	Duty cycle	
			Model	Q'ty	Model	Q'ty	Resistance (Ω)	(N·m)	(N·m)	(kWs)	(s)	(kW)	(%ED)	
Three-phase 200V	0.1	FRN0001E2■-2□	-		DB0.75-2	1	100	150	1.01	0.83	9	90	0.037	37
	0.2	FRN0002E2■-2□							2.01	1.66	9	90	0.037	37
	0.4	FRN0004E2■-2□							4.02	3.32	9	45	0.044	22
	0.75	FRN0006E2■-2□							7.57	6.25	17	45	0.068	18
	1.5	FRN0010E2■-2□							15.0	12.4	34	45	0.075	10
	2.2	FRN0012E2■-2□							22.0	18.2	33	30	0.077	7
	3.7	FRN0020E2■-2□							37.1	30.5	37	20	0.093	5
	5.5	FRN0030E2■-2□							54.3	45.0	55	20	0.138	5
	7.5	FRN0040E2■-2□							73.6	61.6	38	10	0.188	5
	11	FRN0056E2■-2□							108	89.5	55	10	0.275	5
	15	FRN0069E2■-2□							147	122	75	10	0.375	5
	18.5	FRN0088E2■-2□							182	151	92	10	0.463	5
22	FRN0115E2■-2□	216	179	88	8	0.55	5							
Three-phase 400V	0.4	FRN0002E2■-4□	-		DB0.75-4	1	200	150	4.02	3.32	9	45	0.044	22
	0.75	FRN0004E2■-4□							7.57	6.25	17	45	0.068	18
	1.5	FRN0006E2■-4□							15.0	12.4	34	45	0.075	10
	2.2	FRN0007E2■-4□							22.0	18.2	33	30	0.077	7
	3.7	FRN0012E2■-4□							37.1	30.5	37	20	0.093	5
	5.5	FRN0022E2■-4□							54.3	45.0	55	20	0.138	5
	7.5	FRN0029E2■-4□							73.6	61.6	38	10	0.188	5
	11	FRN0037E2■-4□							108	89.5	55	10	0.275	5
	15	FRN0044E2■-4□							147	122	75	10	0.375	5
	18.5	FRN0059E2■-4□							182	151	93	10	0.463	5
	22	FRN0072E2■-4□							216	179	88	8	0.55	5
	30	FRN0085E2■-4□							292	243	225	10	2.25	10
	37	FRN0105E2■-4□							359	298	275	10	2.75	10
	45	FRN0139E2■-4□							487	405	375	10	3.75	10
	55	FRN0168E2■-4□							585	486	450	10	4.50	10
	75	FRN0203E2■-4□							712	592	550	10	5.50	10
	90	FRN0240E2■-4□							855	710	660	10	6.60	10
	110	FRN0290E2■-4□							1036	861	800	10	8.00	10
132	FRN0361E2■-4□	1295	1076	1000	10	10.0	10							
160	FRN0415E2■-4□	1424	1184	1100	10	11.0	10							
200	FRN0520E2■-4□													
220	FRN0590E2■-4□													
Single-phase 200V	0.1	FRN0001E2■-7□	-		DB0.75-2	1	100	150	1.01	0.83	9	90	0.037	37
	0.2	FRN0002E2■-7□							2.01	1.66	9	90	0.037	37
	0.4	FRN0003E2■-7□							4.02	3.32	9	45	0.044	22
	0.75	FRN0005E2■-7□							7.57	6.25	17	45	0.068	18
	1.5	FRN0008E2■-7□							15.0	12.4	34	45	0.075	10
	2.2	FRN0011E2■-7□							22.0	18.2	33	30	0.077	7

Note: A box (■) in the above table replaces S (Basic type) or E (EMC filter built-in type) depending on the enclosure.
A box (□) in the above table replaces GA, GB or C depending on the model.

11.8 Braking Resistors (DBRs) and Braking Units

Table 11.8-6 Braking Unit and Braking Resistor (Standard Model)

ND mode (HP rating motor)

Power supply voltage	Nominal applied motor (HP)	Inverter type	Selecting Options					Maximum braking torque		Continuous braking (100% braking torque)		Repetitive braking (each cycle is 100 s or less)																							
			Braking units		Braking resistor			50Hz	60Hz	Discharging capability	Braking time	Average allowable loss	Duty cycle																						
			Model	Q'ty	Model	Q'ty	Resistance (Ω)	(N·m)	(N·m)	(kW/s)	(s)	(kW)	(%ED)																						
Three-phase 460V	1	FRN0002E2■-4□			DB0.75-4	1	200	3.79	3.13	9	24	0.044	12																						
	2	FRN0004E2■-4□																																	
	3	FRN0006E2■-4□														DB2.2-4	1	160	11.0	9.10	34	30	0.075	6											
	4	FRN0007E2■-4□																																	
	7.5	FRN0012E2■-4□																									DB3.7-4	1	130	27.2	22.5	37	13	0.093	3
	15	FRN0022E2■-4□																									DB5.5-4	1	80	54.0	44.8	55	10	0.138	2.5
	20	FRN0029E2■-4□																																	
	25	FRN0037E2■-4□																									DB7.5-4	1	60	73.5	61.0	38	5	0.188	2.5
	30	FRN0044E2■-4□																																	
	40	FRN0059E2■-4□																									DB11-4	1	40	91.0	75.5	55	5	0.275	3
	50	FRN0072E2■-4□																																	
	60	FRN0085E2■-4□												DB15-4	1	34.4	108	89.5	75	6	0.375	3													
	75	FRN0105E2■-4□	BU37-4C	1	DB18.5-4	1	27	146	121	93	6	0.463	3																						
	100	FRN0139E2■-4□																																	
	125	FRN0168E2■-4□												DB30-4C	1	15	180	150	150	10	1.50	10													
	150	FRN0203E2■-4□																																	
	200	FRN0240E2■-4□												DB37-4C	1	12	219	182	185	10	1.85	10													
	250	-	BU55-4C	1	DB45-4C	1	10	269	223	225	10	2.25	10																						
	300	FRN0361E2■-4□																																	
	350	FRN0415E2■-4□												DB55-4C	1	7.5	365	303	275	10	2.75	10													
400	-																																		
450	FRN0520E2■-4□												DB75-4C	1	6.5	439	364	375	10	3.75	10														
500	FRN0590E2■-4□	BU90-4C	1	DB110-4C	1	4.7	534	444	450	10	4.50	10																							
													BU132-4C	1	-	-	-	-	-	-	-	-													
													BU220-4C	1	DB160-4C	1	3.2	971	807	800	10	8.00	10												
													DB200-4C	1	2.6	1068	888	1000	10	10.0	10														
													DB220-4C	1	2.2	1360	1130	1100	10	11.0	10														
			2	DB160-4C	2	1.6	1724	1433	1400	10	14.0	10																							

HD mode (HP rating motor)

Power supply voltage	Nominal applied motor (HP)	Inverter type	Selecting Options					Maximum braking torque		Continuous braking (100% braking torque)		Repetitive braking (each cycle is 100 s or less)																					
			Braking units		Braking resistor			50Hz	60Hz	Discharging capability	Braking time	Average allowable loss	Duty cycle																				
			Model	Q'ty	Model	Q'ty	Resistance (Ω)	(N·m)	(N·m)	(kW/s)	(s)	(kW)	(%ED)																				
Three-phase 460V	1	FRN0002E2■-4□			DB0.75-4	1	200	5.05	4.17	9	24	0.044	12																				
	1.5	FRN0004E2■-4□																															
	3	FRN0006E2■-4□													DB2.2-4	1	160	14.7	12.1	34	30	0.075	7										
	4	FRN0007E2■-4□																															
	7.5	FRN0012E2■-4□																							DB3.7-4	1	130	36.2	30.0	37	13	0.093	3.5
	10	FRN0022E2■-4□																							DB5.5-4	1	80	49.6	41.0	55	15	0.138	3.5
	15	FRN0029E2■-4□																															
	20	FRN0037E2■-4□																								DB7.5-4	1	60	72.0	59.7	38	7	0.188
	25	FRN0044E2■-4□																															
	30	FRN0059E2■-4□																								DB11-4	1	40	98.1	81.4	55	7	0.275
	40	FRN0072E2■-4□																															
	50	FRN0085E2■-4□												DB15-4	1	34.4	121	100	75	8	0.375	4											
	60	FRN0105E2■-4□	BU37-4C	1	DB18.5-4	1	27	144	119	93	8	0.463	4																				
	75	FRN0139E2■-4□																															
	100	FRN0168E2■-4□												DB30-4C	1	15	195	162	150	10	1.50	10											
	125	FRN0203E2■-4□																															
	150	FRN0240E2■-4□												DB37-4C	1	12	240	200	185	10	1.85	10											
	200	FRN0290E2■-4□	BU55-4C	1	DB45-4C	1	10	293	243	225	10	2.25	10																				
	250	FRN0361E2■-4□																															
	300	FRN0415E2■-4□												DB55-4C	1	7.5	359	298	275	10	2.75	10											
350	FRN0520E2■-4□																																
400	FRN0590E2■-4□												DB75-4C	1	6.5	487	405	375	10	3.75	10												
		BU90-4C	1	DB110-4C	1	4.7	585	486	450	10	4.50	10																					
													BU132-4C	1	DB132-4C	1	3.9	712	592	550	10	5.50	10										
													BU220-4C	1	DB160-4C	1	3.2	855	710	660	10	6.60	10										
													DB200-4C	1	2.6	1036	861	800	10	8.00	10												
													DB220-4C	1	2.2	1295	1076	1000	10	10.0	10												
			2	DB132-4C	2	1.95	1424	1184	1100	10	11.0	10																					
							1710	1420	1320	10	13.2	10																					

Note: A box (■) in the above table replaces S (Basic type) or E (EMC filter built-in type) depending on the enclosure.
A box (□) in the above table replaces GA, GB or C depending on the model.

11.8 Braking Resistors (DBRs) and Braking Units

Table 11.8-7 Braking Unit and Braking Resistor (Standard Model)

HND mode (HP rating motor)

Power supply voltage	Nominal applied motor (HP)	Inverter type	Selecting Options					Maximum braking torque		Continuous braking (100% braking torque)		Repetitive braking (each cycle is 100 s or less)		
			Braking units		Braking resistor			50Hz	60Hz	Discharging capability	Braking time	Average allowable loss	Duty cycle	
			Model	Q'ty	Model	Q'ty	Resistance (Ω)	(N·m)	(N·m)	(kW/s)	(s)	(kW)	(%ED)	
Three-phase 200V	1/4	FRN0001E2■-2□	-			1	100	100	1.34	1.11	9	90	0.037	37
	1/2	FRN0002E2■-2□							2.68	2.21	9	45	0.037	18
	1	FRN0004E2■-2□							5.05	4.17	9	24	0.044	12
	1.5	FRN0006E2■-2□							7.33	6.06	17	30	0.068	12
	3	FRN0010E2■-2□							14.7	12.1	34	30	0.075	7
	4	FRN0012E2■-2□							20.1	16.5	33	22	0.077	5
	7.5	FRN0020E2■-2□							36.2	30.0	37	13	0.093	3.5
	10	FRN0030E2■-2□							49.1	41.0	55	15	0.138	3.5
	15	FRN0040E2■-2□							72.0	59.7	37	7	0.188	3.5
	20	FRN0056E2■-2□							98.1	81.4	55	7	0.275	3.5
	25	FRN0069E2■-2□							121	100	75	8	0.375	4
	30	FRN0088E2■-2□							144	119	92	8	0.463	4
40	FRN0115E2■-2□	216	179	88	6	0.55	3.5							
Three-phase 400V	1	FRN0002E2■-4□	-			1	200	100	5.05	4.17	9	24	0.044	12
	1.5	FRN0004E2■-4□							7.33	6.06	17	30	0.068	12
	3	FRN0006E2■-4□							14.7	12.1	34	30	0.075	7
	4	FRN0007E2■-4□							20.1	16.5	33	22	0.077	5
	7.5	FRN0012E2■-4□							36.2	30.0	37	13	0.093	3.5
	10	FRN0022E2■-4□							49.6	41.0	55	15	0.138	3.5
	15	FRN0029E2■-4□							72.0	59.7	38	7	0.188	3.5
	20	FRN0037E2■-4□							98.1	81.4	55	7	0.275	3.5
	25	FRN0044E2■-4□							121	100	75	8	0.375	4
	30	FRN0059E2■-4□							144	119	93	8	0.463	4
	40	FRN0072E2■-4□							195	162	88	6	0.55	3.5
	50	FRN0085E2■-4□							216	180	150	10	1.50	10
	60	FRN0105E2■-4□							219	182	185	10	1.85	10
	75	FRN0139E2■-4□							269	223	225	10	2.25	10
	100	FRN0168E2■-4□							365	303	275	10	2.75	10
	125	FRN0203E2■-4□							439	364	375	10	3.75	10
	150	FRN0240E2■-4□							534	444	450	10	4.50	10
	200	FRN0290E2■-4□							641	533	550	10	5.50	10
250	FRN0361E2■-4□	777	646	660	10	6.60	10							
300	FRN0415E2■-4□	971	807	800	10	8.00	10							
350	FRN0520E2■-4□	1068	888	1000	10	10.0	10							
400	-	-	-	-	-	-	-							
450	FRN0590E2■-4□	1360	1130	1100	10	11.0	10							
Single-phase 200V	1/4	FRN0001E2■-7□	-			1	100	100	1.34	1.11	9	90	0.037	37
	1/2	FRN0002E2■-7□							2.68	2.21	9	45	0.037	18
	1	FRN0003E2■-7□							5.05	4.17	9	24	0.044	12
	2	FRN0005E2■-7□							7.33	6.06	17	30	0.068	12
	3	FRN0008E2■-7□							14.7	12.1	34	30	0.075	7
	4	FRN0011E2■-7□							20.1	16.5	33	22	0.077	5

Note: A box (■) in the above table replaces S (Basic type) or E (EMC filter built-in type) depending on the enclosure. A box (□) in the above table replaces GA, GB or C depending on the model.

11.8 Braking Resistors (DBRs) and Braking Units

Table 11.8-8 Braking Unit and Braking Resistor (Standard Model)

HHD mode (HP rating motor)

Power supply voltage	Nominal applied motor (HP)	Inverter type	Selecting Options					Maximum braking torque		Continuous braking (100% braking torque)		Repetitive braking (each cycle is 100 s or less)		
			Braking units		Braking resistor			50Hz	60Hz	Discharging capability	Braking time	Average allowable loss	Duty cycle	
			Model	Q'ty	Model	Q'ty	Resistance (Ω)	(N·m)	(N·m)	(kWs)	(s)	(kW)	(%ED)	
Three-phase 200V	1/8	FRN0001E2■-2□	-		DB0.75-2	1	100	150	1.01	0.83	9	90	0.037	37
	1/4	FRN0002E2■-2□							2.01	1.66	9	90	0.037	37
	1/2	FRN0004E2■-2□							4.02	3.32	9	45	0.044	22
	1	FRN0006E2■-2□							7.57	6.25	17	45	0.068	18
	2	FRN0010E2■-2□							15.0	12.4	34	45	0.075	10
	3	FRN0012E2■-2□							22.0	18.2	33	30	0.077	7
	5	FRN0020E2■-2□							37.1	30.5	37	20	0.093	5
	7.5	FRN0030E2■-2□							54.3	45.0	55	20	0.138	5
	10	FRN0040E2■-2□							73.6	61.6	38	10	0.188	5
	15	FRN0056E2■-2□							108	89.5	55	10	0.275	5
	20	FRN0069E2■-2□							147	122	75	10	0.375	5
Three-phase 400V	1/2	FRN0002E2■-4□	-		DB0.75-4	1	200	150	4.02	3.32	9	45	0.044	22
	1	FRN0004E2■-4□							7.57	6.25	17	45	0.068	18
	2	FRN0006E2■-4□							15.0	12.4	34	45	0.075	10
	3	FRN0007E2■-4□							22.0	18.2	33	30	0.077	7
	5	FRN0012E2■-4□							37.1	30.5	37	20	0.093	5
	7.5	FRN0022E2■-4□							54.3	45.0	55	20	0.138	5
	10	FRN0029E2■-4□							73.6	61.6	38	10	0.188	5
	15	FRN0037E2■-4□							108	89.5	55	10	0.275	5
	20	FRN0044E2■-4□							147	122	75	10	0.375	5
	25	FRN0059E2■-4□							182	151	93	10	0.463	5
	30	FRN0072E2■-4□							216	179	88	8	0.55	5
	40	FRN0085E2■-4□							292	243	225	10	2.25	10
	50	FRN0105E2■-4□							359	298	275	10	2.75	10
	60	FRN0139E2■-4□							487	405	375	10	3.75	10
	75	FRN0168E2■-4□							585	486	450	10	4.50	10
	100	FRN0203E2■-4□							712	592	550	10	5.50	10
	125	FRN0240E2■-4□							855	710	660	10	6.60	10
	150	FRN0290E2■-4□							1036	861	800	10	8.00	10
	200	FRN0361E2■-4□							1295	1076	1000	10	10.0	10
250	FRN0415E2■-4□	1424	1184	1100	10	11.0	10							
Single-phase 200V	1/8	FRN0001E2■-7□	-		DB0.75-2	1	100	150	1.01	0.83	9	90	0.037	37
	1/4	FRN0002E2■-7□							2.01	1.66	9	90	0.037	37
	1/2	FRN0003E2■-7□							4.02	3.32	9	45	0.044	22
	1	FRN0005E2■-7□							7.57	6.25	17	45	0.068	18
	2	FRN0008E2■-7□							15.0	12.4	34	45	0.075	10
	3	FRN0011E2■-7□							22.0	18.2	33	30	0.077	7

Note: A box (■) in the above table replaces S (Basic type) or E (EMC filter built-in type) depending on the enclosure.
A box (□) in the above table replaces GA, GB or C depending on the model.

11.8 Braking Resistors (DBRs) and Braking Units

Table 11.8-9 Braking Resistors (10% ED Models)

ND mode (kW/HP rating motor)

Power supply voltage	Nominal applied motor		Inverter type	Selecting Options					Maximum braking torque		Continuous braking (100% braking torque)		Repetitive braking (each cycle is 100 s or less)					
				Braking units		Braking resistor			50Hz	60Hz	Discharging capability	Braking time	Average allowable loss	Duty cycle				
	Model	Q'ty		Model	Q'ty	Resistance (Ω)	(N·m)	(N·m)	(kW)	(s)					(kW)	(%ED)		
Three-phase 400V	0.75	1	FRN0002E2#-4□	-		DB0.75-4C	1	200	75	3.79	3.13	50	133	0.075	20			
	1.5	2	FRN0004E2#-4□							DB2.2-4C	1	160	7.50	6.20	50	66	0.075	10
	2.2	3	FRN0006E2#-4□										11.0	9.10	55	50	0.11	10
	3.0	4	FRN0007E2#-4□							DB3.7-4	1	130	15.0	12.4	55	36	0.11	7
	5.5	7.5	FRN0012E2#-4□										27.2	22.5	140	50	0.185	7
	11	15	FRN0022E2#-4□							DB5.5-4C	1	80	54.0	44.8	55	15	0.275	10
	15	20	FRN0029E2#-4□										73.5	61.0	37	7	0.375	10
	18.5	25	FRN0037E2#-4□							DB7.5-4C	1	60	90.8	75.5	55	7	0.55	10
	22	30	FRN0044E2#-4□										108	89.5	75	7	0.75	7
	30	40	FRN0059E2#-4□							DB11-4C	1	40	146	121	93	6	0.925	6
37	50	FRN0072E2#-4□	180	150	110	6	1.1	6										

HD mode (kW/HP rating motor)

Power supply voltage	Nominal applied motor		Inverter type	Selecting Options					Maximum braking torque		Continuous braking (100% braking torque)		Repetitive braking (each cycle is 100 s or less)					
				Braking units		Braking resistor			50Hz	60Hz	Discharging capability	Braking time	Average allowable loss	Duty cycle				
	Model	Q'ty		Model	Q'ty	Resistance (Ω)	(N·m)	(N·m)	(kW)	(s)					(kW)	(%ED)		
Three-phase 400V	0.75	1	FRN0002E2#-4□	-		DB0.75-4C	1	200	100	5.05	4.17	50	133	0.075	20			
	1.1	1.5	FRN0004E2#-4□							DB2.2-4C	1	160	7.33	6.06	50	90	0.075	13
	2.2	3	FRN0006E2#-4□										14.7	12.1	55	50	0.11	10
	3.0	4	FRN0007E2#-4□							DB3.7-4C	1	130	20.1	16.5	55	36	0.11	7
	5.5	7.5	FRN0012E2#-4□										36.2	30.0	140	50	0.185	7
	7.5	10	FRN0022E2#-4□							DB5.5-4C	1	80	49.6	41.0	55	15	0.275	10
	11	15	FRN0029E2#-4□										72.0	59.7	37	7	0.375	10
	15	20	FRN0037E2#-4□							DB7.5-4C	1	60	98.1	81.4	55	7	0.55	10
	18.5	25	FRN0044E2#-4□										121	100	75	7	0.75	7
	22	30	FRN0059E2#-4□							DB11-4C	1	34.4	144	119	93	7	0.925	7
30	40	FRN0072E2#-4□	195	162	110	7	1.1	7										

HND mode (kW/HP rating motor)

Power supply voltage	Nominal applied motor		Inverter type	Selecting Options					Maximum braking torque		Continuous braking (100% braking torque)		Repetitive braking (each cycle is 100 s or less)					
				Braking units		Braking resistor			50Hz	60Hz	Discharging capability	Braking time	Average allowable loss	Duty cycle				
	Model	Q'ty		Model	Q'ty	Resistance (Ω)	(N·m)	(N·m)	(kW)	(s)					(kW)	(%ED)		
Three-phase 200V	0.2	1/4	FRN0001E2#-2□	-		DB0.75-2C	1	100	100	1.34	1.11	50	500	0.075	75			
	0.4	1/2	FRN0002E2#-2□							DB2.2-2C	1	40	2.68	2.21	50	250	0.075	37
	0.75	1	FRN0004E2#-2□										5.05	4.17	50	133	0.075	20
	1.1	1.5	FRN0006E2#-2□							DB3.7-2C	1	33	7.33	6.06	50	90	0.075	14
	2.2	3	FRN0010E2#-2□										14.7	12.1	55	50	0.11	10
	3.0	4	FRN0012E2#-2□							DB5.5-2C	1	20	20.1	16.5	55	36	0.11	7
	5.5	7.5	FRN0020E2#-2□										36.2	30.0	140	50	0.185	7
	7.5	10	FRN0030E2#-2□							DB7.5-2C	1	15	49.6	41.0	55	15	0.275	10
	11	15	FRN0040E2#-2□										72.0	59.7	37	7	0.375	10
	15	20	FRN0056E2#-2□							DB11-2C	1	10	98.1	81.4	55	7	0.55	10
18.5	25	FRN0069E2#-2□	121	100	75	7	0.75	7										
22	30	FRN0088E2#-2□	DB15-2C	1	8.6	144	119	92	7	0.925	7							
30	40	FRN0115E2#-2□				195	162	110	7	1.1	7							
Three-phase 400V	0.75	1	FRN0002E2#-4□	-		DB0.75-4C	1	200	100	5.05	4.17	50	133	0.075	20			
	1.1	1.5	FRN0004E2#-4□							DB2.2-4C	1	160	7.33	6.06	50	90	0.075	13
	2.2	3	FRN0006E2#-4□										14.7	12.1	55	50	0.11	10
	3.0	4	FRN0007E2#-4□							DB3.7-4C	1	130	20.1	16.5	55	36	0.11	7
	5.5	7.5	FRN0012E2#-4□										36.2	30.0	140	50	0.185	7
	7.5	10	FRN0022E2#-4□							DB5.5-4C	1	80	49.6	41.0	55	15	0.275	10
	11	15	FRN0029E2#-4□										72.0	59.7	37	7	0.375	10
	15	20	FRN0037E2#-4□							DB7.5-4C	1	60	98.1	81.4	55	7	0.55	10
	18.5	25	FRN0044E2#-4□										121	100	75	7	0.75	7
	22	30	FRN0059E2#-4□							DB11-4C	1	34.4	144	119	93	7	0.925	7
30	40	FRN0072E2#-4□	195	162	110	7	1.1	7										
Single-phase 200V	0.2	1/4	FRN0001E2#-7□	-		DB0.75-2C	1	100	100	1.34	1.11	50	500	0.075	75			
	0.4	1/2	FRN0002E2#-7□							2.68	2.21	50	250	0.075	37			
	0.75	1	FRN0003E2#-7□							5.05	4.17	50	133	0.075	20			
	1.5	2	FRN0005E2#-7□							7.33	6.06	50	90	0.075	14			
	2.2	3	FRN0008E2#-7□							14.7	12.1	55	50	0.11	10			
	3.7	5	FRN0011E2#-7□							20.1	16.5	55	36	0.11	7			

11.8 Braking Resistors (DBRs) and Braking Units

Table 11.8-10 Braking Resistors (10% ED Models) (continued)

HHD mode (kW/HP rating motor)

Power supply voltage	Nominal applied motor (kW)		Inverter type	Selecting Options					Maximum braking torque		Continuous braking (100% braking torque)		Repetitive braking (each cycle is 100 s or less)		
				Braking units		Braking resistor			50Hz	60Hz	Discharging capability (kW)	Braking time (s)	Average allowable loss (kW)	Duty cycle (%ED)	
	(kW)	(HP)		Model	Q'ty	Model	Q'ty	Resistance (Ω)	(N·m)	(N·m)					
Three-phase 200V	0.1	1/8	FRN0001E2-2□	-		DB0.75-2C	1	100	150	1.01	0.83	50	1000	0.075	100
	0.2	1/4	FRN0002E2-2□							2.01	1.66	50	500	0.075	75
	0.4	1/2	FRN0004E2-2□							4.02	3.32	50	250	0.075	37
	0.75	1	FRN0006E2-2□							7.57	6.25	50	133	0.075	20
	1.5	2	FRN0010E2-2□							15.0	12.4	55	73	0.110	14
	2.2	3	FRN0012E2-2□							22.0	18.2	55	50	0.110	10
	3.7	5	FRN0020E2-2□							37.1	30.5	140	75	0.185	10
	5.5	7.5	FRN0030E2-2□							54.3	45.0	55	20	0.275	10
	7.5	10	FRN0040E2-2□							73.6	61.6	37	10	0.375	10
	11	15	FRN0056E2-2□							108	89.5	55	10	0.55	10
	15	20	FRN0069E2-2□							147	122	75	10	0.75	10
	18.5	25	FRN0088E2-2□							182	151	92	10	0.925	10
22	30	FRN0115E2-2□	216	179	110	10	1.1	10							
Three-phase 400V	0.4	1/2	FRN0002E2-4□	-		DB0.75-4C	1	200	150	4.02	3.32	50	250	0.075	37
	0.75	1	FRN0004E2-4□							7.57	6.25	50	133	0.075	20
	1.5	2	FRN0006E2-4□							15.0	12.4	55	73	0.110	14
	2.2	3	FRN0007E2-4□							22.0	18.2	55	50	0.110	10
	3.7	5	FRN0012E2-4□							37.1	30.5	140	75	0.185	10
	5.5	7.5	FRN0022E2-4□							54.3	45.0	55	20	0.275	10
	7.5	10	FRN0029E2-4□							73.6	61.6	37	10	0.375	10
	11	15	FRN0037E2-4□							108	89.5	55	10	0.55	10
	15	20	FRN0044E2-4□							147	122	75	10	0.75	10
	18.5	25	FRN0059E2-4□							182	151	92	10	0.925	10
22	30	FRN0072E2-4□	216	179	110	10	1.1	10							
Single-phase 200V	0.1	1/8	FRN0001E2-7□	-		DB0.75-2C	1	100	150	1.01	0.83	50	1000	0.075	100
	0.2	1/4	FRN0002E2-7□							2.01	1.66	50	500	0.075	75
	0.4	1/2	FRN0003E2-7□							4.02	3.32	50	250	0.075	37
	0.75	1	FRN0005E2-7□							7.57	6.25	50	133	0.075	20
	1.5	2	FRN0008E2-7□							15.0	12.4	55	73	0.110	14
	2.2	3	FRN0011E2-7□							22.0	18.2	55	50	0.110	10

Note: A box (■) in the above table replaces S (Basic type) or E (EMC filter built-in type) depending on the enclosure.
A box (□) in the above table replaces GA, GB or C depending on the model.

* The 10%ED braking resistor does not support overheating detection or warning output, so an electronic thermal overload relay needs to be set up using function codes F50 and F51 to protect the braking resistor from overheating.

11.8.5 External dimensions

Braking resistors, standard models

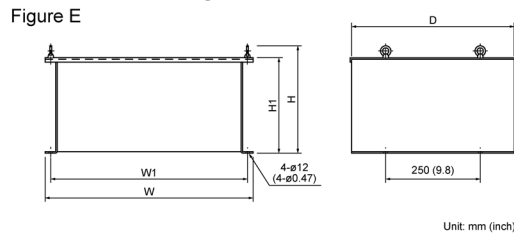
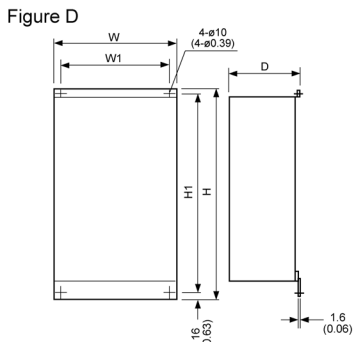
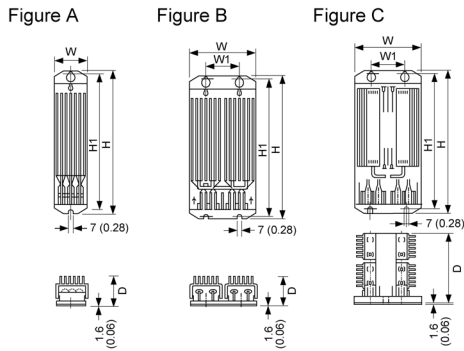

Unit: mm (inch)

Power supply voltage	Type	Figure	Dimensions					Mass kg (lb)
			W	W1	H	H1	D	
200 V series	DB0.75-2	A	68 (2.7)	—	310 (12.2)	295 (11.6)	67 (2.6)	1.3 (2.9)
	DB2.2-2	A	80 (3.2)		345 (13.6)	332 (13.1)	94 (3.7)	2.0 (4.4)
	DB3.7-2	A	80 (3.2)		345 (13.6)	332 (13.1)	94 (3.7)	2.0 (4.4)
	DB5.5-2	B	146 (5.7)	90 (3.5)	450 (17.7)	430 (16.9)	67.5 (2.7)	4.5 (9.9)
	DB7.5-2	B	160 (6.3)	90 (3.5)	390 (15.4)	370 (14.6)	90 (3.5)	5.0 (11)
	DB11-2	C	142 (5.6)	74 (2.9)	430 (16.9)	415 (16.3)	160 (6.3)	6.9 (15)
	DB15-2	C	142 (5.6)	74 (2.9)	430 (16.9)	415 (16.3)	160 (6.3)	6.9 (15)
	DB18.5-2	C	142 (5.6)	74 (2.9)	510 (20.1)	495 (19.5)	160 (6.3)	8.7 (19)
	DB22-2	C	142 (5.6)	74 (2.9)	510 (20.1)	495 (19.5)	160 (6.3)	8.7 (19)
	DB30-2C	D	400 (15.7)	368 (14.5)	660 (26.0)	628 (24.7)	140 (5.5)	10 (22)
	DB37-2C	D					240 (9.4)	13 (29)
	DB45-2C	D					240 (9.4)	18 (40)
	DB55-2C	D					240 (9.4)	22 (49)
	DB75-2C	E	450 (17.7)	420 (16.5)	283 (11.1)	240 (9.4)	440 (17.3)	35 (77)
DB110-2C	E	550 (21.7)	520 (20.5)	32 (71)				
400 V series	DB0.75-4	A	68 (2.7)	—	310 (12.2)	295 (11.6)	67 (2.6)	1.3 (2.9)
	DB2.2-4		68 (2.7)		470 (18.5)	455 (17.9)	67 (2.6)	2.0 (4.4)
	DB3.7-4		68 (2.7)		470 (18.5)	455 (17.9)	67 (2.6)	1.7 (3.7)
	DB5.5-4	B	146 (5.8)	74 (2.9)	470 (18.5)	455 (17.9)	67 (2.6)	4.5 (9.9)
	DB7.5-4		146 (5.8)	74 (2.9)	510 (20.1)	495 (19.5)	67 (2.6)	5.0 (11)
	DB11-4	C	142 (5.6)	74 (2.9)	430 (16.9)	415 (16.3)	160 (6.3)	6.9 (15)
	DB15-4	C	142 (5.6)	74 (2.9)	430 (16.9)	415 (16.3)	160 (6.3)	6.9 (15)
	DB18.5-4	C	142 (5.6)	74 (2.9)	510 (20.1)	495 (19.5)	160 (6.3)	8.7 (19)
	DB22-4	C	142 (5.6)	74 (2.9)	510 (20.1)	495 (19.5)	160 (6.3)	8.7 (19)
	DB30-4C	D	420 (16.5)	388 (15.3)	660 (26.0)	628 (24.7)	140 (5.5)	5.0 (11)
	DB37-4C	D					240 (9.4)	14 (31)
	DB45-4C	D					240 (9.4)	19 (42)
	DB55-4C	D					240 (9.4)	21 (46)
	DB75-4C	E	550 (21.7)	520 (20.5)	283 (11.1)	240 (9.4)	440 (17.3)	26 (57)
DB110-4C	30 (66)							
DB132-4C	650 (25.6)		620 (24.4)	41 (90)				
DB160-4C	750 (29.5)		720 (28.3)	57 (126)				
DB200-4C	43 (95)							
DB220-4C *	600 (23.6)	570 (22.4)	74 (163)					

*: DB220-4C should be used in pairs. The dimension above is for one unit.

Braking resistors, 10% ED models

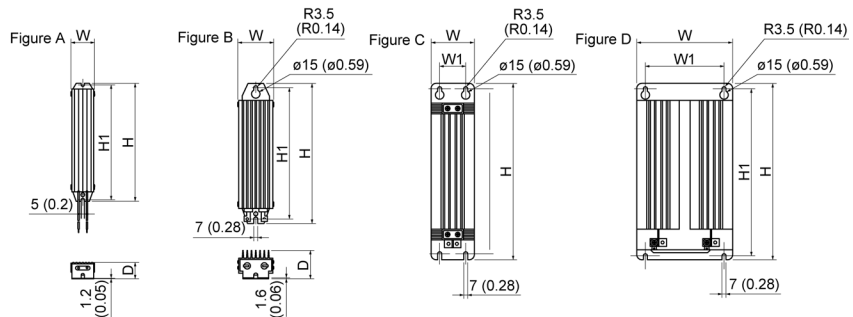

Type	Figure	Dimensions					Mass kg (lb)
		W	W1	H	H1	D	
DB0.75-2C/4C	A	43 (1.7)	—	221 (8.7)	215 (8.5)	30.5 (1.2)	0.4 (0.9)
DB2.2-2C/4C	B	67 (2.6)	—	188 (7.4)	172 (6.8)	55 (2.2)	0.8 (1.8)
DB3.7-2C/4C	B	67 (2.6)	—	328 (12.9)	312 (12.3)	55 (2.2)	1.4 (3.1)
DB5.5-2C/4C	B	80 (3.2)	—	378 (14.9)	362 (14.3)	78 (3.1)	2.6 (5.7)
DB7.5-2C/4C	B	80 (3.2)	—	418 (16.5)	402 (15.8)	78 (3.1)	2.8 (6.2)
DB11-2C/4C	C	80 (3.2)	50 (2.0)	460 (18.1)	440 (17.3)	140 (5.5)	4.3 (9.5)
DB15-2C/4C	C	80 (3.2)	50 (2.0)	580 (22.8)	560 (22.1)	140 (5.5)	5.6 (12)
DB22-2C/4C	D	180 (7.1)	144 (5.7)	400 (15.8)	383 (15.1)	145 (5.7)	8.4 (19)

Unit: mm (inch)

11.8 Braking Resistors (DBRs) and Braking Units

Braking units

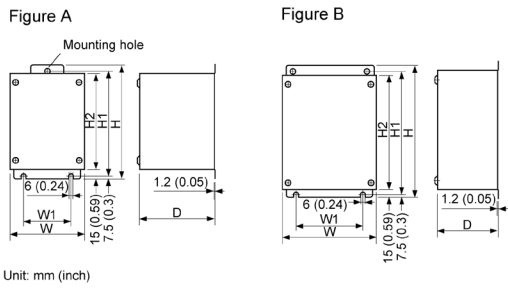

Unit: mm (inch)

Power supply voltage	Type	Figure	Dimensions mm (inch)						Mass kg (lb)
			W	W1	H	H1	H2	D	
200 V series	BU37-2C	A	150 (5.9)	100 (3.9)	240 (9.5)	225 (8.9)	210 (8.3)	160 (6.3)	4 (8.8)
	BU55-2C	B	230 (9.1)	130 (5.1)	240 (9.5)	225 (8.9)			6 (13)
	BU90-2C		250 (9.8)	150 (5.9)	370 (14.6)	355 (14.0)	340 (13.4)	9 (20)	
400 V series	BU37-4C	B	150 (5.9)	100 (3.9)	280 (11.0)	265 (10.4)	250 (9.8)	160 (6.3)	4 (8.8)
	BU55-4C		230 (9.1)	130 (5.1)					5.5 (12)
	BU90-4C		250 (9.8)	150 (5.9)	370 (14.6)	355 (14.0)	340 (13.4)	9 (20)	
	BU220-4C		250 (9.8)	150 (5.9)	450 (17.7)	435 (17.1)	420 (16.5)	13 (29)	

Fan units for braking units

Using this option improves the duty cycle [%ED] from 10%ED to 30%ED.

■ Fan unit

● BU-F

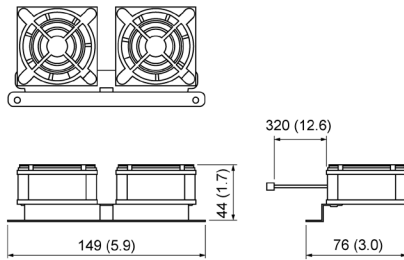

Unit: mm (inch)

■ Braking unit + Fan unit

● BU37 to 220 - 2C/4C + BU-F

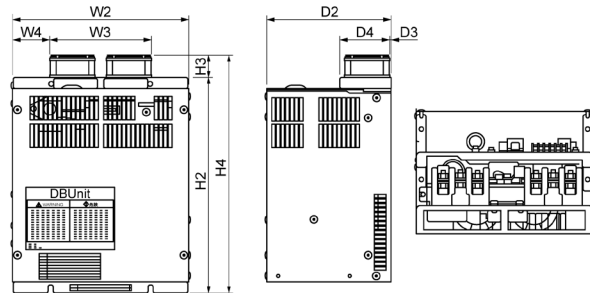

[Braking unit + Fan unit]

Power supply voltage	Type	Dimensions mm (inch)								
		W2	W3	W4	H2	H3	H4	D2	D3	D4
200 V series	BU37-2C+BU-F	150 (5.9)	135 (5.3)	7.5 (0.3)	240 (9.5)	30 (1.2)	270 (10.6)	160 (6.3)	1.2 (0.05)	64 (2.5)
	BU55-2C+BU-F	230 (9.1)		47.5 (1.9)						
	BU90-2C+BU-F	250 (9.8)		57.5 (2.3)	370 (14.6)	400 (15.8)				
400 V series	BU37-4C+BU-F	150 (5.9)	135 (5.3)	7.5 (0.3)	280 (11.0)	30 (1.2)	310 (12.2)	160 (6.3)	1.2 (0.05)	64 (2.5)
	BU55-4C+BU-F	230 (9.1)		47.5 (1.9)						
	BU90-4C+BU-F	250 (9.8)		57.5 (2.3)	370 (14.6)	400 (15.8)				
	BU220-4C+BU-F	250 (9.8)		57.5 (2.3)	450 (17.7)	480 (18.9)				

11.9.2 Specifications

[1] Standard specifications

■ 200 V class series

Item		Standard specifications										
Type RHC□□□-2C		200 V class series										
		7.5	11	15	18.5	22	30	37	45	55	75	90
CT mode	Applicable inverter capacity (kW)	7.5	11	15	18.5	22	30	37	45	55	75	90
	Continuous capacity (kW)	8.8	13	18	22	26	36	44	53	65	88	103
	Overload rating	150% of continuous rating for 1 minute										
	Output Voltage 200 V	320 to 355 VDC (Variable with input power voltage) (*1)										
VT mode	Required power supply (kVA)	9.5	14	19	24	29	38	47	57	70	93	111
	Carrier frequency	15 kHz (typical)										
	Carrier frequency	10 kHz (typical)										
	Applicable inverter capacity (kW)	11	15	18.5	22	30	37	45	55	75	90	110
VT mode	Continuous capacity (kW)	13	18	22	26	36	44	53	65	88	103	126
	Overload rating	120% of continuous rating for 1 minute										
	Output Voltage 200 V	320 to 355 VDC (Variable with input power voltage) (*1)										
	Required power supply (kVA)	14	19	24	29	38	47	57	70	93	111	136
Input power	Carrier frequency	10 kHz (typical)										
	Carrier frequency	6 kHz (typical)										
	Number of phases, voltage, frequency	Three-phase three lines, 200 to 220 V 50 Hz, 220 to 230 V 50 Hz (*2), 200 to 230 V 60 Hz										
Voltage/frequency fluctuation		Voltage: -15 to +10%, Frequency: ±5%, Voltage unbalance: 2% or less (*3)										

■ 400 V class series

Item		Standard specifications																						
Type RHC□□□-4C		400 V class series																						
		7.5	11	15	18.5	22	30	37	45	55	75	90	110	132	160	200	220	280	315	355	400	500	630	
CT mode	Applicable inverter capacity (kW)	7.5	11	15	18.5	22	30	37	45	55	75	90	110	132	160	200	220	280	315	355	400	500	630	
	Continuous capacity (kW)	8.8	13	18	22	26	36	44	53	65	88	103	126	150	182	227	247	314	353	400	448	560	705	
	Overload rating	150% of continuous rating for 1 min																						
	Output Voltage 200 V	640 to 710 V (Variable with input power voltage) (*1)																						
VT mode	Required power supply (kVA)	9.5	14	19	24	29	38	47	57	70	93	111	136	161	196	244	267	341	383	433	488	610	762	
	Carrier frequency	15 kHz (typical)										10 kHz (typical)										6 kHz (typical)		
	Carrier frequency	10 kHz (typical)																						
	Carrier frequency	6 kHz (typical)																						
VT mode	Applicable inverter capacity (kW)	11	15	18.5	22	30	37	45	55	75	90	110	132	160	200	220	280	315	355	400	500			
	Continuous capacity (kW)	13	18	22	26	36	44	53	65	88	103	126	150	182	227	247	314	353	400	448	560			
	Overload rating	120% of continuous rating for 1 min																						
	Output Voltage 200 V	640 to 710 V (Variable with input power voltage) (*1)																						
Input power	Required power supply (kVA)	14	19	24	29	38	47	57	70	93	111	136	161	196	244	267	341	383	433	488	610			
	Carrier frequency	10 kHz (typical)										6 kHz (typical)												
	Carrier frequency	6 kHz (typical)																						
Number of phases, voltage, frequency		Three-phase three lines, 380 to 440 V 50 Hz, 380 to 460 V 60 Hz (*4)																						
Voltage/frequency fluctuation		Voltage: -15 to +10%, Frequency: ±5%, Voltage unbalance: 2% or less (*3)																						

(*1) When the power supply voltage is 200/400 V, 220/440 V, or 230/460 V, the output voltage is approximate 320/640 VDC, 343/686 VDC, 355/710 VDC, respectively.

(*2) The 220 to 230 V/50 Hz models are available on request.

(*3) Voltage unbalance (%) = (Max. voltage (V) - Min. voltage (V)) / Three-phase average voltage (V) x 67

(*4) When the power supply voltage is 380 to 398 V/50 Hz and 380 to 430 V/60 Hz, tap-switching is required in the converter.

[2] Common specifications

	Item	Specifications
Control	Control method	AVR constant control with DC ACR minor
	Running/Stopping	Starts rectification when the converter is powered ON after connection. Starts boosting when it receives a run signal (terminals [RUN] and [CM] short-circuited or a run command via the communications link). After that, the converter is ready to run.
	Running status signal	Running, power running, regenerative operation, ready-to-run, alarm output (for any alarm), etc.
	CT/VT switching	Switching between CT and VT modes. CT: 150% of overload rating for 1 min VT: 120% of overload rating for 1 min
	Carrier frequency	Fixed to high carrier frequency
	Input power factor	0.99 or above
	Restart after momentary power failure	Stops the gates (boosting) when the voltage level reaches the undervoltage level if a momentary power failure occurs, and the converter can automatically restart after the power recovers.
	Power limiting control	Controls the power not to exceed the preset limit value.
Indication	Alarm display (Protective functions)	AC fuse blown, AC overvoltage, AC undervoltage, AC overcurrent, AC input current error, input phase loss, synchronous power supply frequency error, DC fuse blown, DC overvoltage, DC undervoltage, charge circuit fault, heat sink overheat, external alarm, converter internal overheat, overload, memory error, keypad communications error, CPU error, network device error, operation procedure error, A/D converter error, optical network error, IPM error
	Alarm history	Saves and displays the most recent 10 alarms. Saves and displays the detailed information of the trip cause for the previous alarm.
	Monitor	Displays input power, input current in RMS, input voltage in RMS, DC link bus voltage and power supply frequency.
	Load factor	Allows the user to measure the load factor with the keypad.
	Language	Allows the user to check and modify function codes in any of the three languages--Japanese, English or Chinese.
	Charging lamp	Lights when the DC link bus capacitor is charged.

11.9.3 Function specifications

■ Terminal functions

Classification	Symbol	Name	Functions
Main circuit	L1/R, L2/S, L3/T	Main circuit power inputs	Connects with the three-phase input power lines through a dedicated reactor.
	P(+), N(-)	Converter outputs	Connects with the power input terminals P(+) and N(-) on an inverter.
	ok	Grounding	Grounding terminal for the converter's chassis (or enclosure).
	R0, T0	Auxiliary power input for the control circuit	For the backup of the control circuit power supply, connect the power lines same as that of the main power input.
Voltage detection	R1, S1, T1	Synchronous power input for voltage detection	Voltage detection terminals for the internal control of the converter. Connect with the power supply side of the dedicated reactor or filter.
	R2, T2	Inputs for control monitoring	Detection terminal for AC fuse blown.
Input signal	[RUN]	Run command	Short-circuiting terminals [RUN] and [CM] runs the converter; opening them stops the converter.
	[RST]	Reset alarm command	When the converter stops due to an alarm, removing the alarm factor and short-circuiting the terminals [RST] and [CM] cancels the protective function, restarting the converter.
	[X1]	General-purpose transistor input	0: Enable external alarm trip THR 1: Cancel current limiter LMT-CCL 2: 73 answerback 73ANS 3: Switch current limiter I-LIM 4: Option DI OPT-DI
	[CM]	Digital input common	Common terminal for digital input signals.
	[PLC]	PLC signal power	Connects to PLC output signal power supply. (Rated voltage: 24 VDC (22 to 27 VDC))
Output signal	[30A/B/C]	Alarm relay output (for any alarm)	Outputs a signal when the protective function is activated to stop the converter. (Contact: [1C], Terminals [30A] and [30C] are closed: Signal ON) (Contact rating: 250 VAC, max. 50 mA)
	[Y1], [Y2], [Y3], [Y11] to [Y18]	General-purpose transistor output	0: Converter running RUN 1: Converter ready to run RDY 2: Power supply current limiting IL 3: Lifetime alarm LIFE 4: Heat sink overheat early warning PRE-OH 5: Overload early warning PRE-OL 6: Power running DRV 7: Regenerating REG 8: Current limiting early warning CUR 9: Restarting after momentary power failure U-RES 10: Synchronizing power supply frequency SY-HZ 11: Alarm content 1 AL1 12: Alarm content 2 AL2 13: Alarm content 4 AL4 14: Option DO OPT-DO * Mounting the OPC-VG7-DIOA option makes 8 points of DO extended functions available. (DI functions are not available.)
	[CME]	Digital output common	
	[Y5A/C]	Relay output	
	[A01], [A04], [A05]	General-purpose analog output	0: Input power PWR 1: Input current in RMS I-AC 2: Input voltage in RMS V-AC 3: DC link bus voltage V-DC 4: Power supply frequency FREQ 5: +10 V test P10 6: -10 V test N10 * Mounting the OPC-VG7-AIO option makes 2 points of AO extended functions available. (AI functions are not available.)
	[M]	Analog output common	Common terminal for analog output signal.
	[73A], [73C]	Charging resistor input relay outputs	Control output for the input relay of the external charging resistor (73).

■ Communications specifications

Item	Specifications	
General communication specifications	Monitoring the running information, running status and function code data, and controlling (selecting) the terminals [RUN], [RST] and [X1]. * Writing to function codes is not possible.	
RS-485 (standard)	Communicating with a PC or PLC. (The converter supports the Fuji general-purpose inverter protocol and Modbus RTU protocol.)	
T-Link (option)	Mounting the OPC-VG7-TL option enables communication with a T-Link module of MICREX-F or MICREX-SX via a T-Link network.	
SX-bus (option)	Mounting the OPC-VG7-SX option enables communication with a MICREX-SX via an SX bus network.	
CC-Link (option)	Mounting the OPC-VG7-CCL option enables communication with a CC-Link master.	
Traceback (option)	Hardware	Mounting the OPC-RHC-TR option enables tracing back of the running status data of the converter. WPS-LD-TR software is required.
	Software	Installing the WPS-RHC-TR software enables collecting of traceback data on the PC.

■ Function settings

Function code	Name
F00	Data protection
F01	High frequency filter selection
F02	Restart mode after momentary power failure (Mode selection)
F03	Current rating switching
F04	LED monitor, item selection
F05	LCD monitor, item selection
F06	LCD monitor, language selection
F07	LCD monitor, contrast control
F08	Carrier frequency
E01	Terminal [X1] function
E02 to E13	Terminal [Y1], [Y2], [Y3.], [Y5], [Y11] to [Y18] function
E14	I/O function normal open/closed
E15	RHC overload early warning level
E16	Cooling fan ON/OFF control
E17	Under current limiting (Hysteresis width)
E18 to E20	A01, A04 and A05, function selection
E21 to E23	A01, A04 and A05, gain setting
E24 to E26	A01, A04 and A05, bias setting
E27	A01, A04 and A05, filter setting
S01	Operation method
S02, S03	Power supply current limiting (driving/braking)
H01	Station address
H02	Communications error processing
H03	Timer
H04	Baud rate
H05	Data length
H06	Parity bits
H07	Stop bits
H08	No-response error detection time
H09	Response interval
H10	Protocol selection
H11	TL transmission format
H12	Parallel system
H13	Number of slave stations in parallel system
H14	Clear alarm data
H15, H16	Power supply current limiter (driving 1/2)
H17, H18	Power supply current limiter (braking 1/2)
H19, H20	Current limiting early warning (level/timer)
M09	Power supply frequency
M10	Input power
M11	Input current in RMS
M12	Input voltage in RMS
M13	Run command
M14	Running status
M15	Output terminals [Y1] to [Y18]

■ Protective functions

Item	LED monitor displays:	Description	Remarks
AC fuse blown	<i>RCF</i>	Stops the converter output if the AC fuse (R-T-phase only) is blown.	
AC overvoltage	<i>ROV</i>	Stops the converter output upon detection of an AC overvoltage condition.	
AC undervoltage	<i>RUU</i>	Stops the converter output upon detection of an AC undervoltage condition.	
AC overcurrent	<i>ROC</i>	Stops the converter output if the peak value of the input current exceeds the overcurrent level.	
AC input current error	<i>RCE</i>	Stops the converter output upon detection of the excessive deviation of the AC reactor from the AC input.	
Input phase loss	<i>LPU</i>	Stops the converter output upon detection of an input phase loss.	
Synchronous power frequency error	<i>FRE</i>	After the MC for charging circuit (73) is turned on, the converter checks the power frequency. If it detects a power frequency error, this function stops the converter output. An error during converter running (e.g., momentary power failure) triggers no alarm.	
DC fuse blown	<i>DCF</i>	Stops the converter output if the DC fuse (P side) is blown.	18.5 kW or above
DC overvoltage	<i>DOV</i>	Stops the converter output upon detection of a DC overvoltage condition. If a power failure continues for a long time and the control power source is shut down, this alarm is automatically reset.	200 V class series: 400 V ± 3 V 400 V class series: 800 V ± 5 V
DC undervoltage	<i>DUU</i>	Stops the converter output upon detection of a DC undervoltage condition. If a power failure continues for a long time and the control power source is shut down, this alarm is automatically reset.	200 V class series: Stops at 185 V, restarts at 208 V. 400 V class series: Stops at 371 V, restarts at 417 V.
Charging circuit fault	<i>PBF</i>	Stops the converter output upon detection of a charging circuit fault, provided that the answerback signal from 73 is enabled.	Condition: 73ANS (Answerback from 73) is assigned to terminal [X1].
Heat sink overheat	<i>OHI</i>	Stops the converter output upon detection of a heat sink overheat.	
External alarm	<i>OHA</i>	Stops the converter output upon receipt of an external signal THR .	Condition: THR (Enable external alarm trip) is assigned to terminal [X1].
Converter internal overheat	<i>OHS</i>	Stops the converter output upon detection of an internal overheat of the converter.	
Converter overload	<i>OLU</i>	Stops the converter output with the inverse-time characteristics due to the input current.	Activate at 105%, 150% for 1 min
Memory error	<i>Er-1</i>	Stops the converter output if a data writing error or any other memory error occurs (when the checksums of the EEPROM and RAM do not match).	
Keypad communications error	<i>Er-2</i>	Displays " <i>Er-2</i> " upon detection of a wire break in initial communication with the keypad. This does not affect the converter operation.	
CPU error	<i>Er-3</i>	Activated if a CPU error occurs.	
Network device error	<i>Er-4</i>	Stops the converter output if a fatal error (including no power supply connection) occurs in the master unit in the network.	Applies to T-Link, SX-bus, and CC-Link devices.
Operation procedure error	<i>Er-5</i>	Stops the converter output upon detection of an error in the operation procedure.	
A/D converter error	<i>Er-8</i>	Stops the converter output upon detection of a failure in the A/D converter circuit.	
Optical network error	<i>Er-b</i>	Stops the converter output upon detection of an optical cable break or a fatal error in the optical option.	
IPM error	<i>IPF</i>	Activated when the IPM's self-diagnosis function works due to an overcurrent or overheat.	15 kW or below

■ Required structure and environment

	Item	Required structure, environment and standards	Remarks
Structure	Structure	Mounting in a panel or mounting for external cooling	
	Enclosure	IP00	
	Cooling system	Forced air cooling	
	Installation	Vertical installation	
	Coating color	Munsell 5Y3/0.5, eggshell (Same color as our inverter FRENIC 5000VG7S series.)	
	Maintainability	Structure designed for easy parts replacement	
Environment	Site location	Shall be free from corrosive gases, flammable gases, dusts, and direct sunlight. Indoor use only.	
	Surrounding temperature	-10 to 50°C	
	Relative humidity	5 to 95% RH (No condensation)	
	Altitude	3,000 m max. (For use in an altitude between 1,001 m to 3,000 m, the output current should be derated.)	
	Vibration	2 to 9 Hz: Amplitude = 3 mm, 9 to 20 Hz: 9.8 m/s ² , 20 to 55 Hz: 2 m/s ² (9 to 55 Hz: 2 m/s ² for 90 kW or above), 55 to 200 Hz: 1 m/s ²	
	Storage temperature	-20 to 55°C	
	Storage humidity	5 to 95% RH	

11.9.4 Converter configuration

■ List of configurators

CT mode

Power supply	Nominal applied motor (kW)	PWM converter type	MC for charging circuit		MC for power supply		Charging box ^(*)						Boosting reactor		Filtering resistor		Filtering reactor		Filtering capacitor		MC for filtering circuit		
			(73)	Qty	(52)	Qty	(CU)	Charging resistor		Fuse (F)	Qty	(Lr)	Qty	(Rf)	Qty	(Lf)	Qty	(Cf)	Qty	(6F)	Qty		
								(R0)	Qty														
200 V class series	7.5	RHC7.5-2C	SC-5-1	1			CU7.5-2C	1	(80W 7.5Ω)	(3)	(CR2LS-50/UL)	(2)	LR2-7.5C	1	GRZG80 0.42Ω	3	LFC2-7.5C	1	CF2-7.5C	1			
	11	RHC11-2C	SC-N1	1			CU11-2C	1	(HF5C5504)	(3)	(CR2LS-75/UL)	(2)	LR2-15C	1	GRZG150 0.2Ω	3	LFC2-15C	1	CF2-15C	1			
	15	RHC15-2C	SC-N2	1			CU15-2C	1		(3)	(CR2LS-100/UL)	(2)											
	18.5	RHC18.5-2C	SC-N3	1			CU18.5-2C	1	(GRZG120 2Ω)	(3)			LR2-22C	1	GRZG200 0.13Ω	3	LFC2-22C	1	CF2-22C	1			
	22	RHC22-2C					CU22-2C	1		(3)	(CR2L-150/UL)	(2)											
	30	RHC30-2C	SC-N4	1			CU30-2C	1		(3)	(CR2L-200/UL)	(2)	LR2-37C	1	GRZG400 0.1Ω	3	LFC2-37C	1	CF2-37C	1			
	37	RHC37-2C	SC-N5	1			CU45-2C	1		(3)	(CR2L-260/UL)	(2)											
	45	RHC45-2C	SC-N7	1						(3)			LR2-55C	1				LFC2-55C	1	CF2-55C	1		
	55	RHC55-2C	SC-N8	1			CU55-2C	1		(3)	(CR2L-400/UL)	(2)						LFC2-75C	1	CF2-75C	1		
	75	RHC75-2C	SC-N11	1			CU75-2C	1		(3)			LR2-75C	1				LFC2-110C	1	CF2-110C	1		
90	RHC90-2C					CU90-2C	1	(GRZG400 1Ω)	(3)	(A50P600-4)	(2)	LR2-110C	1	GRZG400 0.12Ω (2 pcs in parallel)	6	LFC2-110C	1	CF2-110C	1				
400 V class series	7.5	RHC7.5-4C	SC-05	1			CU7.5-4C	1	(TK50B 30Ω J)	(3)	(CR6L-30/UL)	(2)	LR4-7.5C	1	GRZG80 1.74Ω	3	LFC4-7.5C	1	CF4-7.5C	1			
	11	RHC11-4C	SC-4-0	1			CU15-4C	1	(HF5B0416)	(3)	(CR6L-50/UL)	(2)	LR4-15C	1	GRZG150 0.79Ω	3	LFC4-15C	1	CF4-15C	1			
	15	RHC15-4C	SC-5-1	1						(3)			LR4-22C	1	GRZG200 0.53Ω	3	LFC4-22C	1	CF4-22C	1			
	18.5	RHC18.5-4C	SC-N1	1			CU18.5-4C	1	(80W 7.5Ω)	(3)													
	22	RHC22-4C					CU22-4C	1	(HF5C0416)	(3)	(CR6L-75/UL)	(2)											
	30	RHC30-4C	SC-N2	1			CU30-4C	1		(3)	(CR6L-100/UL)	(2)	LR4-37C	1	GRZG400 0.38Ω	3	LFC4-37C	1	CF4-37C	1			
	37	RHC37-4C	SC-N2S	1			CU45-4C	1		(3)	(CR6L-150/UL)	(2)											
	45	RHC45-4C	SC-N3	1						(3)			LR4-55C	1	GRZG400 0.26Ω	3	LFC4-55C	1	CF4-55C	1			
	55	RHC55-4C	SC-N4	1			CU55-4C	1		(3)	(CR6L-200/UL)	(2)											
	75	RHC75-4C	SC-N5	1			CU75-4C	1		(3)	(CR6L-300/UL)	(2)	LR4-75C	1	GRZG400 0.38Ω	3	LFC4-75C	1	CF4-75C	1			
	90	RHC90-4C	SC-N7	1			CU90-4C	1		(3)			LR4-110C	1	GRZG400 0.53Ω (2 pcs in parallel)	6	LFC4-110C	1	CF4-110C	1			
	110	RHC110-4C	SC-N8	1			CU110-4C	1	(GRZG120 2Ω)	(3)													
	132	RHC132-4C					CU132-4C	1		(3)	(A50P400-4)	(2)	LR4-160C	1	RF4-160C	1	LFC4-160C	1	CF4-160C	1			
	160	RHC160-4C	SC-N11	1			CU160-4C	1		(3)	(A50P600-4)	(2)											
	200	RHC200-4C	SC-N12	1			CU200-4C	1	(GRZG400 1Ω)	(3)			LR4-220C	1	RF4-220C	1	LFC4-220C	1	CF4-220C	1			
	220	RHC220-4C					CU220-4C	1		(3)	(A70QS800-4)	(2)											
	280	RHC280-4C	SC-N3	1	SC-N14	1			GRZG400 1Ω (2 pcs in parallel)	6	A70QS800-4	2	LR4-280C	1	RF4-280C	1	LFC4-280C	1	CF4-280C	1	SC-N4	1	
	315	RHC315-4C								6	A70P1600-4TA	2	LR4-315C	1	RF4-315C	1	LFC4-315C	1	CF4-315C	1			
	355	RHC355-4C								2	LR4-355C	1	RF4-355C	1	LFC4-355C	1	CF4-355C	1					
	400	RHC400-4C			SC-N16	1				2	LR4-400C	1	RF4-400C	1	LFC4-400C	1	CF4-400C	1					
500	RHC500-4C			SC-N11	3				2	LR4-500C	1	RF4-500C	1	LFC4-500C	1	CF4-500C	1	CF4-500C	1 ^(*)	SC-N4 ^(*)	1		
630	RHC630-4C			SC-N12	3				2	LR4-630C	1	RF4-630C	1	LFC4-630C	1	CF4-630C	1	CF4-630C	1 ^(*)	SC-N7 ^(*)	1		

VT mode

Power supply	Nominal applied motor (kW)	PWM converter type	MC for charging circuit		MC for power supply		Charging box ^(*)						Boosting reactor		Filtering resistor		Filtering reactor		Filtering capacitor		MC for filtering circuit			
			(73)	Qty	(52)	Qty	(CU)	Charging resistor		Fuse (F)	Qty	(Lr)	Qty	(Rf)	Qty	(Lf)	Qty	(Cf)	Qty	(6F)	Qty			
								(R0)	Qty															
200 V class series	11	RHC7.5-2C	SC-N1	1			CU7.5-2C	1	(80W 7.5Ω)	(3)	(CR2LS-50/UL)	(2)	LR2-15C	1	GRZG150 0.2Ω	3	LFC2-15C	1	CF2-15C	1				
	15	RHC11-2C	SC-N2	1			CU11-2C	1	(HF5C5504)	(3)	(CR2LS-75/UL)	(2)												
	18.5	RHC15-2C	SC-N3	1			CU15-2C	1		(3)	(CR2LS-100/UL)	(2)	LR2-22C	1	GRZG200 0.13Ω	3	LFC2-22C	1	CF2-22C	1				
	22	RHC18.5-2C					CU18.5-2C	1	(GRZG120 2Ω)	(3)														
	30	RHC22-2C	SC-N4	1			CU22-2C	1		(3)	(CR2L-150/UL)	(2)	LR2-37C	1	GRZG400 0.1Ω	3	LFC2-37C	1	CF2-37C	1				
	37	RHC30-2C	SC-N5	1			CU30-2C	1		(3)	(CR2L-200/UL)	(2)												
	45	RHC37-2C	SC-N7	1			CU45-2C	1		(3)	(CR2L-260/UL)	(2)	LR2-55C	1				LFC2-55C	1	CF2-55C	1			
	55	RHC45-2C	SC-N8	1						(3)									LFC2-75C	1	CF2-75C	1		
	75	RHC55-2C	SC-N11	1			CU55-2C	1		(3)	(CR2L-400/UL)	(2)	LR2-75C	1				LFC2-110C	1	CF2-110C	1			
	90	RHC75-2C					CU75-2C	1		(3)			LR2-110C	1	GRZG400 0.12Ω (2 pcs in parallel)	6	LFC2-110C	1	CF2-110C	1				
110	RHC90-2C	SC-N12	1			CU90-2C	1	(GRZG400 1Ω)	(3)	(A50P600-4)	(2)													
400 V class series	11	RHC7.5-4C	SC-4-0	1			CU7.5-4C	1	(TK50B 30Ω J)	(3)	(CR6L-30/UL)	(2)	LR4-15C	1	GRZG150 0.79Ω	3	LFC4-15C	1	CF4-15C	1				
	15	RHC11-4C	SC-5-1	1			CU15-4C	1	(HF5B0416)	(3)	(CR6L-50/UL)	(2)												
	18.5	RHC15-4C	SC-N1	1						(3)			LR4-22C	1	GRZG200 0.53Ω	3	LFC4-22C	1	CF4-22C	1				
	22	RHC18.5-4C					CU18.5-4C	1	(80W 7.5Ω)	(3)														
	30	RHC22-4C	SC-N2	1			CU22-4C	1	(HF5C5504)	(3)	(CR6L-75/UL)	(2)	LR4-37C	1	GRZG400 0.38Ω	3	LFC4-37C	1	CF4-37C	1				
	37	RHC30-4C	SC-N2S	1			CU30-4C	1		(3)	(CR6L-100/UL)	(2)												
	45	RHC37-4C	SC-N3	1			CU45-4C	1		(3)	(CR6L-150/UL)	(2)	LR4-55C	1	GRZG400 0.26Ω	3	LFC4-55C	1	CF4-55C	1				
	55	RHC45-4C	SC-N4	1						(3)														
	75	RHC55-4C	SC-N5	1			CU55-4C	1		(3)	(CR6L-200/UL)	(2)	LR4-75C	1	GRZG400 0.38Ω	3	LFC4-75C	1	CF4-75C	1				
	90	RHC75-4C	SC-N7	1			CU75-4C	1		(3)	(CR6L-300/UL)	(2)	LR4-110C	1	GRZG400 0.53Ω (2 pcs in parallel)	6	LFC4-110C	1	CF4-110C	1				
110	RHC90-4C	SC-N8	1			CU90-4C	1		(3)															
132	RHC110-4C					CU110-4C	1	(GRZG120 2Ω)	(3)			LR4-160C	1	RF4-160C	1	LFC4-160C	1	CF4-160C	1					
160	RHC132-4C	SC-N11	1			CU132-4C	1		(3)	(A50P400-4)	(2)													
200	RHC160-4C	SC-N12	1			CU160-4C	1		(3)	(A50P600-4)	(2)	LR4-220C	1	RF4-220C	1	LFC4-220C	1	CF4-220C	1					
220	RHC200-4C					CU200-4C	1	(GRZG400 1Ω)	(3)															
280	RHC220-4C	SC-N14	1			CU220-4C	1		(3)	(A70QS800-4)	(2)	LR4-280C	1	RF4-280C	1	LFC4-280C	1	CF4-280C	1					
315	RHC280-4C	SC-N3	1	SC-N14	1			GRZG400 1Ω (2 pcs in parallel)	6	A70QS800-4	2	LR4-315C	1	RF4-315C	1	LFC4-315C	1	CF4-315C	1	SC-N4	1			
355	RHC315-4C								2	LR4-355C	1	RF4-355C	1	LFC4-355C	1	CF4-355C	1							

■ Basic connection diagrams

- RHC7.5-2C to RHC90-2C (Applicable inverters: Three-phase 200 V class series, 7.5 to 90 kW)
- RHC7.5-4C to RHC220-4C (Applicable inverters: Three-phase 400 V class series, 7.5 to 220 kW)

*When a charging box is used

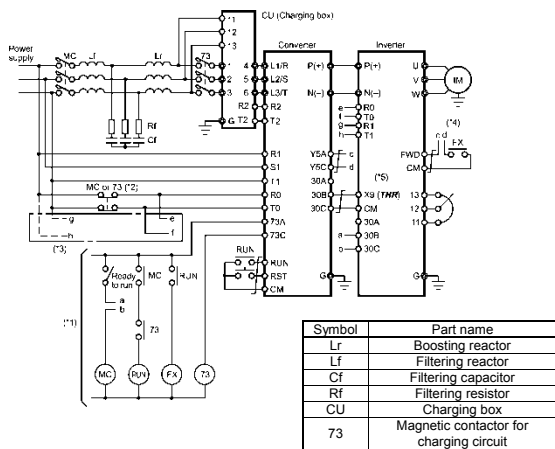

- RHC7.5-2C to RHC90-2C (Applicable inverters: Three-phase 200 V class series, 7.5 to 90 kW)
- RHC7.5-4C to RHC220-4C (Applicable inverters: Three-phase 400 V class series, 7.5 to 220 kW)

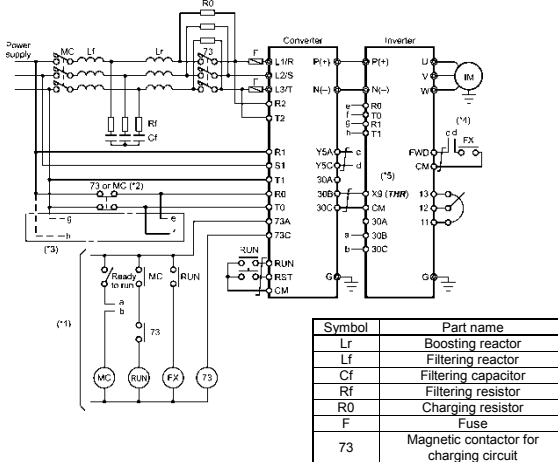

- (*)1 For the 400 V class power supply, connect a stepdown transformer to limit the voltage of the sequence circuit to 220 V or below.
- (*)2 Be sure to connect the auxiliary power input terminals R0 and T0 of the PWM converter to the main power input lines via B (NC) contacts of magnetic contactors of the charging circuit (73 or MC).
- If 73 uses SC-05, SC-4-0, or SC-5-1, connect an auxiliary contact unit to the MC's B contact or 73.
- (*)3 Be sure to connect the auxiliary power input terminals R0 and T0 of the inverter to the main power input lines via B (NC) contacts of magnetic contactors of the charging circuit (73 or MC). For 200 V class series of inverters with a capacity of 37 kW or above and 400 V class series with a capacity of 75 kW or above, connect the fan power input terminals R1 and T1 of the inverter to the main power input lines without going through the MC's B (NC) contacts or 73.
- (*)4 Construct a sequence in which a run command is given to the inverter after the PWM converter becomes ready to run.
- (*)5 Assign the external alarm **THR** to any of terminals [X1] to [X5] on the inverter.

- (*)1 For the 400 V class power supply, connect a stepdown transformer to limit the voltage of the sequence circuit to 220 V or below.
- (*)2 Be sure to connect the auxiliary power input terminals R0 and T0 of the PWM converter to the main power input lines via B (NC) contacts of magnetic contactors of the charging circuit (73 or MC).
- If 73 uses SC-05, SC-4-0, or SC-5-1, connect an auxiliary contact unit to the MC's B contact or 73.
- (*)3 Be sure to connect the auxiliary power input terminals R0 and T0 of the inverter to the main power input lines via B (NC) contacts of magnetic contactors of the charging circuit (73 or MC). For 200 V class series of inverters with a capacity of 37 kW or above and 400 V class series with a capacity of 75 kW or above, connect the fan power input terminals R1 and T1 of the inverter to the main power input lines without going through the MC's B (NC) contacts or 73.
- (*)4 Construct a sequence in which a run command is given to the inverter after the PWM converter becomes ready to run.
- (*)5 Assign the external alarm **THR** to any of terminals [X1] to [X5] on the inverter.

- RHC280-4C to RHC400-4C (Applicable inverters: Three-phase 400 V, 280 to 400 kW)

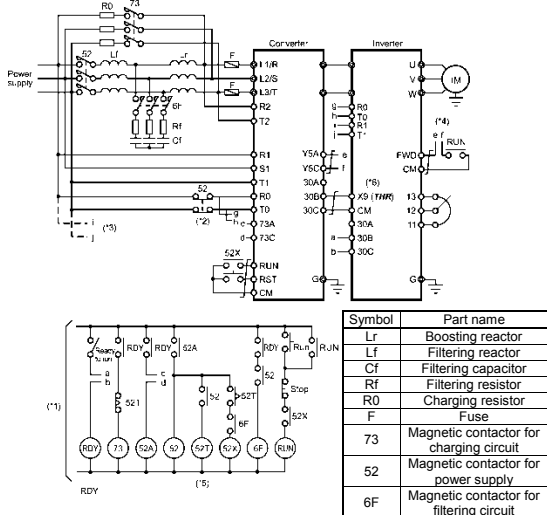

- (*)1 Connect a stepdown transformer to limit the voltage of the sequence circuit to 220 V or below.
- (*)2 Be sure to connect the auxiliary power input terminals R0 and T0 of the PWM converter and the inverter to the main power input lines via B (NC) contacts of magnetic contactors of the power supply circuit (52).
- (*)3 Connect the fan power input terminals R1 and T1 of the inverter to the main power input lines without going through the B (NC) contacts of 52, since the inverter's AC fans are supplied with power from these terminals.
- (*)4 Construct a sequence in which a run command is given to the inverter after the PWM converter becomes ready to run.
- (*)5 Set the timer 52T to 1.
- (*)6 Assign the external alarm **THR** to any of terminals [X1] to [X5] on the inverter.

- RHC400-4C in VT mode (Applicable inverters: Three-phase 400 V, 400 kW)
- RHC500-4C and RHC630-4C (Applicable inverters: Three-phase 400 V, 500 and 630 kW)

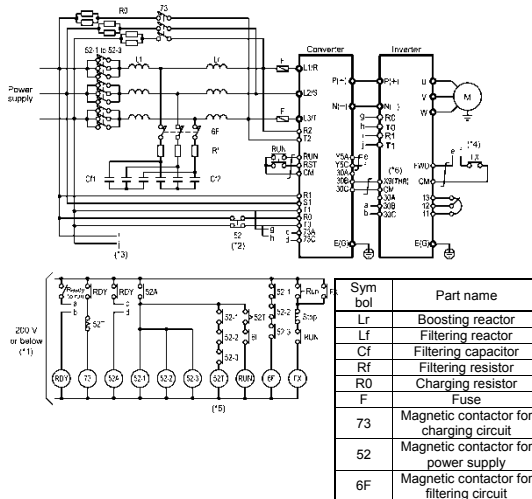

- (*)1 Connect a stepdown transformer to limit the voltage of the sequence circuit to 220 V or below.
- (*)2 Be sure to connect the auxiliary power input terminals R0 and T0 of the PWM converter and the inverter to the main power input lines via B (NC) contacts of magnetic contactors of the power supply circuit (52).
- (*)3 Connect the fan power input terminals R1 and T1 of the inverter to the main power input lines without going through the B (NC) contacts of 73 or 52, since the inverter's AC fans are supplied with power from these terminals.
- (*)4 Construct a sequence in which a run command is given to the inverter after the PWM converter becomes ready to run.
- (*)5 Set the timer 52T to 1.
- (*)6 Assign the external alarm **THR** to any of terminals [X1] to [X5] on the inverter.
- (*)7 Wiring for terminals L1/R, L2/S, L3/T, R2, T2, R1, S1, and T1 should match with the phase sequence.

11.9.5 External dimensions

PWM converter

Figure A

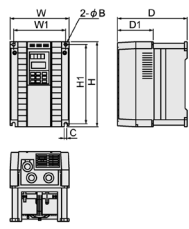

Figure B

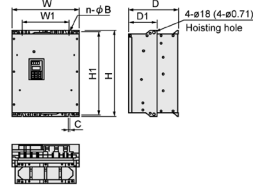

Figure C

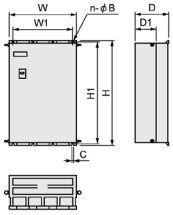
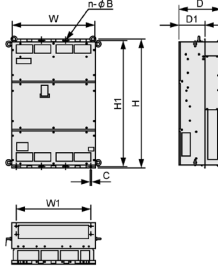

Figure D



PWM converter type	Figure	Dimensions								Mass kg (lb)	
		W	W1	H	H1	D	D1	n	B		C
RHC7.5-2C	A	250	226	380	358	245	125	2	10	10	12.5
RHC11-2C		(9.8)	(8.9)	(15.0)	(14.1)	(9.7)	(4.9)	(0.08)	(0.39)	(0.39)	(28)
RHC15-2C											
RHC18.5-2C	B	340	240	480	460	255	145	2	10	10	24
RHC22-2C		(13.4)	(9.5)	(18.9)	(18.1)	(10.0)	(5.7)	(0.08)	(0.39)	(0.39)	(53)
RHC30-2C	B	340	240	550	530	255	145	2	10	10	25
RHC37-2C		(13.4)	(9.5)	(21.7)	(20.9)	(10.0)	(5.7)	(0.08)	(0.39)	(0.39)	(64)
RHC45-2C	B	375	275	615	595	270	145	2	10	10	36
RHC55-2C		(14.8)	(10.8)	(24.2)	(23.4)	(10.6)	(5.7)	(0.08)	(0.39)	(0.39)	(79)
RHC75-2C	B	375	275	740	720	270	145	2	10	10	42
RHC90-2C		(14.8)	(10.8)	(29.1)	(28.4)	(10.6)	(5.7)	(0.08)	(0.39)	(0.39)	(93)
RHC110-2C	C	530	430	750	720	285	145	2	15	15	70
RHC132-2C		(20.9)	(16.9)	(29.5)	(28.4)	(11.2)	(5.7)	(0.08)	(0.59)	(0.59)	(154)
RHC160-2C	C	680	580	880	850	360	220	3	15	15	115
RHC200-2C		(26.8)	(22.8)	(34.7)	(33.5)	(14.2)	(8.7)	(0.12)	(0.59)	(0.59)	(254)
RHC220-2C	C	530	430	740	710	315	145	2	15	15	84
RHC280-2C		(20.9)	(16.9)	(29.1)	(28.0)	(12.4)	(5.7)	(0.08)	(0.59)	(0.59)	(188)
RHC315-2C	C	680	580	1000	970	360	220	3	15	15	140
RHC355-2C		(26.8)	(22.8)	(39.4)	(38.2)	(14.2)	(8.7)	(0.12)	(0.59)	(0.59)	(309)
RHC400-2C	C	680	580	1000	970	360	220	3	15	15	140
RHC450-2C		(26.8)	(22.8)	(39.4)	(38.2)	(14.2)	(8.7)	(0.12)	(0.59)	(0.59)	(309)
RHC500-2C	C	680	580	1400	1370	450	285	3	15	15	320
RHC630-2C		(26.8)	(22.8)	(55.1)	(53.9)	(17.7)	(11.2)	(0.12)	(0.59)	(0.59)	(705)
RHC7.5-4C	A	250	226	380	358	245	125	2	10	10	12.5
RHC11-4C		(9.8)	(8.9)	(15.0)	(14.1)	(9.7)	(4.9)	(0.08)	(0.39)	(0.39)	(28)
RHC15-4C											
RHC18.5-4C	B	340	240	480	460	255	145	2	10	10	24
RHC22-4C		(13.4)	(9.5)	(18.9)	(18.1)	(10.0)	(5.7)	(0.08)	(0.39)	(0.39)	(53)
RHC30-4C	B	340	240	550	530	255	145	2	10	10	29
RHC37-4C		(13.4)	(9.5)	(21.7)	(20.9)	(10.0)	(5.7)	(0.08)	(0.39)	(0.39)	(64)
RHC45-4C	B	375	275	550	530	270	145	2	10	10	34
RHC55-4C		(14.8)	(10.8)	(21.7)	(20.9)	(10.6)	(5.7)	(0.08)	(0.39)	(0.39)	(75)
RHC75-4C	B	375	275	675	655	270	145	2	10	10	38
RHC90-4C		(14.8)	(10.8)	(26.6)	(25.8)	(10.6)	(5.7)	(0.08)	(0.39)	(0.39)	(84)
RHC110-4C	B	375	275	740	720	270	145	2	10	10	48
RHC132-4C		(14.8)	(10.8)	(28.1)	(28.4)	(10.6)	(5.7)	(0.08)	(0.39)	(0.39)	(108)
RHC160-4C	C	530	430	740	710	315	145	2	15	15	70
RHC200-4C		(20.9)	(16.9)	(29.1)	(28.0)	(12.4)	(5.7)	(0.08)	(0.59)	(0.59)	(154)
RHC220-4C	C	530	430	1000	970	360	220	2	15	15	100
RHC280-4C		(20.9)	(16.9)	(39.4)	(38.2)	(14.2)	(8.7)	(0.08)	(0.59)	(0.59)	(220)
RHC315-4C	C	680	580	1000	970	360	220	3	15	15	140
RHC355-4C		(26.8)	(22.8)	(39.4)	(38.2)	(14.2)	(8.7)	(0.12)	(0.59)	(0.59)	(309)
RHC400-4C	C	680	580	1400	1370	450	285	3	15	15	320
RHC450-4C		(26.8)	(22.8)	(55.1)	(53.9)	(17.7)	(11.2)	(0.12)	(0.59)	(0.59)	(705)
RHC500-4C	C	880	780	1400	1370	450	285	4	15	15	410
RHC630-4C		(34.7)	(30.7)	(55.1)	(53.9)	(17.7)	(11.2)	(0.16)	(0.59)	(0.59)	(904)
RHC7.5-4C	D	999	900	1550	1520	500	313.2	4	15	15	525
RHC11-4C		(39.3)	(35.4)	(61.0)	(59.8)	(19.7)	(12.3)	(0.16)	(0.59)	(0.59)	(1157)

Boosting reactor

Figure A

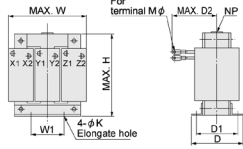

Figure B

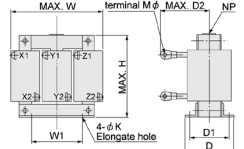

Figure C

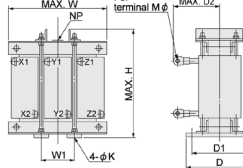
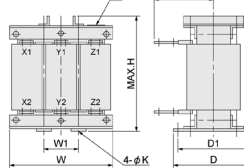
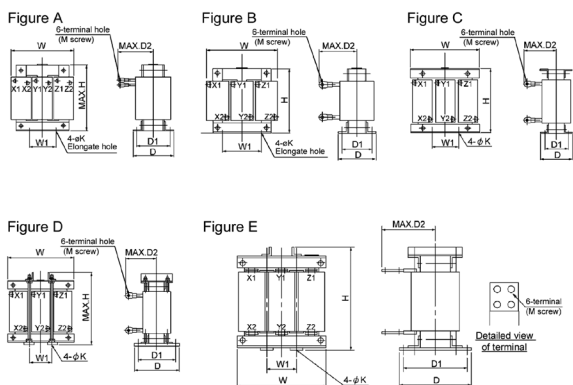

Figure D



Boosting reactor type	Figure	Dimensions								Mass kg (lb)
		W	W1	H	D	D1	D2	K	M	
LR2-7.5C	A	180	75	205	105	85	95	7	7	12
LR2-15C		(7.1)	(3.0)	(8.1)	(4.1)	(3.4)	(3.7)	(0.28)	(0.28)	(26)
LR2-22C										
LR2-37C	C	240	80	340	215	180	145	10	10	33
LR2-55C		(9.5)	(3.2)	(13.4)	(8.5)	(7.1)	(5.7)	(0.39)	(0.39)	(73)
LR2-75C	C	285	95	420	240	205	150	12	12	50
LR2-110C		(11.2)	(3.7)	(16.5)	(9.5)	(8.1)	(5.9)	(0.47)	(0.47)	(110)
LR2-150C	C	285	95	420	250	215	160	12	12	58
LR2-220C		(11.2)	(3.7)	(16.5)	(9.8)	(8.5)	(6.3)	(0.47)	(0.47)	(128)
LR2-315C	C	330	110	440	255	220	150	12	12	70
LR2-400C		(13.0)	(4.3)	(17.3)	(10.0)	(8.7)	(6.5)	(0.47)	(0.47)	(154)
LR2-500C	C	345	115	500	280	245	185	12	12	100
LR2-630C		(13.6)	(4.5)	(19.7)	(11.0)	(9.7)	(7.3)	(0.47)	(0.47)	(220)
LR4-7.5C	B	180	75	205	105	85	90	7	7	12
LR4-15C		(7.1)	(3.0)	(8.1)	(4.1)	(3.4)	(3.5)	(0.28)	(0.28)	(26)
LR4-22C										
LR4-37C	C	240	80	340	215	180	120	10	10	33
LR4-55C		(9.5)	(3.2)	(13.4)	(8.5)	(7.1)	(4.7)	(0.39)	(0.39)	(73)
LR4-75C	C	285	95	405	240	205	130	12	12	50
LR4-110C		(11.2)	(3.7)	(15.9)	(9.5)	(8.1)	(5.1)	(0.47)	(0.47)	(110)
LR4-150C	C	285	95	415	250	215	145	12	12	58
LR4-220C		(11.2)	(3.7)	(16.3)	(9.8)	(8.5)	(5.7)	(0.47)	(0.47)	(128)
LR4-315C	C	330	110	440	255	220	150	12	12	70
LR4-400C		(13.0)	(4.3)	(17.3)	(10.0)	(8.7)	(6.5)	(0.47)	(0.47)	(154)
LR4-500C	C	345	115	490	280	245	170	12	12	100
LR4-630C		(13.6)	(4.5)	(19.3)	(11.0)	(9.7)	(6.7)	(0.47)	(0.47)	(220)
LR4-750C	C	380	125	550	300	260	185	15	15	140
LR4-900C		(15.0)	(4.9)	(21.7)	(11.8)	(10.2)	(7.3)	(0.59)	(0.59)	(309)
LR4-1100C	C	450	150	620	330	290	230	15	15	200
LR4-1300C		(17.7)	(5.9)	(24.4)	(13.0)	(11.4)	(9.1)	(0.59)	(0.59)	(441)
LR4-1500C	C	480	160	740	330	290	240	15	15	250
LR4-1800C		(18.9)	(6.3)	(29.1)	(13.0)	(11.4)	(9.5)	(0.59)	(0.59)	(551)
LR4-2100C	C	480	160	760	340	300	250	15	15	270
LR4-2400C		(18.9)	(6.3)	(29.9)	(13.4)	(11.8)	(9.8)	(0.59)	(0.59)	(595)
LR4-2700C	C	480	160	830	355	315	255	15	15	310
LR4-3000C		(18.9)	(6.3)	(32.7)	(14.0)	(12.4)	(10.0)	(0.59)	(0.59)	(683)
LR4-3300C	C	480	160	890	380	330	260	19	19	340
LR4-3600C		(18.9)	(6.3)	(35.0)	(15.0)	(13.0)	(10.2)	(0.75)	(0.75)	(750)
LR4-3900C	C	525	175	960	410	360	290	19	19	420
LR4-4200C		(20.7)	(6.9)	(37.8)	(16.1)	(14.2)	(11.4)	(0.75)	(0.75)	(926)
LR4-4500C	D	600	200	640	440	390	285	15	15	450
LR4-5000C		(23.6)	(7.9)	(25.2)	(17.3)	(15.4)	(11.2)	(0.75)	(0.75)	(992)

Filtering reactor



Filtering reactor type	Figure	Dimensions							mm (inch)		Mass kg (lb)
		W	W1	H	D	D1	D2	K	M		
200 V series	LFC2-7.5C	B	125 (4.9)	40 (1.6)	100 (3.9)	85 (3.4)	67 (2.6)	85 (3.4)	6	M5	2.2 (4.9)
	LFC2-15C	B	125 (4.9)	40 (1.6)	100 (3.9)	93 (3.7)	75 (3.0)	90 (3.5)	6	M8	2.5 (5.5)
	LFC2-22C	B	125 (4.9)	40 (1.6)	100 (3.9)	93 (3.7)	75 (3.0)	105 (4.1)	6	M8	3.0 (6.6)
	LFC2-37C	B	150 (5.9)	60 (2.4)	115 (4.5)	103 (4.1)	85 (3.4)	125 (4.9)	6	M10	5.0 (11)
	LFC2-55C	B	175 (6.9)	60 (2.4)	145 (5.7)	110 (4.3)	90 (3.5)	140 (5.5)	6	M12	8.0 (18)
	LFC2-75C	B	195 (7.7)	80 (3.2)	200 (7.9)	120 (4.7)	100 (3.9)	150 (5.9)	7	M12	13 (29)
	LFC2-110C	C	255 (10.0)	85 (3.4)	230 (9.1)	118 (4.7)	95 (3.7)	165 (6.5)	7	M12	20 (44)
	LFC4-7.5C	A	125 (4.9)	40 (1.6)	100 (3.9)	85 (3.4)	67 (2.6)	75 (3.0)	6	M4	2.2 (4.9)
	LFC4-15C	A	125 (4.9)	40 (1.6)	100 (3.9)	93 (3.7)	75 (3.0)	90 (3.5)	6	M5	2.5 (5.5)
	LFC4-22C	A	125 (4.9)	40 (1.6)	100 (3.9)	93 (3.7)	75 (3.0)	95 (3.7)	6	M6	3.0 (6.6)
400 V series	LFC4-37C	B	150 (5.9)	60 (2.4)	115 (4.5)	103 (4.1)	85 (3.5)	125 (4.9)	6	M8	5.0 (11)
	LFC4-55C	B	175 (6.9)	60 (2.4)	145 (5.7)	110 (4.3)	90 (3.5)	120 (4.7)	6	M10	8.0 (18)
	LFC4-75C	B	195 (7.7)	80 (3.2)	200 (7.9)	120 (4.7)	100 (3.9)	150 (5.9)	7	M10	13 (29)
	LFC4-110C	C	255 (10.0)	85 (3.4)	220 (8.7)	113 (4.5)	90 (3.5)	145 (5.7)	7	M12	19 (42)
	LFC4-160C	C	255 (10.0)	85 (3.4)	245 (9.7)	137 (5.4)	110 (4.3)	160 (6.3)	10	M12	22 (49)
	LFC4-220C	D	300 (11.8)	100 (3.9)	320 (12.6)	210 (8.3)	180 (7.1)	170 (6.7)	10	M12	35 (77)
	LFC4-280C	D	330 (13.0)	110 (4.3)	330 (13.0)	230 (9.1)	195 (7.7)	195 (7.7)	12	M16	43 (95)
	LFC4-315C	D	315 (12.4)	105 (4.1)	365 (14.4)	230 (9.1)	195 (7.7)	200 (7.9)	12	M16	48 (106)
	LFC4-355C	D	315 (12.4)	105 (4.1)	395 (15.6)	235 (9.3)	200 (7.9)	210 (8.3)	12	M16	53 (117)
	LFC4-400C	D	345 (13.6)	115 (4.5)	420 (16.5)	235 (9.3)	200 (7.9)	235 (9.3)	12	M16	60 (132)
LFC4-500C	D	345 (13.6)	115 (4.5)	480 (18.9)	240 (9.5)	205 (8.1)	240 (9.5)	12	M16	72 (159)	
LFC4-630C	E	435 (17.1)	145 (5.7)	550 (21.7)	285 (11.6)	255 (10.0)	200 (7.9)	15 (0.59)	—	175 (386)	

Filtering capacitor

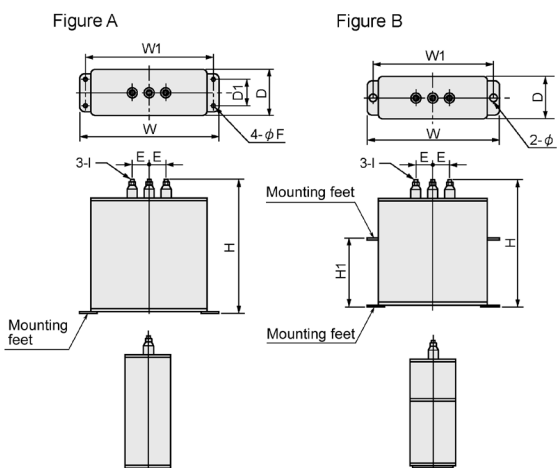

Filtering capacitor type	Figure	Dimensions							mm (inch)		Mass kg (lb)	
		W	W1	H	H1	D	D1	E	F	I		
200 V series	CF2-7.5C	A	165 (6.5)	150 (5.9)	185 (7.3)	—	70 (2.8)	40 (1.6)	30 (1.2)	7 (0.28)	M5	1.9 (4.2)
	CF2-15C	A	205 (8.1)	173 (6.8)	245 (9.7)	—	70 (2.8)	40 (1.6)	30 (1.2)	7 (0.28)	M5	3.5 (7.7)
	CF2-22C	A	280 (11.0)	265 (10.4)	260 (10.2)	—	90 (3.5)	55 (2.2)	80 (3.2)	7 (0.28)	M5	6.0 (13.0)
	CF2-37C	A	280 (11.0)	265 (10.4)	290 (11.4)	—	90 (3.5)	55 (2.2)	80 (3.2)	7 (0.28)	M5	7.0 (15.0)
	CF2-55C	A	280 (11.0)	265 (10.4)	340 (13.4)	—	90 (3.5)	55 (2.2)	80 (3.2)	7 (0.28)	M8	8.5 (19.0)
	CF2-75C	A	280 (11.0)	265 (10.4)	290 (11.4)	—	90 (3.5)	55 (2.2)	80 (3.2)	7 (0.28)	M8	7.0 (15.0)
400 V series	CF2-110C	A	280 (11.0)	265 (10.4)	340 (13.4)	—	90 (3.5)	55 (2.2)	80 (3.2)	7 (0.28)	M8	8.5 (19.0)
	CF4-7.5C	A	165 (6.5)	150 (5.9)	135 (5.3)	—	70 (2.8)	40 (1.6)	30 (1.2)	7 (0.28)	M5	1.3 (2.9)
	CF4-15C	A	165 (6.5)	150 (5.9)	215 (8.5)	—	70 (2.8)	40 (1.6)	30 (1.2)	7 (0.28)	M5	2.3 (5.1)
	CF4-22C	A	205 (8.1)	173 (6.8)	245 (9.7)	—	70 (2.8)	40 (1.6)	30 (1.2)	7 (0.28)	M5	2.5 (5.5)
	CF4-37C	A	205 (8.1)	190 (7.5)	205 (8.1)	—	70 (2.8)	40 (1.6)	30 (1.2)	7 (0.28)	M5	2.9 (6.4)
	CF4-55C	A	205 (8.1)	190 (7.5)	245 (9.7)	—	70 (2.8)	40 (1.6)	30 (1.2)	7 (0.28)	M5	3.5 (7.7)
	CF4-75C	A	205 (8.1)	190 (7.5)	205 (8.1)	—	70 (2.8)	40 (1.6)	30 (1.2)	7 (0.28)	M5	2.9 (6.4)
	CF4-110C	A	205 (8.1)	190 (7.5)	245 (9.7)	—	70 (2.8)	40 (1.6)	30 (1.2)	7 (0.28)	M5	3.5 (7.7)
	CF4-160C	A	280 (11.0)	265 (10.4)	260 (10.2)	—	90 (3.5)	55 (2.2)	80 (3.2)	7 (0.28)	M6	6.0 (13.0)
	CF4-220C	B	435 (17.1)	400 (15.8)	310 (12.2)	125 (4.9)	100 (3.9)	—	80 (3.2)	15 × 20 * (0.59 × 0.79)	M12	13.0 (29.0)
	CF4-280C	B	435 (17.1)	400 (15.8)	350 (13.8)	165 (6.5)	100 (3.9)	—	80 (3.2)	15 × 20 * (0.59 × 0.79)	M12	15.0 (33.0)
	CF4-315C	B	435 (17.1)	400 (15.8)	460 (18.1)	275 (10.8)	100 (3.9)	—	80 (3.2)	15 × 20 * (0.59 × 0.79)	M12	20.0 (44.0)
	CF4-355C	B	435 (17.1)	400 (15.8)	520 (20.5)	335 (13.2)	100 (3.9)	—	80 (3.2)	15 × 20 * (0.59 × 0.79)	M12	23.0 (51.0)
	CF4-400C	B	435 (17.1)	400 (15.8)	610 (24.0)	425 (16.7)	100 (3.9)	—	80 (3.2)	15 × 20 * (0.59 × 0.79)	M12	27.0 (60)
CF4-500C	B	435 (17.1)	400 (15.8)	310 (12.2)	125 (4.9)	100 (3.9)	—	80 (3.2)	15 × 20 * (0.59 × 0.79)	M12	13.0 (29.0)	
CF4-630C	B	435 (17.1)	400 (15.8)	460 (18.1)	275 (10.8)	100 (3.9)	—	80 (3.2)	15 × 20 * (0.59 × 0.79)	M12	20.0 (44.0)	

* Elongate hole



- Mount vertically. Do not lower onto its side and mount.
- All mounting feet must be secured to the cabinet floor, etc. Figure A: 2 mounting feet locations, Figure B: 4 mounting feet locations

Damage may occur due to vibrations or impact.

Filtering resistor

Figure A

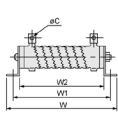

Figure B

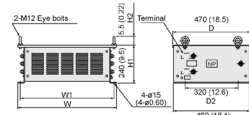
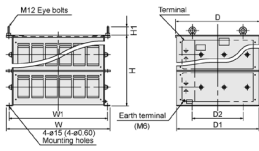

Figure C



Filtering resistor type	Figure	Dimensions										Mass kg (lb)	Q'ty
		W	W1	W2	H1	H2	D	D1	D2	C	mm (inch)		
200 V series	GRZG80 0.42Ω	A	167 (6.6)	148 (5.9)	115 (4.5)	22 (0.87)	32 (1.3)	33 (1.3)	26 (1.0)	6 (0.24)	5.5 (0.22)	0.19 (0.4)	3
	GRZG150 0.2Ω	A	247 (9.7)	228 (9.0)	195 (7.7)	22 (0.87)	32 (1.3)	33 (1.3)	26 (1.0)	6 (0.24)	5.5 (0.22)	0.19 (0.4)	3
	GRZG200 0.13Ω	A	306 (12.1)	287 (11.3)	254 (10.0)	22 (0.87)	32 (1.3)	33 (1.3)	26 (1.0)	6 (0.24)	5.5 (0.22)	0.35 (0.8)	3
	GRZG400 0.1Ω	A	411 (16.2)	385 (15.2)	330 (13.0)	40 (1.6)	39 (1.5)	47 (1.9)	40 (1.6)	9.5 (0.37)	5.5 (0.22)	0.85 (1.9)	3
	GRZG400 0.12Ω	A	411 (16.2)	385 (15.2)	330 (13.0)	40 (1.6)	39 (1.5)	47 (1.9)	40 (1.6)	9.5 (0.37)	5.5 (0.22)	0.85 (1.9)	3
400 V series	GRZG80 1.74Ω	A	167 (6.6)	148 (5.8)	115 (4.5)	22 (0.87)	32 (1.3)	33 (1.3)	26 (1.0)	6 (0.24)	5.5 (0.22)	0.19 (0.4)	3
	GRZG150 0.79Ω	A	247 (9.7)	228 (9.0)	195 (7.7)	22 (0.87)	32 (1.3)	33 (1.3)	26 (1.0)	6 (0.24)	5.5 (0.22)	0.19 (0.4)	3
	GRZG200 0.53Ω	A	306 (12.1)	287 (11.3)	254 (10.0)	22 (0.87)	32 (1.3)	33 (1.3)	26 (1.0)	6 (0.24)	5.5 (0.22)	0.35 (0.8)	3
	GRZG400 0.38Ω	A	411 (16.2)	385 (15.2)	330 (13.0)	40 (1.6)	39 (1.5)	47 (1.9)	40 (1.6)	9.5 (0.37)	5.5 (0.22)	0.85 (1.9)	3
	GRZG400 0.26Ω	A	411 (16.2)	385 (15.2)	330 (13.0)	40 (1.6)	39 (1.5)	47 (1.9)	40 (1.6)	9.5 (0.37)	5.5 (0.22)	0.85 (1.9)	3
	GRZG400 0.53Ω	A	411 (16.2)	385 (15.2)	330 (13.0)	40 (1.6)	39 (1.5)	47 (1.9)	40 (1.6)	9.5 (0.37)	5.5 (0.22)	0.85 (1.9)	6
	RF4-160C	B	400 (15.8)	370 (14.6)	—	240 (9.5)	55 (2.2)	470 (18.5)	460 (18.1)	320 (12.6)	—	22 (49)	1
	RF4-220C										25 (55)	1	
	RF4-280C	C	655 (25.8)	625 (24.6)	—	240 (9.5)	55 (2.2)	470 (18.5)	460 (18.1)	320 (12.6)	—	31 (68.3)	1
	RF4-315C										35 (77.2)	1	
	RF4-355C										36 (79.4)	1	
	RF4-400C										38 (83.8)	1	
	RF4-500C										41 (90)	1	
RF4-630C	C	655 (25.8)	625 (24.6)	—	440 (17.3)	55 (2.2)	530 (20.9)	520 (20.5)	320 (12.6)	—	70 (154)	1	

Charging box

The charging box contains a combination of a charging resistor and a fuse, which is essential in the configuration of the RHC-C series of PWM converters. Using this charging box eases mounting and wiring jobs.

■ **Capacity range**

200 V class series: 7.5 to 90 kW (10 to 150 HP) in 10 types,

400 V class series: 7.5 to 220 kW (10 to 450 HP) in 14 types, Total 24 types

As for 400 V class series with a capacity of 280 to 400 kW (500 to 800 HP), the charging resistor and the fuse are separately provided as before.

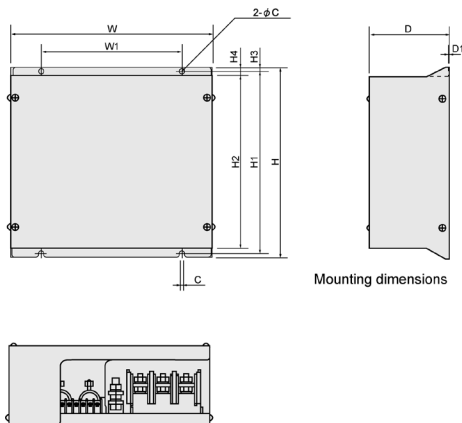

Fuse type	Dimensions										Mounting bolt	Mass kg (lb)	
	W	W1	H	H1	H2	H3	H4	D	D1	C			mm (inch)
230 V series	CU7.5-2C	270	170	300	285	270	7.5	15	100	2.4	6	M5	6
	CU11-2C	(10.6)	(6.7)	(11.8)	(11.2)	(10.6)	(0.3)	(0.59)	(3.9)	(0.09)	(0.24)		(13)
	CU15-2C												7
	CU18.5-2C												(15)
	CU22-2C												8
	CU30-2C	300	200	310	295	280				110	4.3		(17.6)
	CU45-2C	330	230							130	5.1		17
	CU55-2C	430	330	560	536	510	12	25	150	3.2	10	M8	(37.5)
460 V series	CU90-2C	(16.9)	(13.0)	(22.1)	(21.1)	(20.1)	(0.47)	(0.98)	(5.9)	(0.13)	(0.39)		20
													(44.1)
	CU7.5-4C	270	170	300	285	270	7.5	15	100	2.4	6	M5	5.5
	CU11-4C	(10.6)	(6.7)	(11.8)	(11.2)	(10.6)	(0.3)	(0.59)	(3.9)	(0.09)	(0.24)		(12.1)
	CU15-4C												6
	CU18.5-4C												(13)
	CU22-4C												7
	CU30-4C	300	200	310	295	280				110	4.3		(15)
	CU45-4C	330	230							130	5.1		8
	CU55-4C	430	330	560	536	510	12	25	150	3.2	10	M8	(17.6)
CU75-4C	(16.9)	(13.0)	(22.1)	(21.1)	(20.1)	(0.47)	(0.98)	(5.9)	(0.13)	(0.39)		18	
CU90-4C												(40)	
CU110-4C												20	
CU132-4C												(44.1)	
CU160-4C													
CU200-4C													
CU220-4C													

Charging resistor

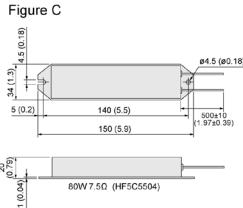
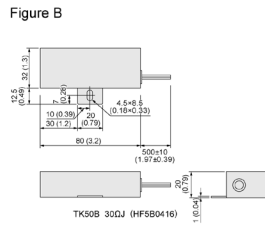
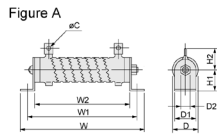

Charging resistor type	Figure	Dimensions										Mass g (lb)
		W	W1	W2	H1	H2	D	D1	D2	C		
GRZG120 2Ω	A	217 (8.5)	198 (7.8)	165 (6.5)	22 (0.87)	32 (1.3)	33 (1.3)	26 (1.0)	6 (0.24)	5.5 (0.22)	250 (0.6)	
GRZG400 1Ω	A	411 (16.2)	385 (15.2)	330 (13.0)	40 (1.6)	39 (1.5)	47 (1.9)	40 (1.6)	9.5 (0.37)	850 (1.9)		
TK50B 30ΩJ (HF5B0416)	B	—	—	—	—	—	—	—	—	150 (0.3)		
80W 7.5Ω (HF5C5504)	C	—	—	—	—	—	—	—	—	—		

Fuse

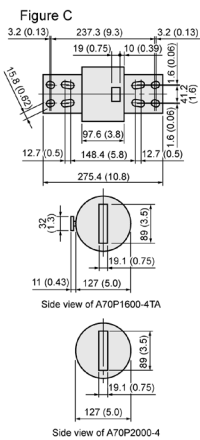
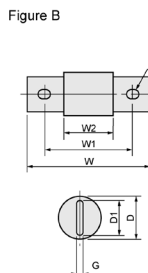
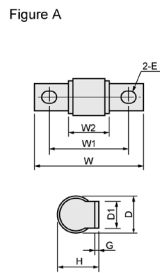

Fuse type	Figure	Dimensions							Mass g (lb)		
		W	W1	W2	H	D	D1	G			
230 V series	A	CR2LS-50/U/L	56 (2.2)	42 (1.7)	26 (1.0)	18.5 (0.73)	17.5 (0.69)	12 (0.47)	2 (0.08)	6.5×8.5 (0.26×0.33)	28 (0.1)
		CR2LS-75/U/L	—	—	—	—	—	—	—	—	—
		CR2LS-100/U/L	—	—	—	—	—	—	—	—	—
	A	CR2L-150/U/L	80 (3.2)	58 (2.3)	29.5 (1.2)	30.5 (1.2)	27 (1.1)	20 (0.79)	3 (0.12)	9×11 (0.35×0.43)	100 (0.2)
		CR2L-200/U/L	85 (3.4)	60 (2.4)	30 (1.2)	33.5 (1.3)	30 (1.2)	25 (0.98)	3.2 (0.13)	11×13 (0.43×0.51)	130 (0.3)
		CR2L-260/U/L	—	—	—	—	—	—	—	—	—
460 V series	A	CR6L-30/U/L	78 (3.0)	62 (2.4)	47 (1.9)	18.5 (0.73)	17.5 (0.69)	12 (0.47)	2 (0.08)	6.5×8.5 (0.26×0.33)	42 (0.1)
		CR6L-50/U/L	—	—	—	—	—	—	—	—	—
		CR6L-75/U/L	—	—	—	—	—	—	—	—	—
	A	CR6L-100/U/L	95 (3.7)	70 (2.8)	40 (1.6)	34 (1.3)	30 (1.2)	25 (0.98)	3.2 (0.13)	11×13 (0.43×0.51)	150 (0.3)
		CR6L-150/U/L	—	—	—	—	—	—	—	—	—
		CR6L-200/U/L	—	—	—	—	—	—	—	—	—
	B	CR6L-300/U/L	107 (4.2)	82 (3.2)	43 (1.7)	42 (1.7)	37 (1.5)	30 (1.2)	4 (0.16)	11×13 (0.43×0.51)	246 (0.5)
		A50P400-4	110 (4.3)	78.6 (3.1)	53.1 (2.1)	—	38.1 (1.5)	25.4 (1.0)	6.4 (0.25)	10.3×18.4 (0.41×0.72)	290 (0.6)
		A50P600-4	113.5 (4.5)	81.75 (3.2)	56.4 (2.2)	—	50.8 (2.0)	38.1 (1.5)	6.4 (0.25)	10.3×18.4 (0.41×0.72)	540 (1.2)
		A70QS800-4	180.2 (7.1)	128.4 (5.1)	72.2 (2.8)	—	83.5 (2.5)	50.8 (2.0)	9.5 (0.37)	13.5×18.3 (0.53×0.72)	1080 (2.4)
		A70P1600-4TA	—	—	—	—	—	—	—	—	7400 (16.3)
		A70P2000-4	—	—	—	—	—	—	—	—	8000 (17.6)

■ Generated loss

In CT mode

PWM converter		Boosting reactor		Filtering reactor		Filtering resistor		
Type	Generated loss (W)	Type	Generated loss (W)	Type	Generated loss (W)	Type	Q'ty	Generated loss (W)
RHC7.5-2C	400	LR2-7.5C	95	LFC2-7.5C	10	GRZG80 0.42Ω	3	16
RHC11-2C	500	LR2-15C	150	LFC2-15C	19	GRZG150 0.2Ω	3	48
RHC15-2C	650							
RHC18.5-2C	700	LR2-22C	230	LFC2-22C	26	GRZG200 0.13Ω	3	68
RHC22-2C	800							
RHC30-2C	1000	LR2-37C	330	LFC2-37C	32	GRZG400 0.1Ω	3	107
RHC37-2C	1350							
RHC45-2C	1500							
RHC55-2C	1750							
RHC75-2C	2050	LR2-75C	520	LFC2-75C	74	GRZG400 0.12Ω <small>Two in parallel</small>	6	137
RHC90-2C	2450	LR2-110C	720	LR2-110C	115			374
RHC7.5-4C	400	LR4-7.5C	90	LFC4-7.5C	9			GRZG80 1.74Ω
RHC11-4C	500	LR4-15C	160	LFC4-15C	20	GRZG150 0.79Ω	3	48
RHC15-4C	600							
RHC18.5-4C	650	LR4-22C	230	LFC4-22C	22	GRZG200 0.53Ω	3	70
RHC22-4C	900							
RHC30-4C	1200	LR4-37C	350	LFC4-37C	36	GRZG400 0.38Ω	3	86
RHC37-4C	1550							
RHC45-4C	1800							
RHC55-4C	2050							
RHC75-4C	2150	LR4-75C	520	LFC4-75C	78	GRZG400 0.38Ω	3	112
RHC90-4C	2600	LR4-110C	710	LFC4-110C	90	GRZG400 0.53Ω <small>Two in parallel</small>	6	405
RHC110-4C	3050							
RHC132-4C	3500	LR4-160C	1000	LFC4-160C	160	RF4-160C	1	568
RHC160-4C	4150							
RHC200-4C	5100	LR4-220C	1240	LFC4-220C	200	RF4-220C	1	751
RHC220-4C	5600							
RHC280-4C	7100	LR4-280C	1430	LFC4-280C	220	RF4-280C	1	1027
RHC315-4C	8000	LR4-315C	1660	LFC4-315C	260	RF4-315C	1	1154
RHC355-4C	8900	LR4-355C	1910	LFC4-355C	300	RF4-355C	1	1286
RHC400-4C	10100	LR4-400C	2160	LFC4-400C	350	RF4-400C	1	1454

In VT mode

PWM converter		Boosting reactor		Filtering reactor		Filtering resistor		
Type	Generated loss (W)	Type	Generated loss (W)	Type	Generated loss (W)	Type	Q'ty	Generated loss (W)
RHC7.5-2C	450	LR2-15C	150	LFC2-15C	19	GRZG150 0.2Ω	3	48
RHC11-2C	550							
RHC15-2C	650	LR2-22C	230	LFC2-22C	26	GRZG200 0.13Ω	3	68
RHC18.5-2C	750							
RHC22-2C	850	LR2-37C	330	LFC2-37C	32	GRZG400 0.1Ω	3	107
RHC30-2C	1200							
RHC37-2C	1500							
RHC45-2C	1600							
RHC55-2C	2100	LR2-75C	520	LFC2-75C	74	GRZG400 0.12Ω <small>(2 parts in parallel)</small>	6	137
RHC75-2C	2300	LR2-110C	720	LFC2-110C	115			374
RHC90-2C	2650	LR4-15C	160	LFC4-15C	20			GRZG150 0.79Ω
RHC7.5-4C	400							
RHC11-4C	500	LR4-22C	230	LFC4-22C	22	GRZG200 0.53Ω	3	70
RHC15-4C	600							
RHC18.5-4C	600	LR4-37C	350	LFC4-37C	36	GRZG400 0.38Ω	3	86
RHC22-4C	950							
RHC30-4C	1200							
RHC37-4C	1450							
RHC45-4C	1750	LR4-55C	490	LFC4-55C	43	GRZG400 0.26Ω	3	130
RHC55-4C	2250							
RHC75-4C	1950	LR4-110C	710	LFC4-110C	90	GRZG400 0.53Ω <small>(2 parts in parallel)</small>	6	405
RHC90-4C	2400							
RHC110-4C	2900	LR4-160C	1000	LFC4-160C	160	RF4-160C	1	568
RHC132-4C	3250							
RHC160-4C	4100	LR4-220C	1240	LFC4-220C	200	RF4-220C	1	751
RHC200-4C	4400							
RHC220-4C	5600	LR4-280C	1430	LFC4-280C	220	RF4-280C	1	1027
RHC280-4C	6250	LR4-315C	1660	LFC4-315C	260	RF4-315C	1	1154
RHC315-4C	7000	LR4-355C	1910	LFC4-355C	300	RF4-355C	1	1286
RHC355-4C	8050	LR4-400C	2160	LFC4-400C	350	RF4-400C	1	1454
RHC400-4C	8950	LR4-500C	2470	LFC4-500C	450	RF4-500C	1	1821

Note: Generated losses listed in the above tables are approximate values that are calculated according to the following conditions:

- The power supply is three-phase 200 V/400 V 50 Hz with 0% interphase voltage unbalance ratio.
- The capacity of the power supply used is the larger of either 500 kVA or 10 times the rated capacity of the inverter.
- The motor is a 4-pole standard model at full load (100%).

11.10 DC Reactors (DCRs)

A DCR is mainly used for power supply matching and for input power factor correction (for reducing harmonic components).

■ For power supply matching

- Use a DCR when the capacity of a power supply transformer exceeds 500 kVA and is 10 times or more the rated inverter capacity. In this case, the percent reactance of the power supply decreases, and harmonic components and their peak value increase. These factors may break rectifiers or capacitors in the converter section of inverter, or decrease the capacitance of the capacitor (which can shorten the inverter's service life).
- Also use a DCR when there are thyristor-driven loads or when phase-advancing capacitors are being turned ON/OFF.
- Use a DCR when the interphase voltage unbalance ratio of the inverter power supply exceeds 2%.

$$\text{Interphase voltage unbalance (\%)} = \frac{\text{Max. voltage (V)} - \text{Min. voltage (V)}}{\text{Three - phase average voltage (V)}} \times 67$$

■ For input power factor correction (for suppressing harmonics)

Generally a capacitor is used to improve the power factor of the load, however, it cannot be used in a system that includes an inverter. Using a DCR increases the reactance of inverter's power supply so as to decrease harmonic components on the power supply lines and improve the power factor of inverter. Using a DCR improves the input power factor to approximately 86% to 95%.



Note

- At the time of shipping, a jumper bar is connected across terminals P1 and P (+) on the terminal block. Remove the jumper bar when connecting a DCR.
- If a DCR is not going to be used, do not remove the jumper bar.
- Please select in the capacity of the applicable motor selection of DC reactor.

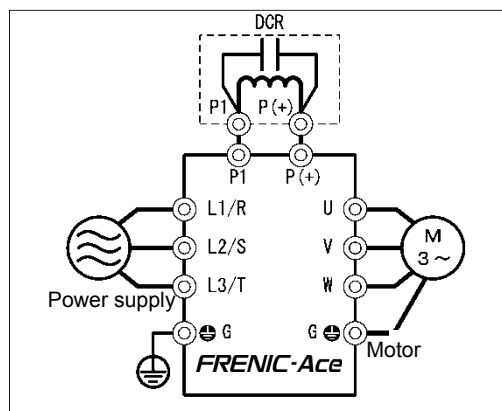
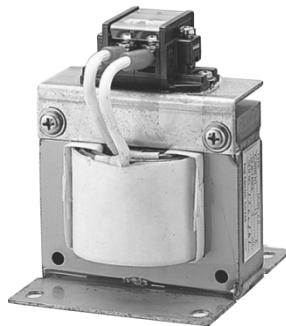

Figure 11.10-1 External View of a DC Reactor (DCR) and Connection Example

Table 11.10-1 DC Reactors (DCRs)

Power supply voltage	Nominal applied motor (kW)	Nominal applied motor (HP)	DC reactor type	Rated current (A)	Inductance (mH)	Generated loss (W)
Three-phase 200V	0.1	1/8	DCR2-0.2	1.5	20	0.8
	0.2	1/4				1.6
	0.4	1/2	DCR2-0.4	3.0	12	1.9
	0.75	1	DCR2-0.75	5.0	7.0	2.8
	1.5	2	DCR2-1.5	8.0	4.0	4.6
	2.2	3	DCR2-2.2	11	3.0	6.7
	3.0	4	DCR2-3.7	18	1.7	8.8
	3.7	5				
	5.5	7.5	DCR2-5.5	25	1.2	14
	7.5	10	DCR2-7.5	34	0.8	16
	11	15	DCR2-11	50	0.6	27
	15	20	DCR2-15	67	0.4	27
	18.5	25	DCR2-18.5	81	0.35	29
22	30	DCR2-22A	98	0.3	38	
30	40	DCR2-30B	136	0.23	37	
Three-phase 400V	0.4	1/2	DCR4-0.4	1.5	50	2.0
	0.75	1	DCR4-0.75	2.5	30	2.5
	1.1	1 1/2	DCR4-1.5	4.0	16	4.8
	1.5	2				
	2.2	3	DCR4-2.2	5.5	12	6.8
	3.0	4	DCR4-3.7	9.0	7.0	8.1
	3.7	5				
	5.5	7.5	DCR4-5.5	13	4	10
	7.5	10	DCR4-7.5	18	3.5	15
	11	15	DCR4-11	25	2.2	21
	15	20	DCR4-15	34	1.8	28
	18.5	25	DCR4-18.5	41	1.4	29
	22	30	DCR4-22A	49	1.2	35
	30	40	DCR4-30B	71	0.86	35
	37	50	DCR4-37B/DCR4-37C	88/88	0.70/0.483	40/63
	45	60	DCR4-45B/DCR4-45C	107/107	0.58/0.4	44/69
	55	75	DCR4-55B/DCR4-55C	131/131	0.47/0.324	55/78
	75	100	DCR4-75C	178	0.23	97
	90	125	DCR4-90C	214	0.2	111
	110	150	DCR4-110C	261	0.166	122
132	200	DCR4-132C	313	0.148	159	
160	250	DCR4-160C	380	0.122	185	
200	300	DCR4-200C	475	0.098	218	
220	350	DCR4-220C	524	0.087	231	
250	400	DCR4-250C	589	0.077	249	
280	450	DCR4-280C	649	0.069	270	
315	475	DCR4-315C	739	0.061	285	
355	500	DCR4-355C	833	0.054	308	
Single-phase 200V	0.1	1/8	DCR2-0.2	1.5	20	1.6
	0.2	1/4	DCR2-0.4	3.0	12	1.9
	0.4	1/2	DCR2-0.75	5.0	7.0	2.8
	0.75	1	DCR2-1.5	8.0	4.0	4.6
	1.5	2	DCR2-3.7	18	1.7	8.8
	2.2	3				
	3.0	4	DCR2-5.5	25	1.2	14

Note: Generated losses listed in the above tables are approximate values that are calculated according to the following conditions:

- The power supply is three-phase 200V/400 V 50 Hz with 0% interphase voltage unbalance ratio.
- The capacity of the power supply used is the larger of either 500 kVA or 10 times the rated capacity of the inverter.
- The motor is a 4-pole standard model at full load (100%).
- An AC reactor (ACR) is not connected.

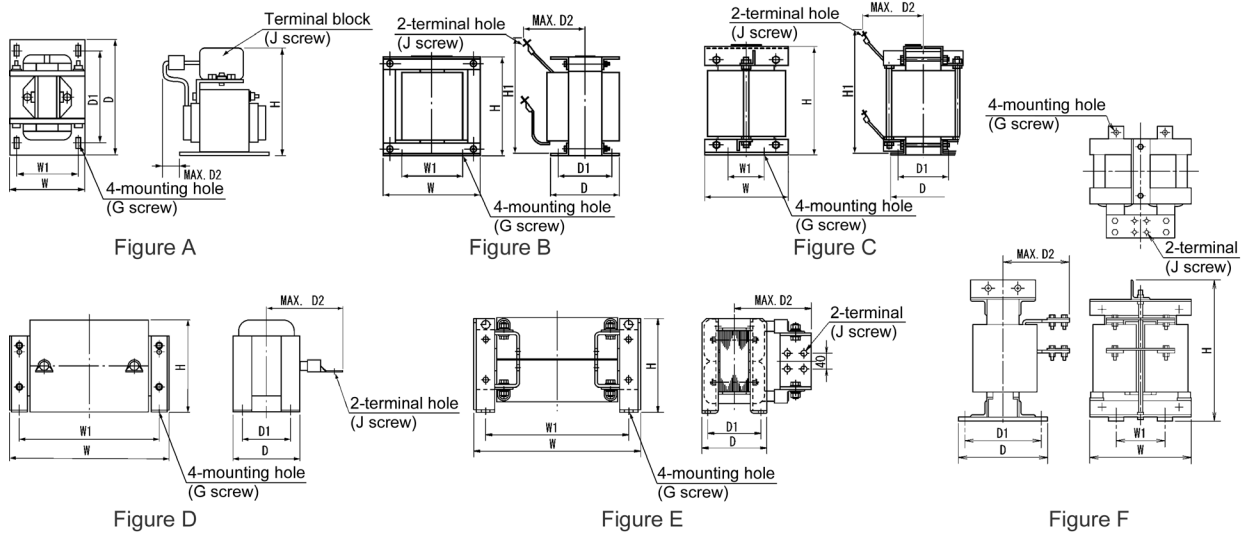

Table 11.10-2 DC Reactors (DCRs) External Dimensions

Power supply voltage	DC reactor type	Figure	Dimensions mm (inch)								Mounting hole	Terminal hole	Mass kg (lb)
			W	W1	D	D1	D2	H	H1				
Three-phase 200V	DCR2-0.2	A	66 (2.6)	56 (2.2)	90 (3.5)	72 (2.8)	5 (0.2)	94 (3.7)	—	M4 (5.2×8 (0.2×0.31))	M4	0.8 (1.8)	
	DCR2-0.4	A	66 (2.6)	56 (2.2)	90 (3.5)	72 (2.8)	15 (0.59)	94 (3.7)	—	M4 (5.2×8 (0.2×0.31))	M4	1.0 (2.2)	
	DCR2-0.75	A	66 (2.6)	56 (2.2)	90 (3.5)	72 (2.8)	20 (0.79)	94 (3.7)	—	M4 (5.2×8 (0.2×0.31))	M4	1.4 (3.1)	
	DCR2-1.5	A	66 (2.6)	56 (2.2)	90 (3.5)	72 (2.8)	20 (0.79)	94 (3.7)	—	M4 (5.2×8 (0.2×0.31))	M4	1.6 (3.5)	
	DCR2-2.2	A	86 (3.4)	71 (2.8)	100 (3.9)	80 (3.1)	10 (0.79)	110 (4.3)	—	M5 (6×9 (0.24×0.35))	M4	1.8 (4.0)	
	DCR2-3.7	A	86 (3.4)	71 (2.8)	100 (3.9)	80 (3.1)	20 (0.79)	110 (4.3)	—	M5 (6×9 (0.24×0.35))	M4	2.6 (5.7)	
	DCR2-5.5	A	111 (4.4)	95 (3.7)	100 (3.9)	80 (3.1)	20 (0.79)	130 (5.1)	—	M6 (7×11 (0.28×0.43))	M5	3.6 (7.9)	
	DCR2-7.5	A	111 (4.4)	95 (3.7)	100 (3.9)	80 (3.1)	23 (0.91)	130 (5.1)	—	M6 (7×11 (0.28×0.43))	M5	3.8 (8.4)	
	DCR2-11	A	111 (4.4)	95 (3.7)	100 (3.9)	80 (3.1)	24 (0.94)	137 (5.4)	—	M6 (7×11 (0.28×0.43))	M6	4.3 (9.5)	
	DCR2-15	A	146 (5.7)	124 (4.9)	120 (4.7)	96 (3.8)	15 (0.59)	180 (7.1)	—	M6 (7×11 (0.28×0.43))	M8	5.9 (13)	
	DCR2-18.5	A	146 (5.7)	124 (4.9)	120 (4.7)	96 (3.8)	25 (0.98)	180 (7.1)	—	M6 (7×11 (0.28×0.43))	M8	7.4 (16)	
	DCR2-22A	A	146 (5.7)	124 (4.9)	120 (4.7)	96 (3.8)	25 (0.98)	180 (7.1)	—	M6 (7×11 (0.28×0.43))	M8	7.5 (17)	

Table 11.10-3 DC Reactors (DCRs) External Dimensions (continue)

Power supply voltage	DC reactor type	Figure	Dimensions mm (inch)									Terminal hole	Mass kg (lb)
			W	W1	D	D1	D2	H	H1	Mounting hole			
Three-phase 400V	DCR4-0.4	A	66 (2.6)	56 (2.2)	90 (3.5)	72 (2.8)	15 (0.59)	94 (3.7)	—	M4 (5.2×8 (0.2×0.31))	M4	1.0 (2.2)	
	DCR4-0.75	A	66 (2.6)	56 (2.2)	90 (3.5)	72 (2.8)	20 (0.79)	94 (3.7)	—	M4 (5.2×8 (0.2×0.31))	M4	1.4 (3.1)	
	DCR4-1.5	A	66 (2.6)	56 (2.2)	90 (3.5)	72 (2.8)	20 (0.79)	94 (3.7)	—	M4 (5.2×8 (0.2×0.31))	M4	1.6 (3.5)	
	DCR4-2.2	A	86 (3.4)	71 (2.8)	100 (3.9)	80 (3.1)	15 (0.59)	110 (4.3)	—	M5 (6×9 (0.24×0.35))	M4	2.0 (4.4)	
	DCR4-3.7	A	86 (3.4)	71 (2.8)	100 (3.9)	80 (3.1)	20 (0.79)	110 (4.3)	—	M5 (6×9 (0.24×0.35))	M4	2.6 (5.7)	
	DCR4-5.5	A	86 (3.4)	71 (2.8)	100 (3.9)	80 (3.1)	20 (0.79)	110 (4.3)	—	M5 (6×9 (0.24×0.35))	M4	2.6 (5.7)	
	DCR4-7.5	A	111 (4.4)	95 (3.7)	100 (3.9)	80 (3.1)	24 (0.94)	130 (5.1)	—	M6 (7×11 (0.28×0.43))	M5	4.2 (9.3)	
	DCR4-11	A	111 (4.4)	95 (3.7)	100 (3.9)	80 (3.1)	24 (0.94)	130 (5.1)	—	M6 (7×11 (0.28×0.43))	M5	4.3 (9.5)	
	DCR4-15	A	146 (5.7)	124 (4.9)	120 (4.7)	96 (3.8)	15 (0.59)	168 (6.6)	—	M6 (7×11 (0.28×0.43))	M5	5.9 (13)	
	DCR4-18.5	A	146 (5.7)	124 (4.9)	120 (4.7)	96 (3.8)	25 (0.98)	171 (6.7)	—	M6 (7×11 (0.28×0.43))	M6	7.2 (16)	
	DCR4-22A	A	146 (5.7)	124 (4.9)	120 (4.7)	96 (3.8)	25 (0.98)	171 (6.7)	—	M6 (7×11 (0.28×0.43))	M6	7.2 (16)	
	DCR4-30B	B	152 (6.0)	90 (3.5)	157 (6.2)	115 (4.5)	100 (3.9)	130 (5.1)	190 (7.5)	M6 (ø8 (ø 0.31))	M8	13 (29)	
	DCR4-37B	B	171 (6.7)	110 (4.3)	150 (5.9)	110 (4.3)	100 (3.9)	150 (5.9)	200 (7.9)	M6 (ø8 (ø 0.31))	M8	15 (33)	
	DCR4-37C	D	210 (8.3)	185 (7.3)	101 (4.0)	81 (3.2)	105 (4.1)	125 (4.9)	—	M6 (7×13 (0.28×0.51))	M8	7.4 (16)	
	DCR4-45B	B	171 (6.7)	110 (4.3)	165 (6.5)	125 (4.9)	110 (4.3)	150 (5.9)	210 (8.3)	M6 (ø8 (ø 0.31))	M8	18 (40)	
	DCR4-45C	D	210 (8.3)	185 (7.3)	106 (4.2)	86 (3.4)	120 (4.7)	125 (4.9)	—	M6 (7×13 (0.28×0.51))	M8	8.4 (19)	
	DCR4-55B	B	171 (6.7)	110 (4.3)	170 (6.7)	130 (5.1)	110 (4.3)	150 (5.9)	210 (8.3)	M6 (ø8 (ø 0.31))	M8	20 (44)	
	DCR4-55C	D	255 (10.0)	225 (8.9)	96 (3.8)	76 (3.0)	120 (4.7)	145 (5.7)	—	M6 (7×13 (0.28×0.51))	M10	11 (24)	
	DCR4-75C	D	255 (10.0)	225 (8.9)	106 (4.2)	86 (3.4)	125 (4.9)	145 (5.7)	—	M6 (7×13 (0.28×0.51))	M10	13 (29)	
	DCR4-90C	D	255 (10.0)	225 (8.9)	116 (4.6)	96 (3.8)	140 (5.5)	145 (5.7)	—	M6 (7×13 (0.28×0.51))	M12	15 (33)	
	DCR4-110C	D	300 (11.8)	265 (10.4)	116 (4.6)	90 (3.5)	175 (6.9)	155 (6.1)	—	M8 (10×18 (0.39×0.71))	M12	19 (42)	
	DCR4-132C	D	300 (11.8)	265 (10.4)	126 (5.0)	100 (3.9)	180 (7.1)	160 (6.3)	—	M8 (10×18 (0.39×0.71))	M12	22 (49)	
	DCR4-160C	D	350 (13.8)	310 (12)	131 (5.2)	103 (4.1)	180 (7.1)	190 (7.5)	—	M10 (12×22 (0.47×0.87))	M12	26 (57)	
	DCR4-200C	D	350 (13.8)	310 (12.2)	141 (5.6)	113 (4.4)	185 (7.3)	190 (7.5)	—	M10 (12×22 (0.47×0.87))	M12	30 (66)	
	DCR4-220C	D	350 (13.8)	310 (12.2)	146 (5.7)	118 (4.6)	200 (7.9)	190 (7.5)	—	M10 (12×22 (0.47×0.87))	M12	33 (73)	
	DCR4-250C	D	350 (13.8)	310 (12.2)	161 (6.3)	133 (5.2)	210 (8.3)	190 (7.5)	—	M10 (12×22 (0.47×0.87))	M12	35 (77)	
	DCR4-280C	D	350 (13.8)	310 (12.2)	161 (6.3)	133 (5.2)	210 (8.3)	190 (7.5)	—	M10 (12×22 (0.47×0.87))	M16	37 (82)	
DCR4-315C	D	400 (15.7)	345 (13.6)	146 (5.7)	118 (4.6)	200 (7.9)	225 (8.9)	—	M10 (12×22 (0.47×0.87))	M16	40 (88)		
DCR4-355C	E	400 (15.7)	345 (13.6)	156 (6.1)	128 (5.0)	200 (7.9)	225 (8.9)	—	M10 (12×22 (0.47×0.87))	4×M12	49 (108)		

11.11 AC Reactors (ACRs)

Use an ACR when the converter part of the inverter should supply very stable DC power, for example, in DC link bus operation (shared PN operation). Generally, ACRs are used for correction of voltage waveform and power factor or for power supply matching, but not for suppressing harmonic components in the power lines. For suppressing harmonic components, use a DCR. Please select in the capacity of the applicable motor selection of AC reactor.

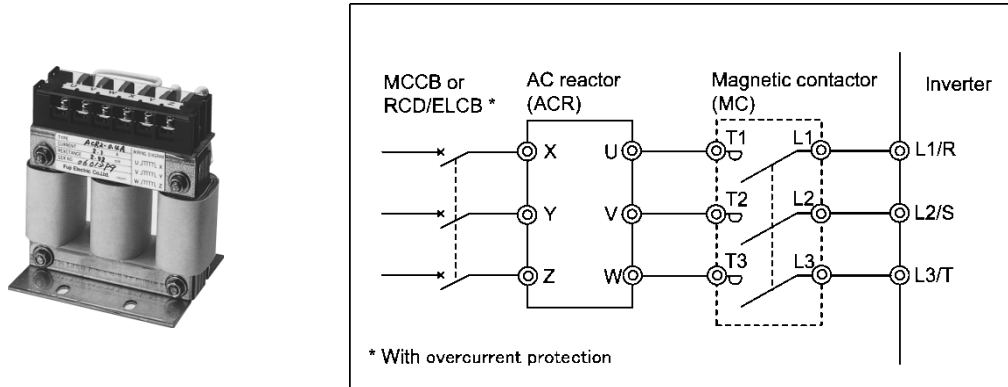

Figure 11.11-1 External View of AC Reactor (ACR) and Connection Example

Table 11.11-1 AC Reactor (ACR)

Power supply voltage	Nominal applied motor (kW)	Nominal applied motor (HP)	AC reactor type	Rated current (A)	Reactance (mΩ/phase)		Coil resistance (mΩ)	Generated loss (W)
					50Hz	60Hz		
Three-phase 200V	0.1	1/8	ACR2-0.4A	3	917	1100	-	2.5
	0.2	1/4						5
	0.4	1/2						10
	0.75	1	ACR2-0.75A	5	493	592	-	12
	1.5	2	ACR2-1.5A	8	295	354	-	14
	2.2	3	ACR2-2.2A	11	213	256	-	16
	3.0	4	ACR2-3.7A	17	218	153	-	23
	3.7	5						
	5.5	7.5	ACR2-5.5A	25	87.7	105	-	27
	7.5	10	ACR2-7.5A	33	65	78	-	30
	11	15	ACR2-11A	46	45.5	54.7	-	37
	15	20	ACR2-15A	59	34.8	41.8	-	43
	18.5	25	ACR2-18.5A	74	28.6	343	-	51
	22	30	ACR2-22A	87	24	28.8	-	57
30	40	ACR2-37	200	10.8	13	0.5	28.6	
Three-phase 400V	0.4	1/2	ACR4-0.75A	2.5	1920	2300	-	5
	0.75	1						10
	1.1	1-1/2	ACR4-1.5A	3.7	1160	1390	-	11
	1.5	2						
	2.2	3	ACR4-2.2A	5.5	851	1020	-	14
	3.0	4	ACR4-3.7A	9	512	615	-	17
	3.7	5						
	5.5	7.5	ACR4-5.5A	13	349	418	-	22
	7.5	10	ACR4-7.5A	18	256	307	-	27
	11	15	ACR4-11A	24	183	219	-	40
	15	20	ACR4-15A	30	139	167	-	46
	18.5	25	ACR4-18.5A	39	114	137	-	57
	22	30	ACR4-22A	45	95.8	115	-	62
	30	40	ACR4-37	100	41.7	50	2.73	38.9
	37	50	ACR4-37	100	41.7	50	2.73	55.7
	45	60	ACR4-55	135	30.8	37	1.61	50.2
	55	75	ACR4-55	135	30.8	37	1.61	70.7
	75	100	ACR4-75 *	160	25.8	31	1.16	65.3
	90	125	ACR4-110	250	16.7	20	0.523	42.2
	110	150	ACR4-110	250	16.7	20	0.523	60.3
132	200	ACR4-132 *	270	20.8	25	0.741	119	
160	250	ACR4-220	561	10	12	0.236	56.4	
200	300						90.4	
220	350						107	
250	400	ACR4-280	825	6.67	8	0.144	96.4	
280	450						108	
315	475	ACR4-355	825	6.67	8	0.144	194	
355	500							
Single-phase 200V	0.1	1/8	ACR2-0.4A	3	917	1100	-	5
	0.2	1/4						10
	0.4	1/2	ACR2-0.75A	5	493	592	-	12
	0.75	1	ACR2-1.5A	8	295	354	-	14
	1.5	2	ACR2-2.2A	11	213	256	-	16
	2.2	3	ACR2-3.7A	17	218	262	-	23
	3.7	5	ACR2-5.5A	25	87.7	105	-	27

* Cool this reactor using a fan with 3 m/s or more WV (Wind Velocity).

Note: Generated losses listed in the above table are approximate values that are calculated according to the following conditions:

- The power supply is three-phase 200V/400 V 50 Hz with 0% interphase voltage unbalance ratio.
- The capacity of the power supply used is the larger of either 500 kVA or 10 times the rated capacity of the inverter.
- The motor is a 4-pole standard model at full load (100%).

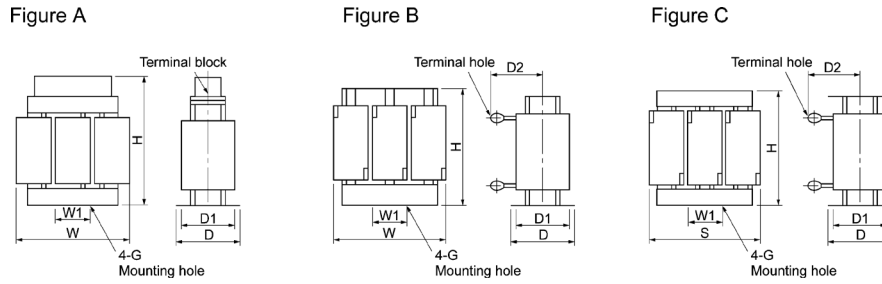

Table 11.11-2 AC Reactors (ACRs) External Dimensions

Power supply voltage	DC reactor type	Figure	Dimensions mm (inch)								Mass kg (lb)
			W	W1	D	D1	D2	G	H	Terminal hole	
Three-phase 200V	ACR2-0.4A	A	120 (4.7)	40 (1.6)	90 (3.5)	65 (2.6)	20 (0.79)	M5 (6×10 (0.24×0.39))	115 (4.5)	M4	1.4 (3.1)
	ACR2-0.75A		120 (4.7)	40 (1.6)	100 (3.9)	75 (3.0)	20 (0.79)	M5 (6×10 (0.24×0.39))	115 (4.5)	M4	1.9 (4.2)
	ACR2-1.5A		120 (4.7)	40 (1.6)	100 (3.9)	75 (3.0)	20 (0.79)	M5 (6×10 (0.24×0.39))	115 (4.5)	M4	2.0 (4.4)
	ACR2-2.2A		120 (4.7)	40 (1.6)	100 (3.9)	75 (3.0)	20 (0.79)	M5 (6×10 (0.24×0.39))	115 (4.5)	M4	2.0 (4.4)
	ACR2-3.7A		125 (4.9)	40 (1.6)	100 (3.9)	75 (3.0)	25 (0.98)	M5 (6×10 (0.24×0.39))	125 (4.9)	M4	2.4 (5.3)
	ACR2-5.5A		125 (4.9)	40 (1.6)	115 (4.5)	90 (3.5)	25 (0.98)	M5 (6×10 (0.24×0.39))	125 (4.9)	M4	3.1 (6.8)
	ACR2-7.5A		125 (4.9)	40 (1.6)	115 (4.5)	90 (3.5)	106 (4.2)	M5 (6×10 (0.24×0.39))	95 (3.7)	M5	3.1 (6.8)
	ACR2-11A		125 (4.9)	40 (1.6)	125 (4.9)	100 (3.9)	106 (4.2)	M5 (6×10 (0.24×0.39))	95 (3.7)	M6	3.7 (8.2)
	ACR2-15A		B	180 (7.1)	60 (2.4)	110 (4.3)	85 (3.3)	106 (4.2)	M6 (7×11 (0.28×0.43))	115 (4.5)	M6
	ACR2-18.5A	180 (7.1)		60 (2.4)	110 (4.3)	85 (3.3)	109 (4.3)	M6 (7×11 (0.28×0.43))	115 (4.5)	M6	5.1 (11)
	ACR2-22A	180 (7.1)		60 (2.4)	110 (4.3)	85 (3.3)	109 (4.3)	M6 (7×11 (0.28×0.43))	115 (4.5)	M6	5.1 (11)

Table 11.11-3 AC Reactors (ACRs) External Dimensions (continue)

Power supply voltage	DC reactor type	Figure	Dimensions mm (inch)								Mass kg (lb)
			W	W1	D	D1	D2	G	H	Terminal hole	
Three-phase 400V	ACR4-0.75A	B	120 (4.7)	40 (1.6)	90 (3.5)	65 (2.6)	106 (4.2)	M5 (6×10 (0.24×0.39))	85 (3.3)	M4	1.1 (2.4)
	ACR4-1.5A		125 (4.9)	40 (1.6)	100 (3.9)	75 (3.0)	106 (4.2)	M5 (6×10 (0.24×0.39))	85 (3.3)	M4	1.9 (4.2)
	ACR4-2.2A		125 (4.9)	40 (1.6)	100 (3.9)	75 (3.0)	106 (4.2)	M5 (6×10 (0.24×0.39))	95 (3.7)	M4	2.2 (4.9)
	ACR4-3.7A		125 (4.9)	40 (1.6)	100 (3.9)	75 (3.0)	106 (4.2)	M5 (6×10 (0.24×0.39))	95 (3.7)	M4	2.4 (5.3)
	ACR4-5.5A		125 (4.9)	40 (1.6)	115 (4.5)	90 (3.5)	106 (4.2)	M5 (6×10 (0.24×0.39))	95 (3.7)	M5	3.1 (6.8)
	ACR4-7.5A		125 (4.9)	40 (1.6)	115 (4.5)	90 (3.5)	106 (4.2)	M5 (6×10 (0.24×0.39))	95 (3.7)	M5	3.7 (8.2)
	ACR4-11A		180 (7.1)	60 (2.4)	110 (4.3)	85 (3.3)	106 (4.2)	M6 (7×11 (0.28×0.43))	115 (4.5)	M6	4.3 (9.5)
	ACR4-15A		180 (7.1)	60 (2.4)	110 (4.3)	85 (3.3)	106 (4.2)	M6 (7×11 (0.28×0.43))	137 (5.4)	M6	5.4 (12)
	ACR4-18.5A		180 (7.1)	60 (2.4)	110 (4.3)	85 (3.3)	106 (4.2)	M6 (7×11 (0.28×0.43))	137 (5.4)	M6	5.7 (13)
	ACR4-22A		180 (7.1)	60 (2.4)	110 (4.3)	85 (3.3)	106 (4.2)	M6 (7×11 (0.28×0.43))	137 (5.4)	M6	5.9 (13)
	ACR4-37		190 (7.5)	60 (2.4)	120 (4.7)	90 (3.5)	172 (6.8)	M6 (7×11 (0.28×0.43))	190 (7.5)	M8	12 (26)
	ACR4-55		190 (7.5)	60 (2.4)	120 (4.7)	90 (3.5)	200 (7.9)	M6 (7×11 (0.28×0.43))	190 (7.5)	M10	14 (31)
	ACR4-75		190 (7.5)	60 (2.4)	126 (5.0)	90 (3.5)	157 (6.2)	M6 (7×10 (0.28×0.39))	190 (7.5)	M10	16 (35)
	ACR4-110		250 (9.8)	100 (3.9)	136 (5.4)	105 (4.1)	202 (8.0)	M8 (9.5×18 (0.37×0.71))	245 (9.6)	M12	24 (53)
	ACR4-132	250 (9.8)	100 (3.9)	146 (5.7)	115 (4.5)	207 (8.1)	M8 (10×16 (0.39×0.63))	250 (9.8)	M12	32 (71)	
	ACR4-220	320 (12.6)	120 (4.7)	150 (5.9)	110 (4.3)	240 (9.4)	M8 (12×20 (0.47×0.79))	300 (11.8)	M12	40 (88)	
	ACR4-280	380 (15.0)	130 (5.1)	150 (5.9)	110 (4.3)	260 (10.2)	M8 (12×20 (0.47×0.79))	300 (11.8)	M12	52 (115)	
	ACR4-355	380 (15.0)	130 (5.1)	150 (5.9)	110 (4.3)	260 (10.2)	M8 (12×20 (0.47×0.79))	300 (11.8)	M12	52 (115)	

11.12 Surge Suppression Unit (SSU)



If the drive wire for the motor is long, an extremely low surge voltage (micro surge) occurs at the wire end connected to the motor. Surge voltage causes motor degradation, insulation breakdown, or increased noises. The surge suppression unit (SSU) suppresses the surge voltage. It features the connectivity for all inverter capacities and easy wiring work.

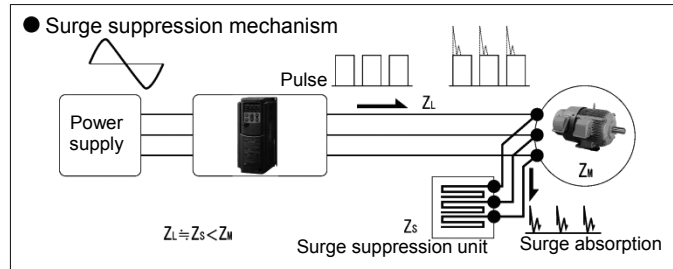

■ Dimensions

• 50 m spec: SSU 50TA-NS

• 100 m spec: SSU 100TA-NS

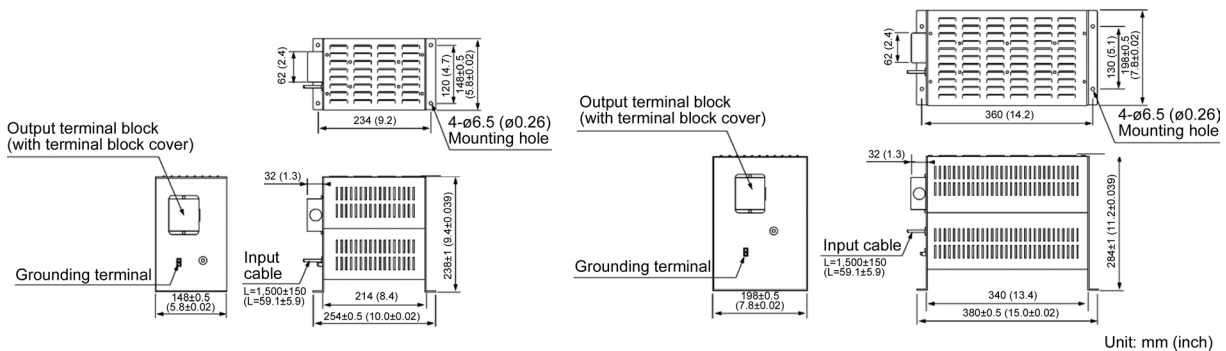

Unit: mm (inch)

■ Effects of surge suppression units (voltage waveform between motors)

- Motor/inverter capacity: 3.7 kW
- Running status: No-load
- Wiring length: 50 m
- Power supply voltage: Three-phase 400 V

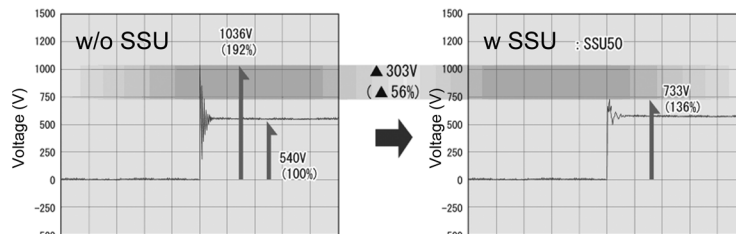

- Motor/inverter capacity: 75 kW
- Running status: No-load
- Wiring length: 100 m
- Power supply voltage: Three-phase 400 V

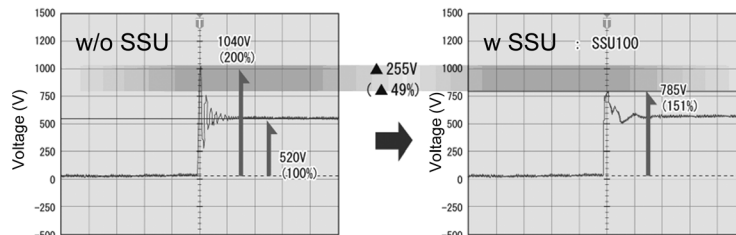

■ Basic specifications

Item	Specifications	
Type	SSU 50TA-NS	SSU 100TA-NS
Applicable wiring length	Up to 50 m (164 ft)	Up to 100 m (328 ft)
Power supply voltage	200 V and 400 V classes; PWM converter is applicable.	
Inverter capacity	Up to 75 kW (90 kW or larger requires customized service.)	
Output frequency	Up to 400 Hz	
Carrier frequency	Up to 15 kHz (Cannot be used at 16 kHz.)	
Enclosure	IP20	
Installation environment	Ambient temperature: -20 to +40°C, relative humidity: 85% RH or below, vibration: 0.7 G or less, Installation: horizontally	
Dielectric strength voltage	2500 VAC, 1 min	

11.13 Output Circuit Filters (OFLs)

Insert an OFL in the inverter power output circuit to:

- Suppress the surge voltage at motor terminals
This protects the motor from insulation damage caused by the application of high voltage surge currents from the 400 V class series of inverters.
- Suppress leakage current from the output lines
This reduces the leakage current from long power feed lines. (The maximum wiring length must be 400 m.)
- Minimize radiation and induction noise from the output lines
An OFL effectively suppresses noise from long lines such as wiring at plants.

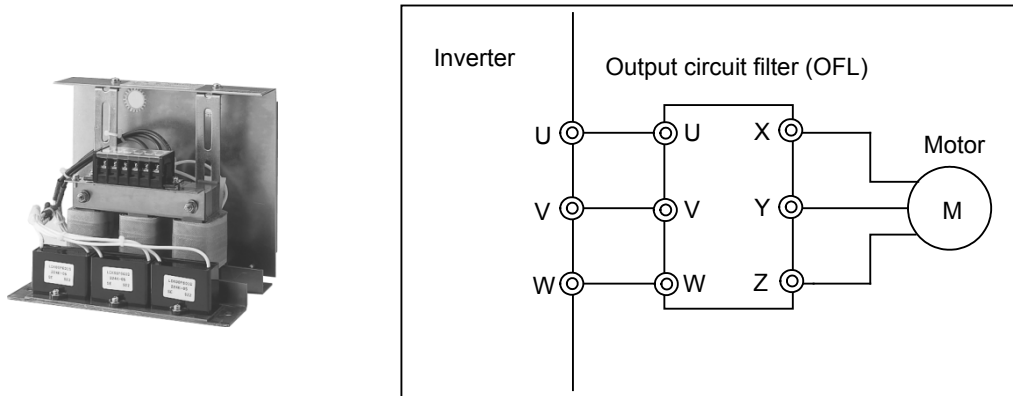

Figure 11.13-1 External View of Output Circuit Filter (OFL) and Connection Example

Table 11.13-1 Output Circuit Filter (OFL)

OFL-□□□-4A

Power supply voltage	Nominal applied motor (kW)	Filter type	Rated current (A)	Generated loss (kW)
Three-phase 400V	0.4	OFL-0.4-4A	1.5	80
	0.75	OFL-1.5-4A	3.7	105
	1.5			
	2.2	OFL-3.7-4A	9	210
	3.7			
	5.5	OFL-7.5-4A	18	190
	7.5			
	11	OFL-15-4A	30	320
	15			
	18.5	OFL-22-4A	45	350
	22			
	30	OFL-30-4A	60	570
	37	OFL-37-4A	75	610
	45	OFL-45-4A	91	810
	55	OFL-55-4A	112	910
	75	OFL-75-4A	150	1200
	90	OFL-90-4A	176	1360
	110	OFL-110-4A	210	1410
	132	OFL-132-4A	253	1800
	160	OFL-160-4A	304	2210
200	OFL-200-4A	377	2520	
220	OFL-220-4A	415	2590	
250	OFL-280-4A	520	3570	
280				
315	OFL-315-4A	585	3290	
355	OFL-355-4A	650	3320	

OFL-□□□-4A

■ Filter (for 22 kW or below)

■ Reactor (for 30 kW or above)

Figure A

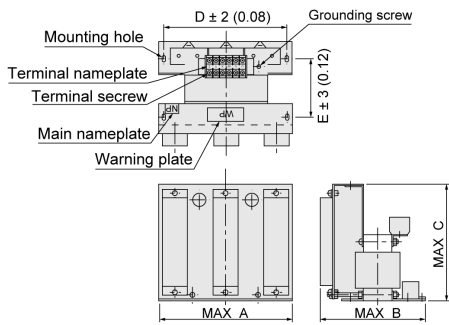

Figure B

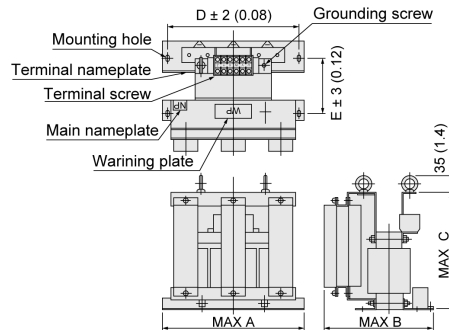

Figure C

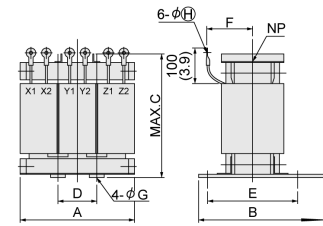

Figure D

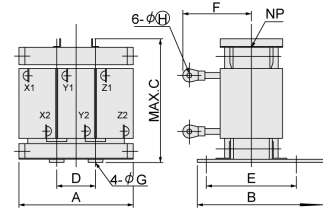
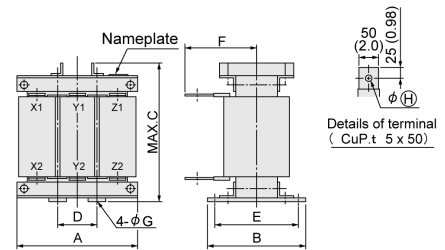
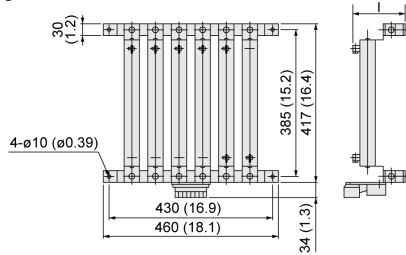

Figure E



■ Resistor and Capacitor (for 30 kW or above)

Figure F



For filters OFL-30-4A and greater, a reactor, resistor, and capacitor should be installed separately. (Those parts are not included in the mass of a filter. If ordered with the filter type, the filter is shipped in combination with a reactor, resistor, and capacitor.)

Figure G

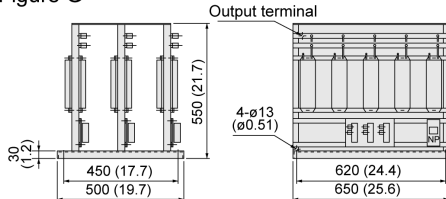

Filter type	Dimensions mm (inch)										
	Figure	A	B	C	D	E	F	G	Grounding screw H	Terminal screw J	Mounting screw K
OFL-0.4-4A	A	175 (6.9)	195 (7.7)	200 (7.9)	95 (3.7)				M4	M4	M5
OFL-1.5-4A		220 (8.7)	225 (8.9)	220 (8.7)	115 (4.5)						
OFL-3.7-4A		290 (11.4)	230 (9.1)	260 (10.2)	160 (6.3)				M5	M5	M6
OFL-7.5-4A		275 (10.8)	310 (12.2)	300 (11.8)	145 (5.7)						
OFL-15-4A	B	330 (13.0)	300 (11.8)	170 (6.7)					M6	M6	M8
OFL-22-4A		300 (11.8)	330 (13.0)	170 (6.7)							
OFL-30-4A	C/F	210 (8.3)	175 (6.9)	210 (8.3)	70 (2.8)	140 (5.5)	90 (3.5)	160 (6.3)		6.4 (0.25)	8 (0.31)
OFL-37-4A		220 (8.7)	190 (7.5)	220 (8.7)	75 (3)	150 (5.9)	95 (3.7)			8.4 (0.33)	10 (0.39)
OFL-45-4A	D/F	195 (7.7)	265 (10.4)	70 (2.8)	155 (6.1)	140 (5.5)		233 (9.2)		10.5 (0.41)	12 (0.47)
OFL-55-4A		200 (7.9)	275 (10.8)	85 (3.3)	160 (6.3)	150 (5.9)					
OFL-75-4A		210 (8.3)	290 (11.4)	170 (6.7)	155 (6.1)						
OFL-90-4A		230 (9.1)	330 (13.0)	190 (7.5)	170 (6.7)						
OFL-110-4A	E/G	300 (11.8)	240 (9.4)	340 (13.4)	100 (3.9)	200 (7.9)	180 (7.1)	333 (13.1)		13 (0.51)	15 (0.59)
OFL-132-4A		320 (12.6)	270 (10.6)	350 (13.8)	105 (4.1)	220 (8.7)	190 (7.5)				
OFL-160-4A		340 (13.4)	300 (11.8)	430 (16.9)	115 (4.5)	250 (9.8)	200 (7.9)				
OFL-200-4A		350 (13.8)	300 (11.8)	430 (16.9)	115 (4.5)	250 (9.8)	200 (7.9)				
OFL-220-4A	E/G	275 (10.8)	450 (17.7)	230 (9.1)	170 (6.7)			333 (13.1)		15 (0.59)	15 (0.59)
OFL-280-4A		290 (11.4)	480 (18.9)	245 (9.6)	175 (6.9)						
OFL-315-4A		440 (17.3)	295 (11.6)	510 (20.1)	150 (5.9)	240 (9.4)	175 (6.9)				
OFL-355-4A		325 (12.8)	470 (18.5)	270 (10.6)	195 (7.7)						
OFL-400-4A		335 (13.2)	500 (19.7)	280 (11.0)	210 (8.3)						

Note: The OFL-□□□-4A models have no restrictions on carrier frequency.

11.14 Zero-phase Reactors for Reducing Radio Noise (ACLs)

An ACL is used to reduce radio frequency noise emitted from the inverter output lines. Pass the total of four wires—three inverter output wires and a grounding wire through the ACL in the same passing direction four times. If shielded wires are used, pass them through the ACL with their shields four times. Be sure to use wires with a heat resistance of 75°C (167°F) or above.

The ACL absorbs high-frequency noise components and emits them as heat into the air so that the amount of heat generation can be large. If it happens, lower the carrier frequency, upgrade the heat-resistance rank of wires, increase the number of the ACLs to decrease the number of turns per ACL, replace the ACLs with higher type ones, or take any other measures.

The wire size is determined depending upon the ACL size (I.D.) and installation requirements. Refer to Table 11.14-1.

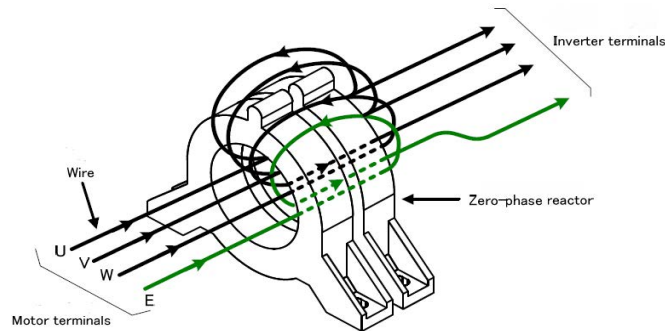
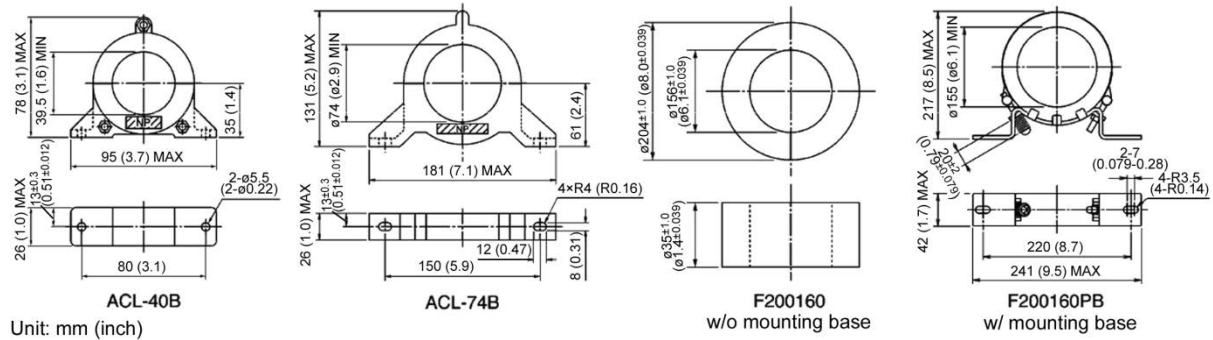

Figure 11.14-1 Dimensions of Zero-phase Reactor for Reducing Radio Noise (ACL) and Connection Example

Table 11.14-1 Zero-phase Reactors for Reducing Radio Noise (ACL)

ACL type	Installation requirements		Wire size (mm ²)	Wire size (AWG)
	Q'ty	Number of turns		
ACL-40B	1	4	5.5 or below	10 or below
	2	2	14 or below	6 or below
	4	1	38 or below	1 or below
ACL-74B	1	4	14 or below	6 or below
	2	2	60 or below	1/0 or below
	4	1	250 or below	500 or below

11.15 External Cooling Fan Attachments

An external cooling fan attachment for the FRENIC-Ace allows to mount the cooling fin outside the panel, which enhances cooling efficiency while making the panel smaller. It can release from the panel approximately 70% of the inverter's generated loss.

It cannot be used in the built-in EMC filter type.

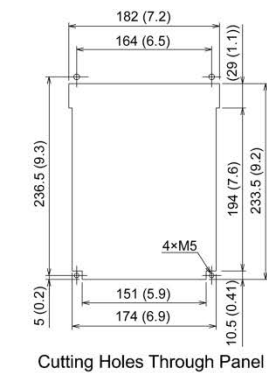
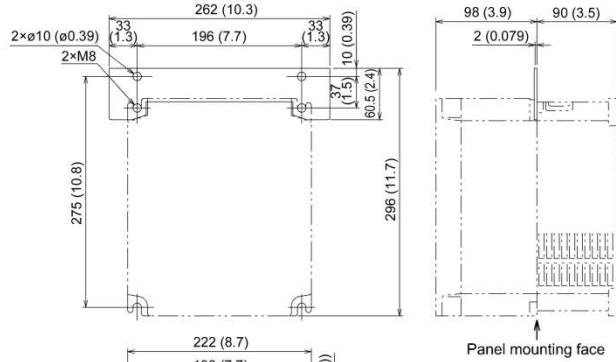
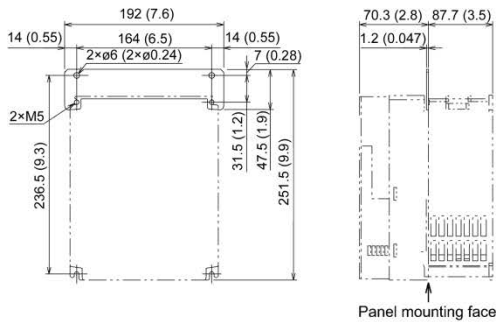

Model Name of Mounting Adapter	Applicable Inverter Type
PB-E1-7.5	FRN0030,0040E2S-2□ FRN0022,0029E2S-4□

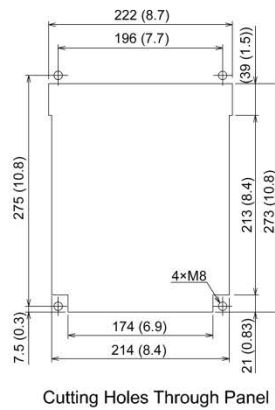

Model Name of Mounting Adapter	Applicable Inverter Type
PB-F1-15	FRN0056,0069E2S-2□ FRN0037,0044E2S-4□

Unit: mm (inch)

Cutting Holes Through Panel

11.15 External Cooling Fan Attachments

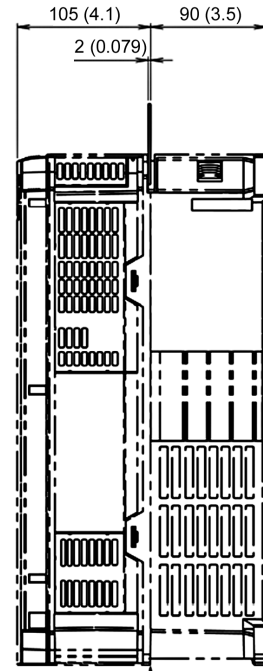
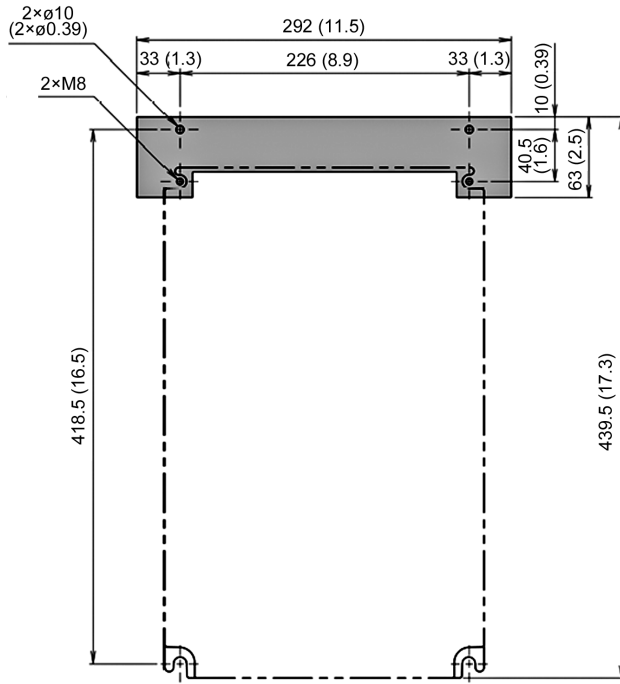

Panel mounting surface

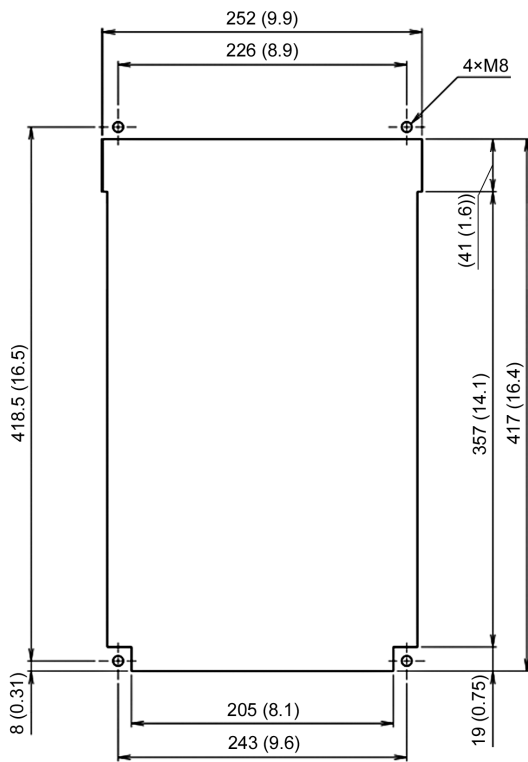

Panel processing diagram

Unit: mm (inch)

Option type	Applicable inverter type
PB-F1-30	FRN0059E2-4□
	FRN0072E2-4□

11.16 External Frequency Command Potentiometer

An external frequency command potentiometer may be used to set the drive frequency. Connect the potentiometer to control signal terminals [11] through [13] of the inverter as shown in Figure 11.16-1.

Type: RJ-13 (BA-2 B-characteristics, 1 kΩ)

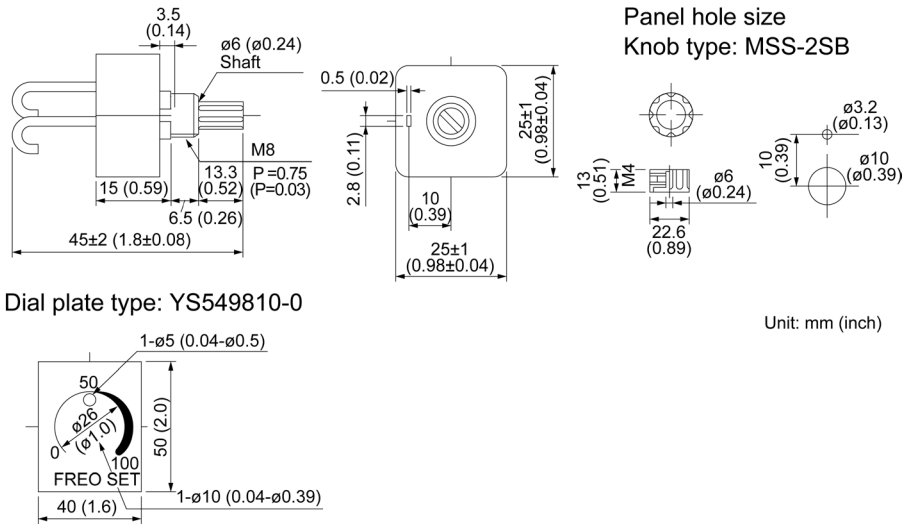

Note: The dial plate and knob must be ordered separately.
Available from Fuji Electric Technica Co., Ltd.

Type: WAR3W-1kΩ (3W B-characteristics)

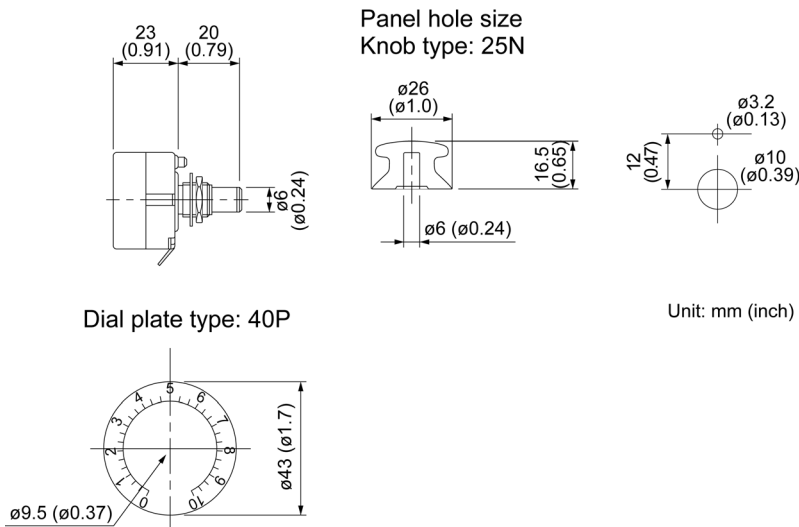

Note: The dial plate and knob must be ordered separately.
Available from Fuji Electric Technica Co., Ltd.

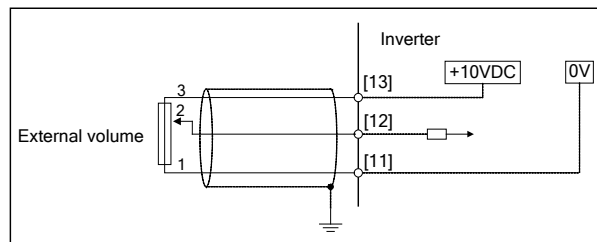

Figure 11.16-1 External Frequency Command Potentiometer Dimensions and Connection Example

11.17 Extension Cable for Remote Operation

The extension cable connects the inverter with the keypad (standard or multi-function) or USB-RS-485 converter to enable remote operation of the inverter. The cable is a straight type with RJ-45 jacks and its length is selectable from 5, 3, and 1 m.

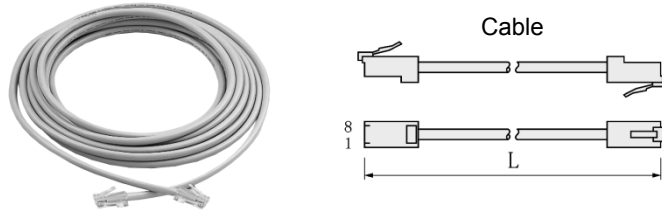

Table 11.17-1 Extension Cable Length for Remote Operation

Type	Length m (ft)
CB-5S	5 (16)
CB-3S	3 (9.8)
CB-1S	1 (3.3)

11.18 Frequency Meters

Connect a frequency meter to the analog signal output terminals [FM], [FM2] (for China only) and [11] of the inverter to measure the frequency component selected by function code F31 (FM), F35(FM2). Figure 11.8-1 shows the dimensions of the frequency meter and a connection example.

Type : TRM-45 (DC10V, 1mA)

This model has two types of calibration: "0 to 60/120 Hz" and "60/120/240 Hz."

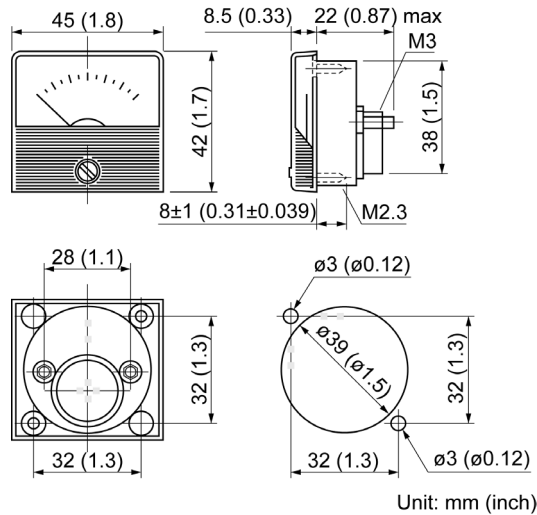

Unit: mm (inch)
Available from Fuji Electric Technica Co., Ltd.

Type : FMN-60 (10VDC, 1mA)

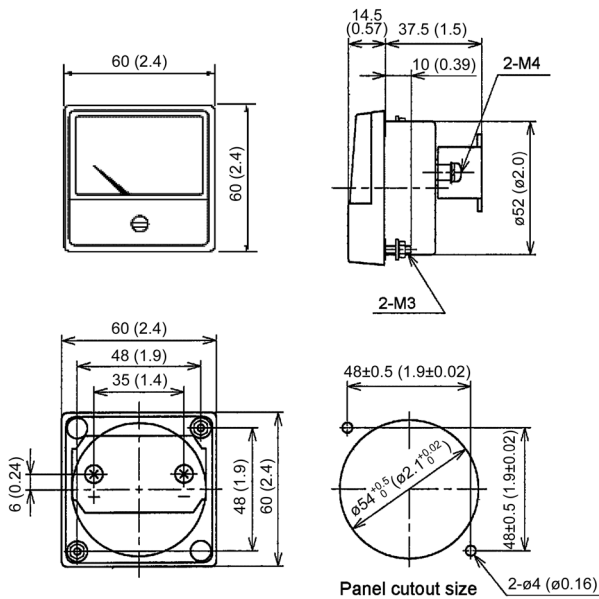

Type : FMN-80 (10VDC, 1mA)

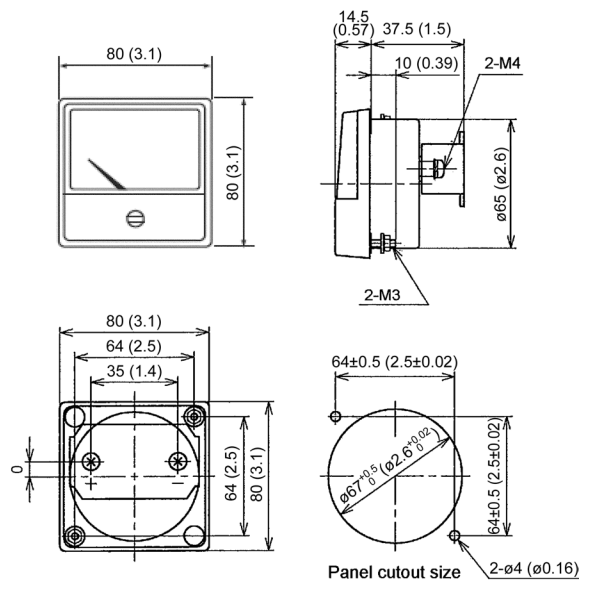

Unit: inch (mm) Available from Fuji Electric Technica Co., Ltd.

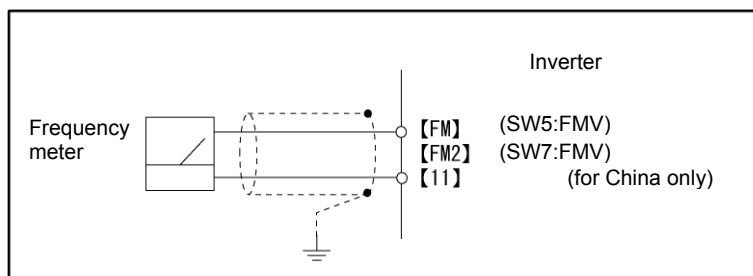

Figure 11.18-1 Frequency Meter Dimensions and Connection Example

11.19 Options for communication and operation overview

In FRENIC Ace it is possible to install one communication card and one terminal block type option card. A mounting adapter is required to install the communication card to the inverter.

11.19.1 Mounting adapter (for communication option card)

This adapter is required for mounting the communication option card to FRENIC-Ace.

Table 11.19-1

Type	Option Name	Functions
OPC-E2-ADP1	Option card mounting adapter for small-size inverter.	FRN0001E2■-2□ to FRN0069E2■-2□. FRN0002E2■-4□ to FRN0044E2■-4□. FRN0001E2■-7□ to FRN0011E2■-7□.
OPC-E2-ADP2	Option card mounting adapter for mid-size inverter.	FRN0059E2■-4□ and FRN0072E2■-4□.
OPC-E2-ADP3	Option card mounting adapter for large-size inverter.	FRN0085E2■-4□ or above.

11.19.2 Communication option cards (required mounting adapter required)

Table 11.19-2

Type	Option Name	Functions	Refer
OPC-DEV	DeviceNet communications card	This card enables the FRENIC-Ace to interface with DeviceNet and the FRENIC-Ace can be operated as a DeviceNet slave.	Section 11.20
OPC-CCL	CC-Link communications card	This card enables the FRENIC-Ace to interface with CC-Link and the FRENIC-Ace can be operated as a CC-Link slave.	Section 11.21
OPC-DIO	Digital I/O interface card	DI: The frequency set-point can be given by 8, 12 bits binary code or BCD code(0 to 99.9/0 to 999) and extended 13 digital inputs are available mounting this card. DO: The monitoring with 8bit binary code and the extended digital outputs (up to 8 outputs) are available.	Section 11.22
OPC-AIO	Analog I/O interface card	This card enables the FRENIC-Ace to input analog set-points to the inverter and output analog monitors.	Section 11.23
OPC-PDP3	PROFIBUS-DP communications card	This card enables the FRENIC-Ace to interface with PROFIBUS DP and the FRENIC-Ace can be operated as a PROFIBUS DP slave.	Comming soon.
OPC-ETH2	EtherNet/IP communications card	This card enables the FRENIC-Ace to interface with EtherNet and the FRENIC-Ace can be operated as a EtherNet slave.	Comming soon.
OPC-PRT	ProfiNet-RT communications card	This card enables the FRENIC-Ace to interface with ProfiNet-RT and the FRENIC-Ace can be operated as a ProfiNet-RT slave.	Comming soon.
OPC-COP	CANopen communications card	This card enables the FRENIC-Ace to interface with CANopen and the FRENIC-Ace can be operated as a CANopen slave. The built-in CAN cannot be used with PG option. However, CAN communication and PG option can be used at the same time by using this card.	Comming soon.

11.19.3 Terminal block type options

Table 11.19-3

Type	Option Name	Functions	Refer
OPC-E2-RS	RS485 communications card	This card provides two RS-485 connectors for multi-drop connection.	Section 11.24
OPC-E2-PG3	PG interface (12/15V) card	Speed control, position control and master- follower operation are available mounting this card in the inverter. <ul style="list-style-type: none"> • Open collector (pull-up resistor: 2350 Ω):30kHz • Complementary (totem-pole push-pull):100kHz • Voltage output : 12/15V 	Section 11.25
OPC-E2-PG	PG interface (5V) card	Speed control, position control and master- follower operation are available mounting this card in the inverter. <ul style="list-style-type: none"> • Open collector (pull-up resistor: 620 Ω):30kHz • Complementary (totem-pole push-pull):30kHz • Voltage output : 5V 	Section 11.26

11.19.4 Option keypad

Table 11.19-4

Type	Option Name	Functions	Refer
TP-E1U	Keypad with USB port.	The operation keypad adopted large-sized 7 segments LED to improve the visibility. Allows to connect a computer directly with a commercial USB cable (mini B) to be able to use FRENIC Loader software. Additional converter is not required. TP-E1U cannot be directly mounted on FRENIC-Ace. It can be connected only through a cable.	Section 11.27
TP-A1-E2C	Multi-functional keypad	The operation keypad adopted LCD(Liquid Crystal Display) with a back light. The keypad corresponds to multi-languages. TP-A1-E2C cannot be directly mounted on FRENIC-Ace. It can be connected only through a cable.	Section 11.28

11.20 DeviceNet communications card (OPC-DEV)

The DeviceNet communications card is used to connect the FRENIC-Ace series to a DeviceNet master via DeviceNet. Mounting the communications card on the FRENIC-Ace enables the user to control the FRENIC-Ace as a slave unit by configuring and monitoring run and frequency commands and accessing inverter's function codes from the DeviceNet master.

Note: Two or more communication cards cannot be mounted simultaneously. And this card requires a mounting adapter; refer to Section 11.19 .

Note: It is not possible to use the built-in CAN, if OPC-DEV card is to be installed.

Applicable ROM version

This communications card is applicable to inverters with a ROM version 0300 or later.

11.20.1 DeviceNet specifications

Table 11.20-1

Item	Specifications			
Number of nodes connectable	Max. 64 (including the master)			
MAC ID	0 to 63			
Insulation	500 VDC (photocoupler insulation)			
Transmission rate	500, 250, or 125 kbps			
Maximum cable length (When using thick cables)	Transmission rate	500 kbps	250 kbps	125 kbps
	Trunk line length	100 m (328 ft)	250 m (820 ft)	500m (1600 ft)
	Drop line length	6 m (20 ft)		
	Total length of drop lines	39 m (128 ft)	78 m (256 ft)	156 m (512 ft)
Messages supported	1. I/O Message (Poll, Change of State) 2. Explicit Message			
Vendor ID	319 (Registered name: Fuji Electric Group)			
Device type	AC drive (code: 2)			
Product code	9219			
Applicable device profile	AC Drive			
Number of input/output bytes	Max. 8 bytes for each of input and output. Depending on the format selected. Refer to Instruction manual of OPC-DEV.			
Applicable DeviceNet Specifications	CIP Specifications Volume 1, Edition 2.2 Japanese version and Volume 3, Edition 1.1 Japanese version			
Node type	Group 2 only server (noncompliant with UCMM)			
Network power consumption	80 mA, 24 VDC (Note) The network power is supplied by an external power source.			

For the items not contained in the table above, the DeviceNet Specifications apply.

11.21 CC-Link communications card (OPC-CCL)

CC-Link (Control & Communication Link) is an FA open field network system.

The CC-Link communications card connects the inverter to a CC-Link master via CC-Link using a dedicated cable. It supports the transmission speed of 156 kbps to 10 Mbps and the total length of 100 to 1,200 m so that it can be used in wide range of systems requiring a high-speed or long-distance transmission, enabling a flexible system configuration.

Note: Two or more communication cards cannot be mounted simultaneously. And this card requires a mounting adapter; refer to Section 11.19 .

Note: It is not possible to use the built-in CAN interface, if OPC-CCL card is to be installed.

Applicable ROM version

This communications card is applicable to inverters with a ROM version 0300 or later.

11.21.1 CC-Link specifications

Table 11.21-1

Item	Specifications				
Applicable controller	Mitsubishi Electric sequencer, etc. (CC-Link master)				
Transmission system	CC-Link version 1.10 and 2.0 (Broadcast polling system)				
Number of inverters connectable	Max. 42 units (one station occupied/unit)				
Number of stations occupied	CC-Link version 1.10: 1 station occupied CC-Link version 2.0: 1 station occupied (Selectable from among 2×, 4× and 8× settings)				
Transmission speed (Baud rate)	10 Mbps/5 Mbps/2.5 Mbps/625 kbps/156 kbps				
Maximum cable length (When using the CC-Link dedicated cable)	10 Mbps	5 Mbps	2.5 Mbps	625 kbps	156 kbps
	100 m (328 ft)	150 m (492 ft)	200 m (656 ft)	600 m (2000 ft)	1200 m (3900 ft)
Insulation	500 VDC (photocoupler insulation)				
Station type	Remote device station				
Remote device type	Inverter (0x20)				

For items not contained in the above table, the CC-Link specifications apply.

11.22 Digital I/O interface card (OPC-DIO)

This interface card can provide following features to the FRENIC-Ace series.

- (1) Available to set frequency point with binary (8,12bit) or BCD code.
- (2) Available to monitor with binary (8bit) code.
- (3) Available to extend the digital input terminals as I1 to I13.
- (4) Available to extend the transistor output terminals as O1 to O8.

Note: Two or more communication cards cannot be mounted simultaneously. And this card requires a mounting adapter; refer to Section 11.19 .

Applicable ROM version

This card is applicable to inverters with a ROM version 0300 or later.

Table 11.22-1 Terminal functions

Symbol	Name	Function
I1 to I13	Signal input	Terminals for setting input Extended digital input signals
M1	External power supply connect	External power supply connect
CM	Common of input The terminal CM is isolated to terminal M2.	Common terminal for setting input
O1 to O8	Output	Terminals for output monitor Extended transistor output signals
M2	Common of Output The terminal M2 is isolated to terminal CM.	Common terminals for output monitor

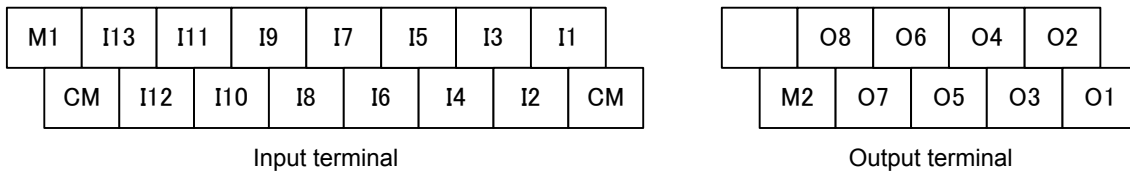

Figure 11.22-1 Terminal allocation on the DIO option interface card

Table 11.22-2 Electrical Specifications

Terminal Symbol	Item		Specification	
			min.	max.
I1 to I13	Operating voltage (SINK)	ON level	0V	2V
		OFF level	22V	27V
	Operating voltage (SOURCE)	ON level	22V	27V
		OFF level	0V	2V
	Operating current at ON.		2.5mA	4.5mA
Allowable leakage current at OFF		-	0.5mA	
O1 to O8	Operating voltage	At ON level	-	2V
		At OFF level	-	27V
	Maximum current at ON		-	50mA
	Leakage current at OFF		-	0.1mA

Table 11.22-3 Connecting Method input terminals

Power Supply	Connecting Method	
	Sink	Source
Internal		
External		

Table 11.22-4 Connecting Method output terminals

Sink	
Source	

11.23 Analog interface card (OPC-AIO)

The analog interface card has the terminals listed below. Mounting this interface card on the FRENIC-Ace enables analog input and analog output to/from the inverter.

- One analog voltage input point (0 to ± 10 V)
- One analog current input point (4 to 20 mA)
- One analog voltage output point (0 to ± 10 V)
- One analog current output point (4 to 20 mA)

Applicable ROM version

This interface card is applicable to inverters with a ROM version 0300 or later.

Table 11.23-1 Terminal functions

Classifications	Symbol	Name	Functions	Remarks
Analog input	[P10]	Power supply for the potentiometer	Power supply for frequency command potentiometer (Variable resistor: 1 to 5 k Ω) (10 VDC, 10 mA DC max.)	
	[32]	Analog voltage input	<ul style="list-style-type: none"> • Used as analog voltage input from external equipment. 0 to ± 10 VDC/0 to $\pm 100\%$ (0 to ± 5 VDC/0 to $\pm 100\%$) • One of the following signals can be assigned to this terminal. <ul style="list-style-type: none"> • Auxiliary frequency command • PID command, PID feedback value • Ratio setting • Torque limiter level, Torque bias amount • Torque command, Torque current command • Speed limit value of FWD, Speed limit value of REV • Analog input monitor • Resolution: 1/3000 	Input impedance: 22k Ω Max. input: ± 15 VDC
	[C2]	Analog current input	<ul style="list-style-type: none"> • Used as analog current input from external equipment. 4 to 20 mA DC/0 to 100% • One of the following signals can be assigned to this terminal. <ul style="list-style-type: none"> • Auxiliary frequency command • PID command, PID feedback value • Ratio setting • Torque limiter level, Torque bias amount • Torque command, Torque current command • Speed limit value of FWD, Speed limit value of REV • Analog input monitor • Resolution: 1/3000 	Input impedance: 250 Ω Max. input: 30 mA DC
	[31]	Analog common	• Reference terminal for [P10], [32], [C2].	Equipotent with the inverter's terminal [11]

Table 11.23-1 Terminal functions (cont.)

Classifications	Symbol	Name	Functions	Remarks
Analog output	[Ao+]	Analog voltage output (+)	<ul style="list-style-type: none"> Outputs the monitor signal of analog DC voltage (0 to ±10 VDC). One of the following signals can be issued from this terminal. <ul style="list-style-type: none"> Output frequency (before or after slip compensation) Output current, Output voltage, Output torque Load factor, Input power PID feedback value Actual speed / Estimated speed DC link bus voltage Universal AO Motor output Analog output test PID command, PID output Position deviation in master-follower operation Heat sink temperature PG feedback value Customizable logic output signal 1 to 4 Resolution: 1/3000 * Capable of driving up to two analog voltmeters with 10 kΩ impedance. 	
	[Ao-]	Analog voltage output (-)	<ul style="list-style-type: none"> Reference terminal for [Ao+]. 	Equipotent with the inverter's terminal [11]
	[CS+]	Analog current output (+)	<ul style="list-style-type: none"> Outputs the monitor signal of analog DC current (4 to 20 mA DC) One of the following signals can be issued from this terminal. <ul style="list-style-type: none"> Output frequency (before or after slip compensation) Output current, Output voltage, Output torque Load factor, Input power PID feedback value Actual speed / Estimated speed DC link bus voltage Universal AO Motor output Analog output test PID command, PID output Position deviation in master-follower operation Heat sink temperature PG feedback value Customizable logic output signal 1 to 4 Resolution: 1/3000 	Isolated from terminals [31], [Ao-], and [11]
	[CS-]	Analog current output (-)	<ul style="list-style-type: none"> * Input impedance of the external device: Max. 500Ω 	

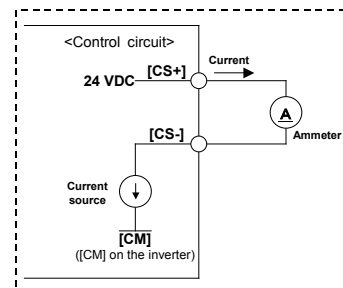

Table 11.23-2 Connection example

Symbol	Connection of shielded wire
[32]	<p>Shielded wire</p> <p>Potentiometer 1k to 5kΩ</p> <p>[P10] [32] [31]</p>
[C2]	<p>Shielded wire</p> <p>Constant current source 4 to 20 mA</p> <p>[C2] [31]</p>
[Ao]	<p>Shielded wire</p> <p>[Ao+] [Ao-]</p> <p>V</p>
[CS]	<p>Shielded wire</p> <p>[CS+] [CS-]</p> <p>A</p>

11.24 RS-485 communication card (OPC-E2-RS)

RS-485 communication card (OPC-E2-RS) expands RS-485 communication by RJ-45 connector with FRENIC-Ace as a standard into 2 connectors to facilitate multi-drop. RS-485 port of this option card cannot be connected to the keypad. In the same way as RS485 of the standard port, Fuji general-purpose inverter protocol, Modbus RTU protocol, and loader command are available.

Refer to RS-485 communication users manual for details of each protocol.

Table 11.24-1 RS-485 ports

[Connector pin arrangement]

Pin number	Pin symbol	
	SW10=1 (Factory default)	SW10=2
1,6,7,8	N.C.	
2	SD	
3	N.C.	DX-
4	DX-	DX+
5	DX+	N.C.

[Names and functions]

Pin names	Function
DX+	RS-485 communicationdata (+)
DX-	RS-485 communicationdata (-)
SD	This is the terminal for relaying the shield of the shielded cable, insulated from other circuits. The SD terminal in each connector.
N.C.	No connection

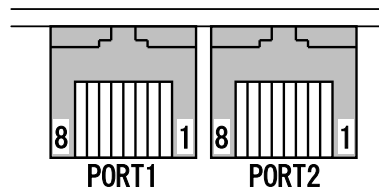

Figure 11.24-1 Pin assignment

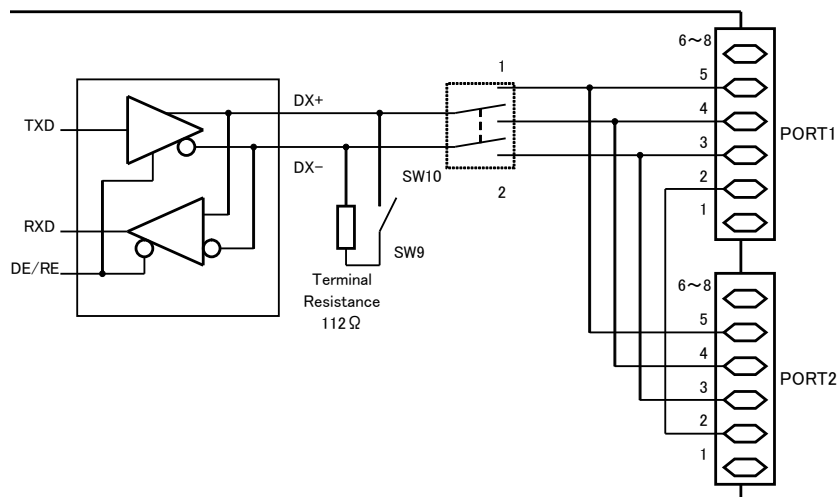

Figure 11.24-2 Internal circuit

■ **Constraints on standard control circuit terminal**

Control circuit terminal of OPC-E2-RS is different from some of the standard specification of FRENIC-Ace. Different specifications are as follows.

Table 11.24-2

Item	Specifications		
	Standard control circuit terminal		OPC-E2-RS
	FRN□□□□E2■-2/4/7GA	FRN□□□□E2■-2/4/7GB,-4C	
Analog output “ FM2 ”	N	Y	N
CAN-Open port	Y	N	N
RS-485 port	Y	Y	Y

11.25 PG interface card (OPC-E2-PG3)

This option card has the pulse (ABZ phase) input circuit of 2 systems and the power output circuit for PG (pulse generator).

By exchanging this option card with the control circuit terminal board that is installed in FRENIC-Ace main body as a standard, the following expansion functions can be used.

- (1) By the feedback signal by PG, speed control (vector control with speed sensor and PG, V/f control with speed sensor, peripheral speed constant control).
- (2) Simplified position control is possible by feedback signal of PG.
- (3) Master-follower synchronous drive is possible by feedback signal by pulse line input or PG.
- (4) Pulse line input is possible as the frequency command.

Refer to Chapter 5 for details of each function.

If this card is used, the pulse line input function of the inverter main body terminal X5 cannot be used.

Applicable ROM version

This interface card is applicable to inverters with a ROM version 0300 or later.

11.25.1 Interface specifications (feedback side, PG interface)

Table 11.25-1

Item	specifications	
Pulse format	A, B and Z-phase pulse trains in incremental format	
Pulse type	Open collector	Push pull (complementary)
frequency	30kHz (duty: 50±10%)	100kHz (duty: 50±10%)
Wire length *1	20m (66 ft) or less	30m (98 ft) or less (100kHz) 100m (328 ft) or less (30kHz)
pulse threshold	High level ≥ 8Vdc, Low level ≤ 3Vdc	
Number of pulse	20 to 3600P/R	20 to 3600P/R
PG power supply	+12V±10% / 80mA, +15V±10% / 60mA • If an encoder exceeding the above current has to be connected, it is necessary to use an external power supply. • The above current is the total value including the pulse line input interface side.	

*1: These values are approximate. They might be shorter depending on the wire type or noise environment.

11.25.2 Interface specifications (command side, pulse train interface)

Table 11.25-2

Item	specifications	
Pulse format	A, B and Z-phase pulse trains in incremental format	
Pulse type	Open collector	Push pull (complementary)
frequency	30kHz (duty : 50±10%)	100kHz (duty : 50±10%)
Wire length *1	20m (66 ft) or less	30m (98 ft) or less (100kHz) 100m (328 ft) or less (30kHz)
pulse threshold	High level ≥ 8Vdc, Low level ≤ 3Vdc	
Number of pulse	20 to 3600P/R	20 to 3600P/R
PG power supply	+12V±10% / 80mA, +15V±10% / 60mA • If an encoder exceeding the above current has to be connected, it is necessary to use an external power supply. The above current is the total value including the PG interface side.	

*1: These values are approximate. They might be shorter depending on the wire type or noise environment.

11.25.3 Constraints on standard control circuit terminal

Some control circuit terminals of OPC-E2-PG3 are different from the terminals of the standard specification of FRENIC-Ace. Different specifications are as follows.

Table 11.25-3

Item	Specifications		
	Standard control circuit terminal		OPC-E2-PG3
	FRN□□□□E2■-2/4/7GA	FRN□□□□E2■-2/4/7GB,-4C	
Power supply "PLC"	Power supply for digital input terminals, X1 to X5, FWD and REV. In addition, it can output 100mA (24V) for external devices.		Power supply for digital input terminals only
Digital input "X5"	Available as pulse train input.		Not available as pulse train input.
Analog output "FM2"	N	Y	N
CANopen	Y	N	N
RS-485	Y	Y	N

11.25.4 Terminal functions

Table 11.25-4

Function	Terminal	Symbol	Name	Specifications
Feedback side (PG interface)	TERM4	PO	Power output to PG	The external device power supply output. 12V/15V power output is possible.
		YA	A-Phase	Input terminal for A-phase pulse train feedback from PG
		YB	B-Phase	Input terminal for B-phase pulse train feedback from PG
		YZ	Z-Phase	Input terminal for Z-phase pulse train feedback from PG
		CM	common	Power supply common terminal of PG / pulse train / digital input. It is insulated from the terminal "11".
		PI	External power input	Power input terminal from the external device for PG. +12Vdc ±10% or, +15Vdc ±10%
Command side (pulse train interface)	TERM5	PO	Power output	The external device power supply output. 12V/15V power output is possible.
		XA	A-Phase	Input terminal for A-phase command pulse train
		XB	B-Phase	Input terminal for B-phase command pulse train
		XZ	-	Not used
		CM	common	Power supply common terminal of PG / pulse train / digital input. It is insulated from the terminal "11".

11.25.5 Connection diagram

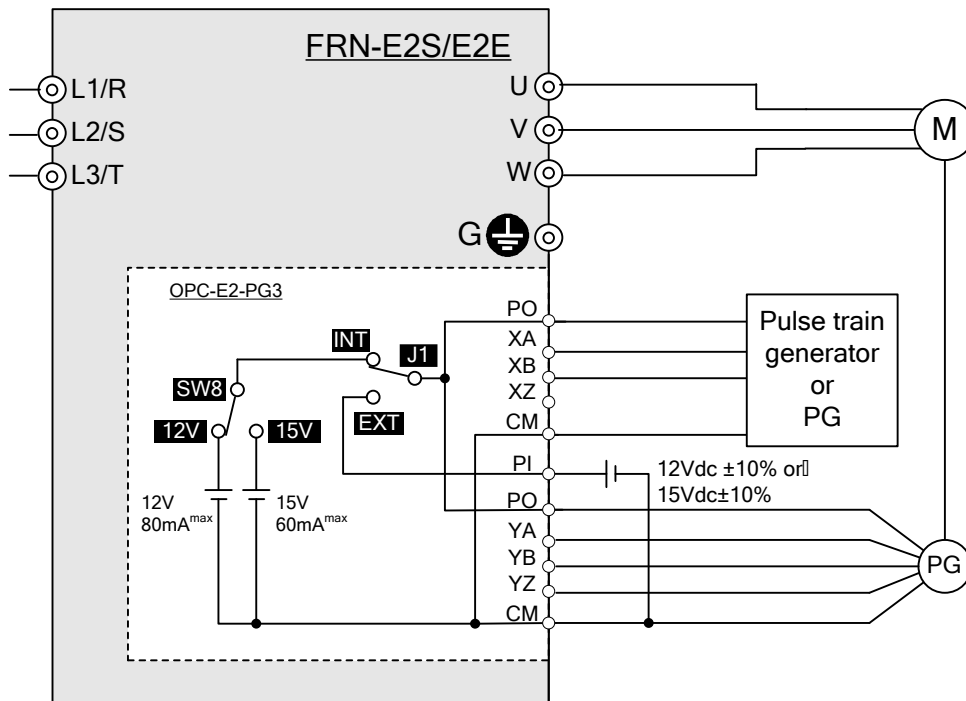
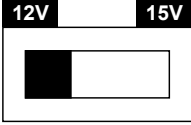
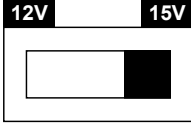
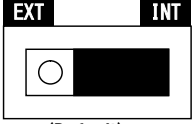
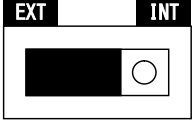

Figure 11.25-1

11.25.6 Voltage selection switch / Power supply selection jumper

Table 11.25-5

Symbol	Name	Specifications
SW8	Select voltage power supply	<p>+12Vdc±10% 80mA^{max} or +15Vdc±10% 60mA^{max}, selectable.</p> <div style="display: flex; justify-content: space-around; align-items: center;"> <div style="text-align: center;"> <p>【12V】</p>  <p>(Default)</p> </div> <div style="text-align: center;"> <p>【15V】</p>  </div> </div>
J1	Select internal/external power supply	<p>When connecting the apparatus exceeding internal current capability of PO terminal, it becomes connectable by using an external power supply connected to terminal PI.</p> <p>In this case, please change jumper J1 to EXT (External power supply capacity=power supply of device + 150mA)</p> <div style="display: flex; justify-content: space-around; align-items: center;"> <div style="text-align: center;"> <p>【INT】</p>  <p>(Default)</p> </div> <div style="text-align: center;"> <p>【EXT】</p>  </div> </div>

11.26 PG interface card (OPC-E2-PG)

This option card has the pulse (ABZ phase) input circuit of 2 systems and the power supply circuit for PG (pulse generator).

By exchanging this option card with the control circuit terminal board that is installed in FRENIC-Ace main body as a standard, the following expansion functions can be used.

- (1) By the feedback signal by PG, speed control (vector control with speed sensor and PG V/f control with speed sensor, peripheral speed constant control).
- (2) Simplified position control is possible by feedback signal of PG.
- (3) Master-follower synchronous drive is possible by feedback signal by pulse line input or PG.
- (4) Pulse line input is possible as the frequency command.

Refer to Chapter 5 for details of each function.

If this card is used, the pulse line input function of the inverter main body terminal X5 cannot be used.

Applicable ROM version

This interface card is applicable to inverters with a ROM version 0300 or later.

11.26.1 Interface specifications (feedback side, PG interface)

Table 11.26-1

Item	Specifications	
Pulse format	A, B and Z-phase pulse trains in incremental format	
Pulse type	Open collector	Push pull (complementary)
frequency	30kHz (duty: 50±10%)	
Wire length *1	20m (66 ft) or less	
Input pulse current	Maximum source current : -3mA(only complementary) Maximum sink current : 8mA	
pulse threshold	High level ≥ 3.5Vdc, Low level ≤ 1.5Vdc	
Number of pulse	20 to 3600P/R	
PG power supply	+5V±10% / 200mA <ul style="list-style-type: none"> ▪ If an encoder exceeding the above current has to be connected, it is necessary to use an external power supply (Encoder current + 150mAmax). ▪ The above current is the total value including the pulse line input interface side. 	

*1: These values are approximate. They might be shorter depending on the wire type or noise environment.

11.26.2 Interface specifications (command side, pulse train interface)

Table 11.26-2

Item	Specifications	
Pulse format	A, B and Z-phase pulse trains in incremental format	
Pulse type	Open collector	Push pull (complementary)
frequency	30kHz (duty : 50±10%)	
Wire length *1	20m (66 ft) or less	
Input pulse current	Maximum source current : -3mA(only complementary) Maximum sink current : 8mA	
pulse threshold	High level ≥ 3.5Vdc, Low level ≤ 1.5Vdc	
Number of pulse	20 to 3600P/R	
PG power supply	+5V±10% / 200mA <ul style="list-style-type: none"> ▪ If an encoder exceeding the above current is has to be connected, it is necessary to use an external power supply. The above current is the total value including the PG interface side. 	

*1: These values are approximate. They might be shorter depending on the wire type or noise environment.

11.26.3 Constraints on standard control circuit terminal

Some control circuit terminals of OPC-E2-PG are different from the terminals of the standard specification of FRENIC-Ace. Different specifications are as follows.

Table 11.26-3

Item	Specifications		
	Standard control circuit terminal		OPC-E2-PG
	FRN□□□□E2■-2/4/7GA	FRN□□□□E2■-2/4/7GB,-4C	
Power supply "PLC"	Power supply for digital input terminals, X1 to X5, FWD and REV. In addition, it can output 100mA (5V) for external devices.		Power supply for digital input terminals only
Digital input "X5"	Available as pulse train input.		Not available as pulse train input.
Analog output "FM2"	N	Y	N
CAN-Open	Y	N	N
RS-485	Y	Y	N

11.26.4 Terminal functions

Table 11.26-4

Function	Symbol	Name	Specifications
Feedback side (PG interface)	PO	Power output to PG	The external device power supply output. 5V power output is possible.
	YA	A-Phase	Input terminal for A-phase pulse train feedback from PG
	YB	B-Phase	Input terminal for B-phase pulse train feedback from PG
	YZ	Z-Phase	Input terminal for Z-phase pulse train feedback from PG
	CM	common	Power supply common terminal of PG / pulse train / digital input. It is insulated from the terminal "11".
	PI	External power input	Power input terminal from the external device for PG. +5Vdc±10%
Command side (pulse train interface)	PO	Power output	The external device power supply output. 5V power output is possible.
	XA	A-Phase	Input terminal for A-phase command pulse train
	XB	B-Phase	Input terminal for B-phase command pulse train
	XZ	-	Not used
	CM	common	Power supply common terminal of PG / pulse train / digital input. It is insulated from terminal "11".

11.26.5 Connection diagram

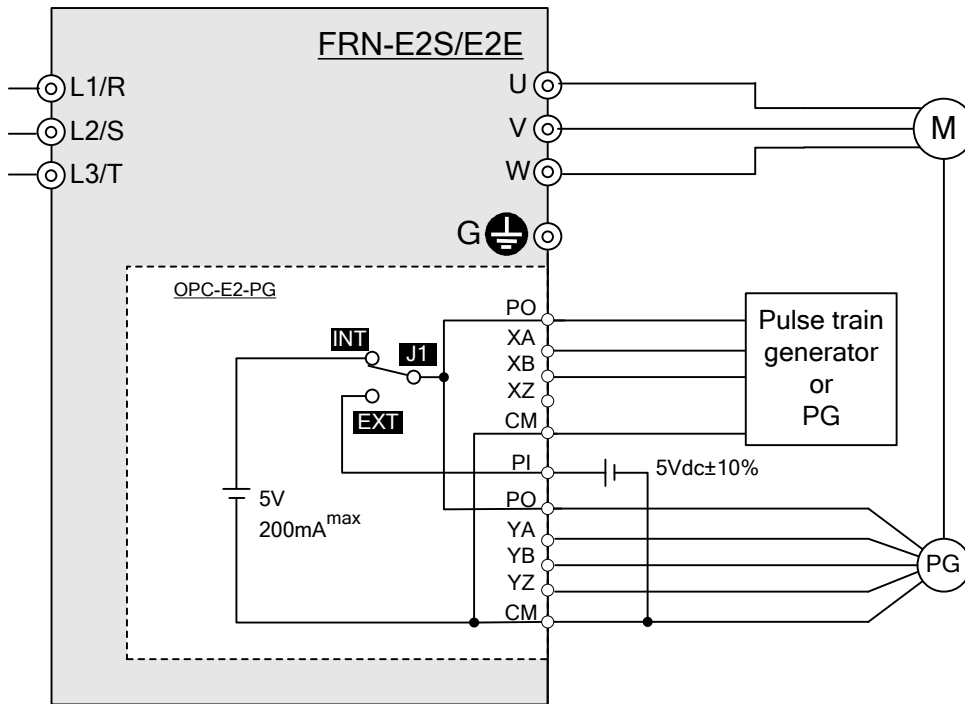

Figure 11.26-1

11.26.6 Power supply selection jumper

Table 11.26-5

Symbol	Name	Specifications
J1	Select internal/external power supply	<p>When connecting the apparatus exceeding internal current capability of PO terminal, it becomes connectable by using an external power supply connected to terminal PI.</p> <p>In this case, please change jumper J1 to EXT (External power supply capacity=power supply of device + 150mA)</p> <div style="text-align: center;"> </div>

11.27 Simple keypad with USB port (TP-E1U)

Using the keypad in combination with FRENIC Loader enables a variety of data about the inverter unit to be saved in the keypad memory, allowing you to check the information in any place.

TP-E1U cannot be directly mounted on FRENIC-Ace. It can be connected only through a cable.

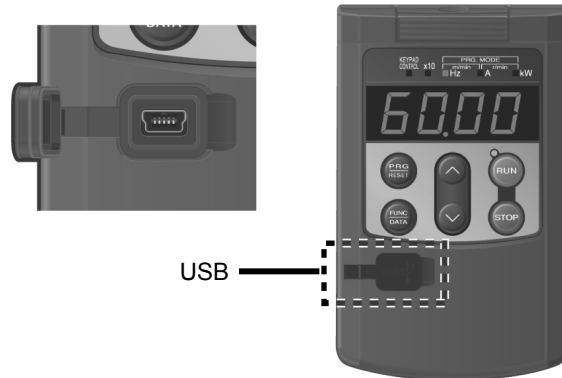

Features

- (1) The keypad can be directly connected to a computer through a commercial USB cable (mini B) without using a converter. The computer can be connected online with the inverter.
- (2) With the FRENIC Loader, the inverter can support the following functions (1) to (4).
 - 1) Editing, comparing, and copying the function code data
 - 2) Real-time operation monitor
 - 3) Trouble history (indicating the latest four troubles)
 - 4) Maintenance information

Data can be transferred from the USB port of the keypad directly to the computer (FRENIC Loader) at the site of production. Periodical collection of life information can be carried out efficiently

Dimensions

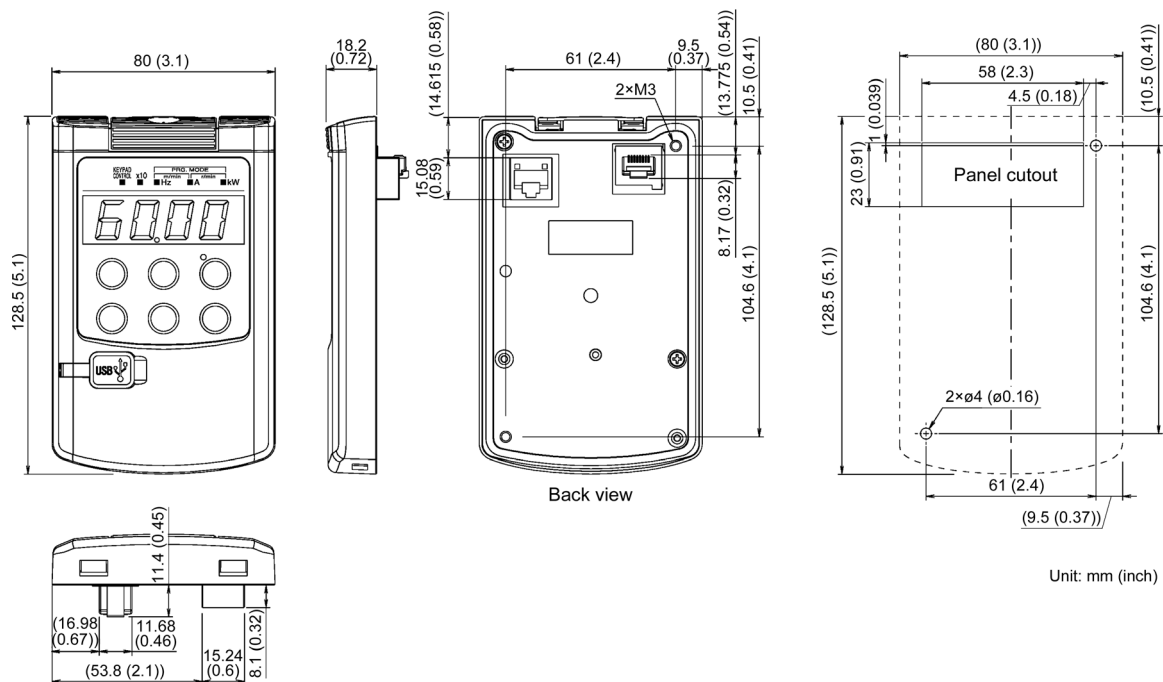

11.28 Multi functional keypad (TP-A1-E2C)

Replacing the standard keypad with the multi-function keypad enables setting and checking of function code data, and monitoring of the inverter running status, on the LCD monitor.

TP-A1-E2C cannot be directly mounted on FRENIC-Ace. It can be connected only through a cable.

Specifications

Items	Specifications	Remarks
Dimensions	Refer to the figures below	
Mass	120g	
Available languages	Japanese, English, Chinese	It is due to correspond to user-customized language.
Copy function	Possible to memorize or copy three function data sets.	
Applicable inverter	FRENIC-HVAC/AQUA series FRENIC-Ace series	Do not connect to FVR-E11S series otherwise Keypad or inverter may be damaged.
Number of connection	One inverter to one Multi-function keypad	
Connection cable	Conformed to ANSI/TIA/EIA568A Category 5 (For 10BASE-T/100BASE-TX straight connection)	Extension cable (CB-5S)
Extension cable length	20m or less	
Connector	RJ-45 connector	

External view, dimension

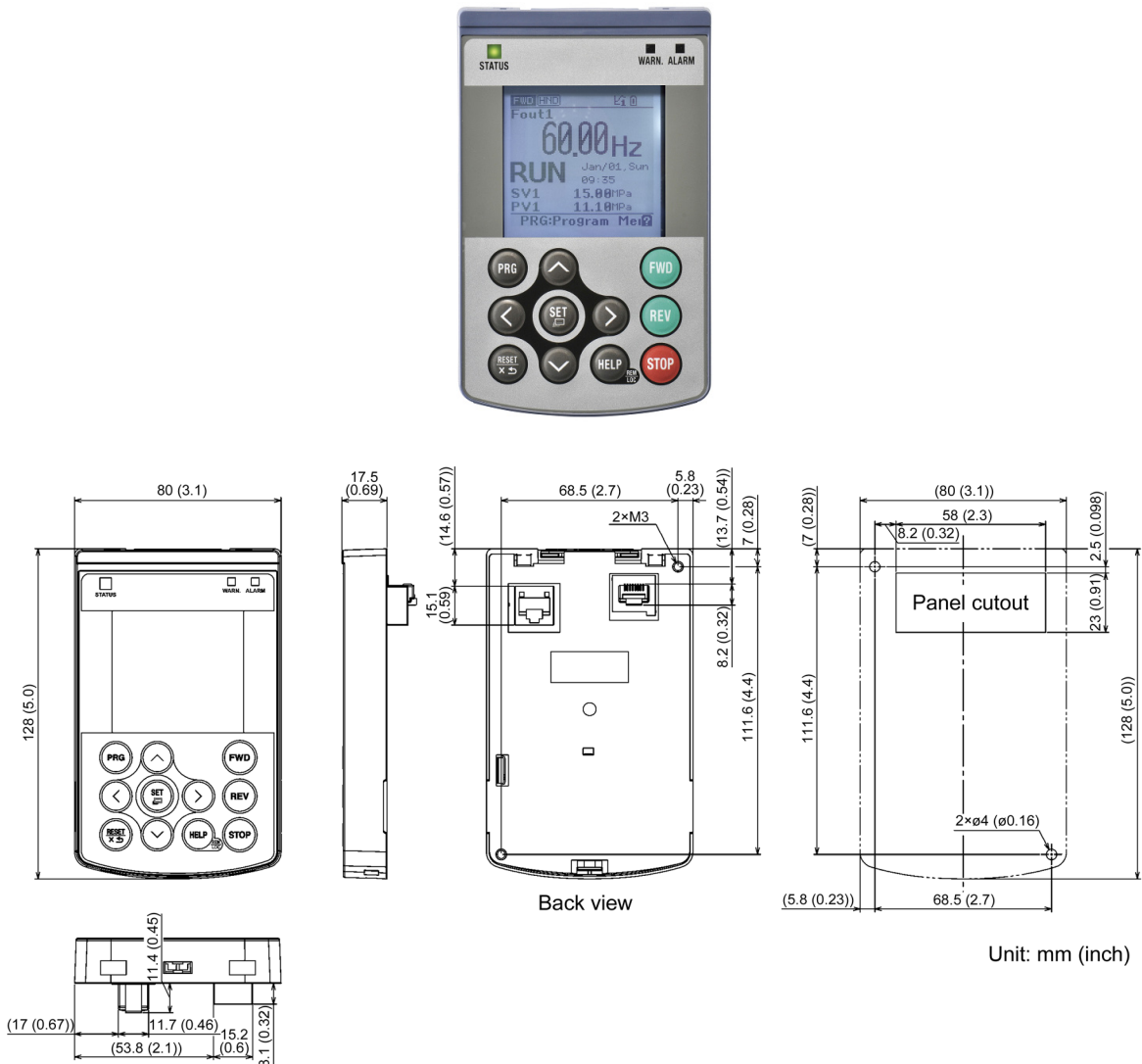

11.29 FRENIC Visual Customizer

11.29.1 Overview

FRENIC Visual Customizer is a inverter support software which can provide the visual customizing environment for FRENIC Ace.

Customers can modify their inverter easily with this software by themselves.

11.29.2 Specifications

Item	Specifications	Remarks
Name of software	FRENIC Visual Customizer	
No. of supported inverters	For USB connection: Only one inverter For RS-485 connection: Up to 31 inverters	
Recommended cable	USB : USB cable (mini B connector) RS-485 : Shielded twisted pair cable for long distance transmission	
Operating environment	OS *	Microsoft Windows XP(SP3 or later) Microsoft Windows Vista Microsoft Windows 7 ***
	Memory	512MB or more RAM 2GB or more is recommended
	Hard disk	35MB or more free space
	COM port	RS-232C or USB Conversion to RS-485 communications required to connect inverters
	Monitor resolution	800 × 600 or higher SXGA(1280 × 1024) / 32-bit color is recommended
Transmission requirements	COM port **	COM1 to COM255 PC COM ports assigned to Loader
	Transmission rates **	USB connection : Fixed at 12 Mbps RS-485 connection : 38400, 19200 , 9600, 4800 and 2400 bps 38400bps or more is recommended.
	Character length	8 bits Prefixed
	Stop bit length	1 bit Prefixed
	Parity	Even Prefixed
	No. of retries **	None or 1 to 10 No. of retry times before detecting communications error
	Timeout setting **	100ms, 300ms, 500ms, 1.0s to 1.5s to 1.9s, 2.0 to 9.0s, 10.0 to 60.0s This setting should be longer than the response interval time specified by the function code H39.

* Use on the PC downgraded to Windows XP from Windows7 or Windows Vista is not recommended.

** **Bolded, underlined** values are factory defaults.

*** Only support 32bit version of Windows XP, Windows Vista.
Support both 32bit and 64bit version of Windows 7.

11.29.3 Functions

This software can provide functions below.

Function	Overview
Customizable function editing	Draws functions and sends them to the inverter using a graphical editing tool.
Real-time trace	Displays the customizable function operation status with a waveform in real time.
Communication settings	Specifies settings for communicating with the inverter.

11.29.4 Main Window

The following window appears when the software is started.

Project management window
Manages project files and function properties.

Select Inverter
Inverter to be connected is selected.

Execution cycle
Displays the customizable functions execution time.

Toolbox
Selects function symbols used in the layout.

Update
Updates the latest number of steps.

Grid
Change grid size.

Zoom in / out
Zoom in / out the layout window.

Message window
Displays information such as the results of function code automatic assignment.

Clear log
Clear log of Message window.

Layout area
Draws functions with symbols added to the layout.

Chapter 12 SPECIFICATIONS

This chapter describes the output ratings, input power, basic functions and other specifications of the FRENIC-Ace standard and EMC Filter Built-in model.

Contents

12.1 Standard Model	12-1
12.1.1 ND-mode inverters for general load	12-1
12.1.2 HD-mode inverters for heavy duty load	12-4
12.1.3 HND-mode inverters for general load	12-7
12.1.4 HHD-mode inverters for heavy duty load	12-12
12.2 EMC Filter Built-in Type	12-18
12.2.1 ND-mode inverters for general load	12-18
12.2.2 HD-mode inverters for heavy duty load	12-18
12.2.3 HND-mode inverters for general load	12-19
12.2.4 HHD-mode inverters for heavy duty load	12-20
12.3 Common Specifications	12-21

12.1 Standard Model

12.1.1 ND-mode inverters for general load

■ Standard-model, Three-phase 400 V (460 V) class series (ND-mode: 0.75 kW to 5.5 kW)

Item		Specifications				
Type (FRN_ _ _ _ E2S-4□)		0002	0004	0006	0007	0012
Nominal applied motor (kW) [HP] (Output rating) *1		0.75 [1]	1.5 [2]	2.2 [3]	3.0 [4]	5.5 [7.5]
Output ratings	Rated capacity (kVA) *2	1.6 [1.7]	3.1 [3.3]	4.2 [4.4]	5.3 [5.5]	9.1 [9.6]
	Rated voltage (V) *3	Three-phase 380 to 480 V (with AVR function)				
	Rated current (A) *4	2.1	4.1	5.5	6.9	12
	Overload capability	120%-1 min				
Input power	Voltage, frequency	Three-phase 380 to 480 V, 50/60 Hz				
	Allowable voltage/frequency	Voltage: +10 to -15% (Interphase voltage unbalance: 2% or less) *6, Frequency: +5 to -5%				
	Rated input current (w/o DCR) (A) *7	2.7	4.8	7.3	11.3	16.8
	(with DCR) (A)	1.5	2.9	4.2	5.8	10.1
Required capacity (with DCR) (kVA) *8	1.1	2.1	3.0	4.1	7.0	
Braking	Torque (%) *9	53%	50%	48%	29%	27%
	DC braking	Braking starting frequency: 0.0 to 60.0 Hz, Braking time: 0.0 to 30.0 s, Braking level: 0 to 60%				
	Braking transistor	Built-in as standard				
	Minimum resistance value (Ω)	200		160		130
	Braking resistor	Separately mounted option				
DC reactor (DCR)	Separately mounted option					
Applicable safety standards	IEC/EN61800-5-1: 2007					
Enclosure (IEC60529)	IP20, UL open type					
Cooling method	Natural cooling			Fan cooling		
Weight / Mass (kg) [lbs]	1.2 [2.6]	1.5 [3.3]	1.5 [3.3]	1.6 [3.5]	1.9 [4.2]	

Note: A box (□) in the above table replaces GA, GB or C depending on the model.

- *1 Fuji 4-pole standard motor
- *2 Rated capacity is calculated assuming the rated output voltage as 440 V (460 V).
- *3 Output voltage cannot exceed the power supply voltage.
- *4 Setting the carrier frequency (F26) to the following value or above requires current derating.
ND spec. of all types : 4 kHz
If the ambient temperature is 40°C (104°F) or above, derating of 2%/°C (2%/1.8°F) relative to the rated current given in this manual is required. For details, refer to Chapter 10 "10.4.2 Guideline for selecting inverter drive mode and capacity."
- *6
$$\text{Voltage unbalance (\%)} = \frac{\text{Max. voltage (V)} - \text{Min. voltage (V)}}{\text{Three - phase average voltage (V)}} \times 67$$
 (IEC 61800-3)
If the unbalance ratio is 2% to 3%, use an optional AC reactor (ACR).
- *7 This specification is an estimated value to be applied when the power supply capacity is 500 kVA (Inverter capacity × 10 when the capacity exceeds 50 kVA) and the power supply with %X = 5% is connected.
- *8 This specification applies when a DC reactor (DCR) is used.
- *9 Average braking torque for the motor running alone. It depends on the efficiency of the motor.

■ Standard-model, Three-phase 400 V (460 V) class series (ND-mode: 11 kW to 55 kW)

Item		Specifications								
Type (FRN_ _ _ _E2S-4□)		0022	0029	0037	0044	0059	0072	0085	0105	
Nominal applied motor (kW) [HP] (Output rating) *1		11 [15]	15 [20]	18.5 [25]	22 [30]	30 [40]	37 [50]	45 [60]	55 [75]	
Output ratings	Rated capacity (kVA) *2	16 [17]	22 [23]	28 [29]	34 [35]	45 [47]	55 [57]	65 [68]	80 [84]	
	Rated voltage (V) *3	Three-phase 380 to 480 V (with AVR function)								
	Rated current (A) *4	21.5	28.5	37.0	44.0	59.0	72.0	85.0	105	
	Overload capability	120%-1 min								
Input power	Voltage, frequency	Three-phase 380 to 480 V, 50/60 Hz								
	Allowable voltage/frequency	Voltage: +10 to -15% (Interphase voltage unbalance: 2% or less) *6, Frequency: +5 to -5%								
	Rated input current (w/o DCR) (A) *7	33.0	43.8	52.3	60.6	77.9	94.3	114	140	
	(with DCR) (A)	21.1	28.8	35.5	42.2	57.0	68.5	83.2	102	
Required capacity (with DCR) (kVA) *8	15	20	25	29	39	47	58	71		
Braking	Torque (%) *9	12%					5% to 9%			
	DC braking	Braking starting frequency: 0.0 to 60.0 Hz, Braking time: 0.0 to 30.0 s, Braking level: 0 to 60%								
	Braking transistor	Built-in as standard						Separately mounted option		
	Minimum resistance value (Ω)	80	60	40	34.4	16		-	-	
	Braking resistor	Separately mounted option								
DC reactor (DCR)	Separately mounted option									
Applicable safety standards	IEC/EN61800-5-1: 2007									
Enclosure (IEC60529)	IP20, UL open type						IP00, UL open type			
Cooling method	Fan cooling									
Weight / Mass (kg) [lbs]	5.0 [11]	5.0 [11]	8.0 [18]	9.0 [20]	9.5 [21]	10 [22]	25 [55]	26 [57]		

Note: A box (□) in the above table replaces GA, GB or C depending on the model.

*1 Fuji 4-pole standard motor

*2 Rated capacity is calculated assuming the rated output voltage as 440 V (460 V).

*3 Output voltage cannot exceed the power supply voltage.

*4 Setting the carrier frequency (F26) to the following value or above requires current derating.

ND spec. of all types: 4 kHz

If the ambient temperature is 40°C (104°F) or above, derating of 2%/°C (2%/1.8°F) relative to the rated current given in this manual is required. For details, refer to Figure 10.4-1 in Chapter 10 "10.4.2 Guideline for selecting inverter drive mode and capacity."

*6 Voltage unbalance (%) = $\frac{\text{Max. voltage (V)} - \text{Min. voltage (V)}}{\text{Three - phase average voltage (V)}} \times 67$ (IEC 61800-3)

If the unbalance ratio is 2% to 3%, use an optional AC reactor (ACR).

*7 This specification is an estimated value to be applied when the power supply capacity is 500 kVA (Inverter capacity × 10 when the capacity exceeds 50 kVA) and the power supply with %X = 5% is connected. When applying with motors of 75 kW (100 HP) or above, a DC reactor (DCR) should be used.

*8 This specification applies when a DC reactor (DCR) is used.

*9 Average braking torque for the motor running alone. It depends on the efficiency of the motor.

■ Standard-model, Three-phase 400 V (460 V) class series (ND-mode: 75 kW to 315 kW)

Item		Specifications								
Type (FRN_ _ _ _E2S-4□)		0139	0168	0203	0240	0290	0361	0415	0520	0590
Nominal applied motor (kW) [HP] (Output rating) *1		75 [100]	90 [125]	110 [150]	132 [200]	160 [200]	200 [300]	220 [350]	280 [450]	315 [500]
Output ratings	Rated capacity (kVA) *2	106 [111]	128 [134]	155 [162]	183 [191]	221 [231]	275 [288]	316 [331]	396 [414]	450 [470]
	Rated voltage (V) *3	Three-phase 380 to 480 V (with AVR function)								
	Rated current (A) *4	139	168	203	240	290	361	415	520	590
	Overload capability	120%-1 min								
Input power	Voltage, frequency	Three-phase 380 to 480 V, 50/60 Hz			Three-phase 380 to 440 V, 50 Hz Three-phase 380 to 480 V, 60 Hz *5					
	Allowable voltage/frequency	Voltage: +10 to -15% (Interphase voltage unbalance: 2% or less) *6, Frequency: +5 to -5%								
	Rated input current (w/o DCR) (A) *7	–	–	–	–	–	–	–	–	–
	(with DCR) (A)	138	164	201	238	286	357	390	500	559
Required capacity (with DCR) (kVA) *8	96	114	139	165	199	248	271	347	388	
Braking	Torque (%) *9	5% to 9%								
	DC braking	Braking starting frequency: 0.0 to 60.0 Hz, Braking time: 0.0 to 30.0 s, Braking level: 0 to 60%								
	Braking transistor	Separately mounted option								
	Minimum resistance value (Ω)	–								
	Braking resistor	Separately mounted option								
DC reactor (DCR)	Must be used. Separately mounted component. Depending on the shipping destination, not provided with the inverter package. *11									
Applicable safety standards	IEC/EN61800-5-1: 2007									
Enclosure (IEC60529)	IP00, UL open type									
Cooling method	Fan cooling									
Weight / Mass (kg) [lbs]	30 [66]	33 [73]	40 [88]	62 [137]	63 [139]	95 [209]	96 [212]	130 [287]	140 [309]	

Note: A box (□) in the above table replaces GA, GB or C depending on the model.

- *1 Fuji 4-pole standard motor
- *2 Rated capacity is calculated assuming the rated output voltage as 440 V (460 V).
- *3 Output voltage cannot exceed the power supply voltage.
- *4 Setting the carrier frequency (F26) to the following value or above requires current derating.
ND spec. of all types : 4 kHz
If the ambient temperature is 40°C (104°F) or above, derating of 2%/°C (2%/1.8°F) relative to the rated current given in this manual is required. For details, refer to Figure 10.4-1 in Chapter 10 “10.4.2 Guideline for selecting inverter drive mode and capacity.”
- *5 Inverters of FRN0203E2■-4□ or above (400 V class series) are equipped with a power switching connector. Use the connector depending upon the applied voltage. For details, refer to Chapter 2 “2.2.7 Switching Connector.”
- *6
$$\text{Voltage unbalance (\%)} = \frac{\text{Max. voltage (V)} - \text{Min. voltage (V)}}{\text{Three - phase average voltage (V)}} \times 67 \text{ (IEC 61800-3)}$$

If the unbalance ratio is 2% to 3%, use an optional AC reactor (ACR).
- *7 This specification is an estimated value to be applied when the power supply capacity is 500 kVA (Inverter capacity × 10 when the capacity exceeds 50 kVA) and the power supply with %X = 5% is connected. When applying with motors of 75 kW (100 HP) or above, a DC reactor (DCR) should be used.
- *8 This specification applies when a DC reactor (DCR) is used.
- *9 Average braking torque for the motor running alone. It depends on the efficiency of the motor.
- *11 Please consult your Fuji Electric sales representative.

12.1.2 HD-mode inverters for heavy duty load

■ Standard-model, Three-phase 400 V (460 V) class series (HD-mode: 0.75 kW to 5.5 kW)

Item		Specifications				
Type (FRN_ _ _ _E2S-4□)		0002	0004	0006	0007	0012
Nominal applied motor (kW) [HP] (Output rating) *1		0.75 [1]	1.1 [1.5]	2.2 [3]	3.0 [4]	5.5 [7.5]
Output ratings	Rated capacity (kVA) *2	1.4 [1.4]	2.6 [2.7]	3.8 [4.0]	4.8 [5.0]	8.5 [8.8]
	Rated voltage (V) *3	Three-phase 380 to 480 V (with AVR function)				
	Rated current (A) *4	1.8	3.4	5.0	6.3	11.1
	Overload capability	150%-1 min				
Input power	Voltage, frequency	Three-phase 380 to 480 V, 50/60 Hz				
	Allowable voltage/frequency	Voltage: +10 to -15% (Interphase voltage unbalance: 2% or less) *6, Frequency: +5 to -5%				
	Rated input current (w/o DCR) (A) *7	2.7	3.9	7.3	11.3	16.8
	(with DCR) (A)	1.5	2.1	4.2	5.8	10.1
Required capacity (with DCR) (kVA) *8	1.1	1.5	3.0	4.1	7.0	
Braking	Torque (%) *9	53%	68%	48%	29%	27%
	DC braking	Braking starting frequency: 0.0 to 60.0 Hz, Braking time: 0.0 to 30.0 s, Braking level: 0 to 80%				
	Braking transistor	Built-in as standard				
	Minimum resistance value (Ω)	200		160		130
	Braking resistor	Separately mounted option				
DC reactor (DCR)	Separately mounted option					
Applicable safety standards	IEC/EN61800-5-1: 2007					
Enclosure (IEC60529)	IP20, UL open type					
Cooling method	Natural cooling			Fan cooling		
Weight / Mass (kg) [lbs]	1.2 [2.6]	1.5 [3.3]	1.5 [3.3]	1.6 [3.5]	1.9 [4.2]	

Note: A box (□) in the above table replaces GA, GB or C depending on the model.

*1 Fuji 4-pole standard motor

*2 Rated capacity is calculated assuming the rated output voltage as 440 V (460 V).

*3 Output voltage cannot exceed the power supply voltage.

*4 Setting the carrier frequency (F26) to the following value or above requires current derating.

HD spec. of all types : 4 kHz

If the ambient temperature is 40°C (104°F) or above, derating of 2%/°C (2%/1.8°F) relative to the rated current given in this manual is required. For details, refer to Figure 10.4-1 in Chapter 10 "10.4.2 Guideline for selecting inverter drive mode and capacity."

*6
$$\text{Voltage unbalance (\%)} = \frac{\text{Max. voltage (V)} - \text{Min. voltage (V)}}{\text{Three - phase average voltage (V)}} \times 67 \quad (\text{IEC 61800-3})$$

If the unbalance ratio is 2% to 3%, use an optional AC reactor (ACR).

*7 This specification is an estimate to be applied when the power supply capacity is 500 kVA (Inverter capacity × 10 when the capacity exceeds 50 kVA) and the power supply with %X = 5% is connected. When applying with motors of 75 kW (100 HP) or above, a DC reactor (DCR) should be used.

*8 This specification applies when a DC reactor (DCR) is used.

*9 Average braking torque for the motor running alone. It depends on the efficiency of the motor.

■ Standard-model, Three-phase 400 V (460 V) class series (HD-mode: 7.5 kW to 45 kW)

Item		Specifications							
Type (FRN_ _ _ _E2S-4□)		0022	0029	0037	0044	0059	0072	0085	0105
Nominal applied motor (kW) [HP] (Output rating) *1		7.5 [10]	11 [15]	15 [20]	18.5 [25]	22 [30]	30 [40]	37 [50]	45 [60]
Output ratings	Rated capacity (kVA) *2	13 [14]	18 [18]	24 [25]	29 [30]	34 [36]	46 [48]	57 [60]	69 [73]
	Rated voltage (V) *3	Three-phase 380 to 480 V (with AVR function)							
	Rated current (A) *4	17.5	23	31	38	45	60	75	91
	Overload capability	150%-1 min							
Input power	Voltage, frequency	Three-phase 380 to 480 V, 50/60 Hz							
	Allowable voltage/frequency	Voltage: +10 to -15% (Interphase voltage unbalance: 2% or less) *6, Frequency: +5 to -5%							
	Rated input current (w/o DCR) (A) *7	23.2	33.0	43.8	52.3	60.6	77.9	94.3	114
	(with DCR) (A)	14.4	21.1	28.8	35.5	42.2	57.0	68.5	83.2
Required capacity (with DCR) (kVA) *8	10	15	20	25	29	39	47	58	
Braking	Torque (%) *9	15%						7% to 12%	
	DC braking	Braking starting frequency: 0.0 to 60.0 Hz, Braking time: 0.0 to 30.0 s, Braking level: 0 to 80%							
	Braking transistor	Built-in as standard						Separately mounted option	
	Minimum resistance value (Ω)	80	60	40	34.4	16		-	-
	Braking resistor	Separately mounted option							
DC reactor (DCR)	Separately mounted option								
Applicable safety standards	IEC/EN61800-5-1: 2007								
Enclosure (IEC60529)	IP20, UL open type						IP00, UL open type		
Cooling method	Fan cooling								
Weight / Mass (kg) [lbs]	5.0 [11]	5.0 [11]	8.0 [18]	9.0 [20]	9.5 [21]	10 [22]	25 [55]	26 [57]	

Note: A box (□) in the above table replaces GA, GB or C depending on the model.

- *1 Fuji 4-pole standard motor
- *2 Rated capacity is calculated assuming the rated output voltage as 440 V (460 V).
- *3 Output voltage cannot exceed the power supply voltage.
- *4 Setting the carrier frequency (F26) to the following value or above requires current derating.
HD spec. of all types : 4 kHz
If the ambient temperature is 40°C (104°F) or above, derating of 2%/°C (2%/1.8°F) relative to the rated current given in this manual is required. For details, refer to Figure 10.4-1 in Chapter 10 "10.4.2 Guideline for selecting inverter drive mode and capacity."
- *6
$$\text{Voltage unbalance (\%)} = \frac{\text{Max. voltage (V)} - \text{Min. voltage (V)}}{\text{Three - phase average voltage (V)}} \times 67 \quad (\text{IEC 61800-3})$$

If the unbalance ratio is 2% to 3%, use an optional AC reactor (ACR).
- *7 This specification is an estimated value to be applied when the power supply capacity is 500 kVA (Inverter capacity × 10 when the capacity exceeds 50 kVA) and the power supply with %X = 5% is connected. When applying with motors of 75 kW (100 HP) or above, a DC reactor (DCR) should be used.
- *8 This specification applies when a DC reactor (DCR) is used.
- *9 Average braking torque for the motor running alone. It depends on the efficiency of the motor.

■ Standard-model, Three-phase 400 V (460 V) class series (HD-mode: 55 kW to 250 kW)

Item		Specifications								
Type (FRN_ _ _ _E2S-4□)		0139	0168	0203	0240	0290	0361	0415	0520	0590
Nominal applied motor (kW) [HP] (Output rating) *1		55 [75]	75 [100]	90 [125]	110 [150]	132 [200]	160 [250]	200 [300]	220 [350]	250 [400]
Output ratings	Rated capacity (kVA) *2	85 [89]	114 [120]	134 [140]	160 [167]	193 [202]	232 [242]	287 [300]	316 [331]	364 [380]
	Rated voltage (V) *3	Three-phase 380 to 480 V (with AVR function)								
	Rated current (A) *4	112	150	176	210	253	304	377	415	477
	Overload capability	150%-1 min								
Input power	Voltage, frequency	Three-phase 380 to 480 V, 50/60 Hz			Three-phase 380 to 440 V, 50 Hz Three-phase 380 to 480 V, 60 Hz *5					
	Allowable voltage/frequency	Voltage: +10 to -15% (Interphase voltage unbalance: 2% or less) *6, Frequency: +5 to -5%								
	Rated input current (w/o DCR) (A) *7	140	–	–	–	–	–	–	–	–
	(with DCR) (A)	102	138	164	201	238	286	357	390	443
Required capacity (with DCR) (kVA) *8	71	96	114	140	165	199	248	271	307	
Braking	Torque (%) *9	7% to 12%								
	DC braking	Braking starting frequency: 0.0 to 60.0 Hz, Braking time: 0.0 to 30.0 s, Braking level: 0 to 80%								
	Braking transistor	Separately mounted option								
	Minimum resistance value (Ω)	–								
	Braking resistor	Separately mounted option								
DC reactor (DCR)	Separately mounted option	Must be used. Separately mounted component. Depending on the shipping destination, not provided with the inverter package. *11								
Applicable safety standards	IEC/EN61800-5-1: 2007									
Enclosure (IEC60529)	IP00, UL open type									
Cooling method	Fan cooling									
Weight / Mass (kg) [lbs]	30 [66]	33 [73]	40 [88]	62 [137]	63 [139]	95 [209]	96 [212]	130 [287]	140 [309]	

Note: A box (□) in the above table replaces GA, GB or C depending on the model.

- *1 Fuji 4-pole standard motor
- *2 Rated capacity is calculated assuming the rated output voltage as 440 V (460 V).
- *3 Output voltage cannot exceed the power supply voltage.
- *4 Setting the carrier frequency (F26) to the following value or above requires current derating.
HD spec. of all types : 4 kHz
If the ambient temperature is 40°C (104°F) or above, derating of 2%/°C (2%/1.8°F) relative to the rated current given in this manual is required. For details, refer to Figure 10.4-1 in Chapter 10 "10.4.2 Guideline for selecting inverter drive mode and capacity."
- *5 Inverters of FRN0203E2■-4□ or above (400 V class series) are equipped with a power switching connector. Use the connector depending upon the applied voltage. For details, refer to Chapter 2 "2.2.7 Switching Connector."
- *6
$$\text{Voltage unbalance (\%)} = \frac{\text{Max. voltage (V)} - \text{Min. voltage (V)}}{\text{Three - phase average voltage (V)}} \times 67 \quad (\text{IEC 61800-3})$$

If the unbalance ratio is 2% to 3%, use an optional AC reactor (ACR).
- *7 This specification is an estimated value to be applied when the power supply capacity is 500 kVA (Inverter capacity × 10 when the capacity exceeds 50 kVA) and the power supply with %X = 5% is connected. When applying with motors of 75 kW (100 HP) or above, a DC reactor (DCR) should be used.
- *8 This specification applies when a DC reactor (DCR) is used.
- *9 Average braking torque for the motor running alone. It depends on the efficiency of the motor.
- *11 Please consult your Fuji Electric sales representative.

12.1.3 HND-mode inverters for general load

■ Standard-model, Three-phase 200 V (230 V) class series (HND-mode: 0.2 kW to 5.5 kW)

Item		Specifications						
Type (FRN_ _ _ _E2S-2□)		0001	0002	0004	0006	0010	0012 *10	0020 *10
Nominal applied motor (kW) [HP] (Output rating) *1		0.2 [1/4]	0.4 [1/2]	0.75 [1]	1.1 [1.5]	2.2 [3]	3.0 [4]	5.5 [7.5]
Output ratings	Rated capacity (kVA) *2	0.5 [0.5]	0.8 [0.8]	1.3 [1.4]	2.3 [2.4]	3.7 [3.8]	4.6 [4.8]	7.5 [7.8]
	Rated voltage (V) *3	Three-phase 200 to 240 V (with AVR function)						
	Rated current (A) *4	1.3	2.0	3.5	6.0	9.6	12	19.6
	Overload capability	120%-1 min						
Input power	Voltage, frequency	Three-phase 200 to 240 V, 50/60 Hz						
	Allowable voltage/frequency	Voltage: +10 to -15% (Interphase voltage unbalance: 2% or less) *6, Frequency: +5 to -5%						
	Rated input current (w/o DCR) (A) *7	1.8	2.6	4.9	6.7	12.8	17.9	31.9
	(with DCR) (A)	0.93	1.6	3.0	4.3	8.3	11.7	19.9
Required capacity (with DCR) (kVA) *8	0.4	0.6	1.1	1.5	2.9	4.1	6.9	
Braking	Torque (%) *9	75%		53%	68%	48%	29%	27%
	DC braking	Braking starting frequency: 0.0 to 60.0 Hz, Braking time: 0.0 to 30.0 s, Braking level: 0 to 80% (Type FRN0012E2S-2□ and FRN0020E2S-2□ : 0 to 60%)						
	Braking transistor	Built-in as standard						
	Minimum resistance value (Ω)	100			40		33	
	Braking resistor	Separately mounted option						
DC reactor (DCR)		Separately mounted option						
Applicable safety standards		IEC/EN61800-5-1: 2007						
Enclosure (IEC60529)		IP20, UL open type						
Cooling method		Natural cooling			Fan cooling			
Weight / Mass (kg) [lbs]		0.5 [1.1]	0.5 [1.1]	0.6 [1.3]	0.8 [1.8]	1.5 [3.3]	1.5 [3.3]	1.8 [4.0]

Note: A box (□) in the above table replaces GA, GB or C depending on the model.

- *1 Fuji 4-pole standard motor
- *2 Rated capacity is calculated assuming the rated output voltage as 220 V (230 V).
- *3 Output voltage cannot exceed the power supply voltage.
- *4 Setting the carrier frequency (F26) to the following value or above requires current derating.
HND/ND spec. of types FRN0001E2■-2□ to FRN0020E2■-2□ : 4 kHz,
If reduction is necessary, for details, refer to Chapter 10, Section 10.4.2 "Guideline for selecting inverter drive mode and capacity."
- *6 Voltage unbalance (%) = $\frac{\text{Max. voltage (V)} - \text{Min. voltage (V)}}{\text{Three - phase average voltage (V)}} \times 67$ (IEC 61800-3)
If the unbalance ratio is 2% to 3%, use an optional AC reactor (ACR).
- *7 This specification is an estimated value to be applied when the power supply capacity is 500 kVA (Inverter capacity × 10 when the capacity exceeds 50 kVA) and the power supply with %X = 5% is connected.
- *8 This specification applies when a DC reactor (DCR) is used.
- *9 Average braking torque for the motor running alone. It depends on the efficiency of the motor.
- *10 Types FRN0012E2■-2□ and FRN0020E2■-2□ are ND spec; allowable ambient temperature 40°C (+104°F) or less. The rated output current is decreased 1% for every 1°C (1.8°F) when ambient temperature is +40°C (+104°F) or more.

■ Standard-model, Three-phase 200 V (230 V) class series (HND-mode: 7.5 kW to 30 kW)

Item		Specifications					
Type (FRN_ _ _ _E2S-2□)		0030	0040	0056	0069	0088	0115
Nominal applied motor (kW) [HP] (Output rating) *1		7.5 [10]	11 [15]	15 [20]	18.5 [25]	22 [30]	30 [40]
Output ratings	Rated capacity (kVA) *2	11 [12]	15 [16]	21 [22]	26 [27]	34 [35]	44 [46]
	Rated voltage (V) *3	Three-phase 200 to 240 V (with AVR function)					
	Rated current (A) *4	30	40	56	69	88	115
	Overload capability	120%-1 min					
Input power	Voltage, frequency	Three-phase 200 to 240 V, 50/60 Hz					
	Allowable voltage/frequency	Voltage: +10 to -15% (Interphase voltage unbalance: 2% or less) *6, Frequency: +5 to -5%					
	Rated input current (w/o DCR) (A) *7	42.7	60.7	80.0	97.0	112	151
	(with DCR) (A)	28.8	42.2	57.6	71.0	84.4	114
Required capacity (with DCR) (kVA) *8	10	15	20	25	30	40	
Braking	Torque (%) *9	15%					
	DC braking	Braking starting frequency: 0.0 to 60.0 Hz, Braking time: 0.0 to 30.0 s, Braking level: 0 to 80%					
	Braking transistor	Built-in as standard					
	Minimum resistance value (Ω)	20	15	10	8.6	4	
	Braking resistor	Separately mounted option					
DC reactor (DCR)	Separately mounted option						
Applicable safety standards	IEC/EN61800-5-1: 2007						
Enclosure (IEC60529)	IP20, UL open type						
Cooling method	Fan cooling						
Weight / Mass (kg) [lbs]	5.0 [11]	5.0 [11]	8.0 [18]	9.0 [20]	9.5 [21]	10 [22]	

Note: A box (□) in the above table replaces GA, GB or C depending on the model.

*1 Fuji 4-pole standard motor

*2 Rated capacity is calculated assuming the rated output voltage as 220 V (230 V).

*3 Output voltage cannot exceed the power supply voltage.

*4 Setting the carrier frequency (F26) to the following value or above requires current derating.

HND spec of type FRN0030E2■-2□ to FRN0115E2■-2□: 10 kHz

HND spec of type FRN0088E2■-2□, FRN0115E2■-2□: 4 kHz

If reduction is necessary, for details, refer to Chapter 10 "10.4.2 Guideline for selecting inverter drive mode and capacity."

*6 Voltage unbalance (%) = $\frac{\text{Max. voltage (V)} - \text{Min. voltage (V)}}{\text{Three - phase average voltage (V)}} \times 67$ (IEC 61800-3)

If the unbalance ratio is 2% to 3%, use an optional AC reactor (ACR).

*7 This specification is an estimated value to be applied when the power supply capacity is 500 kVA (Inverter capacity × 10 when the capacity exceeds 50 kVA) and the power supply with %X = 5% is connected.

*8 This specification applies when a DC reactor (DCR) is used.

*9 Average braking torque for the motor running alone. It depends on the efficiency of the motor.

■ Standard-model, Three-phase 400 V (460 V) class series (HND-mode: 0.75 kW to 5.5 kW)

Item		Specifications				
Type (FRN_ _ _ _E2S-4□)		0002	0004	0006	0007 *10	0012 *10
Nominal applied motor (kW) [HP] (Output rating) *1		0.75 [1]	1.1 [1.5]	2.2 [3]	3.0 [4]	5.5 [7.5]
Output ratings	Rated capacity (kVA) *2	1.4 [1.4]	2.6 [2.7]	3.8 [4.0]	4.8 [5.0]	8.5 [8.8]
	Rated voltage (V) *3	Three-phase 380 to 480 V (with AVR function)				
	Rated current (A) *4	1.8	3.4	5.0	6.3	11.1
	Overload capability	120%-1 min				
Input power	Voltage, frequency	Three-phase 380 to 480 V, 50/60 Hz				
	Allowable voltage/frequency	Voltage: +10 to -15% (Interphase voltage unbalance: 2% or less) *6, Frequency: +5 to -5%				
	Rated input current (w/o DCR) (A) *7	2.7	3.9	7.3	11.3	16.8
	(with DCR) (A)	1.5	2.1	4.2	5.8	10.1
Required capacity (with DCR) (kVA) *8	1.1	1.5	3.0	4.1	7.0	
Braking	Torque (%) *9	53%	68%	48%	29%	27%
	DC braking	Braking starting frequency: 0.0 to 60.0 Hz, Braking time: 0.0 to 30.0 s, Braking level: 0 to 80% (Type FRN0007E2S-4□ and FRN0012E2S-4□ : 0 to 60%)				
	Braking transistor	Built-in as standard				
	Minimum resistance value (Ω)	200		160		130
	Braking resistor	Separately mounted option				
DC reactor (DCR)	Separately mounted option					
Applicable safety standards	IEC/EN61800-5-1: 2007					
Enclosure (IEC60529)	IP20, UL open type					
Cooling method	Natural cooling			Fan cooling		
Weight / Mass (kg) [lbs]	1.2 [2.6]	1.5 [3.3]	1.5 [3.3]	1.6 [3.5]	1.9 [4.2]	

Note: A box (□) in the above table replaces GA, GB or C depending on the model.

*1 Fuji 4-pole standard motor

*2 Rated capacity is calculated assuming the rated output voltage as 440 V (460 V).

*3 Output voltage cannot exceed the power supply voltage.

*4 Setting the carrier frequency (F26) to the following value or above requires current derating.

HND spec of type FRN0002E2■-4□ to FRN0006E2■-4□: 8 kHz,

ND spec of type FRN0007E2■-4□ to FRN0012E2■-4□: 4 kHz,

HND spec of type FRN0022E2■-4□ to FRN0059E2■-4□: 10 kHz,

HND spec of type FRN0072E2■-4□ to FRN0168E2■-4□: 6 kHz,

HND spec of type FRN0203E2■-4□ to FRN0590E2■-4□: 4 kHz

If reduction is necessary, for details, refer to Figure 10.4-1 in Chapter 10 "10.4.2 Guideline for selecting inverter drive mode and capacity."

*6 Voltage unbalance (%) = $\frac{\text{Max. voltage (V)} - \text{Min. voltage (V)}}{\text{Three - phase average voltage (V)}} \times 67$ (IEC 61800-3)

If the unbalance ratio is 2% to 3%, use an optional AC reactor (ACR).

*7 This specification is an estimated value to be applied when the power supply capacity is 500 kVA (Inverter capacity × 10 when the capacity exceeds 50 kVA) and the power supply with %X = 5% is connected. When applying with motors of 75 kW (100 HP) or above, a DC reactor (DCR) should be used.

*8 This specification applies when a DC reactor (DCR) is used.

*9 Average braking torque for the motor running alone. It depends on the efficiency of the motor.)

*10 Types FRN0007E2■-4□ and FRN0012E2■-4□ are ND spec; allowable ambient temperature 40°C (+104°F) or less. The rated output current is decreased 1% for every 1°C (1.8°F) when ambient temperature is +40°C (+104°F) or more.

■ Standard-model, Three-phase 400 V (460 V) class series (HND-mode: 7.5 kW to 45 kW)

Item		Specifications							
Type (FRN_ _ _ _E2S-4□)		0022	0029	0037	0044	0059	0072	0085	0105
Nominal applied motor (kW) [HP] (Output rating) *1		7.5 [10]	11 [15]	15 [20]	18.5 [25]	22 [30]	30 [40]	37 [50]	45 [60]
Output ratings	Rated capacity (kVA) *2	13 [14]	18 [18]	24 [25]	29 [30]	34 [36]	46 [48]	57 [60]	69 [73]
	Rated voltage (V) *3	Three-phase 380 to 480 V (with AVR function)							
	Rated current (A) *4	17.5	23	31	38	45	60	75	91
	Overload capability	120%-1 min							
Input power	Voltage, frequency	Three-phase 380 to 480 V, 50/60 Hz							
	Allowable voltage/frequency	Voltage: +10 to -15% (Interphase voltage unbalance: 2% or less) *6, Frequency: +5 to -5%							
	Rated input current (w/o DCR) (A) *7	23.2	33	43.8	52.3	60.6	77.9	94.3	114
	(with DCR) (A)	14.4	21.1	28.8	35.5	42.2	57.0	68.5	83.2
Required capacity (with DCR) (kVA) *8	10	15	20	25	29	39	47	58	
Braking	Torque (%) *9	15%						7% to 12%	
	DC braking	Braking starting frequency: 0.0 to 60.0 Hz, Braking time: 0.0 to 30.0 s, Braking level: 0 to 80%							
	Braking transistor	Built-in as standard						Separately mounted option	
	Minimum resistance value (Ω)	80	60	40	34.4	16		-	-
	Braking resistor	Separately mounted option							
DC reactor (DCR)	Separately mounted option								
Applicable safety standards	IEC/EN61800-5-1: 2007								
Enclosure (IEC60529)	IP20, UL open type						IP00, UL open type		
Cooling method	Fan cooling								
Weight / Mass (kg) [lbs]	5.0 [11]	5.0 [11]	8.0 [18]	9.0 [20]	9.5 [21]	10 [22]	25 [55]	26 [57]	

Note: A box (□) in the above table replaces GA, GB or C depending on the model.

*1 Fuji 4-pole standard motor

*2 Rated capacity is calculated assuming the rated output voltage as 440 V (460 V).

*3 Output voltage cannot exceed the power supply voltage.

*4 Setting the carrier frequency (F26) to the following value or above requires current derating.
HND spec of type FRN0022E2■-4□ to FRN0059E2■-4□: 10 kHz,
HND spec of type FRN0072E2■-4□ to FRN0168E2■-4□: 6 kHz,
HND spec of type FRN0203E2■-4□ to FRN0590E2■-4□: 4 kHz
If reduction is necessary, for details, refer to Figure 10.4-1 in Chapter 10 "10.4.2 Guideline for selecting inverter drive mode and capacity."

*6
$$\text{Voltage unbalance (\%)} = \frac{\text{Max. voltage (V)} - \text{Min. voltage (V)}}{\text{Three - phase average voltage (V)}} \times 67 \quad (\text{IEC 61800-3})$$

If the unbalance ratio is 2% to 3%, use an optional AC reactor (ACR).

*7 This specification is an estimated value to be applied when the power supply capacity is 500 kVA (Inverter capacity × 10 when the capacity exceeds 50 kVA) and the power supply with %X = 5% is connected. When applying with motors of 75 kW (100 HP) or above, a DC reactor (DCR) should be used.

*8 This specification applies when a DC reactor (DCR) is used.

*9 Average braking torque for the motor running alone. It depends on the efficiency of the motor.

■ Standard-model, Three-phase 400 V (460 V) class series (HND-mode: 55 kW to 280 kW)

Item		Specifications								
Type (FRN_ _ _ _E2S-4□)		0139	0168	0203	0240	0290	0361	0415	0520	0590
Nominal applied motor (kW) [HP] (Output rating) *1		55 [75]	75 [100]	90 [125]	110 [150]	132 [200]	160 [250]	200 [300]	220 [350]	280 [450]
Output ratings	Rated capacity (kVA) *2	85 [89]	114 [120]	134 [140]	160 [167]	193 [202]	232 [242]	287 [300]	316 [331]	396 [380]
	Rated voltage (V) *3	Three-phase 380 to 480 V (with AVR function)								
	Rated current (A) *4	112	150	176	210	253	304	377	415	520
	Overload capability	120%-1 min								
Input power	Voltage, frequency	Three-phase 380 to 480 V, 50/60 Hz			Three-phase 380 to 440 V, 50 Hz Three-phase 380 to 480 V, 60 Hz *5					
	Allowable voltage/frequency	Voltage: +10 to -15% (Interphase voltage unbalance: 2% or less) *6, Frequency: +5 to -5%								
	Rated input current (w/o DCR) (A) *7	140	–	–	–	–	–	–	–	–
	(with DCR) (A)	102	138	164	201	238	286	357	390	500
Required capacity (with DCR) (kVA) *8	71	96	114	140	165	199	248	271	347	
Braking	Torque (%) *9	7% to 12%								
	DC braking	Braking starting frequency: 0.0 to 60.0 Hz, Braking time: 0.0 to 30.0 s, Braking level: 0 to 80%								
	Braking transistor	Separately mounted option								
	Minimum resistance value (Ω)									
	Braking resistor	Separately mounted option								
DC reactor (DCR)	Separately mounted option	Must be used. Separately mounted component. Depending on the shipping destination, not provided with the inverter package. *11								
Applicable safety standards	IEC/EN61800-5-1: 2007									
Enclosure (IEC60529)	IP00, UL open type									
Cooling method	Fan cooling									
Weight / Mass (kg) [lbs]	30 [66]	33 [73]	40 [88]	62 [137]	63 [139]	95 [209]	96 [212]	130 [287]	140 [309]	

Note: A box (□) in the above table replaces GA, GB or C depending on the model.

- *1 Fuji 4-pole standard motor
- *2 Rated capacity is calculated assuming the rated output voltage as 440 V (460 V).
- *3 Output voltage cannot exceed the power supply voltage.
- *4 Setting the carrier frequency (F26) to the following value or above requires current derating.
HND spec of type FRN0022E2■-4□ to FRN0059E2■-4□: 10 kHz,
HND spec of type FRN0072E2■-4□ to FRN0168E2■-4□: 6 kHz,
HND spec of type FRN0203E2■-4□ to FRN0590E2■-4□: 4 kHz
If reduction is necessary, for details, refer to Figure 10.4-1 in Chapter 10 “10.4.2 Guideline for selecting inverter drive mode and capacity.”
- *5 Inverters of FRN0203E2■-4□ or above (400 V class series) are equipped with a power switching connector. Use the connector depending upon the applied voltage. For details, refer to Chapter 2 “2.2.7 Switching Connector.”
- *6 Voltage unbalance (%) = $\frac{\text{Max. voltage (V)} - \text{Min. voltage (V)}}{\text{Three-phase average voltage (V)}} \times 67$ (IEC 61800-3)
If the unbalance ratio is 2% to 3%, use an optional AC reactor (ACR).
- *7 This specification is an estimated value to be applied when the power supply capacity is 500 kVA (Inverter capacity × 10 when the capacity exceeds 50 kVA) and the power supply with %X = 5% is connected. When applying with motors of 75 kW (100 HP) or above, a DC reactor (DCR) should be used.
- *8 This specification applies when a DC reactor (DCR) is used.
- *9 Average braking torque for the motor running alone. It depends on the efficiency of the motor.
- *11 Please consult your Fuji Electric sales representative.

12.1.4 HHD-mode inverters for heavy duty load

■ Standard-model, Three-phase 200 V (230 V) class series (HHD-mode: 0.1 kW to 3.7 kW)

Item		Specifications						
Type (FRN____E2S-2□)		0001	0002	0004	0006	0010	0012	0020
Nominal applied motor (kW) [HP] (Output rating) *1		0.1 [1/8]	0.2 [1/4]	0.4 [1/2]	0.75 [1]	1.5 [2]	2.2 [3]	3.7 [5]
Output ratings	Rated capacity (kVA) *2	0.3 [0.3]	0.6 [0.6]	1.1 [1.2]	1.9 [2.0]	3.0 [3.2]	4.2 [4.4]	6.7 [7.0]
	Rated voltage (V) *3	Three-phase 200 to 240 V (with AVR function)						
	Rated current (A) *4	0.8	1.6	3.0	5.0	8.0	11	17.5
	Overload capability	150%-1 min, 200%-0.5 s						
Input power	Voltage, frequency	Three-phase 200 to 240 V, 50/60 Hz						
	Allowable voltage/frequency	Voltage: +10 to -15% (Interphase voltage unbalance: 2% or less) *6, Frequency: +5 to -5%						
	Rated input current (w/o DCR) (A) *7	1.1	1.8	3.1	5.3	9.5	13.2	22.2
	(with DCR) (A)	0.57	0.93	1.6	3.0	5.7	8.3	14.0
Required capacity (with DCR) (kVA) *8	0.2	0.4	0.6	1.1	2.0	2.9	4.9	
Braking	Torque (%) *9	150%		100%		70%	40%	
	DC braking	Braking starting frequency: 0.0 to 60.0 Hz, Braking time: 0.0 to 30.0 s, Braking level: 0 to 100%						
	Braking transistor	Built-in as standard						
	Minimum resistance value(Ω)	100			40		33	
	Braking resistor	Separately mounted option						
DC reactor (DCR)	Separately mounted option							
Applicable safety standards	IEC/EN61800-5-1: 2007							
Enclosure (IEC60529)	IP20, UL open type							
Cooling method	Natural cooling				Fan cooling			
Weight / Mass (kg) [lbs]	0.5 [1.1]	0.5 [1.1]	0.6 [1.3]	0.8 [1.8]	1.5 [3.3]	1.5 [3.3]	1.8 [4.0]	

Note: A box (□) in the above table replaces GA, GB or C depending on the model.

- *1 Fuji 4-pole standard motor
- *2 Rated capacity is calculated assuming the rated output voltage as 220 V (230 V).
- *3 Output voltage cannot exceed the power supply voltage.
- *4 Setting the carrier frequency (F26) to the following value or above requires current derating.
HHD spec. of types FRN0001E2■-2□ to FRN0020E2■-2□ : 8 kHz,
HHD spec. of types FRN0030E2■-2□ to FRN0115E2■-2□ : 10 kHz,
If reduction is necessary, for details, refer to Chapter 10, Section 10.4.2 "Guideline for selecting inverter drive mode and capacity."
- *6
$$\text{Voltage unbalance (\%)} = \frac{\text{Max. voltage (V)} - \text{Min. voltage (V)}}{\text{Three - phase average voltage (V)}} \times 67 \quad (\text{IEC 61800-3})$$

If the unbalance ratio is 2% to 3%, use an optional AC reactor (ACR).
- *7 This specification is an estimated value to be applied when the power supply capacity is 500 kVA (Inverter capacity × 10 when the capacity exceeds 50 kVA) and the power supply with %X = 5% is connected.
- *8 This specification applies when a DC reactor (DCR) is used.
- *9 Average braking torque for the motor running alone. It depends on the efficiency of the motor.

■ Standard-model, Three-phase 200 V (230 V) class series (HHD-mode: 5.5 kW to 22 kW)

Item		Specifications					
Type (FRN_ _ _ _E2S-2□)		0030	0040	0056	0069	0088	0115
Nominal applied motor (kW) [HP] (Output rating) *1		5.5 [7.5]	7.5 [10]	11 [15]	15 [20]	18.5 [25]	22 [30]
Output ratings	Rated capacity (kVA) *2	9.5 [10]	13 [13]	18 [19]	23 [24]	29 [30]	34 [36]
	Rated voltage (V) *3	Three-phase 200 to 240 V (with AVR function)					
	Rated current (A) *4	25	33	47	60	76	90
	Overload capability	150%-1 min, 200%-0.5 s					
Input power	Voltage, frequency	Three-phase 200 to 240 V, 50/60 Hz					
	Allowable voltage/frequency	Voltage: +10 to -15% (Interphase voltage unbalance: 2% or less) *6, Frequency: +5 to -5%					
	Rated input current (w/o DCR) (A) *7	31.5	42.7	60.7	80.0	97.0	112
	(with DCR) (A)	21.1	28.8	42.2	57.6	71.0	84.4
Required capacity (with DCR) (kVA) *8	7.3	10	15	20	25	30	
Braking	Torque (%) *9	20%					
	DC braking	Braking starting frequency: 0.0 to 60.0 Hz, Braking time: 0.0 to 30.0 s, Braking level: 0 to 100%					
	Braking transistor	Built-in as standard					
	Minimum resistance value (Ω)	20	15	10	8.6	4	
	Braking resistor	Separately mounted option					
DC reactor (DCR)	Separately mounted option						
Applicable safety standards	IEC/EN61800-5-1: 2007						
Enclosure (IEC60529)	IP20, UL open type						
Cooling method	Fan cooling						
Weight / Mass (kg) [lbs]	5.0 [11]	5.0 [11]	8.0 [18]	9.0 [20]	9.5 [21]	10 [22]	

Note: A box (□) in the above table replaces GA, GB or C depending on the model.

- *1 Fuji 4-pole standard motor
- *2 Rated capacity is calculated assuming the rated output voltage as 220 V (230 V).
- *3 Output voltage cannot exceed the power supply voltage.
- *4 Setting the carrier frequency (F26) to the following value or above requires current derating.
HHD spec. of types FRN0030E2■-2□ to FRN0115E2■-2□: 10 kHz
If reduction is necessary, for details, refer to Figure 10.4-1 in Chapter 10 “10.4.2 Guideline for selecting inverter drive mode and capacity.”
- *6
$$\text{Voltage unbalance (\%)} = \frac{\text{Max. voltage (V)} - \text{Min. voltage (V)}}{\text{Three - phase average voltage (V)}} \times 67 \quad (\text{IEC 61800-3})$$

If the unbalance ratio is 2% to 3%, use an optional AC reactor (ACR).
- *7 This specification is an estimated value to be applied when the power supply capacity is 500 kVA (Inverter capacity × 10 when the capacity exceeds 50 kVA) and the power supply with %X = 5% is connected.
- *8 This specification applies when a DC reactor (DCR) is used.
- *9 Average braking torque for the motor running alone. It depends on the efficiency of the motor.

■ Standard-model, Three-phase 400 V (460 V) class series (HHD-mode: 0.4 kW to 3.7 kW)

Item		Specifications				
Type (FRN_ _ _ _E2S-4□)		0002	0004	0006	0007	0012
Nominal applied motor (kW) [HP] (Output rating) *1		0.4 [1/2]	0.75 [1]	1.5 [2]	2.2 [3]	3.7 [5]
Output ratings	Rated capacity (kVA) *2	1.1 [1.2]	1.9 [2.0]	3.2 [3.3]	4.2 [4.4]	6.9 [7.2]
	Rated voltage (V) *3	Three-phase 380 to 480 V (with AVR function)				
	Rated current (A) *4	1.5	2.5	4.2	5.5	9.0
	Overload capability	150%-1 min, 200%-0.5 s				
Input power	Voltage, frequency	Three-phase 380 to 480 V, 50/60 Hz				
	Allowable voltage/frequency	Voltage: +10 to -15% (Interphase voltage unbalance: 2% or less) *6, Frequency: +5 to -5%				
	Rated input current (w/o DCR) (A) *7	1.7	3.1	5.9	8.2	13.0
	(with DCR) (A)	0.85	1.6	3.0	4.4	7.3
Required capacity (with DCR) (kVA) *8	0.6	1.2	2.1	3.1	5.1	
Braking	Torque (%) *9	100%		70%	40%	
	DC braking	Braking starting frequency: 0.0 to 60.0 Hz, Braking time: 0.0 to 30.0 s, Braking level: 0 to 100%				
	Braking transistor	Built-in as standard				
	Minimum resistance value (Ω)	200		160	130	
	Braking resistor	Separately mounted option				
DC reactor (DCR)	Separately mounted option					
Applicable safety standards	IEC/EN61800-5-1: 2007					
Enclosure (IEC60529)	IP20, UL open type					
Cooling method	Fan cooling					
Weight / Mass (kg) [lbs]	1.2 [2.6]	1.5 [3.3]	1.5 [3.3]	1.6 [3.5]	1.9 [4.2]	

Note: A box (□) in the above table replaces GA, GB or C depending on the model.

*1 Fuji 4-pole standard motor

*2 Rated capacity is calculated assuming the rated output voltage as 440 V (460 V).

*3 Output voltage cannot exceed the power supply voltage.

*4 Setting the carrier frequency (F26) to the following value or above requires current derating.
HHD spec of type FRN0002E2■-4□ to FRN0012E2■-4□: 8 kHz,
HHD spec of type FRN0022E2■-4□ to FRN0168E2■-4□: 10 kHz,
HHD spec of type FRN0203E2■-4□ to FRN0590E2■-4□: 6 kHz,
If reduction is necessary, for details, refer to Figure 10.4-1 in Chapter 10 "10.4.2 Guideline for selecting inverter drive mode and capacity."

*6 Voltage unbalance (%) = $\frac{\text{Max. voltage (V)} - \text{Min. voltage (V)}}{\text{Three - phase average voltage (V)}} \times 67$ (IEC 61800-3)

If the unbalance ratio is 2% to 3%, use an optional AC reactor (ACR).

*7 This specification is an estimated value to be applied when the power supply capacity is 500 kVA (Inverter capacity × 10 when the capacity exceeds 50 kVA) and the power supply with %X = 5% is connected. When applying with motors of 75 kW (100 HP) or above, a DC reactor (DCR) should be used.

*8 This specification applies when a DC reactor (DCR) is used.

*9 Average braking torque for the motor running alone. It depends on the efficiency of the motor.

■ Standard-model, Three-phase 400 V (460 V) class series (HHD-mode: 5.5 kW to 37 kW)

Item		Specifications							
Type (FRN_ _ _ _E2S-4□)		0022	0029	0037	0044	0059	0072	0085	0105
Nominal applied motor (kW) [HP] (Output rating) *1		5.5 [7.5]	7.5 [10]	11 [15]	15 [20]	18.5 [25]	22 [30]	30 [40]	37 [50]
Output ratings	Rated capacity (kVA) *2	9.9 [10]	14 [14]	18 [19]	23 [24]	30 [31]	34 [36]	46 [48]	57 [60]
	Rated voltage (V) *3	Three-phase 380 to 480 V (with AVR function)							
	Rated current (A) *4	13	18	24	30	39	45	60	75
	Overload capability	150%-1 min, 200%-0.5 s							
Input power	Voltage, frequency	Three-phase 380 to 480 V, 50/60 Hz							
	Allowable voltage/frequency	Voltage: +10 to -15% (Interphase voltage unbalance: 2% or less) *6, Frequency: +5 to -5%							
	Rated input current (w/o DCR) (A) *7	17.3	23.2	33	43.8	52.3	60.6	77.9	94.3
	(with DCR) (A)	10.6	14.4	21.1	28.8	35.5	42.2	57.0	68.5
Required capacity (with DCR) (kVA) *8	7.3	10	15	20	25	29	39	47	
Braking	Torque (%) *9	20%					10% to 15%		
	DC braking	Braking starting frequency: 0.0 to 60.0 Hz, Braking time: 0.0 to 30.0 s, Braking level: 0 to 100%							
	Braking transistor	Built-in as standard							
	Minimum resistance value (Ω)	80	60	40	34.4	16	—		
	Braking resistor	Separately mounted option							
DC reactor (DCR)	Separately mounted option								
Applicable safety standards	IEC/EN61800-5-1: 2007								
Enclosure (IEC60529)	IP20, UL open type								
Cooling method	Fan cooling								
Weight / Mass (kg) [lbs]	5.0 [11]	5.0 [11]	8.0 [18]	9.0 [20]	9.5 [21]	10 [22]	25 [55]	26 [57]	

Note: A box (□) in the above table replaces GA, GB or C depending on the model.

- *1 Fuji 4-pole standard motor
- *2 Rated capacity is calculated assuming the rated output voltage as 440 V (460 V).
- *3 Output voltage cannot exceed the power supply voltage.
- *4 Setting the carrier frequency (F26) to the following value or above requires current derating.
HHD spec of type FRN0002E2■-4□ to FRN0012E2■-4□: 8 kHz,
HHD spec of type FRN0022E2■-4□ to FRN0168E2■-4□: 10 kHz,
HHD spec of type FRN0203E2■-4□ to FRN0590E2■-4□: 6 kHz,
If reduction is necessary, for details, refer to Figure 10.4-1 in Chapter 10 “10.4.2 Guideline for selecting inverter drive mode and capacity.”
- *6 Voltage unbalance (%) = $\frac{\text{Max. voltage (V)} - \text{Min. voltage (V)}}{\text{Three - phase average voltage (V)}} \times 67$ (IEC 61800-3)
If the unbalance ratio is 2% to 3%, use an optional AC reactor (ACR).
- *7 This specification is an estimated value to be applied when the power supply capacity is 500 kVA (Inverter capacity × 10 when the capacity exceeds 50 kVA) and the power supply with %X = 5% is connected. When applying with motors of 75 kW (100 HP) or above, a DC reactor (DCR) should be used.
- *8 This specification applies when a DC reactor (DCR) is used.
- *9 Average braking torque for the motor running alone. It depends on the efficiency of the motor.

■ Standard-model, Three-phase 400 V (460 V) class series (HHD-mode: 45 kW to 220 kW)

Item		Specifications								
Type (FRN_ _ _ _E2S-4□)		0139	0168	0203	0240	0290	0361	0415	0520	0590
Nominal applied motor (kW) [HP] (Output rating) *1		45 [60]	55 [75]	75 [100]	90 [125]	110 [150]	132 [200]	160 [250]	200 [300]	220 [350]
Output ratings	Rated capacity (kVA) *2	69 [73]	85 [89]	114 [120]	134 [140]	160 [167]	193 [202]	232 [242]	287 [300]	316 [331]
	Rated voltage (V) *3	Three-phase 380 to 480 V (with AVR function)								
	Rated current (A) *4	91	112	150	176	210	253	304	377	415
	Overload capability	150%-1 min, 200%-0.5 s								
Input power	Voltage, frequency	Three-phase 380 to 480 V, 50/60 Hz			Three-phase 380 to 440 V, 50 Hz Three-phase 380 to 480 V, 60 Hz *5					
	Allowable voltage/frequency	Voltage: +10 to -15% (Interphase voltage unbalance: 2% or less) *6, Frequency: +5 to -5%								
	Rated input current (w/o DCR) (A) *7	114	140	–	–	–	–	–	–	–
	(with DCR) (A)	83.2	102	138	164	201	238	286	357	390
	Required capacity (with DCR) (kVA) *8	58	71	96	114	140	165	199	248	271
Braking	Torque (%) *9	10% to 15%								
	DC braking	Braking starting frequency: 0.0 to 60.0 Hz, Braking time: 0.0 to 30.0 s, Braking level: 0 to 100%								
	Braking transistor	Separately mounted option								
	Minimum resistance value (Ω)									
	Braking resistor	Separately mounted option								
DC reactor (DCR)	Separately mounted option			Must be used. Separately mounted component. Depending on the shipping destination, not provided with the inverter package. *11						
Applicable safety standards	IEC/EN61800-5-1: 2007									
Enclosure (IEC60529)	IP00, UL open type									
Cooling method	Fan cooling									
Weight / Mass (kg) [lbs]	30 [66]	33 [73]	40 [88]	62 [137]	63 [139]	95 [209]	96 [212]	130 [287]	140 [309]	

Note: A box (□) in the above table replaces GA, GB or C depending on the model.

*1 Fuji 4-pole standard motor

*2 Rated capacity is calculated assuming the rated output voltage as 440 V (460 V).

*3 Output voltage cannot exceed the power supply voltage.

*4 Setting the carrier frequency (F26) to the following value or above requires current derating.

HHD spec of type FRN0022E2■-4□ to FRN0168E2■-4□: 10 kHz,

HHD spec of type FRN0203E2■-4□ to FRN0590E2■-4□: 6 kHz,

If reduction is necessary, for details, refer to Figure 10.4-1 in Chapter 10 “10.4.2 Guideline for selecting inverter drive mode and capacity.”

*5 Inverters of FRN0203E2■-4□ or above (400 V class series) are equipped with a power switching connector. Use the connector depending upon the applied voltage. For details, refer to Chapter 2 “2.2.7 Switching Connector.”

*6
$$\text{Voltage unbalance (\%)} = \frac{\text{Max. voltage (V)} - \text{Min. voltage (V)}}{\text{Three - phase average voltage (V)}} \times 67 \quad (\text{IEC 61800-3})$$

If the unbalance ratio is 2% to 3%, use an optional AC reactor (ACR).

*7 This specification is an estimated value to be applied when the power supply capacity is 500 kVA (Inverter capacity × 10 when the capacity exceeds 50 kVA) and the power supply with %X = 5% is connected. When applying with motors of 75 kW (100 HP) or above, a DC reactor (DCR) should be used.

*8 This specification applies when a DC reactor (DCR) is used.

*9 Average braking torque for the motor running alone. It depends on the efficiency of the motor.

*11 Please consult your Fuji Electric sales representative.

■ Standard-model, Single-phase 200 V (230 V) class series (HHD-mode: 0.1 kW to 2.2 kW)

Item		Specifications					
Type (FRN_ _ _ _E2S-7□)		0001	0002	0003	0005	0008	0011
Nominal applied motor (kW) [HP] (Output rating) *1		0.1 [1/8]	0.2 [1/4]	0.4 [1/2]	0.75 [1]	1.5 [2]	2.2 [3]
Output ratings	Rated capacity (kVA) *2	0.3 [0.3]	0.6 [0.6]	1.1 [1.2]	1.9 [2.0]	3.0 [3.2]	4.2 [4.4]
	Rated voltage (V) *3	Three-phase 200 to 240 V (with AVR function)					
	Rated current (A) *4	0.8	1.6	3.0	5.0	8.0	11
	Overload capability	150%-1 min, 200%-0.5 s					
Input power	Voltage, frequency	Single-phase 200 to 240 V, 50/ 60 Hz					
	Allowable voltage/frequency	Voltage: +10 to -10%, Frequency: +5 to -5%					
	Rated input current (w/o DCR) (A) *7	1.8	3.3	5.4	9.7	16.4	24.8
	(with DCR) (A)	1.1	2.0	3.5	6.4	11.6	17.5
Required capacity (with DCR) (kVA) *8	0.3	0.4	0.7	1.3	2.4	3.5	
Braking	Torque (%) *9	150%		100%		70%	40%
	DC braking	Braking starting frequency: 0.0 to 60.0 Hz, Braking time: 0.0 to 30.0 s, Braking level: 0 to 100%					
	Braking transistor	Built-in as standard					
	Minimum resistance value (Ω)	100				40	
	Braking resistor	Separately mounted option					
DC reactor (DCR)	Separately mounted option						
Applicable safety standards	IEC/EN61800-5-1: 2007						
Enclosure (IEC60529)	IP00, UL open type						
Cooling method	Natural cooling				Fan cooling		
Weight / Mass (kg) [lbs]	0.5 [1.1]	0.5 [1.1]	0.6 [1.3]	0.9 [2.0]	1.6 [3.5]	1.8 [4.0]	

Note: A box (□) in the above table replaces GA, GB or C depending on the model.

- *1 Fuji 4-pole standard motor
- *2 Rated capacity is calculated assuming the rated output voltage as 220 V (230 V).
- *3 Output voltage cannot exceed the power supply voltage.
- *4 Setting the carrier frequency (F26) to the following value or above requires current derating.
HHD spec of type FRN0001E2■-4□ to FRN0011E2■-4□: 8 kHz,
If reduction is necessary, for details, refer to Figure 10.4-1 in Chapter 10 "10.4.2 "Guideline for selecting inverter drive mode and capacity."
- *7 This specification is an estimated value to be applied when the power supply capacity is 500 kVA (Inverter capacity × 10 when the capacity exceeds 50 kVA) and the power supply with %X = 5% is connected.
- *8 This specification applies when a DC reactor (DCR) is used.
- *9 Average braking torque for the motor running alone. It depends on the efficiency of the motor.

12.2 EMC Filter Built-in Type

12.2.1 ND-mode inverters for general load

■ Three-phase 400 V (460 V) class series

Item	Specifications				
Type (FRN___E2E-4□)	0002	0004	0006	0007	0012
Nominal applied motor (kW) [HP] (Output rating) *1	0.75 [1]	1.5 [2]	2.2 [3]	3.0 [4]	5.5 [7.5]
EMC filter	Compliant with EMC Directives. Emission: Category C2. Immunity: 2nd Env. (EN61800-3:2004)				
Weight / Mass (kg) [lbs]	TBD	TBD	TBD	TBD	TBD

Item	Specifications							
Type (FRN___E2E-4□)	0022	0029	0037	0044	0059	0072	0085	0105
Nominal applied motor (kW) [HP] (Output rating) *1	11 [15]	15 [20]	18.5 [25]	22 [30]	30 [40]	37 [50]	45 [60]	55 [75]
EMC filter	Compliant with EMC Directives. Emission: Category C3. Immunity: 2nd Env. (EN61800-3:2004)							
Weight / Mass (kg) [lbs]	6.5 [14]	6.5 [14]	11.2 [25]	11.2 [25]	10.5 [23]	11.2 [24]	26 [57]	27 [60]

Item	Specifications									
Type (FRN___E2E-4□)	0139	0168	0203	0240	0290	0361	0415	0520	0590	
Nominal applied motor (kW) [HP] (Output rating) *1	75 [100]	90 [125]	110 [150]	132 [200]	160 [250]	200 [300]	220 [350]	280 [450]	315 [500]	
EMC filter	Compliant with EMC Directives. Emission: Category C3. Immunity: 2nd Env. (EN61800-3:2004)									
Weight / Mass (kg) [lbs]	31 [68]	33 [73]	40 [88]	62 [137]	63 [139]	95 [209]	96 [212]	130 [287]	140 [309]	

Note: A box (□) in the above table replaces GA or GB depending on the model.

*1 Fuji 4-pole standard motor

The specification other than the above items is the same as “12.1.1 ND-mode inverters for general load”.

12.2.2 HD-mode inverters for heavy duty load

■ Three-phase 400 V (460 V) class series

Item	Specifications				
Type (FRN___E2E-4□)	0002	0004	0006	0007	0012
Nominal applied motor (kW) [HP] (Output rating) *1	0.75 [1]	1.1 [1.5]	2.2 [3]	3.0 [4]	5.5 [7.5]
EMC filter	Compliant with EMC Directives. Emission: Category C2. Immunity: 2nd Env. (EN61800-3:2004)				
Weight / Mass (kg) [lbs]	TBD	TBD	TBD	TBD	TBD

Item	Specifications							
Type (FRN___E2E-4□)	0022	0029	0037	0044	0059	0072	0085	0105
Nominal applied motor (kW) [HP] (Output rating) *1	7.5 [10]	11 [15]	15 [20]	18.5 [25]	22 [30]	30 [40]	37 [50]	45 [60]
EMC filter	Compliant with EMC Directives. Emission: Category C3. Immunity: 2nd Env. (EN61800-3:2004)							
Weight / Mass (kg) [lbs]	6.5 [14]	6.5 [14]	11.2 [25]	11.2 [25]	10.5 [23]	11.2 [24]	26 [57]	27 [60]

Item	Specifications									
Type (FRN___E2E-4□)	0139	0168	0203	0240	0290	0361	0415	0520	0590	
Nominal applied motor (kW) [HP] (Output rating) *1	55 [75]	75 [100]	90 [125]	110 [150]	132 [200]	160 [250]	200 [300]	220 [350]	250 [400]	
EMC filter	Compliant with EMC Directives. Emission: Category C3. Immunity: 2nd Env. (EN61800-3:2004)									
Weight / Mass (kg) [lbs]	31 [68]	33 [73]	40 [88]	62 [137]	63 [139]	95 [209]	96 [212]	130 [287]	140 [309]	

Note: A box (□) in the above table replaces GA or GB depending on the model.

*1 Fuji 4-pole standard motor

The specification other than the above items is the same as “12.1.2 HD-mode inverters for heavy duty load”.

12.2.3 HND-mode inverters for general load

■ Three-phase 400 V (460 V) class series

Item	Specifications				
Type (FRN_ _ _ _E2E-4□)	0002	0004	0006	0007 *10	0012 *10
Nominal applied motor (kW) [HP] (Output rating) *1	0.75 [1]	1.1 [1.5]	2.2 [3]	3.0 [4]	5.5 [7.5]
EMC filter	Compliant with EMC Directives. Emission: Category C2. Immunity: 2nd Env. (EN61800-3:2004)				
Weight / Mass (kg) [lbs]	TBD	TBD	TBD	TBD	TBD

Item	Specifications							
Type (FRN_ _ _ _E2E-4□)	0022	0029	0037	0044	0059	0072	0085	0105
Nominal applied motor (kW) [HP] (Output rating) *1	7.5 [10]	11 [15]	15 [20]	18.5 [25]	22 [30]	30 [40]	37 [50]	45 [60]
EMC filter	Compliant with EMC Directives. Emission: Category C3. Immunity: 2nd Env. (EN61800-3:2004)							
Weight / Mass (kg) [lbs]	6.5 [14]	6.5 [14]	11.2 [25]	11.2 [25]	10.5 [23]	11.2 [24]	26 [57]	27 [60]

Item	Specifications									
Type (FRN_ _ _ _E2E-4□)	0139	0168	0203	0240	0290	0361	0415	0520	0590	
Nominal applied motor (kW) [HP] (Output rating) *1	55 [75]	75 [100]	90 [125]	110 [150]	132 [200]	160 [250]	200 [300]	220 [350]	280 [450]	
EMC filter	Compliant with EMC Directives. Emission: Category C3. Immunity: 2nd Env. (EN61800-3:2004)									
Weight / Mass (kg) [lbs]	31 [68]	33 [73]	40 [88]	62 [137]	63 [139]	95 [209]	96 [212]	130 [287]	140 [309]	

Note: A box (□) in the above table replaces GA or GB depending on the model.

*1 Fuji 4-pole standard motor

*10 Types FRN0007E2■-4□ and FRN0012E2■-4□ are ND spec; allowable ambient temperature 40°C (+104°F) or less. The rated output current is decreased 1% for every 1°C (1.8°F) when ambient temperature is +40°C (+104°F) or more.

The specification other than the above items is the same as “12.1.3 HND-mode inverters for general load”.

12.2.4 HHD-mode inverters for heavy duty load

■ Three-phase 400 V (460 V) class series

Item	Specifications				
Type (FRN_ _ _ _E2E-4□)	0002	0004	0006	0007	0012
Nominal applied motor (kW) [HP] (Output rating) *1	0.4 [1/2]	0.75 [1]	1.5 [2]	2.2 [3]	3.7 [5]
EMC filter	Compliant with EMC Directives. Emission: Category C2. Immunity: 2nd Env. (EN61800-3:2004)				
Weight / Mass (kg) [lbs]	TBD	TBD	TBD	TBD	TBD

Item	Specifications							
Type (FRN_ _ _ _E2E-4□)	0022	0029	0037	0044	0059	0072	0085	0105
Nominal applied motor (kW) [HP] (Output rating) *1	5.5 [7.5]	7.5 [10]	11 [15]	15 [20]	18.5 [25]	22 [30]	30 [40]	37 [50]
EMC filter	Compliant with EMC Directives. Emission: Category C3. Immunity: 2nd Env. (EN61800-3:2004)							
Weight / Mass (kg) [lbs]	6.5 [14]	6.5 [14]	11.2 [25]	11.2 [25]	10.5 [23]	11.2 [24]	26 [57]	27 [60]

Item	Specifications									
Type (FRN_ _ _ _E2E-4□)	0139	0168	0203	0240	0290	0361	0415	0520	0590	
Nominal applied motor (kW) [HP] (Output rating) *1	45 [60]	55 [75]	75 [100]	90 [125]	110 [150]	132 [200]	160 [250]	200 [300]	220 [350]	
EMC filter	Compliant with EMC Directives. Emission: Category C3. Immunity: 2nd Env. (EN61800-3:2004)									
Weight / Mass (kg) [lbs]	31 [68]	33 [73]	40 [88]	62 [137]	63 [139]	95 [209]	96 [212]	130 [287]	140 [309]	

■ Single-phase 200 V (230 V) class series

Item	Specifications					
Type (FRN_ _ _ _E2E-7□)	0001	0002	0003	0005	0008	0011
Nominal applied motor (kW) [HP] (Output rating) *1	0.1 [1/8]	0.2 [1/4]	0.4 [1/2]	0.75 [1]	1.5 [2]	2.2 [3]
EMC filter	Compliant with EMC Directives. Emission: Category C2. Immunity: 2nd Env. (EN61800-3:2004)					
Weight / Mass (kg) [lbs]	TBD	TBD	TBD	TBD	TBD	TBD

Note: A box (□) in the above table replaces GA or GB depending on the model.







*1 Fuji 4-pole standard motor

The specification other than the above items is the same as “12.1.4 HHD-mode inverters for heavy duty load”.

12.3 Common Specifications

Item		Explanation	Remarks	
Output	Setting range	Maximum frequency	HHD/HND/HD mode: 25 to 500 Hz variable (under V/f control, Magnetic pole position sensorless vector control) (Up to 200 Hz in case of under vector control with speed sensor) ND mode: 25 to 120 Hz (under any drive control)	IMPG-VC
		Base frequency	25 to 500 Hz variable (in conjunction with the maximum frequency)	
		Starting frequency	0.1 to 60.0 Hz variable (0.0 Hz under vector control with speed sensor)	IMPG-VC
		Carrier frequency	Three phase 200 V class series FRN0001E2■-2□ to FRN0010E2■-2□, FRN0030E2■-2□ to FRN0088E2■-2□: • 0.75 to 16 kHz variable (HHD/HND spec.) FRN0012E2■-2□ to FRN0020E2■-2□: • 0.75 to 16 kHz variable (HHD spec.) • 0.75 to 10 kHz variable (ND spec.) FRN0115E2■-2□: • 0.75 to 16 kHz variable (HHD spec.) • 0.75 to 10 kHz variable (HND spec.) Three phase 400 V class series FRN0002E2■-4□ to FRN0059E2■-4□: • 0.75 to 16 kHz variable (HHD/HND/HD spec.) • 0.75 to 10 kHz variable (ND spec.) FRN0072E2■-4□ to FRN0168E2■-4□: • 0.75 to 16 kHz variable (HHD spec.) • 0.75 to 10 kHz variable (HND/HD spec.) • 0.75 to 6 kHz variable (ND spec.) FRN0203E2■-4□ to FRN0590E2■-4□: • 0.75 to 10 kHz variable (HHD spec.) • 0.75 to 6 kHz variable (HND/HD/ND spec.) Single phase 200 V class series FRN0001E2■-7□ to FRN0011E2■-7□: • 0.75 to 16 kHz variable (HHD spec.) Note: The carrier frequency may automatically lower depending upon the ambient temperature or the output current to protect the inverter. (The automatic lowering function can be disabled.)	
		Output frequency accuracy (Stability)	• Analog setting: $\pm 0.2\%$ of maximum frequency (at $25 \pm 10^\circ\text{C}$) ($77 \pm 18^\circ\text{F}$) • Keypad setting: $\pm 0.01\%$ of maximum frequency (at -10 to $+50^\circ\text{C}$) ($14 \pm 22^\circ\text{F}$)	
		Frequency setting resolution	• Analog setting: 0.05% of maximum frequency • Keypad setting: 0.01 Hz (99.99 Hz or less), 0.1 Hz (100.0 to 500 Hz) • Link setting: 0.005% of maximum frequency or 0.01 Hz (fixed)	
		Speed control range	• 1: 1500 (Minimum speed : Nominal speed, 4P, 1 to 1500 r/min) • 1: 100 (Minimum speed : Nominal speed, 4P, 15 to 1500 r/min) • 1: 10 (Minimum speed : Nominal speed, 6P, 180 to 1800 r/min)	IMPG-VC IMPG-VF PM-SVC
Speed control accuracy	• Analog setting: $\pm 0.2\%$ of maximum frequency or below (at $25 \pm 10^\circ\text{C}$) ($77 \pm 18^\circ\text{F}$) • Digital setting: $\pm 0.01\%$ of maximum frequency or below (at -10 to $+50^\circ\text{C}$) (14 to 122°F)	IMPG-VC		
	• Analog setting: $\pm 0.5\%$ of base frequency or below (at $25 \pm 10^\circ\text{C}$) ($77 \pm 18^\circ\text{F}$) • Digital setting: $\pm 0.5\%$ of base frequency or below (-10 to $+50^\circ\text{C}$) (14 to 122°F)	PM-SVC		
Control method	• V/f control • Vector control without speed sensor (Dynamic torque vector) • V/f control, with slip compensation • V/f control, with slip sensor (PG option) • V/f Control with speed sensor (+Auto Torque Boost)(PG option) • Vector control with speed sensor (PG option) • Vector control without magnetic pole position sensor	VF IM-SVC VF with SC IMPG-VF IMPG-ATB IMPG-VC PM-SVC		

12.3 Common Specifications

Item	Explanation	Remarks
Control method	<ul style="list-style-type: none"> • V/f control • Vector control without speed sensor (Dynamic torque vector) • V/f control, with slip compensation • V/f control, with slip sensor (PG option) • V/f Control with speed sensor (+Auto Torque Boost)(PG option) • Vector control with speed sensor (PG option) • Vector control without magnetic pole position sensor 	VF IM-SVC VF with SC IMPG-VF IMPG-ATB IMPG-VC PM-SVC
Voltage/frequency characteristics	<ul style="list-style-type: none"> • Possible to set 80 to 240 V / 160 to 500 V at base frequency and at maximum output frequency. • Non-linear V/f setting (3 points): Free voltage (0 to 240 V / 500 V) and frequency (0 to 500 Hz) can be set. 	
Torque boost	<ul style="list-style-type: none"> • Auto torque boost (For constant torque load) • Manual torque boost: Torque boost value can be set between 0.0 and 20.0% • Select application load with the function code. (Variable torque load or constant torque load) 	
Starting torque	Three phase 400 V class series <ul style="list-style-type: none"> • 200% or above, reference frequency 0.5 Hz (HHD-mode inverters of FRN0072E2■-4□ or below) 150% or above, reference frequency 0.5 Hz (HHD-mode inverters of FRN0085E2■-4□ or above) • 120% or above, reference frequency 0.5 Hz (HND/ND mode) • 150% or above, reference frequency 0.5 Hz (HD mode) Three phase 200 V class series <ul style="list-style-type: none"> • 200% or above, reference frequency 0.5 Hz (HHD-mode inverters of FRN0069E2■-2□ or below) • 120% or above, reference frequency 0.5 Hz (HND-mode inverters of FRN0069E2■-2□ or below) Single phase 200 V class series <ul style="list-style-type: none"> • 200% or above, reference frequency 0.5 Hz (HHD-mode inverters of FRN0011E2■-7□ or below) Base frequency 50 Hz, with slip compensation and auto torque boost active	
Start/stop operation	Keypad: Start and stop with  and  keys (Standard keypad) Start and stop with  /  and  keys (Optional multi-function keypad)	
	External signals (digital inputs): Forward (Reverse) rotation, stop command (capable of 3-wire operation), coast-to-stop command, external alarm, alarm reset, etc.	
	Link operation: Operation through RS-485 (built-in as standard), CANopen (built-in as standard) or field bus (option) communications link	
	Switching run command: Remote/local switching, link switching	
Frequency setting	Keypad: Using  and  keys External potentiometer: Using external frequency command potentiometer. (External resistor of 1 to 5 kΩ 1/2 W)	
	Analog input: 0 to ±10 VDC (±5 VDC)/ 0 to ±100% (terminal [12]), 0 to +10 VDC (+5 VDC)/ 0 to +100% (terminal [12]) 4 to 20 mADC/ 0 to +100% (terminal [C1] (C1 function)) 4 to 20 mADC/ 0 to ±100% (terminal [C1] (C1 function)) 0 to 20 mADC/ 0 to +100% (terminal [C1] (C1 function)) 0 to 20 mADC/ 0 to ±100% (terminal [C1] (C1 function)) 0 to +10 VDC (+5 VDC)/ 0 to +100% (terminal [C1] (V2 function)), 0 to +10 VDC (+5 VDC)/ 0 to ±100% (terminal [C1] (V2 function))	
	UP/DOWN operation: Frequency can be increased or decreased while the digital input signal is ON.	
	Multistep frequency: Selectable from 16 different frequencies (step 0 to 15)	
	Pattern operation: The inverter runs automatically according to the previously specified run time, rotation direction, acceleration/deceleration time and reference frequency. Up to 7 stages can be specified.	
	Link operation: Operation through RS-485 (built-in as standard), CANopen (built-in as standard) or field bus (option) communications link	
	Frequency setting: Two types of frequency settings can be switched with an external signal (digital input). Remote/local switching, link switching	

Item	Explanation	Remarks
Frequency setting	Auxiliary frequency setting: Inputs at terminal [12], [C1] (C1 function) or [C1] (V2 function) can be added to the main setting as auxiliary frequency settings.	
	Operation at a specified ratio: The ratio can be set by analog input signal. 0 to 10 VDC/0 (4) to 20 mA/0 to 200% (variable)	
	Inverse operation: Switchable from "0 to +10 VDC/0 to 100%" to "+10 to 0 VDC/0 to 100%" for the external command (terminals [12] and [C1] (V2 function)) Switchable from "0 to -10 VDC/0 to -100%" to "-10 to 0 VDC/0 to -100%" for the external command (terminal [12]) Switchable from "4 to +20 mA DC/0 to 100%" to "20 to 4 mA DC/0 to 100%" for the external command (terminal [C1] (C1 function)) Switchable from "0 to +20 mA DC/0 to 100%" to "20 to 0 mA DC/0 to 100%" for the external command (terminal [C1] (C1 function))	
	Pulse train input (standard): Pulse input = Terminal [X5], Rotational direction = general terminal Complementary output: Max. 100 kHz, Open collector output: Max. 30 kHz	
	Pulse train input (option): A PG option card is required. CW/CCW pulse, pulse + rotational direction Complementary output: Max. 100 kHz, Open collector output: Max. 30 kHz	
Acceleration/ deceleration time	Setting range: Between 0.00 and 6000 s	
	Switching: The four types of acceleration/deceleration time can be set or selected individually (switchable during operation).	
	Acceleration/deceleration pattern: Linear acceleration/deceleration, S-curve acceleration/deceleration (weak, arbitrary (with function code)), curvilinear acceleration/deceleration	
	Deceleration mode (coast-to-stop): Shutoff of the run command lets the motor coast to a stop.	
	Acceleration/deceleration time exclusive to jogging (0.00 to 6000 s)	
	Forcible stop deceleration time: Deceleration stop by the forcible stop STOP . During forced stop operation, S-curve acceleration/deceleration is disabled.	
Frequency limiter (Upper limit and lower limit frequencies)	<ul style="list-style-type: none"> Specifies the upper and lower limits in Hz. "Continue to run" or "Decelerate to a stop" selectable when the reference frequency drops below the lower limit. 	
Frequency/PID command bias	<ul style="list-style-type: none"> Bias of reference frequency and PID command can be independently set (setting range: 0 to ±100%). 	
Analog input	<ul style="list-style-type: none"> Gain: Setting range from 0 to 200% Offset: Setting range from -5.0 to +5.0% Filter: Setting range from 0.00 s to 5.00 s Polarity selection (±/+) 	
Jump frequency	<ul style="list-style-type: none"> Three operation points and their common jump width (0 to 30.0 Hz) can be set. 	
Timed operation	The inverter drives the motor for the run time specified from the keypad and stops its output. (Single-cycle operation)	
Jogging operation	<ul style="list-style-type: none"> Operation with RUN key (standard keypad), FWD or REV key (multi-function keypad), or digital input signal FWD or REV (Exclusive acceleration/deceleration time setting, exclusive frequency setting) 	
Auto-restart after momentary power failure	<ul style="list-style-type: none"> Trip immediately: Trip immediately at the time of power failure. Trip after a recovery from power failure: Coast to a stop at the time of power failure and trip when the power is recovered. Trip after decelerate-to-stop: Deceleration stop at power failure, and trip after stoppage Continue to run: Operation is continued using the load inertia energy. Start at the frequency selected before momentary power failure: Coast-to-stop at power failure and start after power recovery at the frequency selected before momentary stop. Start at starting frequency: Coast-to-stop at power failure and start at the starting frequency after power recovery. Start at the frequency searched at the time of power recovery: Coast-to-stop at power failure, search for the idling motor speed, and restart the motor. 	

Control

12.3 Common Specifications

Item	Explanation	Remarks	
Hardware current limiter	Limits the current by hardware to prevent an overcurrent trip from being caused by fast load variation or momentary power failure, which cannot be covered by the software current limiter. This limiter can be canceled.		
Operation by commercial power supply	With commercial power selection commands (SW50 , SW60), the inverter outputs 50/60 Hz.		
Slip compensation	<ul style="list-style-type: none"> Compensates for decrease in speed according to the load Possible to set constants for the response of slip compensation. 		
Droop control	<ul style="list-style-type: none"> Decreases the speed according to the load torque. 		
Torque limiter	Control output torque so that output torque is preset limiting value or less. <ul style="list-style-type: none"> Switchable between 1st and 2nd torque limit values 		
Torque current limiter	<ul style="list-style-type: none"> Torque limit and Torque current limit are selectable. Torque limit by analog input. 	IMPG-VC PM-SVC	
Software current limiter	Automatically reduces the frequency so that the output current becomes lower than the preset operation level. This limiter can be canceled.		
Overload stop	If the detected torque or current exceeds the preset value, the inverter decelerates the motor to a stop or causes the motor to coast to a stop.		
Control	PID control	<ul style="list-style-type: none"> PID processor for process control/dancer control Normal operation/inverse operation PID command: Keypad, analog input (from terminals [12], [C1] (C1 function) and [C1] (V2 function)), multistep frequency (3 steps), RS-485 communication PID feedback value: Analog input (from terminals [12], [C1] (C1 function) and [C1] (V2 function)) Alarm output (absolute value alarm, deviation alarm) Low liquid level stop function (pressurized operation possible before low liquid level stop) Anti-reset wind-up function PID output limiter Integration reset/hold 	
	Auto search for idling motor speed	The inverter automatically searches for the idling motor speed and starts to drive it without stopping it. Motor parameters require tuning. (Offline tuning)	
	Automatic deceleration	<ul style="list-style-type: none"> If the DC link bus voltage or calculated torque exceeds the automatic deceleration level during deceleration, the inverter automatically prolongs the deceleration time to avoid overvoltage trip. (It is possible to select forcible deceleration actuated when the deceleration time becomes three times longer.) If the calculated torque exceeds automatic deceleration level during constant speed operation, the inverter avoids overvoltage trip by increasing the frequency. 	
	Deceleration characteristic (improved braking capacity)	The motor loss is increased during deceleration to reduce the regenerative energy in the inverter to avoid overvoltage trip.	
	Auto energy saving operation	Controls the output voltage to minimize the total sum of the motor loss and inverter loss.	
	Overload prevention control	If the surrounding temperature or IGBT junction temperature increases due to overload, the inverter lowers the output frequency to avoid overload.	
	Battery/UPS operation	Cancels the undervoltage protection so that the inverter under an undervoltage condition runs the motor with battery/UPS power.	
	Offline tuning	Tunes the motor while the motor is stopped or running, for setting up motor parameters.	
	Online tuning	Controls the motor speed variation caused by the motor temperature rise during running.	
	Cooling fan ON/OFF control	<ul style="list-style-type: none"> Detects inverter internal temperature and stops cooling fan when the temperature is low. Possible to output a fan control signal to an external device. 	
	1st to 2nd motor settings	<ul style="list-style-type: none"> Switchable between two motors <p>It is possible to set the base frequency, rated current, torque boost, and electronic thermal slip compensation as the data for 1st and 2nd motors.</p>	

Item	Explanation	Remarks
Universal DI	Transfers the status of an external digital signal connected with the general-purpose digital input terminal to the host controller.	
Universal DO	Outputs a digital command signal sent from the host controller to the general-purpose digital output terminal.	
Universal AO	Outputs an analog command signal sent from the host controller to the analog output terminal.	
Speed control	<ul style="list-style-type: none"> Notch filter for vibration control Selectable among the four set of the auto speed regulator (ASR) parameters. (a PG option card is required.) 	IMPG-VC PM-SVC
Line speed control	In a machine such as winder/unwinder, regulates the motor speed to keep the peripheral speed of the spool constant. (a PG option card is required.)	IMPG-VF
Positioning control with pulse counter	<p>The positioning control starts from the preset start point and counts the feedback pulses by means of PG card installed in the inverter.</p> <p>The motor can be automatically started decelerating to the creep speed at which the target position can be detected, so that the motor can stop near the position (a PG option card is required).</p>	Excluded IMPG-VC PM-SVC
Master-follower operation	Enables synchronous operation of two motors equipped with a pulse generator (PG). (a PG option card is required.)	
Pre-excitation	Excitation is carried out to create the motor flux before starting the motor. (a PG option card is required.)	IMPG-VC
Zero speed control	The motor speed is held to zero by forcibly zeroing the speed command. (a PG option card is required.)	IMPG-VC
Servo lock	Stops the motor and holds the motor in the stopped position.(a PG option card is required.)	IMPG-VC
DC braking	Applies DC current to the motor at the operation start time or at the time of inverter stop to generate braking torque.	
Mechanical brake control	<ul style="list-style-type: none"> Possible to output mechanical brake control signals with the brake ON/OFF timing adjusted by the output current, torque command, output frequency and timer. Mechanical brake application check input. 	
Torque control	<ul style="list-style-type: none"> Analog torque/torque current command input Speed limit function is provided to prevent the motor from becoming out of control. Torque bias (analog setting, digital setting) (The PG option card is required.)	IMPG-VC
Rotation direction control	Select either of reverse or forward rotation prevention.	
Customizable logic interface	<p>Possible to select or connect digital logic circuits or analog operation circuits with digital/analog I/O signals, configure a simple relay sequence, and operate it freely.</p> <ul style="list-style-type: none"> Logic circuits: (Digital) AND, OR, XOR, flip-flop, detection of rising and falling edges, various counters. (Analog) Addition, subtraction, multiplication, division, limiters, absolute values, sign inversion addition, comparison, maximum value selection, minimum value selection, average values, scale conversion. Multifunction time: On-delay timer, off-delay timer, pulse train output, etc. Setting range: 0.0 to 9990 s Input/output signals: Terminal input/output, inverter control functions Others: Available in 200 steps configured with 2 inputs and 1 output per step. 	
Functions for wiredrawing machines, hoists, and spinning frames	Customizable logic function enables dedicated functions for each application.	

Control

12.3 Common Specifications

Item	Explanation	Remarks
Display	Indicators	Detachable, 7-segment, 4-digit LED, 7 push-buttons (PRG/RESET, FUNC/DATA, UP, DOWN, RUN, STOP, and SHIFT), and 6 LED indicators (KEYPAD CONTROL, Hz, A, kW, X10, and RUN)
	Running/stopping	Speed monitor (reference frequency, output frequency, motor speed, load shaft speed, line speed, and speed indication with percent), output current (A), output voltage (V), calculated torque (%), input power (kW), PID command value, PID feedback amount, PID output, timer values for timed operation (s), load factor (%), and motor output (kW), Torque current [%], Magnetic flux command [%], Analog input monitor, input watt-hour, constant feeding rate time (min.), and remaining time for timed operation (s) can be displayed.
	Maintenance monitor	DC link bus voltage, maximum effective current, input watt-hour, input watt-hour data, temperature (inverter internal temperature, maximum inverter internal temperature, heat sink temperature, maximum heat sink temperature), capacitance of the DC link bus capacitor, service life of DC link but capacitor (elapsed time/remaining time), cumulative run times (inverter power-ON time, electrolytic capacitors on printed circuit boards, cooling fans, individual motors), light-alarm contents (last four alarms), RS-485 error contents and number of error times, CANopen error contents, option error contents and number of error times, ROM version (inverter, keypad, and option)
	I/O check	Displays the I/O signal states of control circuit terminals using the segment ON/OFF of the 7-segment LED monitor or hexadecimal format. (digital and analog signals)
	Trip	Displays the cause of a trip by codes.
	Light-alarm	Shows the light-alarm display $\bar{L} - FL$.
	During running or at the time of a trip	<ul style="list-style-type: none"> • Trip history: Saves and displays the cause of the last four trips (with a code). • Saves and displays the detailed running status data of the last four trips.

*Note: The meaning of the described abbreviations are shown as follows.

VF V/f Control

IM-SVC(DTV) Speed Sensorless Vector control (Dynamic Torque Vector Control)

VF with SC V/f Control with Slip Compensation

IMPG-VF V/f Control with Speed Sensor (a PG option card is required.)

IMPG-ATB V/f Control with speed sensor (+Auto Torque Boost)(A PG option card is required.)

IMPG-VC Vector Control with Speed Sensor (a PG option card is required.)

PM-SVC Magnetic Pole Position Sensorless Vector Control

A box (■) in the above table replaces S or E depending on the enclosure.

When the protective function is activated so that the LED monitor shows alarm codes, refer to Chapter 6 "TROUBLESHOOTING."

For the usage environment and storage environment, refer to Chapter 1 "1.3 Precautions for Using Inverters."

Chapter 13

EXTERNAL DIMENSIONS

This chapter describes the external dimensions of the inverter.

Contents

13.1 Standard Model (FRN0069E2S-2□/ FRN0044E2S-4□/ FRN0011E2S-7□ or below)	13-1
13.2 Standard / EMC Filter Built-in Type (FRN0088E2■-2□/ FRN0059E2■-4□ or above)	13-6
13.3 EMC Filter Built-in Type (FRN0069E2E-2□/ FRN0044E2E-4□/ FRN0012E2E-7□ or below)	13-14
13.4 Keypad	13-17

13.1 Standard Model
(FRN0069E2S-2□/ FRN0044E2S-4□/ FRN0011E2S-7□ or below)

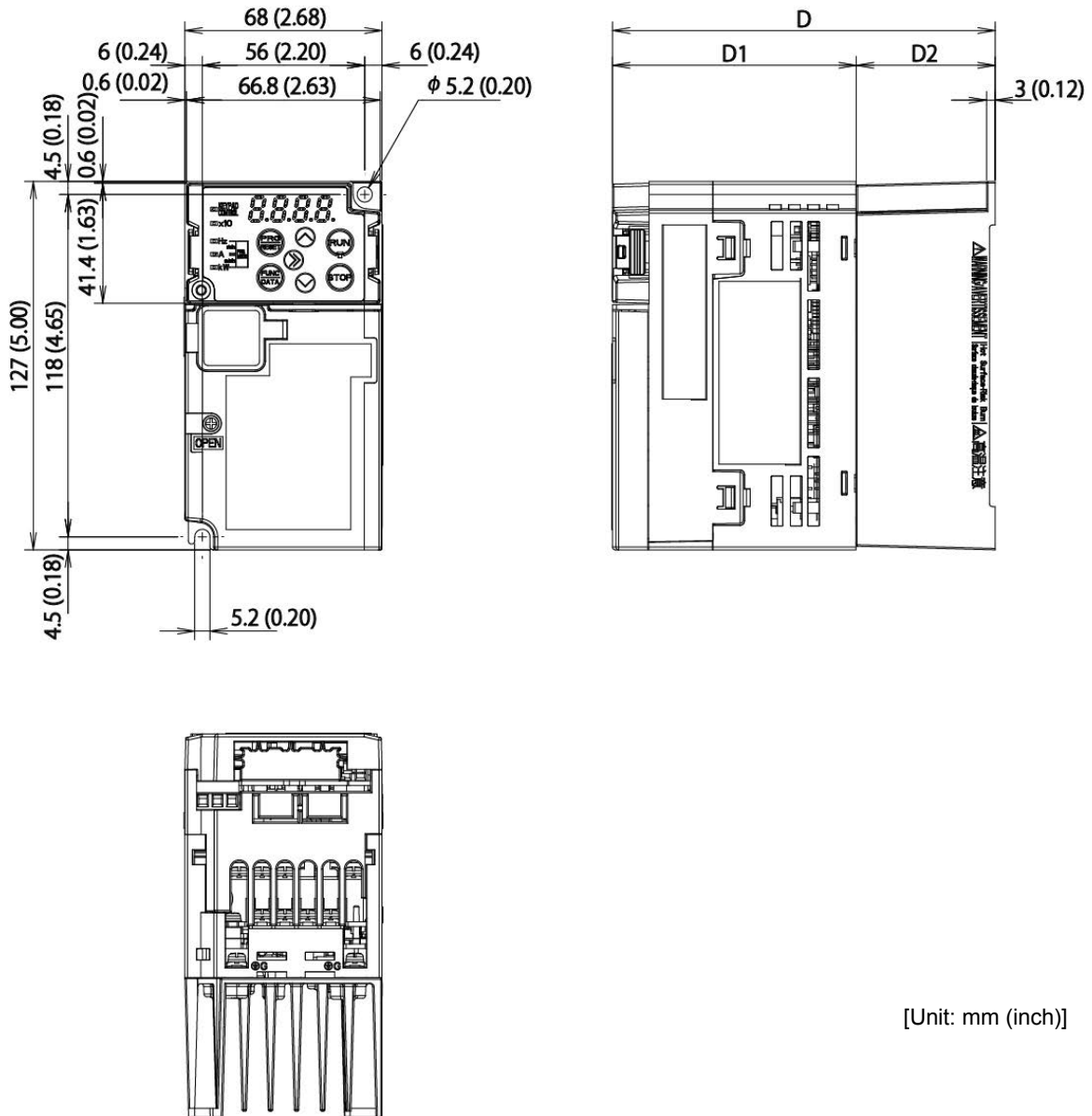

[Unit: mm (inch)]

Figure 13.1-1

Power supply voltage	Inverter type	Dimension [mm (inch)]		
		D	D1	D2
Three-phase 200V	FRN0001E2S-2□	85 (3.35)	77 (3.03)	8 (0.31)
	FRN0002E2S-2□	85 (3.35)	77 (3.03)	8 (0.31)
	FRN0004E2S-2□	100 (3.94)	77 (3.03)	23 (0.91)
	FRN0006E2S-2□	132 (5.20)	84 (3.31)	48 (1.89)
Single-phase 200V	FRN0001E2S-7□	85 (3.35)	77 (3.03)	8 (0.31)
	FRN0002E2S-7□	85 (3.35)	77 (3.03)	8 (0.31)
	FRN0003E2S-7□	107 (4.21)	84 (3.31)	23 (0.91)
	FRN0005E2S-7□	152 (5.98)	104 (4.09)	48 (1.89)

A box (□) in the above table replaces GA, GB or C depending on the model.

13.1 Standard Model
(FRN0069E2S-2□/ FRN0044E2S-4□/ FRN0011E2S-7□ or below)

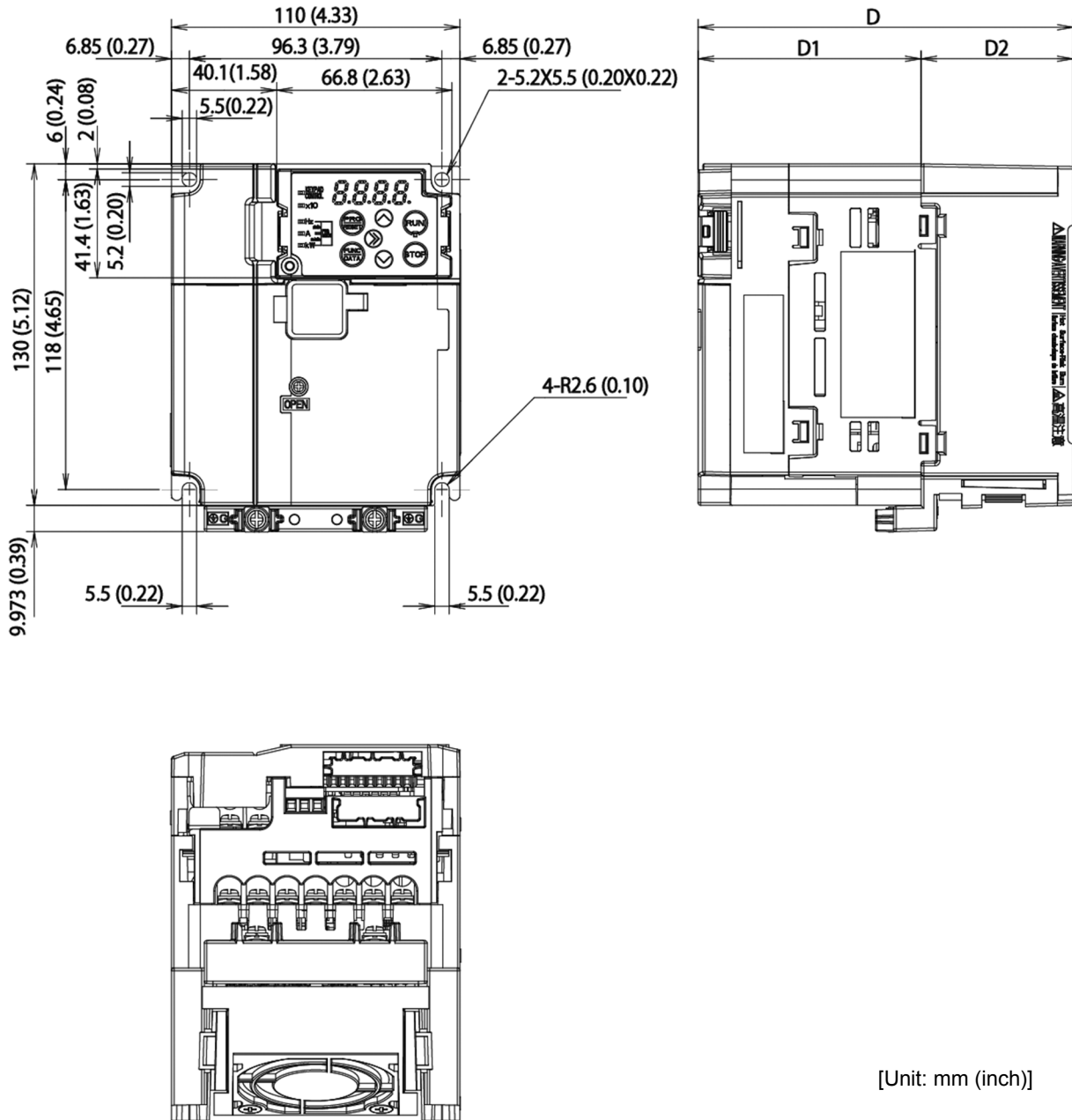

[Unit: mm (inch)]

Figure 13.1-2

Power supply voltage	Inverter type	Dimension [mm (inch)]		
		D	D1	D2
Three-phase 200V	FRN0010E2S-2□	143 (5.63)	85 (3.35)	58 (2.28)
	FRN0012E2S-2□	143 (5.63)	85 (3.35)	58 (2.28)
Three-phase 400V	FRN0002E2S-4□	119 (4.69)	85 (3.35)	34 (1.34)
	FRN0004E2S-4□	143 (5.63)	85 (3.35)	58 (2.28)
	FRN0006E2S-4□	143 (5.63)	85 (3.35)	58 (2.28)
	FRN0007E2S-4□	143 (5.63)	85 (3.35)	58 (2.28)
Single-phase 200V	FRN0008E2S-7□	153 (6.02)	95 (3.74)	58 (2.28)

A box (□) in the above table replaces GA, GB or C depending on the model.

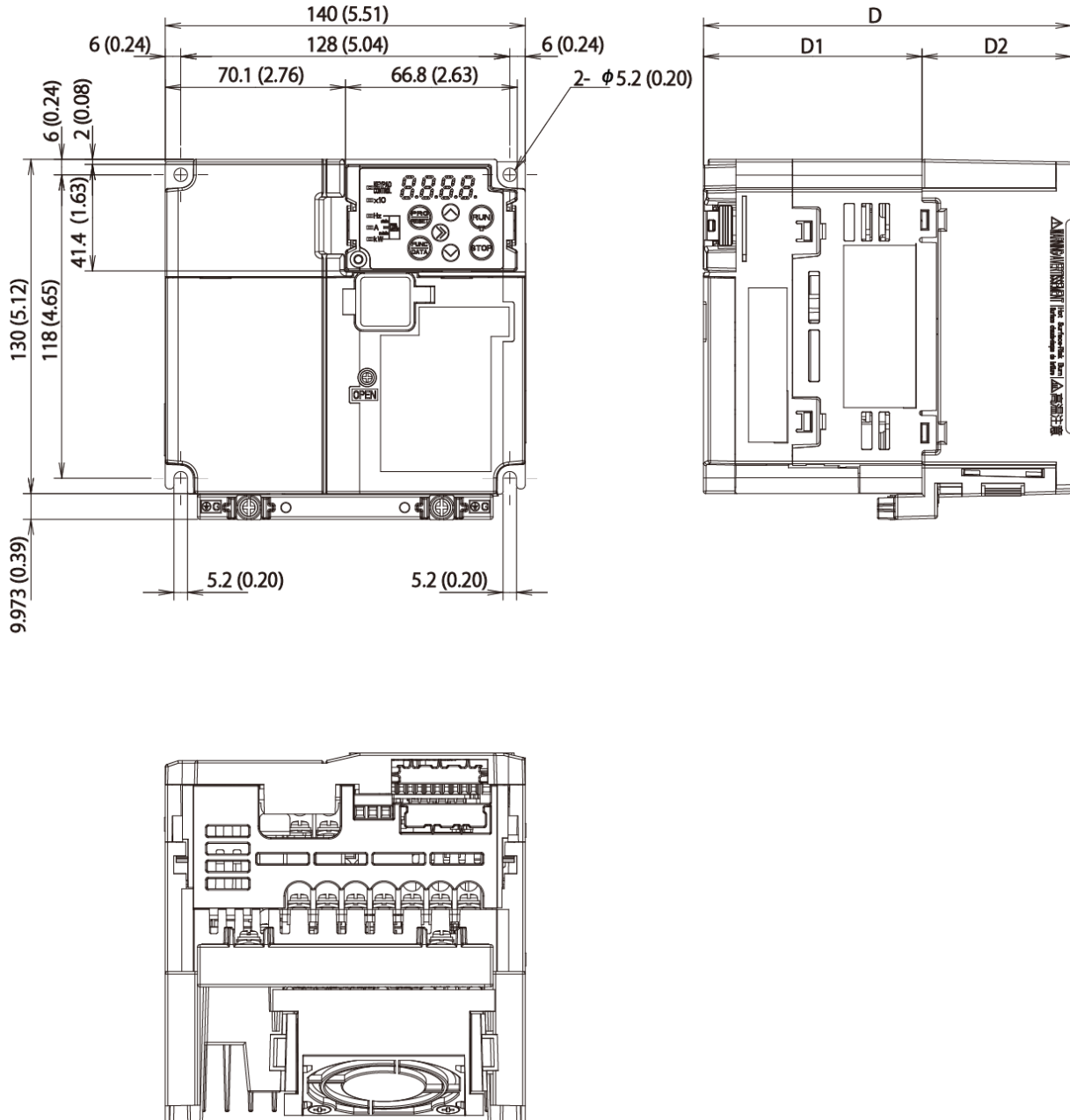

Figure 13.1-3

Power supply voltage	Inverter type	Dimension [mm (inch)]		
		D	D1	D2
Three-phase 200V	FRN0020E2S-2□	143 (5.63)	85 (3.35)	58 (2.28)
Three-phase 400V	FRN0012E2S-4□	143 (5.63)	85 (3.35)	58 (2.28)
Single-phase 200V	FRN0011E2S-7□	143 (5.63)	85 (3.35)	58 (2.28)

A box (□) in the above table replaces GA, GB or C depending on the model.

* The figure given in the lower right-hand corner of each set of drawings shows the dimension of panel cutting required for external cooling. To employ external cooling for inverters FRN0030E2S-2□ to FRN0115E2S-2□ and FRN0022E2S-4□ to FRN0072E2S-4□, the optional mounting adapter for external cooling is necessary. For the external dimensions of the mounting adapter, refer to Chapter 11, Section 11.15.

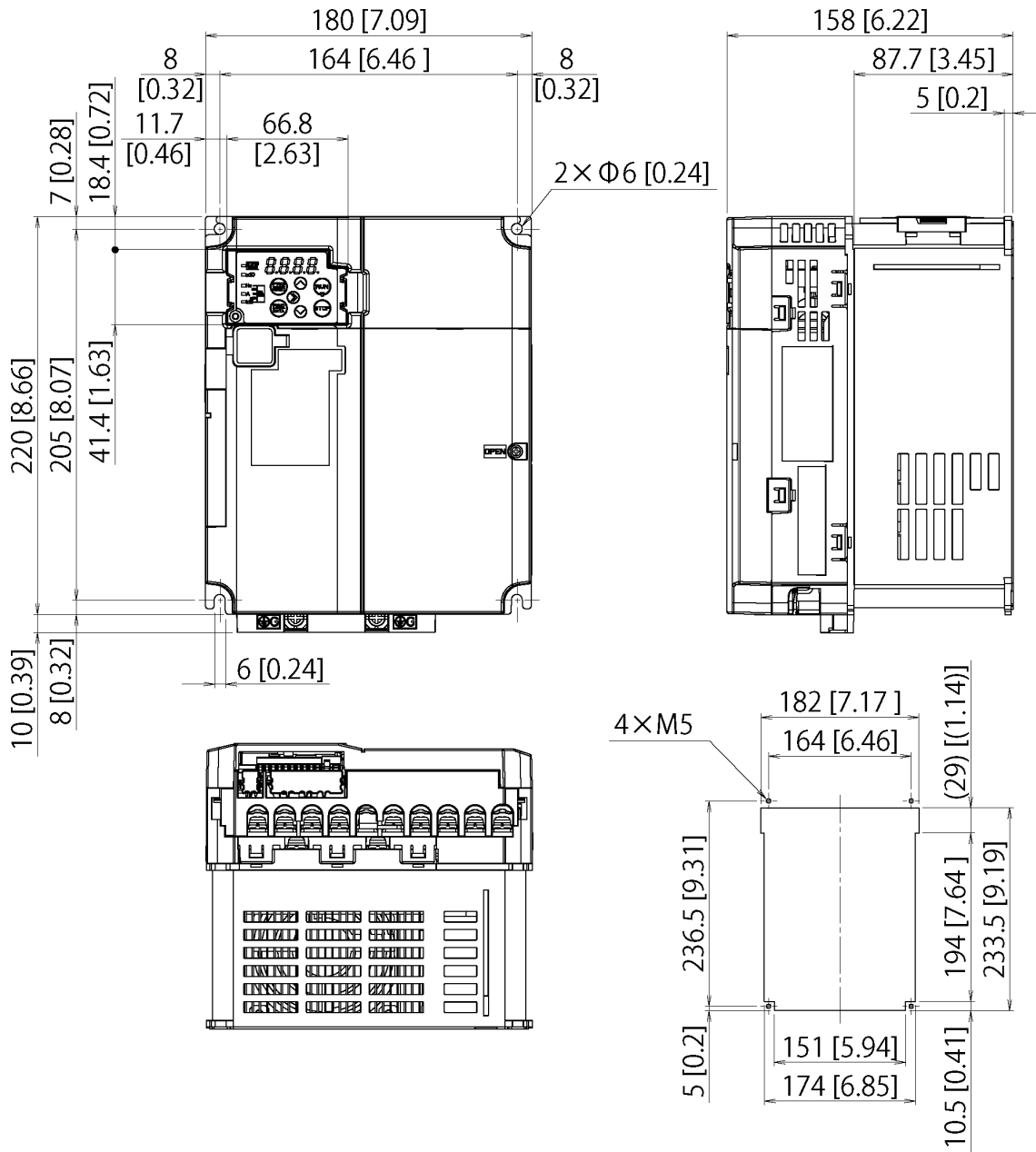

Figure 13.1-4

(Unit: mm [inch])

Power supply voltage	Inverter type
Three-phase 200V	FRN0030E2S-2□
	FRN0040E2S-2□
Three-phase 400V	FRN0022E2S-4□
	FRN0029E2S-4□

A box (□) in the above table replaces GA, GB or C depending on the model.

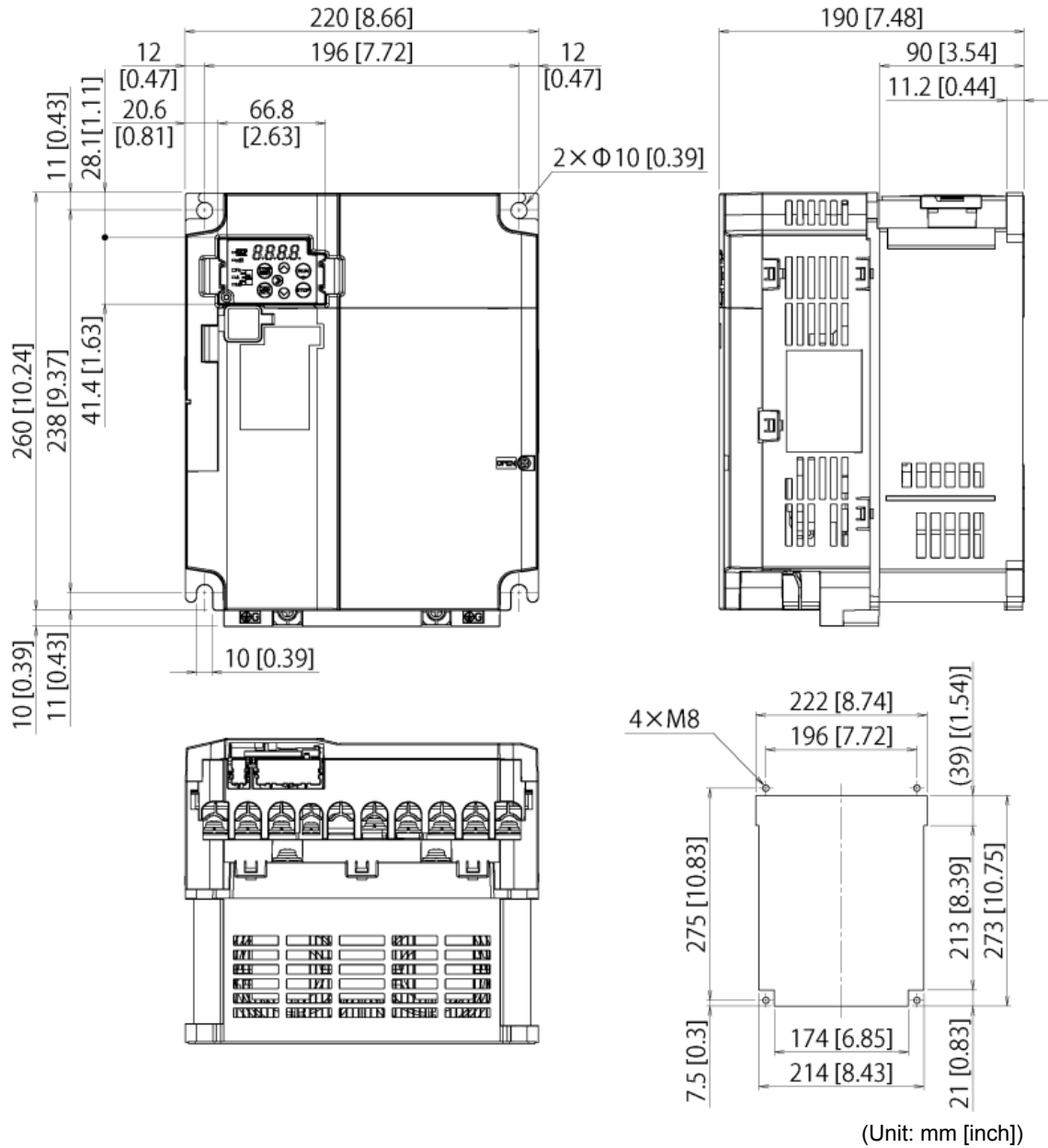

Figure 13.1-5

Power supply voltage	Inverter type
Three-phase 200V	FRN0056E2S-2□
	FRN0069E2S-2□
Three-phase 400V	FRN0037E2S-4□
	FRN0044E2S-4□

A box (□) in the above table replaces GA, GB or C depending on the model.

**13.2 Standard / EMC Filter Built-in Type
(FRN0088E2■-2□/ FRN0059E2■-4□ or above)**

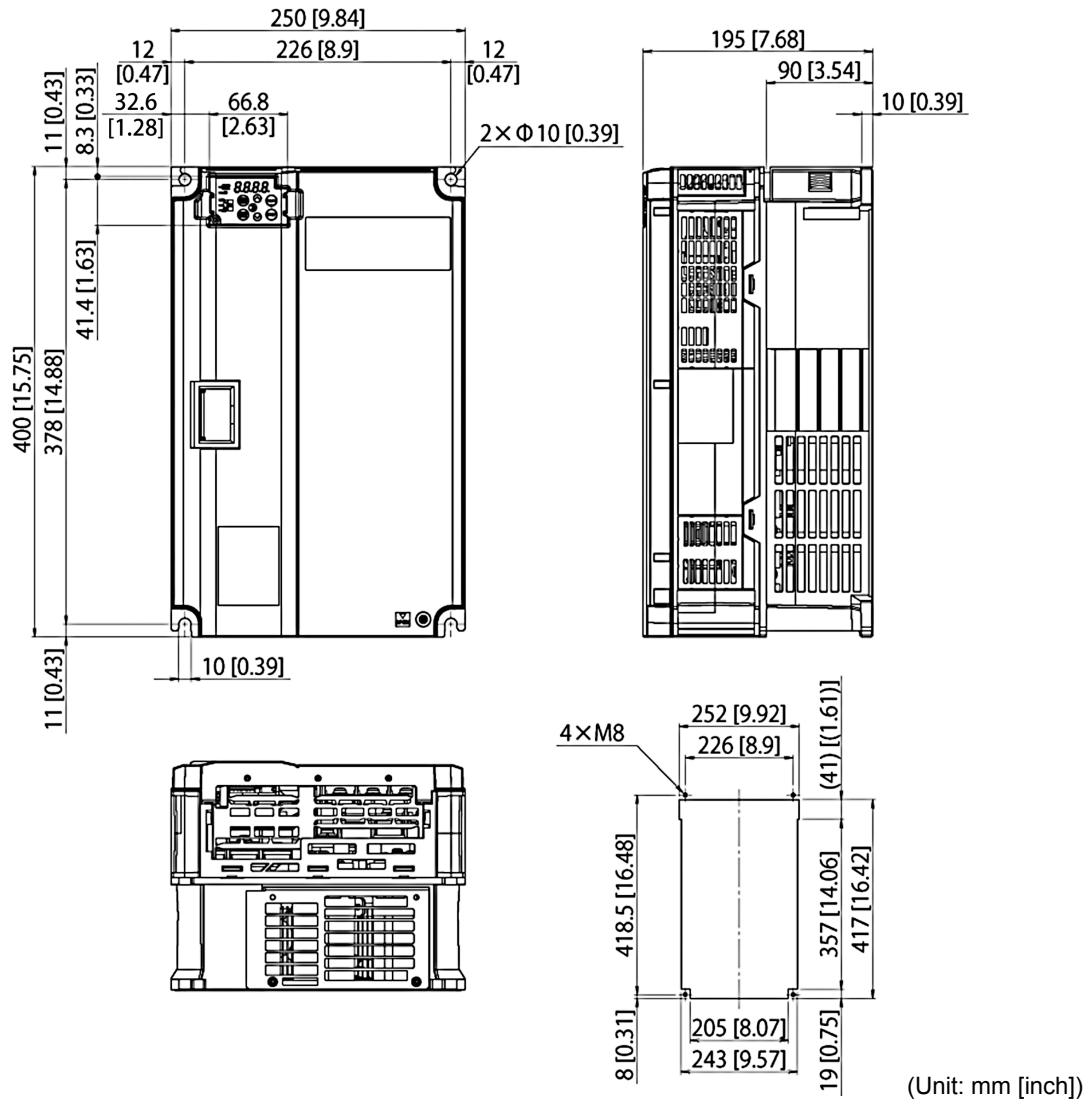

Figure 13.2-1

Power supply voltage	Model	Inverter type
Three-phase 200V	Standard model	FRN0088E2S-2□
		FRN0115E2S-2□
	EMC-filter built in type	FRN0088E2E-2□
		FRN0115E2E-2□
Three-phase 400V	Standard model	FRN0059E2S-4□
		FRN0072E2S-4□
	EMC-filter built in type	FRN0059E2E-4□
		FRN0072E2E-4□

A box (□) in the above table replaces GA, GB or C depending on the model.

13.2 Standard / EMC Filter Built-in Type
(FRN0088E2-2□/ FRN0059E2-4□ or above)

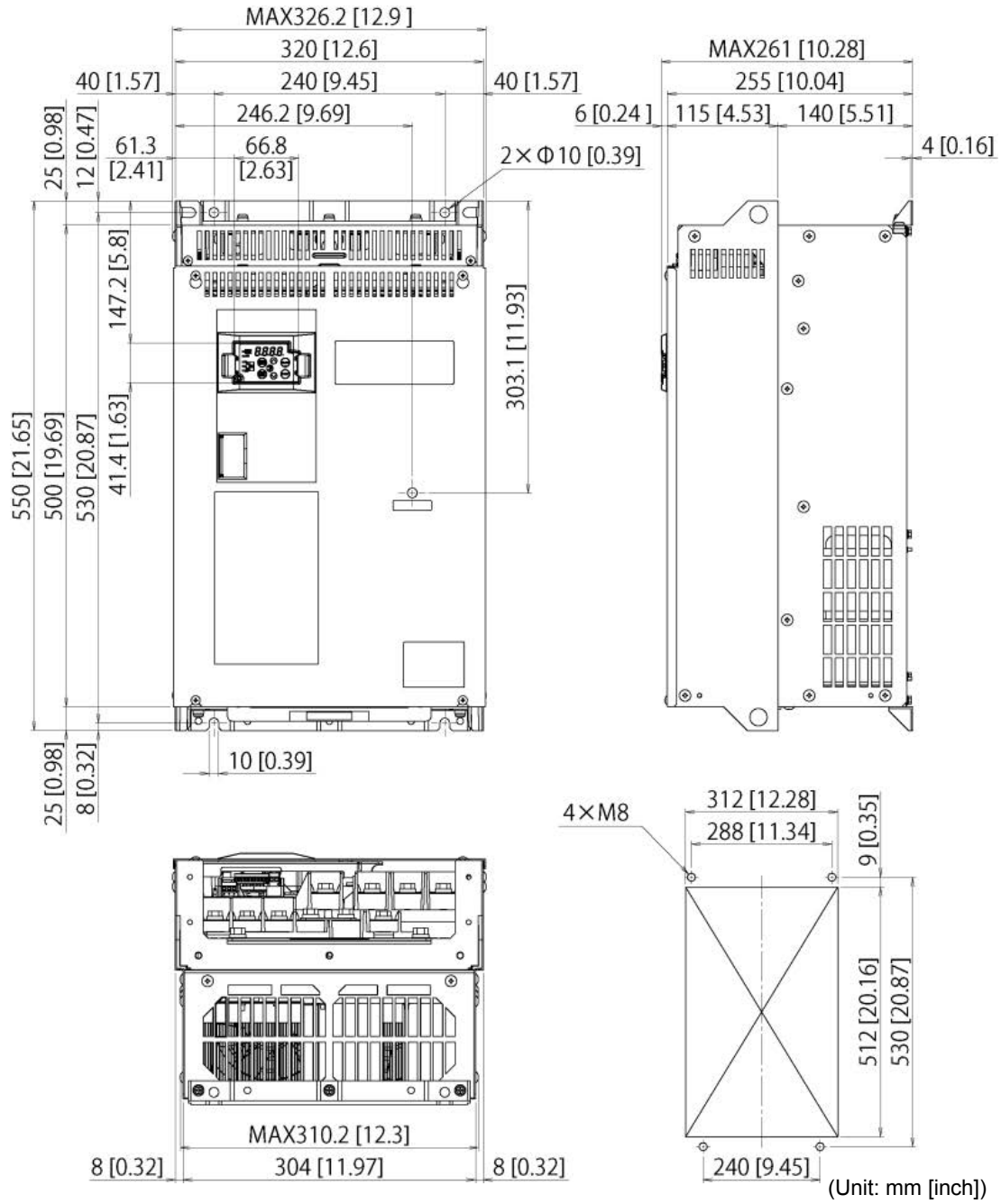

Figure 13.2-2

Power supply voltage	Model	Inverter type
Three-phase 400V	Standard model	FRN0085E2S-4□
		FRN0105E2S-4□
	EMC-filter built in type	FRN0085E2E-4□
		FRN0105E2E-4□

A box (□) in the above table replaces GA, GB or C depending on the model.

13.2 Standard / EMC Filter Built-in Type
(FRN0088E2-2□/ FRN0059E2-4□ or above)

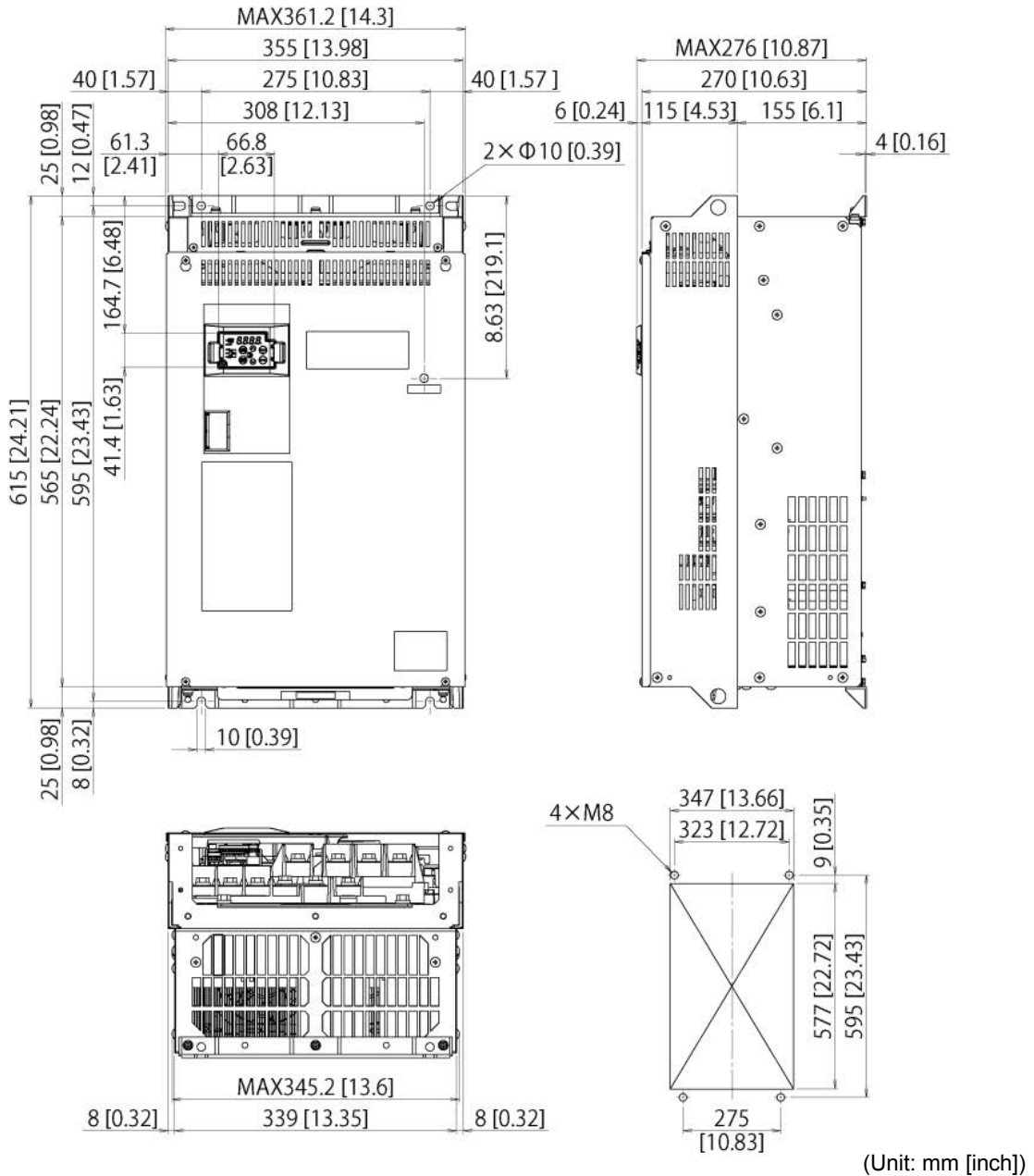

Figure 13.2-3

Power supply voltage	Model	Inverter type
Three-phase 400V	Standard model	FRN0139E2S-4□
	EMC-filter built in type	FRN0139E2E-4□

A box (□) in the above table replaces GA, GB or C depending on the model.

13.2 Standard / EMC Filter Built-in Type
(FRN0088E2-2□/ FRN0059E2-4□ or above)

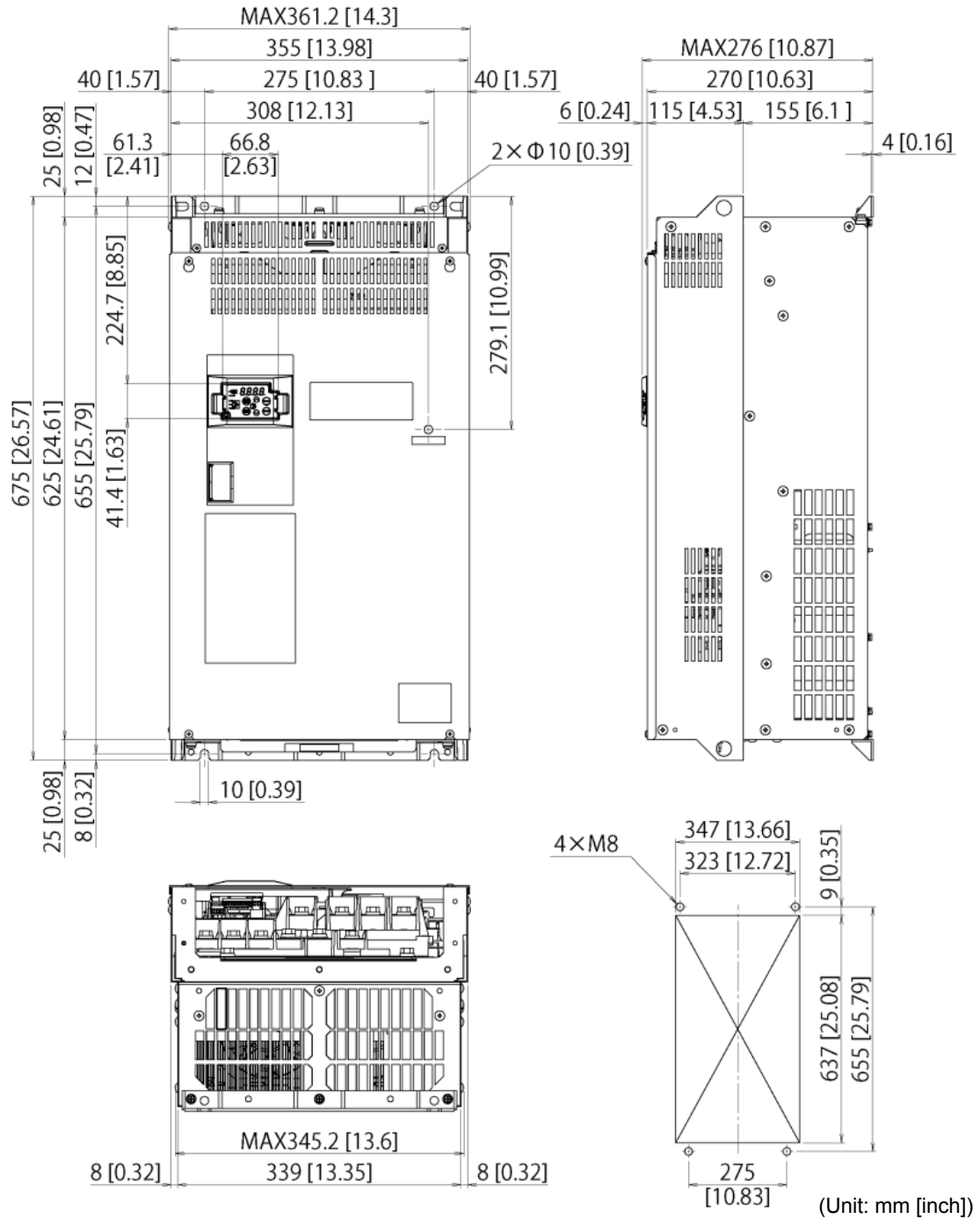

Figure 13.2-4

Power supply voltage	Model	Inverter type
Three-phase 400V	Standard model	FRN0168E2S-4□
	EMC-filter built in type	FRN0168E2E-4□

A box (□) in the above table replaces GA, GB or C depending on the model.

13.2 Standard / EMC Filter Built-in Type
(FRN0088E2-2□/ FRN0059E2-4□ or above)

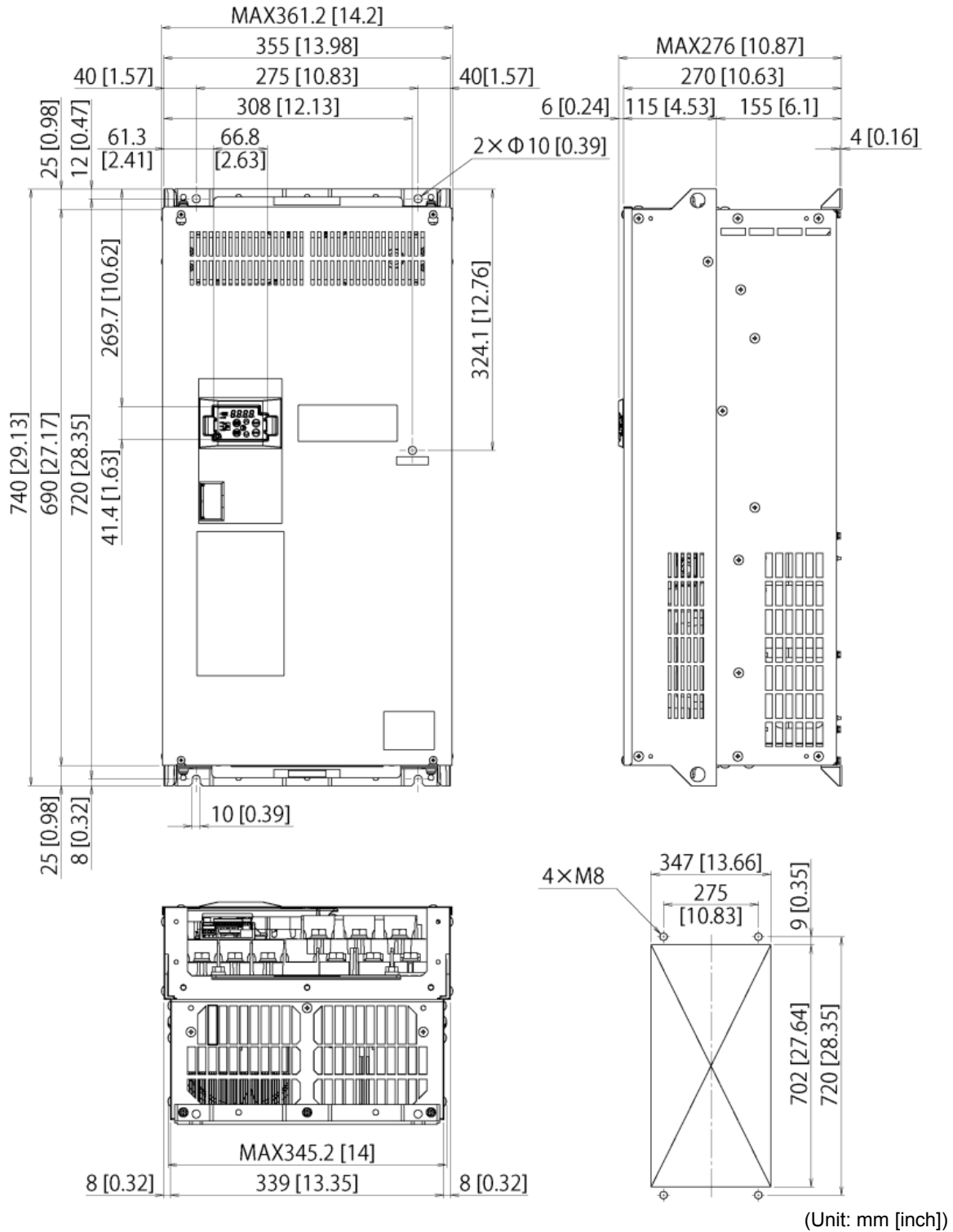

Figure 13.2-5

Power supply voltage	Model	Inverter type
Three-phase 400V	Standard model	FRN0203E2S-4□
	EMC-filter built in type	FRN0203E2E-4□

A box (□) in the above table replaces GA, GB or C depending on the model.

13.2 Standard / EMC Filter Built-in Type
(FRN0088E2-2□/ FRN0059E2-4□ or above)

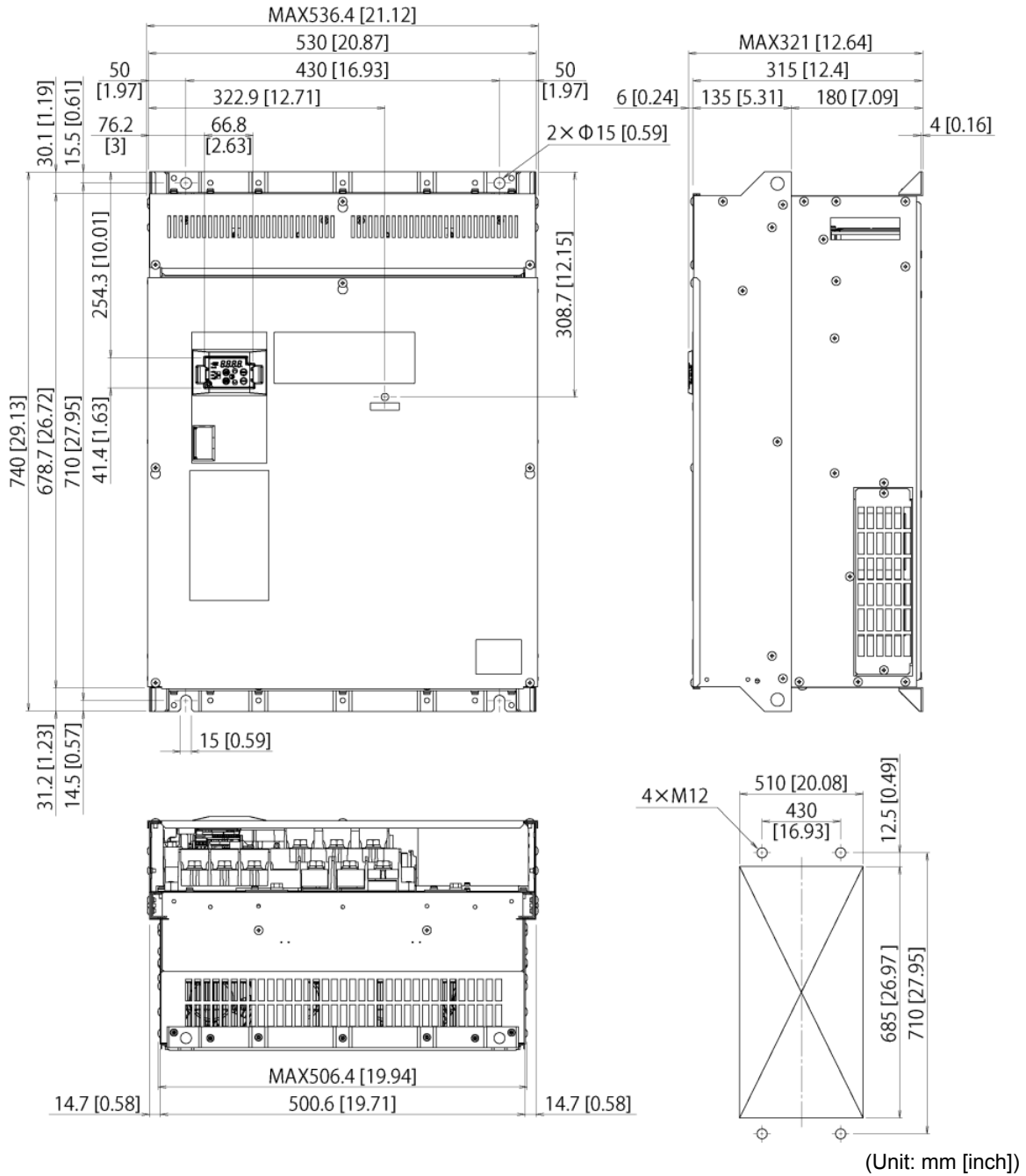

Figure 13.2-6

Power supply voltage	Model	Inverter type
Three-phase 400V	Standard model	FRN0240E2S-4□
		FRN0290E2S-4□
	EMC-filter built in type	FRN0240E2E-4□
		FRN0290E2E-4□

A box (□) in the above table replaces GA, GB or C depending on the model.

13.2 Standard / EMC Filter Built-in Type
(FRN0088E2-2□/ FRN0059E2-4□ or above)

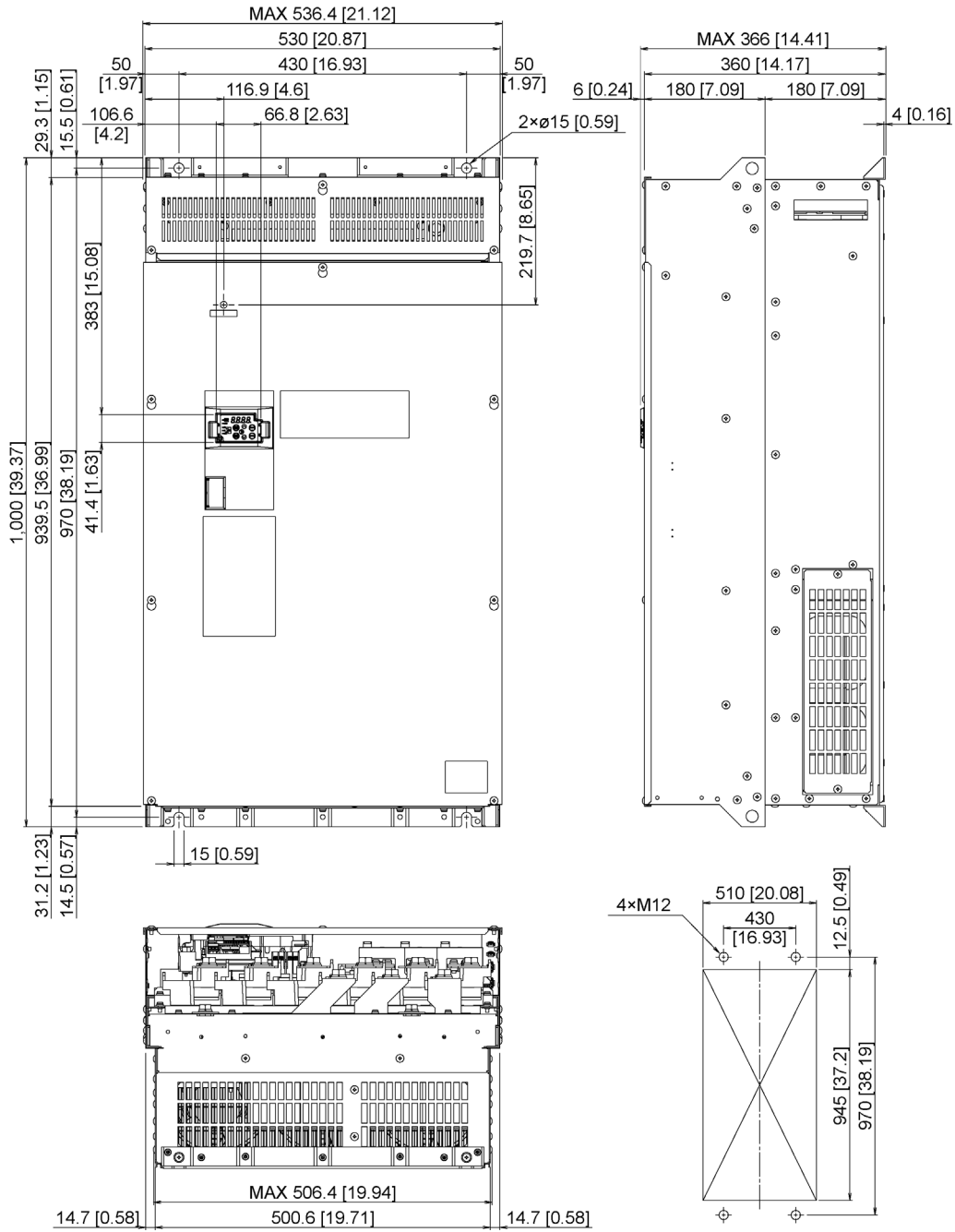

Figure 13.2-7

(Unit: mm [inch])

Power supply voltage	Model	Inverter type
Three-phase 400V	Standard model	FRN0361E2S-4□
		FRN0415E2S-4□
	EMC-filter built in type	FRN0361E2E-4□
		FRN0415E2E-4□

A box (□) in the above table replaces GA, GB or C depending on the model.

13.2 Standard / EMC Filter Built-in Type
(FRN0088E2-2□/ FRN0059E2-4□ or above)

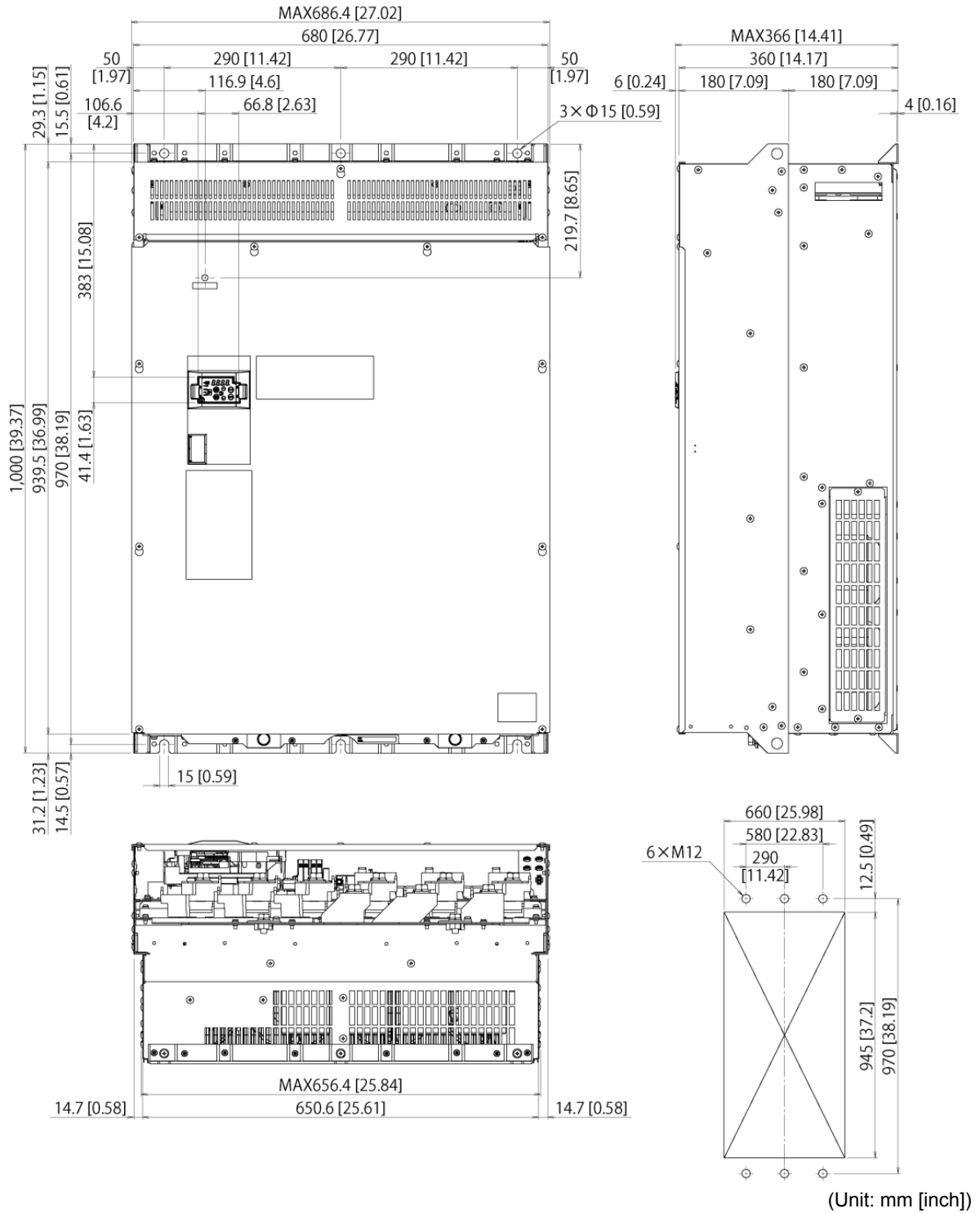

Figure 13.2-8

Power supply voltage	Model	Inverter type
Three-phase 400V	Standard model	FRN0520E2S-4□
		FRN0590E2S-4□
	EMC-filter built in type	FRN0520E2E-4□
		FRN0590E2E-4□

A box (□) in the above table replaces GA, GB or C depending on the model.

13.3 EMC Filter Built-in Type (FRN0069E2E-2□/ FRN0044E2E-4□/ FRN0012E2E-7□ or below)

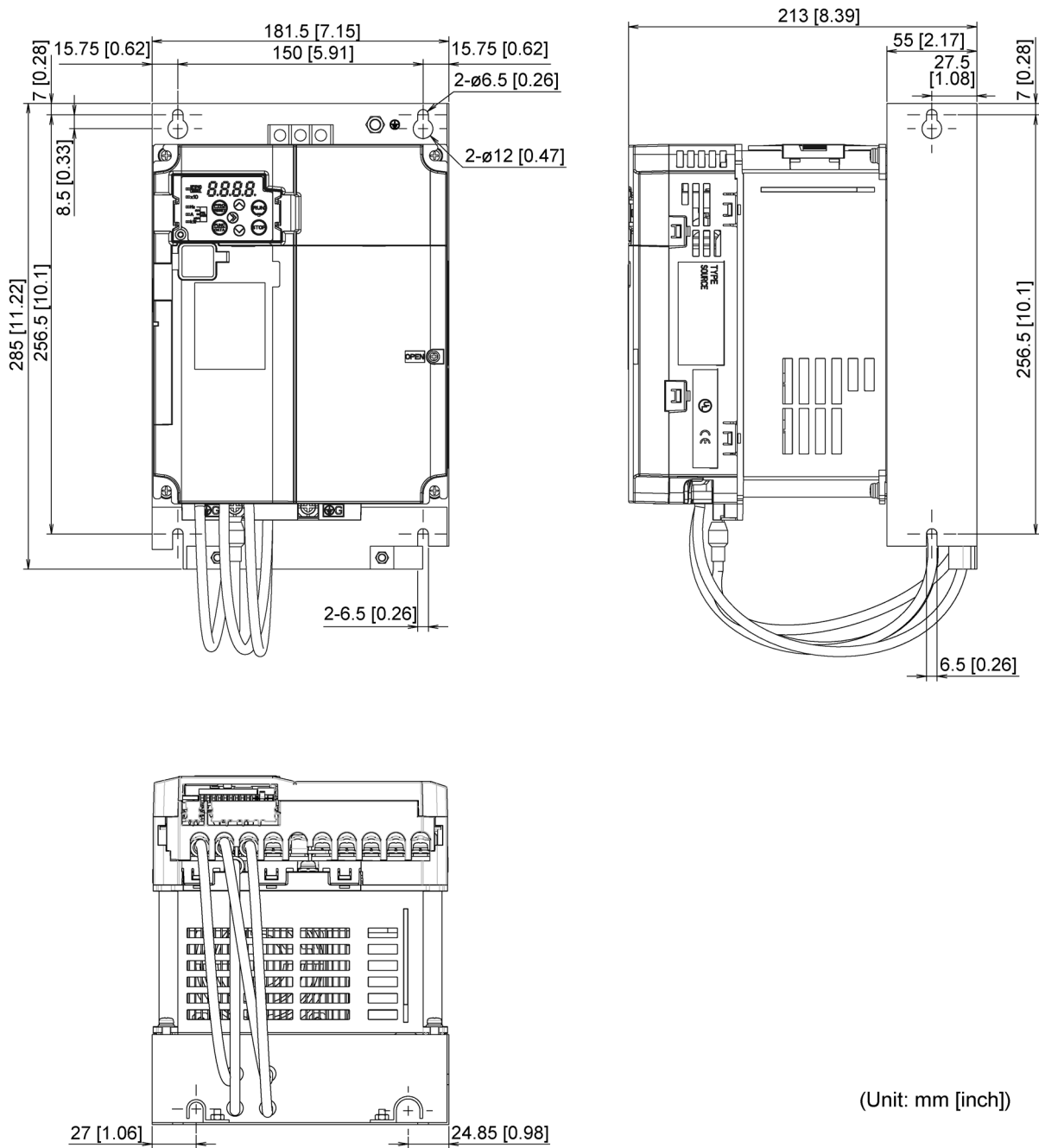

Figure 13.3-1

Power supply voltage	Inverter type
Three-phase 200V	FRN0030E2E-2□
	FRN0040E2E-2□
Three-phase 400V	FRN0022E2E-4□
	FRN0029E2E-4□

A box (□) in the above table replaces GA, GB or C depending on the model.

13.3 EMC Filter Built-in Type
(FRN0069E2E-2□/ FRN0044E2E-4□/ FRN0012E2E-7□ or below)

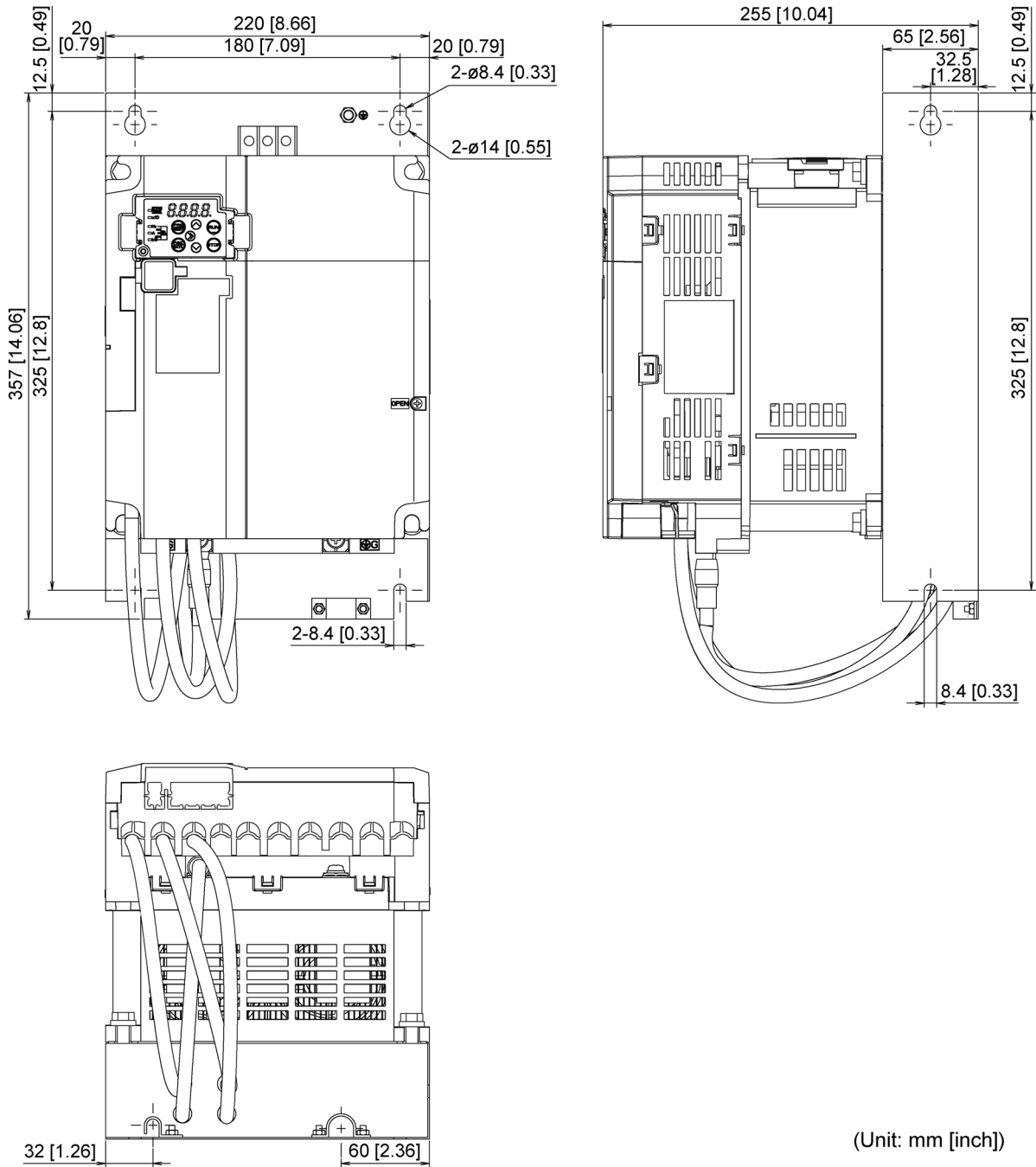

Figure 13.3-2

Power supply voltage	Inverter type
Three-phase 200V	FRN0056E2E-2□
	FRN0069E2E-2□
Three-phase 400V	FRN0037E2E-4□
	FRN0044E2E-4□

A box (□) in the above table replaces GA, GB or C depending on the model.

Please contact Fuji Electric for the following models dimensions.

- FRN0001E2E-2□
- FRN0002E2E-2□
- FRN0004E2E-2□
- FRN0006E2E-2□
- FRN0010E2E-2□
- FRN0012E2E-2□
- FRN0020E2E-2□
- FRN0002E2E-4□
- FRN0004E2E-4□
- FRN0006E2E-4□
- FRN0007E2E-4□
- FRN0012E2E-4□
- FRN0001E2E-7□
- FRN0002E2E-7□
- FRN0003E2E-7□
- FRN0005E2E-7□
- FRN0008E2E-7□
- FRN0011E2E-7□

13.4 Keypad

(Unit: mm [inch])

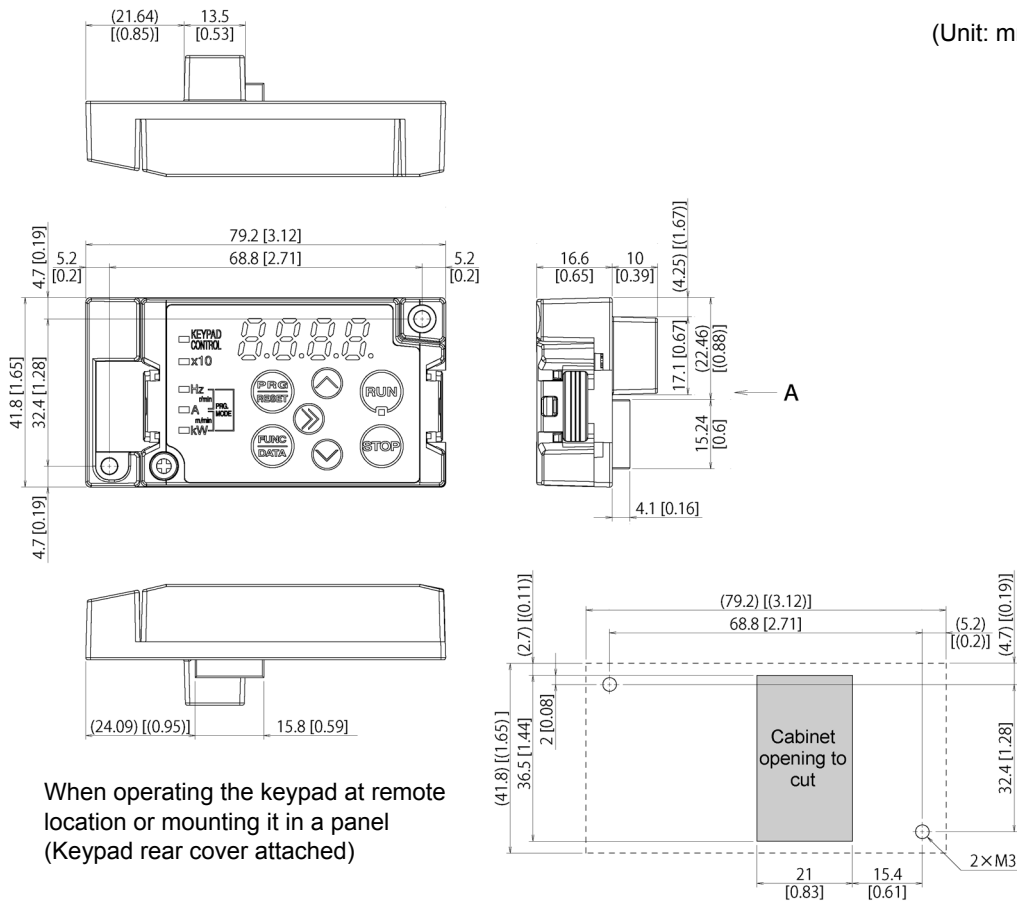



When operating the keypad at remote location or mounting it in a panel (Keypad rear cover attached)

Dimensions of panel cutting (viewed from arrow "A")

APPENDICES

Contents

Appendix A	Trouble-free Use of Inverters (Notes on electrical noise)	1
A.1	Effect of inverters on other devices	1
[1]	Effect on AM radios	1
[2]	Effect on telephones	1
[3]	Effect on proximity switches	1
[4]	Effect on pressure sensors	1
[5]	Effect on position detectors (pulse encoders)	1
A.2	Noise	2
[1]	Inverter noise	2
[2]	Types of noise	3
A.3	Measures	5
[1]	Noise prevention prior to installation	5
[2]	Implementation of noise prevention measures	5
[3]	Noise prevention examples	8
Appendix B	Japanese Guideline for Suppressing Harmonics by Customers Receiving High Voltage or Special High Voltage (General-purpose inverter)	12
B.1	Application to general-purpose inverters	12
[1]	Guideline for suppressing harmonics in home electric and general-purpose appliances	12
[2]	Guideline for suppressing harmonics by customers receiving high voltage or special high voltage	12
B.2	Compliance to the harmonic suppression for customers receiving high voltage or special high voltage	13
[1]	Calculation of equivalent capacity (Pi)	13
[2]	Calculation of Harmonic Current	14
[3]	Examples of calculation	16
Appendix C	Effect on Insulation of General-purpose Motors Driven with 400 V Class Inverters	17
C.1	Generating mechanism of surge voltages	17
C.2	Effect of surge voltages	18
C.3	Countermeasures against surge voltages	19
[1]	Using a surge suppressor unit, SSU (Patent pending)	19

[2]	Suppressing surge voltages	19
[3]	Using motors with enhanced insulation	19
C.4	Regarding existing equipment	20
[1]	In case of a motor being driven with 400 V class inverter	20
[2]	In case of an existing motor driven using a newly installed 400 V class inverter	20
Appendix D	Inverter Generating Loss	21
Appendix E	Conversion from SI Units	22
E.1	Conversion of units	22
E.2	Calculation formulas	23
Appendix F	Allowable Current of Insulated Wires	24
Appendix G	Conformity with Standards	26
G.1	Compliance with European Standards ()	26
[1]	Compliance with EMC standards	26
[2]	Compliance with the low voltage directive in the EU	31
G.2	Harmonic Component Regulation in the EU	38
[1]	General comments	38
[2]	Compliance with the harmonic component regulation	38
G.3	Compliance with UL Standards and Canadian Standards (cUL certification) ()	39
G.4	Compliance with the Radio Waves Act (South Korea) ()	45

Appendix A Trouble-free Use of Inverters (Notes on electrical noise)

Excerpt from technical material of
the Japan Electrical Manufacturers' Association (JEMA) (April 1994)

A.1 Effect of inverters on other devices

Inverters have been and are rapidly expanding its application fields. This paper describes the effect that inverters have on electronic devices already installed or on devices installed in the same system as inverters, as well as introducing noise prevention measures. (Refer to "A.3 [3] Noise prevention examples" for details.)

[1] Effect on AM radios

<u>Phenomena</u>	If an inverter operates, AM radios may pick up noise radiated from the inverter. (An inverter has almost no effect on FM radios or television sets.)
<u>Probable cause</u>	The noise radiated from the inverter may be received by a radio.
<u>Measure</u>	Inserting a noise filter on the power supply side of the inverter is effective.

[2] Effect on telephones

<u>Phenomena</u>	If an inverter operates, nearby telephones may pick up noise radiated from the inverter in conversation so that it may be difficult to hear.
<u>Probable cause</u>	A high-frequency leakage current radiated from the inverter and motors enters shielded telephone cables, causing noise.
<u>Measure</u>	It is effective to commonly connect the grounding terminals of the motors and return the common grounding line to the grounding terminal of the inverter.

[3] Effect on proximity switches

<u>Phenomena</u>	If an inverter operates, proximity switches (capacitance-type) may malfunction.
<u>Probable cause</u>	The capacitance-type proximity switches may provide inferior noise immunity.
<u>Measure</u>	It is effective to connect a filter to the input terminals of the inverter or change the power supply treatment of the proximity switches. The proximity switches can be replaced with superior noise immunity types such as magnetic types.

[4] Effect on pressure sensors

<u>Phenomena</u>	If an inverter operates, pressure sensors may malfunction.
<u>Probable cause</u>	Noise may penetrate through a grounding wire into the signal line.
<u>Measure</u>	It is effective to install a noise filter on the power supply side of the inverter or to change the wiring.

[5] Effect on position detectors (pulse encoders)

<u>Phenomena</u>	If an inverter operates, pulse encoders may produce erroneous pulses that shift the stop position of a machine.
<u>Probable cause</u>	Erroneous pulses are liable to occur when the signal lines of the PG and power lines are bundled together.
<u>Measure</u>	The influence of induction noise and radiated noise can be reduced by separating the PG signal lines and power lines. Providing noise filters at the input and output terminals is also an effective measure.

A.2 Noise

This section gives a summary of noises generated in inverters and their effects on devices subject to noise.

[1] Inverter noise

Figure A-1 shows an outline of the inverter configuration. The inverter converts AC to DC (rectification) in a converter unit, and converts DC to AC (inversion) with 3-phase variable voltage and variable frequency. The conversion (inversion) is performed by PWM implemented by switching six transistors (IGBT: Insulated Gate Bipolar Transistor, etc), and is used for variable speed motor control.

Switching noise is generated by high-speed on/off switching of the six transistors. Noise current (i) is emitted and at each high-speed on/off switching, the noise current flows through stray capacitance (C) of the inverter, cable and motor to the ground. The amount of the noise current is expressed as follows:

$$i = C \cdot dv/dt$$

It is related to the stray capacitance (C) and dv/dt (switching speed of the transistors). Further, this noise current is related to the carrier frequency since the noise current flows each time the transistors are switched on or off.

In addition to the main circuit of the inverter, the DC-to-DC switching power regulator (DC/DC converter), which is the power source for the control circuit of the inverter, may be a noise source in the same principles as stated above.

The frequency band of this noise is less than approximately 30 to 40 MHz. Therefore, the noise will affect devices such as AM radios using low frequency band, but will not virtually affect FM radios and television sets using higher frequency than this frequency band.

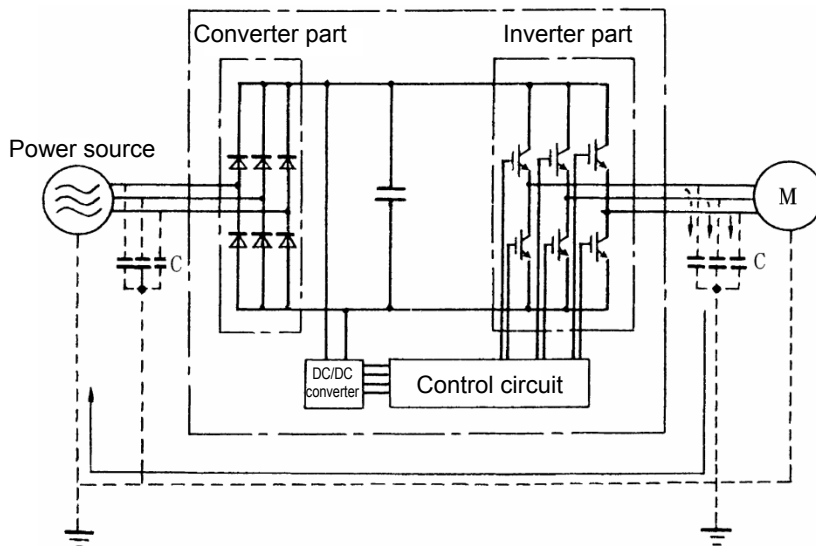

Figure A-1 Outline of Inverter Configuration

[2] Types of noise

Noise generated in an inverter is propagated through the main circuit wiring to the power supply and the motor so as to affect a wide range of applications from the power supply transformer to the motor. The various propagation routes are shown in Figure A-2. According to those routes, noises are roughly classified into three types--conducted noise, induction noise, and radiated noise.

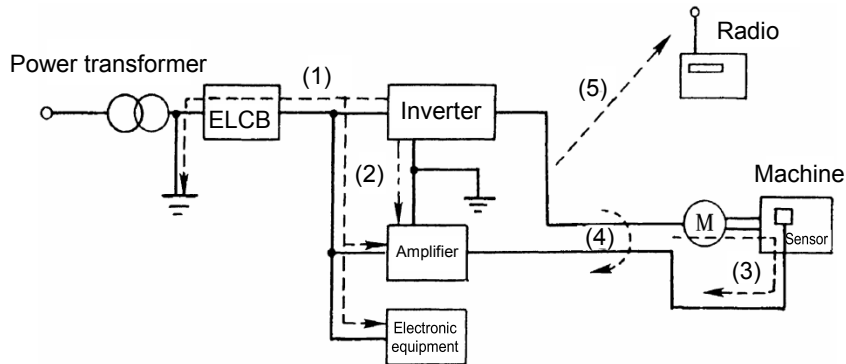

Figure A-2 Noise Propagation Routes

(1) Conducted noise

The noise that has occurred in the inverter and propagates through a conductor to influence peripheral equipment is called conducted noise. Some conducted noise will propagate through the main circuit (1). If the ground wires are connected to a common ground, conducted noise will propagate through route (2). As shown in route (3), some conducted noise will propagate through signal lines or shielded wires.

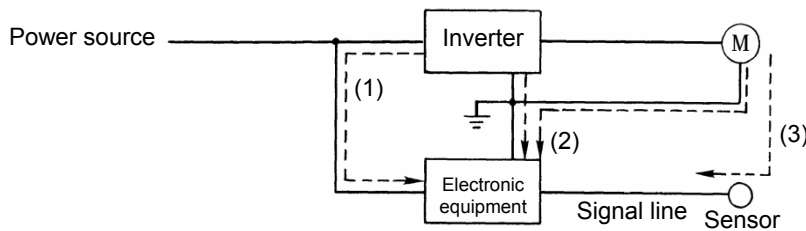

Figure A-3 Conducted Noise

(2) Induction noise

When wires or signal lines of peripheral devices are brought close to the wires on the input and output sides of the inverter through which noise current is flowing, noise will be induced into those wires and signal lines of the devices by electromagnetic induction (Figure A-4) or electrostatic induction (Figure A-5). This is called "induction noise" (4).

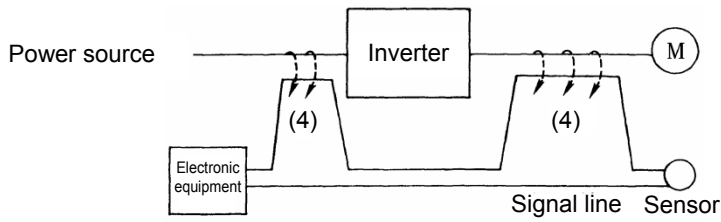

Figure A-4 Electromagnetic Induced Noise

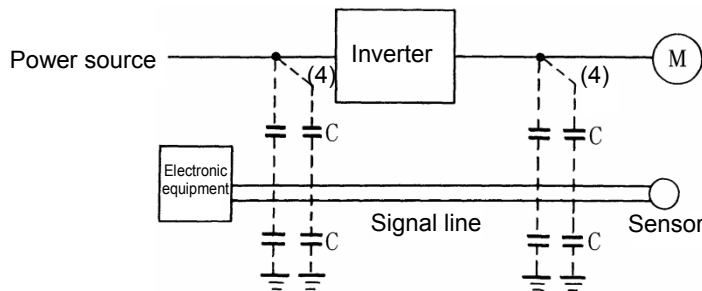

Figure A-5 Electrostatic Induced Noise

(3) Radiated noise

Noise generated in an inverter may be radiated through the air from wires (that act as antennas) at the input and output sides of the inverter so as to affect peripheral devices. This noise is called "radiated noise" as shown below as (5). Not only wires but motor frames or control system panels containing inverters may also act as antennas.

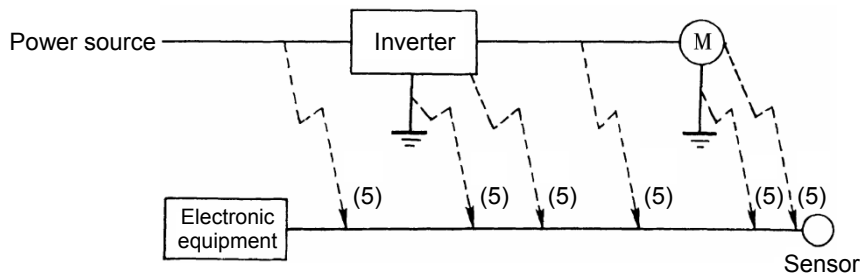

Figure A-6 Radiated Noise

A.3 Measures

As the noise prevention is strengthened, the more effective it is. However, with the use of appropriate measures, noise problems may be resolved easily. It is necessary to implement economical noise prevention according to the noise level and the equipment conditions.

[1] Noise prevention prior to installation

Before installing an inverter in your control panel or installing an inverter panel, you need to consider noise prevention. Once noise problems occur, it will cost additional materials and time for solving them.

Noise prevention prior to installation includes:

- (1) Separate the main circuit from the control circuit.
- (2) Accommodate the main circuit wiring in a metal pipe (conduit pipe).
- (3) Use shielded wire or twisted shielded wire in the control circuit.
- (4) Perform reliable grounding work and wiring.

These noise prevention measures can avoid most noise problems.

[2] Implementation of noise prevention measures

There are two types of noise prevention measures--one for noise propagation routes and the other for noise receiving sides (that are affected by noise).

The basic measures for reducing the effect of noise at the receiving side include: Separating the main circuit wiring from the control circuit wiring, avoiding noise effect.

Measures on the noise-affected side are:

- (1) Lower the noise level for example by installing a noise filter.
- (2) Suppress the noise level for example by using a metal wiring pipe or metal control panel.
- (3) Block the noise propagation route for example by using an insulation transformer for power source.

Table A-1 lists the noise prevention measures, their goals, and propagation routes.

Table A-1 Noise Prevention Measures

Noise prevention method		Goal of noise prevention measures				Conduction route		
		Make it more difficult to receive noise	Cutoff noise conduction	Confine noise	Reduce noise level	Conducted noise	Induction noise	Radiated noise
Wiring and installation	Separate main circuit from control circuit	Y					Y	
	Minimize wiring distance	Y			Y		Y	Y
	Avoid parallel and bundled wiring	Y					Y	
	Use appropriate grounding	Y			Y		Y	Y
	Use shielded wire and twisted shielded wire	Y					Y	Y
	Use shielded cable in main circuit			Y				Y
	Use metal conduit pipe			Y			Y	Y
Control panel	Appropriate arrangement of devices in panel	Y					Y	Y
	Metal control panel			Y			Y	Y
Anti-noise devices	Line filter	Y			Y	Y		Y
	Insulation transformer		Y			Y		Y
Measures taken on noise-affected side	Use a passive capacitor for control circuit	Y					Y	Y
	Use ferrite core for control circuit	Y					Y	Y
	Line filter	Y				Y		
Other	Separate power supply systems	Y	Y			Y		
	Lower the carrier frequency				Y	Y	Y	Y

In the table, a column marked with Y shows a measure expected to produce an effect depending on the conditions. An empty column shows an ineffective measure.

What follows is noise prevention measures for the inverter drive configuration.

(1) Wiring and grounding

As shown in Figure A-7, separate the main circuit wiring from control circuit wiring as far as possible regardless of being located inside or outside the system control panel containing an inverter. Use shielded wires and twisted shielded wires that will block out extraneous noises, and minimize the wiring distance. Also avoid bundled wiring of the main circuit and control circuit or parallel wiring.

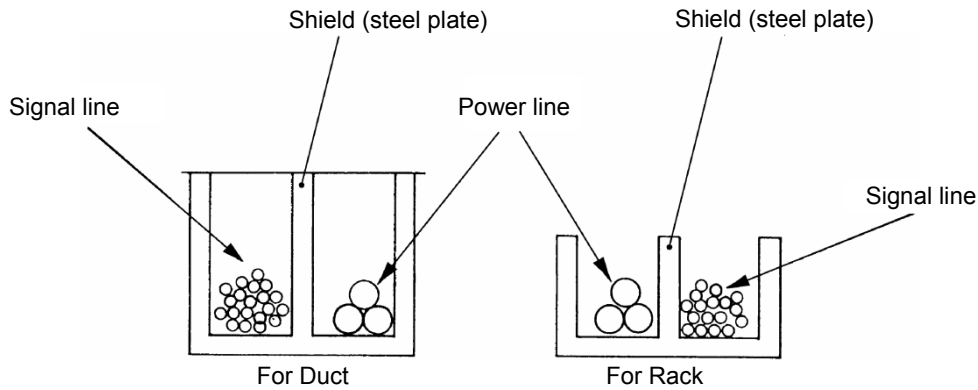

Figure A-7 Separate Wiring

For the main circuit wiring, use a metal conduit pipe and connect its wires to the ground to prevent noise propagation (refer to Figure A-8).

The shield (braided wire) of a shielded wire should be securely connected to the base (common) side of the signal line at only one point to avoid the loop formation resulting from a multi-point connection (refer to Figure A-9).

The grounding is effective not only to reduce the risk of electrical shocks due to leakage current, but also to block noise penetration and radiation. Corresponding to the main circuit voltage, the grounding work should be Class D (300 VAC or less, grounding resistance: 100Ω or less) and Class C (300 to 600 VAC, grounding resistance: 10Ω or less). Each ground wire is to be provided with its own ground or separately wired to a grounding point.

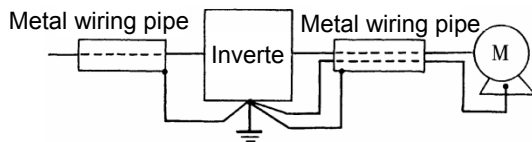

Figure A-8 Grounding of Metal Conduit Pipe

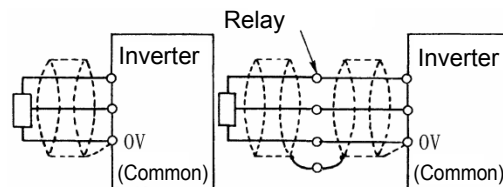

Figure A-9 Treatment of Braided Wire of Shielded Wire

(2) Control panel

The system control panel containing an inverter is generally made of metal, which can shield noise radiated from the inverter itself.

When installing other electronic devices such as a programmable logic controller in the same control panel, be careful with the layout of each device. If necessary, arrange shield plates between the inverter and peripheral devices.

(3) Anti-noise devices

To reduce the noise propagated through the electrical circuits and the noise radiated from the main circuit wiring to the air, a line filter and power supply transformer should be used (refer to Figure A-10).

Line filters are classified into simple-type filters including capacitive filters to be connected in parallel to a power line and inductive filters to be connected in series to a power line and authentic filters (LC filters) to address radio noise restrictions. They are used selectively to meet the target noise reduction effect. Power transformers include generally used insulation transformers, shield transformers and noise-cut transformers, which have different effects to block propagation of noise.

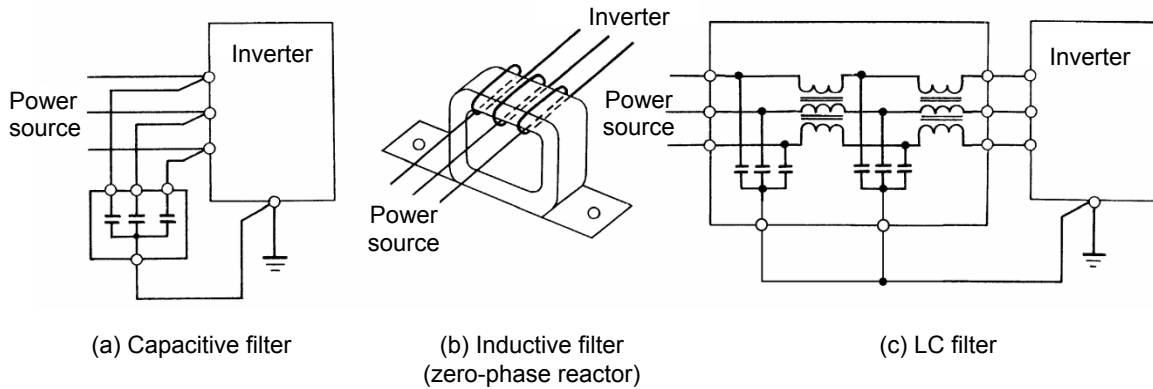

Figure A-10 Various Filters and their Connection

(4) Noise prevention measures at the receiving side

It is important to strengthen the noise immunity of those electronic devices installed in the same control panel as the inverter or located near an inverter. Line filters and shielded or twisted shielded wires are used to block the penetration of noise in the signal lines of these devices. The following treatments are also implemented.

- 1) Lower the circuit impedance by connecting capacitors or resistors to the input and output terminals of the signal circuit in parallel.
- 2) Increase the circuit impedance for noise by inserting choke coils in series in the signal circuit or passing signal lines through ferrite core beads. It is also effective to widen the signal base lines (0 V line) or grounding lines.

(5) Other

The level of generating/propagating noise will change with the carrier frequency of the inverter. The higher the carrier frequency, the higher the noise level.

In an inverter whose carrier frequency can be changed, lowering the carrier frequency can reduce the generation of electrical noise and result in a good balance with the audible noise of the motor under driving conditions.

[3] Noise prevention examples

Table A-2 lists examples of the measures to prevent noise generated by a running inverter.

Table A-2 Examples of Noise Prevention Measures

No.	Target device	Phenomena	Measure	Notes
1	AM radio	<p>Noise enters the AM radio broadcast (500-1500kHz) when the inverter is operated.</p>  <p><Possible cause> Radiated noise from the power source and output wiring of inverter was received by the AM radio.</p>	<ol style="list-style-type: none"> 1) Install an LC filter at the power supply side of the inverter. (In some cases, a capacitive filter may be used as a simple method.) 2) Install a metal conduit wiring between the motor and inverter.  <p>Note: Minimize the distance between the LC filter and the inverter (within 1 m).</p>	<ol style="list-style-type: none"> 1) The radiated noise of the wiring can be reduced. 2) Reduce the conducted noise to the power source or apply shielded wiring. <p>Note: Sufficient improvement may not be expected in narrow regions such as between mountains.</p>
2	AM radio	<p>Noise enters the AM radio broadcast (500 to 1500kHz) when the inverter is operated.</p>  <p><Possible cause> Radiated noise from the power line of inverter's power source was received by the AM radio.</p>	<ol style="list-style-type: none"> 1) Install inductive filters at the input and output sides of the inverter.  <p>The number of turns of the zero-phase reactor (or ferrite ring) should be as large as possible. Minimize the distance between the inverter and the inductive filter (within 1 m).</p> <ol style="list-style-type: none"> 2) When further improvement is necessary, install LC filters. 	<ol style="list-style-type: none"> 1) The radiated noise of the wiring can be reduced.

Table A-2 Examples of Noise Prevention Measures (Continued)

No.	Target device	Phenomena	Measure	Notes
3	Telephone (in a common private residence at a distance of 40 m)	<p>When driving a ventilation fan with an inverter, noise enters a telephone in a private residence at a distance of 40 m.</p>  <p><Possible cause> High-frequency leak current of the inverter and motor flows into the shielded ground of the telephone cable on the way back via the ground of the pole transformer to cause noise by electrostatic induction.</p>	<p>1) Connect the ground terminals of the motors in a common connection. Return to the inverter panel, and insert a 1 μF capacitor between the input terminal of the inverter and ground.</p>  	<p>1) The effect of the inductive filter and LC filter may not be expected because of sound frequency component.</p> <p>2) In the case of a V-connection power supply transformer in a 200V system, it is necessary to connect capacitors as shown in the following figure, because of different potentials to ground.</p>
4	Photo-electric relay	<p>A photoelectric relay malfunctioned when the inverter runs the motor. [The inverter and motor are installed in the same place (for overhead traveling)]</p>  <p><Possible cause> Input power line of the inverter and wiring of the photoelectric relay run parallel for 30 to 40 m with a spacing of about 25 mm, which invites induction noise. Due to conditions of the installation, these lines cannot be separated.</p>	<p>1) As a temporary measure, Insert a 0.1 μF capacitor between the 0 V terminal of the power supply circuit in the detection unit of the overhead photoelectric relay and a frame of the overhead panel.</p>  <p>2) As a permanent measure, move the 24 V power supply from the ground to the overhead unit so that signals are sent to the ground side with relay contacts in the ceiling part.</p>	<p>1) Separate the wiring (30 cm or more).</p> <p>2) When separation is impossible, signals can be received and sent with dry contacts etc.</p> <p>3) Do not wire low-current signal lines and power lines in parallel.</p>

Table A-2 Examples of Noise Prevention Measures (Continued)

No.	Target device	Phenomena	Measure	Notes
5	Photo-electric relay	<p>A photoelectric relay malfunctioned when the inverter was operated.</p>  <p><Possible cause> While the inverter is sufficiently away from the photoelectric relay, the power source is connected in common. Conducted noise has entered from the power source line.</p>	<p>1) Insert a 0.1 μF capacitor between the output common terminal of the amplifier of the photoelectric relay and the frame.</p> 	<p>1) If a low-current circuit at the malfunctioning side is observed, the measures may be simple and economical.</p>
6	Proximity switch (capacitance type)	<p>A proximity switch malfunctioned.</p>  <p><Possible cause> The electrostatic capacitive proximity switch has a low noise immunity, and is vulnerable to circuit conducted noise and radiated noise.</p>	<p>1) Install an LC filter at the output side of the inverter. 2) Install a capacitive filter at the input side of the inverter. 3) Ground the 0 V (common) line of the DC power supply of the proximity switch through a capacitor to the box body of the machine.</p> 	<p>1) Noise generated in the inverter can be reduced. 2) The switch is superseded by a proximity switch of superior noise immunity (such as a magnetic type).</p>
7	Pressure sensor	<p>A pressure sensor malfunctioned.</p>  <p><Possible cause> Noise enters from the box body via the shielded wire to cause malfunctioning of the pressure sensor.</p>	<p>1) Install an LC filter on the input side of the inverter. 2) Connect the shield of the shielded wire of the pressure sensor to the 0 V line (common) of the pressure sensor, changing the original connection.</p> 	<p>1) The shielded parts of shield wires for sensor signals are connected to a common point in the system. 2) Conducted noise from the inverter can be reduced.</p>

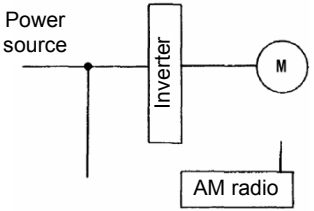
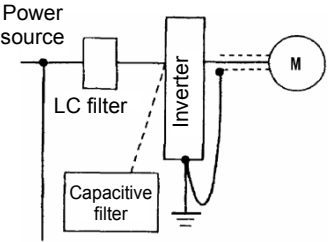
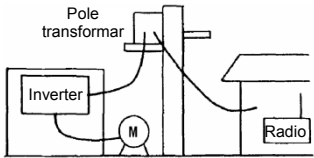
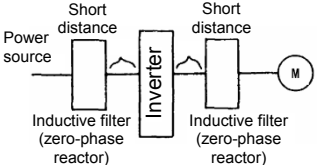
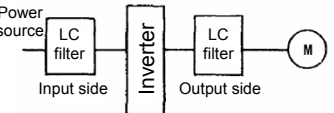
Table A-2 Examples of Noise Prevention Measures (Continued)

No.	Target device	Phenomena	Measure	Notes
8	Position detector (pulse encoder)	<p>Erroneous-pulse outputs from a pulse converter caused a shift in the stop position of a crane.</p>  <p><Possible cause> The motor power line and the signal line for the encoder are wired together in a bundle. This produces induction noise to cause output of error pulses.</p>	<ol style="list-style-type: none"> 1) Install an LC filter and a capacitive filter at the input side of the inverter. 2) Install an LC filter at the output side of the inverter. 	<ol style="list-style-type: none"> 1) This is an example of a measure where the power line and signal line cannot be separated. 2) Induction noise and radiated noise at the output side of the inverter can be reduced.
9	Program mable logic controller (PLC)	<p>The PLC program sometimes malfunctions.</p>  <p><Possible cause> Power sources of the inverter and PLC are in the same system so that noise enters PLC via the power source.</p>	<ol style="list-style-type: none"> 1) Install a capacitive filter and an LC filter on the input side of the inverter. 2) Install an LC filter on the output side of the inverter. 3) Lower the carrier frequency of the inverter. 	<ol style="list-style-type: none"> 1) Total conducted noise and induction noise in the electric line can be reduced.

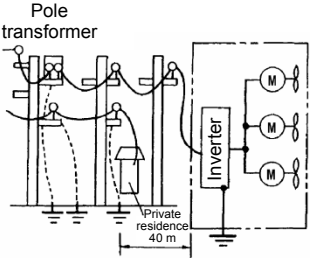
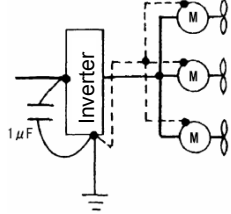
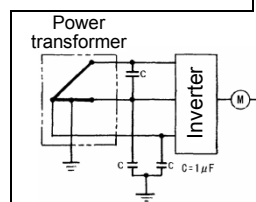
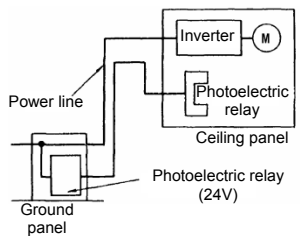
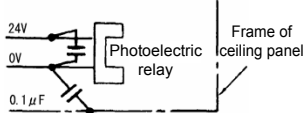
Appendix B Japanese Guideline for Suppressing Harmonics by Customers Receiving High Voltage or Special High Voltage (General-purpose inverter)

Agency of Natural Resource and Energy of Japan published the following two guidelines for suppressing harmonic noise in September 30, 1994.

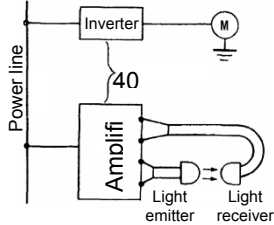
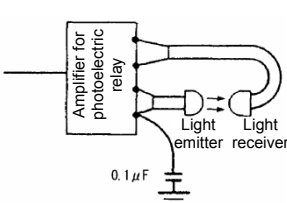
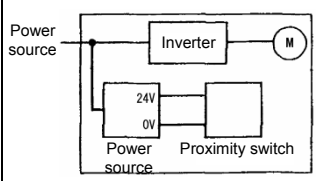
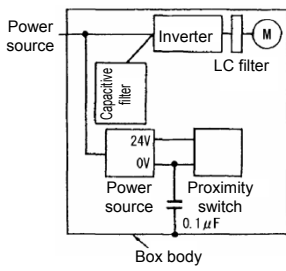
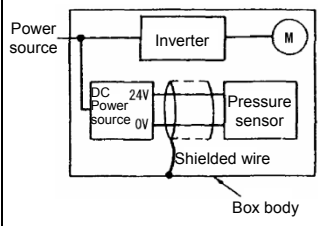
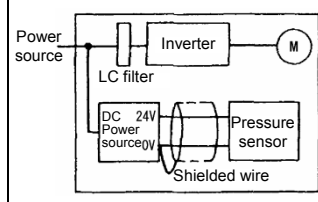
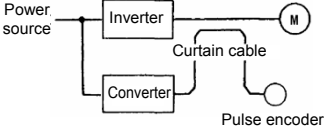
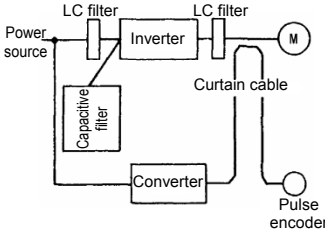
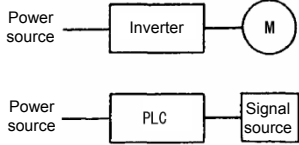
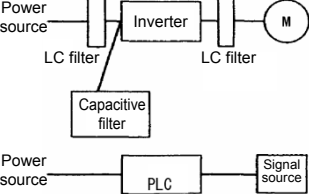
- (1) "Guideline to reduce harmonic emissions caused by electrical and electronic equipment for household and general use"
- (2) "Guideline of harmonics reduction for consumers with high or ultra-high voltage power receiving facilities"

Assuming that electronic devices generating high harmonics will be increasing, these guidelines are to establish regulations for preventing high frequency noise interference on devices sharing the power source. These guidelines should be applied to all devices that are used on the commercial power lines and generate harmonic current. This section gives a description limited to general-purpose inverters.

B.1 Application to general-purpose inverters

[1] Guideline for suppressing harmonics in home electric and general-purpose appliances

Our three-phase, 200 V class series inverters of 3.7 kW or less (FRENIC-MEGA series) were the products of which were restricted by the "Guideline for Suppressing Harmonics in Home Electric and General-purpose Appliances" (established in September 1994 and revised in October 1999) issued by the Ministry of Economy, Trade and Industry. The above restriction, however, was lifted when the Guideline was revised in January 2004. Since then, the inverter makers have individually imposed voluntary restrictions on the harmonics of their products. We, as before, recommend that you connect a reactor (for suppressing harmonics) to your inverter.

[2] Guideline for suppressing harmonics by customers receiving high voltage or special high voltage

Unlike other guidelines, this guideline is not applied to the equipment itself such as a general-purpose inverter, but is applied to each large-scale electric power consumer for total amount of harmonics. Regulation is applied to each power consumer rather than direct regulation of harmonic current generating equipment such as the "general-purpose inverter". Calculation of the amount of generated harmonic current is necessary on individual equipment.

(1) Scope of regulation

In principle, the guideline applies to the customers that meet the following two conditions:

- The customer receives high voltage or special high voltage.
- The "equivalent capacity" of the converter load exceeds the standard value for the receiving voltage (50 kVA at a receiving voltage of 6.6 kV).

"B.2 [1] Calculation of equivalent capacity (Pi)" gives you some supplemental information with regard to estimation for the equivalent capacity of an inverter according to the guideline.

(2) Regulation

The level (calculated value) of the harmonic current that flows from the customer's receiving point out to the system is subjected to the regulation. The regulation value is proportional to the contract demand. The regulation values specified in the guideline are shown in Table B-1.

"B.2 Compliance to the harmonic suppression for customers receiving high voltage or special high voltage" gives you some supplemental information with regard to estimation for the equivalent capacity of the inverter for compliance to "Japanese guideline for suppressing harmonics by customers receiving high voltage or special high voltage."

Table B-1 Upper Limits of Harmonic Outflow Current per kW of Contract Demand (mA/kW)

Receiving voltage	5th	7th	11th	13th	17th	19th	23rd	Over 25th
6.6kV	3.5	2.5	1.6	1.3	1.0	0.90	0.76	0.70
22kV	1.8	1.3	0.82	0.69	0.53	0.47	0.39	0.36

(3) When the regulation applied

The guideline has been applied.

The estimation for “Voltage distortion factor” required as the indispensable conditions when entering into the consumer’s contract of electric power is already expired.

B.2 Compliance to the harmonic suppression for customers receiving high voltage or special high voltage

When calculating the required matters related to inverters according to the guideline, follow the terms listed below. The following descriptions are based on “Technical document for suppressing harmonics” (JEAG 9702-1995) published by the Japan Electrical Manufacturer’s Association (JEMA).

[1] Calculation of equivalent capacity (Pi)

The equivalent capacity (Pi) may be calculated using the equation of (input rated capacity) x (conversion factor). However, catalogs of conventional inverters do not contain input rated capacities, so a description of the input rated capacity is shown below:

(1) “Inverter rated capacity” corresponding to “Pi”

- In the guideline, the conversion factor of a 6-pulse converter is used as reference conversion factor 1. It is, therefore, necessary to express the rated input capacity of inverters in a value including harmonic component current equivalent to conversion factor 1.
- In particular, calculate the input fundamental current I_1 from the kW rating and efficiency of the motor and the efficiency of the inverter as loads and then calculate:

$$\text{Input rated capacity} = \sqrt{3} \times (\text{power voltage}) \times I_1 \times 1.0228/1000 \text{ (kVA)}$$
 Then, calculate the input rated capacity as shown below: where 1.0228 is the 6-pulse converter’s value of (effective current)/ (fundamental current).
- When a general-purpose motor or inverter motor is used, the appropriate value shown in Table B-2 can be used. Select a value based on the kW rating of the motor used, irrespective of the inverter type.

 **Note** The input rated capacity shown above is for the dedicated use in the equation to calculate capacity of the inverters, following the guideline. Note that the capacity cannot be applied to the reference for selection of the equipment or wires to be used in the inverter input circuits.

 For selection of capacity for the peripheral equipment, refer to the catalogs or technical documents issued from their manufacturers.

Table B-2 “Input Rated Capacities” of General-purpose Inverters Determined by the Applicable Motor Ratings

Applicable motor rating (kW)		0.4	0.75	1.5	2.2	3.7	5.5	7.5	11	15	18.5
Pi (kVA)	200V	0.57	0.97	1.95	2.81	4.61	6.77	9.07	13.1	17.6	21.8
	400V	0.57	0.97	1.95	2.81	4.61	6.77	9.07	13.1	17.6	21.8
Applicable motor rating (kW)		22	30	37	45	55	75	90	110	132	160
Pi (kVA)	200V	25.9	34.7	42.8	52.1	63.7	87.2	104	127		
	400V	25.9	34.7	42.8	52.1	63.7	87.2	104	127	153	183
Applicable motor rating (kW)		200	220	250	280	315	355	400	450	500	630
Pi (kVA)	200V										
	400V	229	252	286	319	359	405	456	512	570	718

(2) Values of “Ki (conversion factor)”

Depending on whether an optional ACR (AC reactor) or DCR (DC reactor) is used, apply the appropriate conversion factor specified in the appendix to the guideline. The values of the conversion factor are listed in Table B-3.

Table B-3 “Conversion Factors Ki” for General-purpose Inverters Determined by Reactors

Circuit category	Circuit type		Conversion factor Ki	Main applications
3	Three-phase bridge (Capacitor smoothing)	w/o a reactor	K31=3.4	<ul style="list-style-type: none"> • General-purpose inverter • Elevator • Cold air refrigerating machine • Other equipment in general
		w/- a reactor (ACR)	K32=1.8	
		w/- a reactor (DCR)	K33=1.8	
		w/- reactors (ACR and DCR)	K34=1.4	

Note Some models are equipped with a reactor as a standard accessory.

[2] Calculation of Harmonic Current

(1) Value of “input fundamental current”

- When you calculate the amount of harmonics according to Table 2 in Appendix of the Guideline, you have to previously know the input fundamental current.
- Apply the appropriate value shown in Table B-4 based on the kW rating of the motor, irrespective of the inverter type or whether a reactor is used.

Note If the input voltage is different, calculate the input fundamental current in inverse proportion to the voltage.

Table B-4 “Input Fundamental Currents” of General-purpose Inverters Determined by the Applicable Motor Ratings

Applicable motor rating (kW)	0.4	0.75	1.5	2.2	3.7	5.5	7.5	11	15	18.5	
Input fundamental current (A)	200V	1.62	2.74	5.50	7.92	13.0	19.1	25.6	36.9	49.8	61.4
	400V	0.81	1.37	2.75	3.96	6.50	9.55	12.8	18.5	24.9	30.7
6.6 kV converted value (mA)	49	83	167	240	394	579	776	1121	1509	1860	

Applicable motor rating (kW)	22	30	37	45	55	75	90	110	132	160
Input fundamental current (A)	200V	73.1	98.0	121	147	180	245	293	357	
	400V	36.6	49.0	60.4	73.5	89.9	123	147	179	216
6.6 kV converted value (mA)	2220	2970	73.5	4450	5450	7450	8910	10850	13090	15640

Applicable motor rating (kW)	200	220	250	280	315	355	400	450	500	630
Input fundamental current (A)	200V									
	400V	323	355	403	450	506	571	643	723	804
6.6 kV converted value (mA)	19580	21500	24400	27300	30700	34600	39000	43800	48700	61400

(2) Calculation of harmonic current

Usually, calculate the harmonic current according to the Sub-table 3 “Three-phase bridge rectifier with the smoothing capacitor” in Table 2 of the Guideline’s Appendix. Table B-5 lists the contents of the Sub-table 3.

Table B-5 Generated Harmonic Current (%), 3-phase Bridge Rectifier (Capacitor Smoothing)

Degree	5th	7th	11th	13th	17th	19th	23rd	25th
w/o a reactor	65	41	8.5	7.7	4.3	3.1	2.6	1.8
w/- a reactor (ACR)	38	14.5	7.4	3.4	3.2	1.9	1.7	1.3
w/- a reactor (DCR)	30	13	8.4	5.0	4.7	3.2	3.0	2.2
w/- reactors (ACR and DCR)	28	9.1	7.2	4.1	3.2	2.4	1.6	1.4

- ACR: 3%
- DCR: Accumulated energy equal to 0.08 to 0.15 ms (100% load conversion)
- Smoothing capacitor: Accumulated energy equal to 15 to 30 ms (100% load conversion)
- Load: 100%

$$\text{nth harmonic current (A)} = \text{Fundamental current (A)} \times \frac{\text{Generated nth harmonic current (\%)}}{100}$$

Calculate the harmonic current of each degree using the following equation:

(3) Maximum availability factor

- For a load like elevators, which provides intermittent operation, or a load with a sufficient designed motor rating, reduce the current by multiplying the equation by the “maximum availability factor” of the load.
- According to the Appendix to Guideline, “Maximum availability factor of equipment refers to the ratio of the maximum capacity of the operating equipment to the total capacity of the harmonic generation equipment. Capacity of the operating equipment shall be an average value over 30 minutes.”
- In general, the maximum availability factor is calculated according to this definition, but the standard values shown in Table B-6 are recommended for inverters for building equipment.

Table B-6 Availability Factors of Inverters, etc. for Building Equipment (Standard Values)

Equipment type	Inverter capacity category	Single inverter availability
Air conditioning system	200 kW or less	0.55
	Over 200 kW	0.60
Sanitary pump	-	0.30
Elevator	-	0.25
Refrigerator, freezer	50 kW or less	0.60
UPS (6-pulse)	200kVA	0.60

Correction coefficient according to contract demand level

Since the total availability factor decreases if the scale of a building increases, the calculation of reduced harmonics with the correction coefficient β defined in Table B-7 is permitted.

Table B-7 Correction Coefficient according to the Building Scale

Contract demand (kW)	Correction coefficient β
300	1.00
500	0.90
1,000	0.85
2,000	0.80

Note: If the contract demand is between two specified values listed in Table B-7, calculate the value by interpolation.

Note: The correction coefficient β is to be determined as a matter of consultation between the customer and electric power company for the customers receiving the electric power over 2000 kW or from the special high voltage lines.

(4) Degree of harmonics to be calculated

The higher the degree of harmonics, the lower the current flows. This is the property of harmonics generated by inverters so that the inverters are covered by “The case not causing a special hazard” of the term 3.(3) in the above Appendix for the 9th or higher degrees of the harmonics.

Therefore, “It is sufficient that the 5th and 7th harmonic currents should be calculated.”

[3] Examples of calculation

(1) Equivalent capacity

Example of loads	Input capacity and No. of inverters	Conversion factor	Equivalent capacity
[Example (1)] 400V, 3.7kW, 10 units w/- AC/DC reactor	4.61 kVA × 10 units	K32=1.4	4.61 × 10 × 1.4= 64.54 kVA
[Example (2)] 400V, 1.5kW, 15 units w/- AC reactor	2.93 kVA × 15 units	K34=1.8	2.93 × 15 × 1.8= 79.11 kVA
	Refer to Table B-2.	Refer to Table B-3.	

(2) Harmonic current for every harmonic order

Example 1: 400V, 3.7kW, 10 units (w/- AC reactor), maximum availability factor: 0.55

6.6kV side fundamental current (mA)	Harmonic current onto 6.6 kV lines (mA)							
	5th (38%)	7th (14.5%)	11th (7.4%)	13th (3.4%)	17th (3.2%)	19th (1.9%)	23th (1.7%)	25th (1.3%)
394 × 10= 3940 3940 × 0.55= 2167	823.5	314.2						
Refer to Table B-4 and Table B-6.	Refer to Table B-5.							

Example 2: 400V, 3.7kW, 15 units (w/- AC/DC reactor), maximum availability factor: 0.55

6.6kV side fundamental current (mA)	Harmonic current onto 6.6 kV lines (mA)							
	5th (28%)	7th (9.1%)	11th (7.2%)	13th (4.1%)	17th (3.2%)	19th (2.4%)	23th (1.6%)	25th (1.4%)
394 × 15= 5910 5910 × 0.55= 3250.5	910.1	295.8						
Refer to Table B-4 and Table B-6.	Refer to Table B-5.							

Appendix C Effect on Insulation of General-purpose Motors Driven with 400 V Class Inverters

Excerpt from technical material of
the Japan Electrical Manufacturers' Association (JEMA) (March 1995)

Preface

When an inverter drives a motor, surge voltages generated by switching the inverter elements are superimposed on the inverter output voltage and applied to the motor terminals. If the surge voltages are too high they may have an effect on the motor insulation and some cases have resulted in damage.

For preventing such cases this document describes the generating mechanism of the surge voltages and countermeasures against them.

 Refer to "A.2 [1] Inverter noise" for details of the principle of inverter operation.

C.1 Generating mechanism of surge voltages

As the inverter rectifies a commercial power source voltage and smoothes into a DC voltage, the magnitude E of the DC voltage becomes about $\sqrt{2}$ times that of the source voltage (about 620 V in case of an input voltage of 440 VAC). The peak value of the output voltage is usually close to this DC voltage value.

But, as there exists inductance (L) and stray capacitance (C) in wiring between the inverter and the motor, the voltage variation due to switching the inverter elements causes a surge voltage originating in LC resonance and results in the addition of high voltage to the motor terminals. (Refer to Figure C-1)

This voltage sometimes reaches up to about twice that of the inverter DC voltage ($620 \text{ V} \times 2 =$ approximately 1,200 V) depending on a switching speed of the inverter elements and wiring conditions.

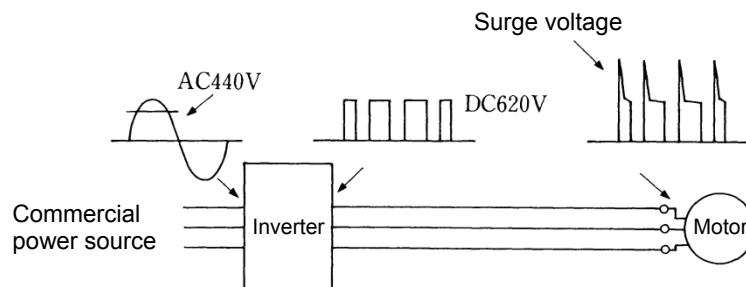
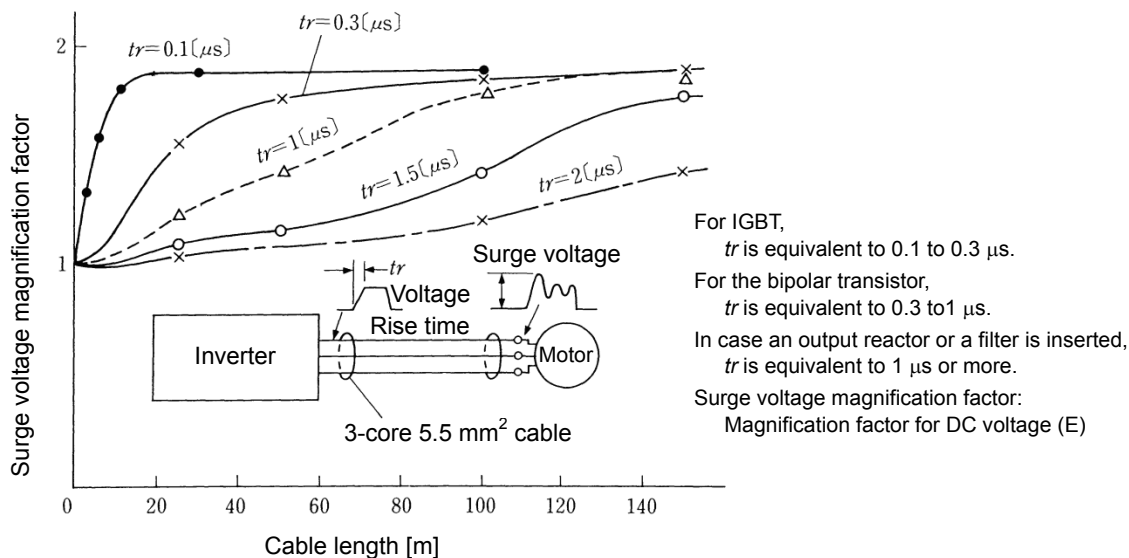

Figure C-1 Voltage Waveform of Individual Portions

A measured example in Figure C-2 illustrates the relation of a peak value of the motor terminal voltage with a wiring length between the inverter and the motor.

From this it can be confirmed that the peak value of the motor terminal voltage ascends as the wiring length increases and becomes saturated at about twice the inverter DC voltage.

The shorter a pulse rise time becomes, the higher the motor terminal voltage rises even in the case of a short wiring length.



Excerpt from Journal of IEEJ, No. 7, vol. 107, 1987

Figure C-2 Measured Example of Wiring Length and Peak Value of Motor Terminal Voltage

C.2 Effect of surge voltages

The surge voltages originated in LC resonance of wiring may be applied to the motor terminals and depending on their magnitude sometimes cause damage to the motor insulation.

When the motor is driven with a 200 V class inverter, the dielectric strength of the insulation is no problem even the peak value at the motor terminal voltage increases twice due to the surge voltages (the DC voltage is only about 300 V).

But in case of a 400 V class inverter, the DC voltage is approximately 600 V and depending on the wiring length, the surge voltages may greatly increase and sometimes result in damage to the insulation.

C.3 Countermeasures against surge voltages

When driving a motor with a 400 V class inverter, the following are countermeasures against damage to the motor insulation by the surge voltages.

[1] Using a surge suppressor unit, SSU (Patent pending)

The surge suppressor unit (SSU) is a newly structured unit using circuits based on the impedance-matching theory of a transmission line. Just connecting the SSU to the surge suppressor cable of the existing equipment can greatly reduce the surge voltage that results in a motor dielectric breakdown.



For 50 m of wiring length: SSU 50TA-NS



For 100 m of wiring length: SSU 100TA-NS

[2] Suppressing surge voltages

There are two ways for suppressing the surge voltages, one is to reduce the voltage rise time and another is to reduce the voltage peak value.

(1) Output reactor

If wiring length is relatively short, the surge voltages can be suppressed by reducing the voltage rise time (dv/dt) with the installation of an AC reactor on the output side of the inverter. Refer to Figure C-3 (1).

However, if the wiring length becomes long, suppressing the peak voltage due to surge voltage may be difficult.

(2) Output filter

Installing a filter on the output side of the inverter allows the peak value of the motor terminal voltage to be reduced. Refer to Figure C-3 (2).

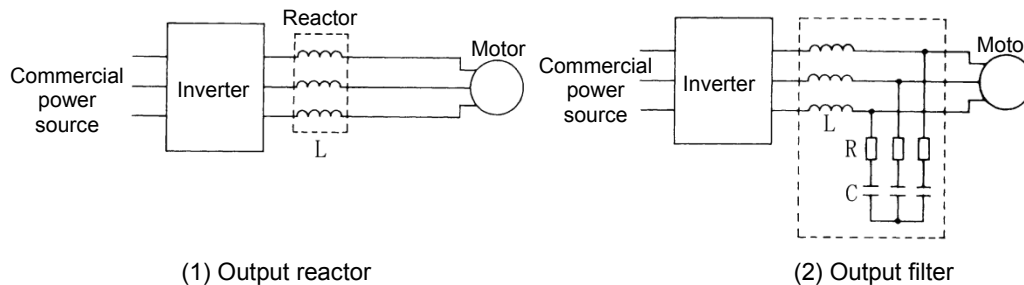

Figure C-3 Method to Suppress Surge Voltage



If the wiring length between the inverter and the motor is comparatively long, the crest value of the surge voltage can be suppressed by connecting a surge suppressor unit (SSU) to the motor terminal. For details, refer to Chapter 11 “11.12 Surge Suppression Unit (SSU).”

[3] Using motors with enhanced insulation

Enhanced insulation of a motor winding allows its surge withstanding to be improved.

C.4 Regarding existing equipment

[1] In case of a motor being driven with 400 V class inverter

A survey over the last five years on motor insulation damage due to the surge voltages originating from switching of inverter elements shows that the damage incidence is 0.013% under the surge voltage condition of over 1,100 V and most of the damage occurs several months after commissioning the inverter. Therefore there seems to be little probability of occurrence of motor insulation damage after a lapse of several months of commissioning.

[2] In case of an existing motor driven using a newly installed 400 V class inverter

We recommend suppressing the surge voltages with the methods shown in "C.3 Countermeasures against surge voltages".

Appendix D Inverter Generating Loss

The table below lists the inverter generating loss.

Unit: W

Power system	Inverter type	Carrier frequency (Functional code:F26)					
		ND mode	HD mode	HND mode		HHD mode	
		Factory shipment value	Factory shipment value	Factory shipment value	Maximum set value	Factory shipment value	Maximum set value
3-phase 200V	FRN0001E2■-2□	-	-	19	22	16	18
	FRN0002E2■-2□	-	-	29	34	23	27
	FRN0004E2■-2□	-	-	47	51	35	39
	FRN0006E2■-2□	-	-	66	71	54	58
	FRN0010E2■-2□	-	-	94	115	74	95
	FRN0012E2■-2□	-	-	115 (*1)	145 (*1)	98	125
	FRN0020E2■-2□	-	-	210 (*1)	285 (*1)	165	230
	FRN0030E2■-2□	-	-	210	280	170	230
	FRN0040E2■-2□	-	-	370	460	280	360
	FRN0056E2■-2□	-	-	560	670	440	540
	FRN0069E2■-2□	-	-	620	830	520	700
	FRN0088E2■-2□	-	-	770	970	660	860
	FRN0115E2■-2□	-	-	1120	1250	790	1040
	3-phase 400V	FRN0002E2■-4□	33	32	32	56	30
FRN0004E2■-4□		57	50	50	93	40	72
FRN0006E2■-4□		73	69	69	120	57	100
FRN0007E2■-4□		98	95	-	-	79	145
FRN0012E2■-4□		155	150	-	-	120	215
FRN0022E2■-4□		260	190	190	370	150	280
FRN0029E2■-4□		380	290	290	510	220	390
FRN0037E2■-4□		460	390	390	630	300	490
FRN0044E2■-4□		470	410	410	750	330	600
FRN0059E2■-4□		710	510	510	870	440	770
FRN0072E2■-4□		900	750	710	1000	510	900
FRN0085E2■-4□		1200	1000	1000	1250	800	1150
FRN0105E2■-4□		1350	1200	1200	1550	1000	1450
FRN0139E2■-4□		1700	1300	1300	1700	1100	1600
FRN0168E2■-4□		2000	1850	1850	2300	1350	1950
FRN0203E2■-4□		2250	1950	1950	2250	1600	2150
FRN0240E2■-4□		2700	2250	2250	2550	1900	2600
FRN0290E2■-4□		3200	2700	2700	3050	2300	3050
FRN0361E2■-4□		3900	3050	3050	3400	2500	3300
FRN0415E2■-4□		4250	3900	3900	4350	3100	4000
FRN0520E2■-4□	5400	4250	4250	4750	3850	5000	
FRN0590E2■-4□	6200	4850	5500	6100	4350	5600	
Single-phase 200V	FRN0001E2■-7□	-	-	-	-	16	18
	FRN0002E2■-7□	-	-	-	-	23	27
	FRN0003E2■-7□	-	-	-	-	36	40
	FRN0005E2■-7□	-	-	-	-	55	59
	FRN0008E2■-7□	-	-	-	-	78	100
	FRN0011E2■-7□	-	-	-	-	100	130

Note 1: The maximum set value (max. carrier) differs depending on specification. For details please refer to Chapter 5 "FUNCTION CODE" F26.

Note 2: When ND/HD specification units are operated at maximum carrier, reduce output to 60% of rated current. At that setting, generated losses will be at same level as the factory shipment value.

(*1) ND spec.

Appendix E Conversion from SI Units

All expressions given in Chapter 10 "SELECTING OPTIMAL MOTOR AND INVERTER CAPACITIES" are based on SI units (The International System of Units). This section explains how to convert expressions to other units.

E.1 Conversion of units

(1) Force

- 1 [kgf] \approx 9.8 [N]
- 1 [N] \approx 0.102 [kgf]

(2) Torque

- 1 [kgf•m] \approx 9.8 [N•m]
- 1 [N•m] \approx 0.102 [kgf•m]

(3) Power (energy)

- 1 [kgf•m] \approx 9.8 [N•m] = 9.8 [J] = 9.8 [W•s]

(4) Power

- 1 [kgf•m/s] \approx 9.8 [N•m/s] = 9.8 [J/s] = 9.8 [W]
- 1 [N•m/s] \approx 1 [J/s] = 1 [W] \approx 0.102 [kgf•m/s]

(5) Rotation speed

- 1 [min^{-1}] = $\frac{2\pi}{60}$ [rad/s] \approx 0.1047 [rad/s]
- 1 [rad/s] = $\frac{60}{2\pi}$ [min^{-1}] \approx 9.549 [min^{-1}]

(6) Inertia constant

J [$\text{kg}\cdot\text{m}^2$] : moment of inertia

GD² [$\text{kg}\cdot\text{m}^2$]: flywheel effect

- $\text{GD}^2 = 4J$

$$J = \frac{\text{GD}^2}{4}$$

(7) Pressure, stress

- 1 [mmAq] \approx 9.8 [Pa] \approx 9.8 [N/m^2]
- 1 [Pa] \approx 1 [N/m^2] \approx 0.102 [mmAq]
- 1 [bar] \approx 100000 [Pa] \approx 1.02 [$\text{kg}\cdot\text{cm}^2$]
- 1 [$\text{kg}\cdot\text{cm}^2$] \approx 98000 [Pa] \approx 980 [mbar]
- 1 barometric pressure
= 1013 [mbar] = 760 [mmHg]
= 101300 [Pa] \approx 1.033 [kg/cm^2]

E.2 Calculation formulas

(1) Torque, power, rotation speed

- $P [W] \approx \frac{2\pi}{60} \cdot N [\text{min}^{-1}] \cdot \tau [\text{N} \cdot \text{m}]$
- $P [W] \approx 1.026 \cdot N [\text{min}^{-1}] \cdot T [\text{kgf} \cdot \text{m}]$
- $\tau [\text{N} \cdot \text{m}] \approx 9.55 \cdot \frac{P [W]}{N [\text{min}^{-1}]}$
- $T [\text{kgf} \cdot \text{m}] \approx 0.974 \cdot \frac{P [W]}{N [\text{min}^{-1}]}$

(2) Kinetic energy

- $E [J] \approx \frac{1}{182.4} \cdot J [\text{kg} \cdot \text{m}^2] \cdot N^2 [(\text{min}^{-1})^2]$
- $E [J] \approx \frac{1}{730} \cdot GD^2 [\text{kg} \cdot \text{m}^2] \cdot N^2 [(\text{min}^{-1})^2]$

(3) Linear motion load torque

[Driving mode]

- $\tau [\text{N} \cdot \text{m}] \approx 0.159 \cdot \frac{V [\text{m}/\text{min}]}{N_M [\text{min}^{-1}] \cdot \eta_G} \cdot F [\text{N}]$
- $T [\text{kgf} \cdot \text{m}] \approx 0.159 \cdot \frac{V [\text{m}/\text{min}]}{N_M [\text{min}^{-1}] \cdot \eta_G} \cdot F [\text{kgf}]$

[Braking mode]

- $\tau [\text{N} \cdot \text{m}] \approx 0.159 \cdot \frac{V [\text{m}/\text{min}]}{N_M [\text{min}^{-1}] / \eta_G} \cdot F [\text{N}]$
- $T [\text{kgf} \cdot \text{m}] \approx 0.159 \cdot \frac{V [\text{m}/\text{min}]}{N_M [\text{min}^{-1}] / \eta_G} \cdot F [\text{kgf}]$

(4) Acceleration torque

[Driving mode]

- $\tau [\text{N} \cdot \text{m}] \approx \frac{J [\text{kg} \cdot \text{m}^2]}{9.55} \cdot \frac{\Delta N [\text{min}^{-1}]}{\Delta t [\text{s}] \cdot \eta_G}$
- $T [\text{kgf} \cdot \text{m}] \approx \frac{GD^2 [\text{kg} \cdot \text{m}^2]}{375} \cdot \frac{\Delta N [\text{min}^{-1}]}{\Delta t [\text{s}] \cdot \eta_G}$

[Braking mode]

- $\tau [\text{N} \cdot \text{m}] \approx \frac{J [\text{kg} \cdot \text{m}^2]}{9.55} \cdot \frac{\Delta N [\text{min}^{-1}] \cdot \eta_G}{\Delta t [\text{s}]}$
- $T [\text{kgf} \cdot \text{m}] \approx \frac{GD^2 [\text{kg} \cdot \text{m}^2]}{375} \cdot \frac{\Delta N [\text{min}^{-1}] \cdot \eta_G}{\Delta t [\text{s}]}$

(5) Acceleration time

- $t_{\text{ACC}} [\text{s}] \approx \frac{J_1 + J_2 / \eta_G [\text{kg} \cdot \text{m}^2]}{\tau_M - \tau_L / \eta_G [\text{N} \cdot \text{m}]} \cdot \frac{\Delta N [\text{min}^{-1}]}{9.55}$
- $t_{\text{ACC}} [\text{s}] \approx \frac{GD_1^2 + GD_2^2 / \eta_G [\text{kg} \cdot \text{m}^2]}{T_M - T_L / \eta_G [\text{kgf} \cdot \text{m}]} \cdot \frac{\Delta N [\text{min}^{-1}]}{375}$

(6) Deceleration time

- $t_{\text{DEC}} [\text{s}] \approx \frac{J_1 + J_2 \cdot \eta_G [\text{kg} \cdot \text{m}^2]}{\tau_M - \tau_L \cdot \eta_G [\text{N} \cdot \text{m}]} \cdot \frac{\Delta N [\text{min}^{-1}]}{9.55}$
- $t_{\text{DEC}} [\text{s}] \approx \frac{GD_1^2 + GD_2^2 \cdot \eta_G [\text{kg} \cdot \text{m}^2]}{T_M - T_L \cdot \eta_G [\text{kgf} \cdot \text{m}]} \cdot \frac{\Delta N [\text{min}^{-1}]}{375}$

Appendix F Allowable Current of Insulated Wires

The tables below list the allowable current of IV wires, HIV wires, and 600 V cross-linked polyethylene insulated wires.

■ IV wire (Maximum allowable temperature: 60°C (140°F))

Table F-1 (a) Allowable Current of Insulated Wires

Wire size (mm ²)	Allowable current Reference value (30°C or less) I ₀ (A)	Wiring in free air					Wiring in wire duct (up to three wires in the same duct)			
		35 °C (I ₀ ×0.91) (A)	40 °C (I ₀ ×0.82) (A)	45 °C (I ₀ ×0.71) (A)	50 °C (I ₀ ×0.58) (A)	55 °C (I ₀ ×0.40) (A)	35 °C (I ₀ ×0.63) (A)	40 °C (I ₀ ×0.57) (A)	45 °C (I ₀ ×0.49) (A)	50 °C (I ₀ ×0.40) (A)
2.0	27	24	22	19	15	11	17	15	13	10
3.5	37	33	30	26	21	15	23	21	18	14
5.5	49	44	40	34	28	20	30	27	24	19
8.0	61	55	50	43	35	25	38	34	29	24
14	88	80	72	62	51	36	55	50	43	35
22	115	104	94	81	66	47	72	65	56	46
38	162	147	132	115	93	66	102	92	79	64
60	217	197	177	154	125	88	136	123	106	86
100	298	271	244	211	172	122	187	169	146	119
150	395	359	323	280	229	161	248	225	193	158
200	469	426	384	332	272	192	295	267	229	187
250	556	505	455	394	322	227	350	316	272	222
325	650	591	533	461	377	266	409	370	318	260
400	745	677	610	528	432	305	469	424	365	298
500	842	766	690	597	488	345	530	479	412	336
2 × 100	497	452	407	352	288	203	313	283	243	198
2 × 150	658	598	539	467	381	269	414	375	322	263
2 × 200	782	711	641	555	453	320	492	445	383	312
2 × 250	927	843	760	658	537	380	584	528	454	370
2 × 325	1083	985	888	768	628	444	682	617	530	433
2 × 400	1242	1130	1018	881	720	509	782	707	608	496
2 × 500	1403	1276	1150	996	813	575	883	799	687	561

■ HIV wire (Maximum allowable temperature: 75°C (167°F))

Table F-1 (b) Allowable Current of Insulated Wires

Wire size (mm ²)	Allowable current Reference value (30°C or less) I ₀ (A)	Wiring in free air					Wiring in wire duct (up to three wires in the same duct)			
		35 °C (I ₀ ×0.91) (A)	40 °C (I ₀ ×0.82) (A)	45 °C (I ₀ ×0.71) (A)	50 °C (I ₀ ×0.58) (A)	55 °C (I ₀ ×0.40) (A)	35 °C (I ₀ ×0.63) (A)	40 °C (I ₀ ×0.57) (A)	45 °C (I ₀ ×0.49) (A)	50 °C (I ₀ ×0.40) (A)
2.0	32	31	29	27	24	22	21	20	18	17
3.5	45	42	39	37	33	30	29	27	25	23
5.5	59	56	52	49	44	40	39	36	34	30
8.0	74	70	65	61	55	50	48	45	42	38
14	107	101	95	88	80	72	70	66	61	55
22	140	132	124	115	104	94	92	86	80	72
38	197	186	174	162	147	132	129	121	113	102
60	264	249	234	217	197	177	173	162	151	136
100	363	342	321	298	271	244	238	223	208	187
150	481	454	426	395	359	323	316	296	276	248
200	572	539	506	469	426	384	375	351	328	295
250	678	639	600	556	505	455	444	417	389	350
325	793	747	702	650	591	533	520	487	455	409
400	908	856	804	745	677	610	596	558	521	469
500	1027	968	909	842	766	690	673	631	589	530
2 × 100	606	571	536	497	452	407	397	372	347	313
2 × 150	802	756	710	658	598	539	526	493	460	414
2 × 200	954	899	844	782	711	641	625	586	547	492
2 × 250	1130	1066	1001	927	843	760	741	695	648	584
2 × 325	1321	1245	1169	1083	985	888	866	812	758	682
2 × 400	1515	1428	1341	1242	1130	1018	993	931	869	782
2 × 500	1711	1613	1515	1403	1276	1150	1122	1052	982	883

■ 600V crosslinkable polyethylene insulated wire (Maximum allowable tempertaure: 90°C (194°F))

Table F-1 (c) Allowable Current of Insulated Wires

Wire size (mm ²)	Allowable current Reference value (30°C or less) I ₀ (A)	Wiring in free air					Wiring in wire duct (up to three wires in the same duct)			
		35 °C (I ₀ ×0.91) (A)	40 °C (I ₀ ×0.82) (A)	45 °C (I ₀ ×0.71) (A)	50 °C (I ₀ ×0.58) (A)	55 °C (I ₀ ×0.40) (A)	35 °C (I ₀ ×0.63) (A)	40 °C (I ₀ ×0.57) (A)	45 °C (I ₀ ×0.49) (A)	50 °C (I ₀ ×0.40) (A)
2.0	38	36	34	32	31	29	25	24	22	21
3.5	52	49	47	45	42	39	34	33	31	29
5.5	69	66	63	59	56	52	46	44	41	39
8.0	86	82	78	74	70	65	57	54	51	48
14	124	118	113	107	101	95	82	79	74	70
22	162	155	148	140	132	124	108	103	97	92
38	228	218	208	197	186	174	152	145	137	129
60	305	292	279	264	249	234	203	195	184	173
100	420	402	384	363	342	321	280	268	253	238
150	556	533	509	481	454	426	371	355	335	316
200	661	633	605	572	539	506	440	422	398	375
250	783	750	717	678	639	600	522	500	472	444
325	916	877	838	793	747	702	611	585	552	520
400	1050	1005	961	908	856	804	700	670	633	596
500	1187	1136	1086	1027	968	909	791	757	715	673
2 × 100	700	670	641	606	571	536	467	447	422	397
2 × 150	927	888	848	802	756	710	618	592	559	526
2 × 200	1102	1055	1008	954	899	844	735	703	664	625
2 × 250	1307	1251	1195	1130	1066	1001	871	834	787	741
2 × 325	1527	1462	1397	1321	1245	1169	1018	974	920	866
2 × 400	1751	1676	1602	1515	1428	1341	1167	1117	1055	993
2 × 500	1978	1894	1809	1711	1613	1515	1318	1262	1192	1122

Appendix G Conformity with Standards

G.1 Compliance with European Standards (CE)

The CE marking on Fuji products indicates that they comply with the essential requirements of the Electromagnetic Compatibility (EMC) Directive 2004/108/EC, Low Voltage Directive 2006/95/EC, and Machinery Directive 2006/42/EC which are issued by the Council of the European Communities.

Table G-1 Conformity with Standards

	Standards
EMC Directives	IEC/EN61800-3 : 2004/A1 : 2012 Immunity : Second environment (Industrial) Emission : Category C2 (Applicable only when an optional EMC-compliant filter is attached) : Type of FRN0012E2E-4□ or below : Category C2 Type of FRN0011E2E-7□ or below : Category C2 Type of FRN0020E2E-4□ or above : Category C3 (Applicable only to the EMC filter built-in type of inverters) IEC/EN61326-3-1 : 2008
Low Voltage Directive	IEC/EN61800-5-1 : 2007

CAUTION

The EMC filter built-in type of the FRENIC-Ace inverters is categorized as “Category C3” of the EN61800-3. It is not designed for use in a domestic environment. It may interfere with the operations of home appliances or office equipment due to noise emitted from it.

[1] Compliance with EMC standards

The CE marking on inverters does not ensure that the entire equipment including our CE-marked products is compliant with the EMC Directive. Therefore, CE marking for the equipment shall be the responsibility of the equipment manufacturer. For this reason, Fuji's CE mark is indicated under the condition that the product shall be used within equipment meeting all requirements for the relevant Directives. Instrumentation of such equipment shall be the responsibility of the equipment manufacturer.

Generally, machinery or equipment includes not only our products but other devices as well. Manufacturers, therefore, shall design the whole system to be compliant with the relevant Directives.

■ List of EMC-compliant filters

To satisfy the requirements noted above, use the EMC filter built-in type inverters or the combination of the basic type of inverters that have no built-in EMC filter and an external filter (option) dedicated to Fuji inverters. In either case, mount inverters in accordance with the installation procedure given below. To ensure the compliance, it is recommended to mount the inverters in a metal panel.



Our EMC compliance test is performed under the following conditions.

Wiring length (of the shielded cable) between the inverter (EMC filter built-in type) and motor: 10m



To use Fuji inverters in combination with a PWM converter, the basic type of inverters having no built-in EMC filter should be used. Use of an EMC filter built-in type may increase heat of capacitors in the inverter, resulting in damage. In addition, the effect of the EMC filter can no longer be expected.

Table G-2 EMC-compliant filter

Power supply voltage	Inverter type	Specification	Filter type
Three-phase 400V	FRN0002E2■-4□	ND/HD/HND/HHD	W62400-T1688-E002 *1)
	FRN0004E2■-4□	ND/HD/HND/HHD	W62400-T1688-E002 *1)
	FRN0006E2■-4□	ND/HD/HND/HHD	W62400-T1688-E002 *1)
	FRN0007E2■-4□	ND/HD/HHD	W62400-T1688-F002 *1)
	FRN0012E2■-4□	ND/HD/HHD	W62400-T1688-F002 *1)
	FRN0022E2■-4□	ND	FS21312-44-07
		HD/HND	FS21559-24-07-01
		HHD	FS21559-24-07-01
	FRN0029E2■-4□	ND	FS21312-44-07
		HD/HND	FS21312-44-07
		HHD	FS21559-24-07-01
	FRN0037E2■-4□	ND	FS5536-72-07 (EFL-22G11-4)
		HD/HND	FS21312-44-07
		HHD	FS21312-44-07
	FRN0044E2■-4□	ND	FS5536-72-07 (EFL-22G11-4)
		HD/HND	FS5536-72-07 (EFL-22G11-4)
		HHD	FS21312-44-07
	FRN0059E2■-4□	ND	FS21312-78-07
		HD/HND	FS5536-72-07 (EFL-22G11-4)
		HHD	FS5536-72-07 (EFL-22G11-4)
	FRN0072E2■-4□	ND	-
		HD/HND	FS21312-78-07
		HHD	FS5536-72-07 (EFL-22G11-4)
	FRN0085E2■-4□	ND	FS5536-180-40
		HD/HND	FS5536-100-35
		HHD	FS5536-100-35
	FRN0105E2■-4□	ND	FS5536-180-40
		HD/HND	FS5536-180-40
		HHD	FS5536-100-35
	FRN0139E2■-4□	ND/HD/HND/HHD	FS5536-180-40
	FRN0168E2■-4□	ND/HD/HND/HHD	FS5536-180-40
	FRN0203E2■-4□	ND	FS5536-250-99-1
		HD/HND/HHD	FS5536-180-40
FRN0240E2■-4□	ND	FS5536-250-99-1	
	HD/HND	FS5536-250-99-1	
	HHD	FS5536-180-40	
FRN0290E2■-4□	ND	FS5536-400-99-1	
	HD/HND	FS5536-250-99-1	
	HHD	FS5536-250-99-1	
FRN0361E2■-4□	ND	FS5536-400-99-1	
	HD/HND	FS5536-400-99-1	
	HHD	FS5536-250-99-1	
FRN0415E2■-4□	ND/HD/HND/HHD	FS5536-400-99-1	
FRN0520E2■-4□	ND/HD/HND/HHD	FS5536-400-99-1	
FRN0590E2■-4□	ND	FN3359-600-99 *2)	
	HD/HND	FN3359-600-99 *2)	
	HHD	FS5536-400-99-1	

*1) A ferrite core is added for input power wires and grounding wire (2 turns), or two ferrite cores are added for input power wires and grounding wire, 1 turns.

*2) IF carrier frequency setting is 4 kHz or less or a zero-phase reactor is added at the input cable, conforms category C2. Except this condition, conforms category C3.

Note: A box (■) in the above table replaces S (Basic type) or E (EMC filter built-in type) depending on the enclosure. A box (□) in the above table replaces GA, GB or C depending on the model.

Power supply voltage	Inverter type	Specification	Filter type
Three-phase 200V	FRN0001E2■-2□	HND/HHD	W62400-T1688-E002
	FRN0002E2■-2□	HND/HHD	W62400-T1688-E002
	FRN0004E2■-2□	HND/HHD	W62400-T1688-E002
	FRN0006E2■-2□	HND/HHD	W62400-T1688-E002
	FRN0010E2■-2□	HND/HHD	W62400-T1688-H005 *3)
	FRN0012E2■-2□	ND/HHD	W62400-T1688-H005 *3)
	FRN0020E2■-2□	ND/HHD	W62400-T1688-H005 *3)
	FRN0030E2■-2□	HND	FS5956-53-52
		HHD	FS5956-53-52
	FRN0040E2■-2□	HND	EFL-15SP-2
		HHD	FS5956-53-52
	FRN0056E2■-2□	HND	EFL-15SP-2
		HHD	EFL-15SP-2
	FRN0069E2■-2□	HND	EFL-15SP-2
		HHD	EFL-15SP-2
	FRN0088E2■-2□	HND	EFL-22SP-2
		HHD	EFL-22SP-2
FRN0115E2■-2□	HND	FS5536-180-40	
	HHD	EFL-22SP-2	
Single-phase 200V	FRN0001E2■-7□	HHD	W62400-T1775-E001
	FRN0002E2■-7□	HHD	W62400-T1775-E001
	FRN0003E2■-7□	HHD	W62400-T1775-E001
	FRN0005E2■-7□	HHD	W62400-T1775-E001
	FRN0008E2■-7□	HHD	W62400-T1775-F001
	FRN0011E2■-7□	HHD	W62400-T1775-F001

*3) A ferrite core is added for input power wires and grounding wire (1 turn).

Note: A box (■) in the above table replaces S (Basic type) or E (EMC filter built-in type) depending on the enclosure.

A box (□) in the above table replaces GA, GB or C depending on the model.

■ Recommended installation procedure

To make the machinery or equipment fully compliant with the EMC Directive, certified technicians should wire the motor and inverter in strict accordance with the procedure described below.

In case an external EMC-compliant filter (option) is used

- (1) Mount the inverter and the filter on a grounded panel or metal plate. Use shielded wires for the motor cable and route the cable as short as possible. Firmly clamp the shields to the metal plate to ground them. Further, connect the shielding layers electrically to the grounding terminal of the motor.
- (2) For connection to inverter's control terminals and for connection of the RS-485 communication signal cable, use shielded wires. As with the motor connections, clamp the shields firmly to a grounded panel.
- (3) If noise from the inverter exceeds the permissible level, enclose the inverter and its peripherals within a metal panel as shown in Figure G-1.

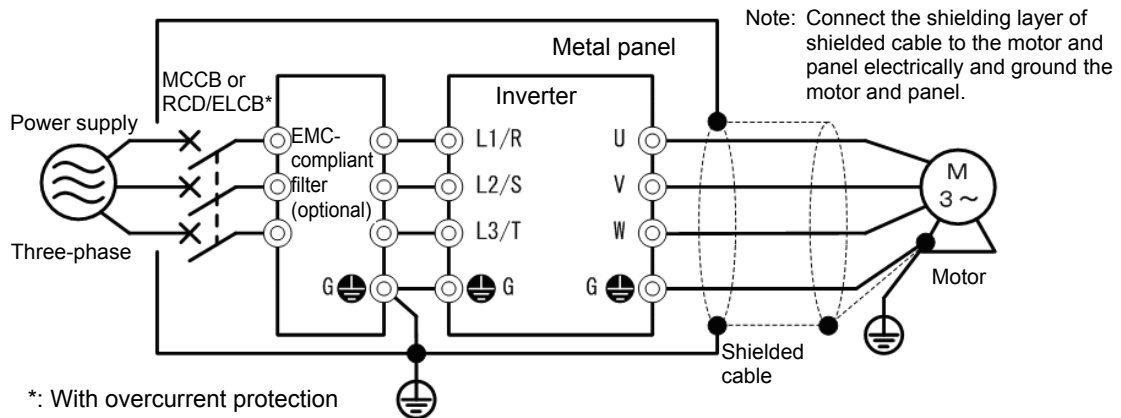

Figure G-1 Mounting an EMC-compliant Filter (option) in a Metal Panel

In case of EMC filter built-in type inverter

- (1) Mount the inverter and the filter on a grounded panel or metal plate. Use shielded wires for the motor cable and route the cable as short as possible. Firmly clamp the shields to the metal plate to ground them. Further, connect the shielding layers electrically to the grounding terminal of the motor.
- (2) For connection to inverter's control terminals and for connection of the RS-485 communication signal cable, use shielded wires. As with the motor connections, clamp the shields firmly to a grounded panel.
- (3) If noise from the inverter exceeds the permissible level, enclose the inverter and its peripherals within a metal panel as shown in Figure G-2.

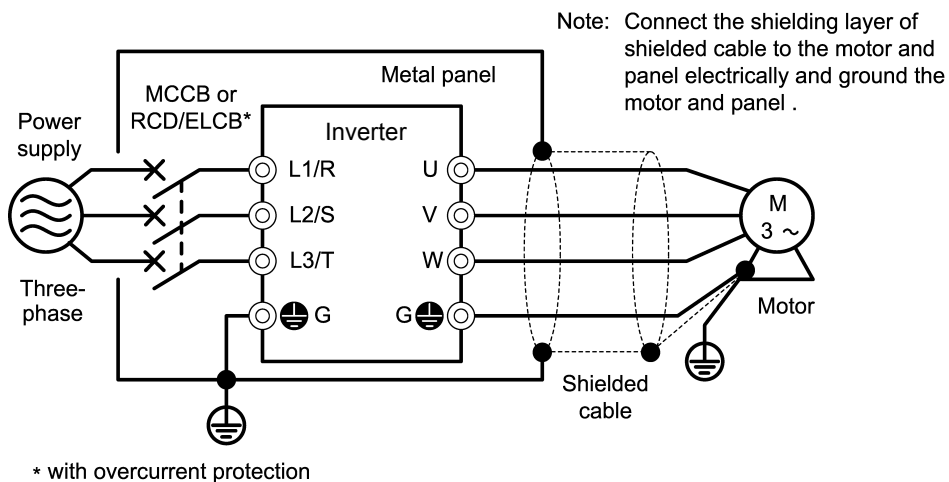

Figure G-2 Mounting the inverter in a Metal Panel

■ Leakage current of EMC-filter built-in type of inverters

An EMC filter uses grounding capacitors for noise suppression which increase leakage current. When using an EMC-filter built-in type of inverters, therefore, check whether there is no problem with electrical systems.

⚠ CAUTION

Three-Phase PDS (Power Drive System) with touch currents ≥ 3.5 mA AC or ≥ 10 mA DC

As the touch current (leakage current) of inverters with EMC-filter is relatively high, it is of essential importance to always assure a reliable connection to Protective Earth (PE).

In Table G-3, for the inverter types whose leakage currents are equal to or exceed the critical value of 3.5 mA AC or 10 mA DC (IEC 61800-5-1), the minimum cross sectional area of the PE-conductor should be:

- 10 mm² (Cu-conductors)
- 16 mm² (Al-conductors)

An electric shock could occur.

Table G-3 Leakage Current of EMC Filter Built-in Type of Inverters

Power supply voltage	Inverter type	Leakage current (mA)
Three-phase 400V *1)	FRN0002E2E-4□	*1
	FRN0004E2E-4□	*1
	FRN0006E2E-4□	*1
	FRN0007E2E-4□	*1
	FRN0012E2E-4□	*1
	FRN0022E2E-4□	*1
	FRN0029E2E-4□	*1
	FRN0037E2E-4□	*1
	FRN0044E2E-4□	*1
	FRN0059E2E-4□	4
	FRN0072E2E-4□	
	FRN0085E2E-4□	11
	FRN0105E2E-4□	
	FRN0139E2E-4□	
	FRN0168E2E-4□	5
	FRN0203E2E-4□	
	FRN0290E2E-4□	
	FRN0361E2E-4□	
	FRN0415E2E-4□	
	FRN0520E2E-4□	
Single-phase 200V *2)	FRN0590E2E-4□	
	FRN0001E2E-7□	*1
	FRN0002E2E-7□	*1
	FRN0004E2E-7□	*1
	FRN0006E2E-7□	*1
	FRN0010E2E-7□	*1
FRN0012E2E-7□	*1	

*1) Calculated based on these measuring conditions: 480 V/ 60 Hz, neutral grounding in Y-connection, interphase voltage unbalance ratio 2%.

*2) Calculated based on these measuring conditions: 240 V/ 60 Hz, one-phase grounding in delta-connection, interphase voltage unbalance ratio 2%.

Note: A box (□) in the above table replaces GA, GB or C depending on the model.

*1 Please contact Fuji Electric about these models.

[2] Compliance with the low voltage directive in the EU

General-purpose inverters are regulated by the Low Voltage Directive in the EU. Fuji Electric states that all our inverters with CE marking are compliant with the Low Voltage Directive.



■ Note

If installed according to the guidelines given below, inverters marked with CE are considered as compliant with the Low Voltage Directive 2006/95/EC.

Compliance with European Standards

Adjustable speed electrical power drive systems.

Part 5-1: Safety requirements. Electrical, thermal and energy. IEC/EN61800-5-1 : 2007

  WARNING				
<p>1. The ground terminal  G should always be connected to the ground. Do not use only a residual-current-operated protective device (RCD)/earth leakage circuit breaker (ELCB)* as the sole method of electric shock protection. Be sure to use ground wires whose size is greater than power supply lines. *With overcurrent protection.</p> <p>2. To prevent the risk of hazardous accidents that could be caused by damage of the inverter, install the specified fuses in the supply side (primary side) according to the following tables. • Breaking capacity: Min. 10 kA • Rated voltage: Min. 500 V</p>				
Power supply voltage	Nominal applied motor (kW)	Inverter type	HHD/HND/HD/ND mode	Fuse rating (A)
Three phase 200V	0.1	FRN0001E2■-2□	HHD	6(IEC60269-2)
	0.2		HND	6(IEC60269-2)
	0.2	FRN0002E2■-2□	HHD	6(IEC60269-2)
	0.4		HND	6(IEC60269-2)
	0.4	FRN0004E2■-2□	HHD	10(IEC60269-2)
	0.75		HND	10(IEC60269-2)
	0.75	FRN0006E2■-2□	HHD	15(IEC60269-2)
	1.5		HND	15(IEC60269-2)
	1.5	FRN0010E2■-2□	HHD	20(IEC60269-2)
	2.2		HND	20(IEC60269-2)
	2.2	FRN0012E2■-2□	HHD	30(IEC60269-2)
	3.0		ND	30(IEC60269-2)
	3.7	FRN0020E2■-2□	HHD	40(IEC60269-2)
	5.5		ND	50(IEC60269-2)
	5.5	FRN0030E2■-2□	HHD	125(IEC60269-4)
	7.5		HND	125(IEC60269-4)
	7.5	FRN0040E2■-2□	HHD	160(IEC60269-4)
	11		HND	160(IEC60269-4)
	11	FRN0056E2■-2□	HHD	160(IEC60269-4)
	15		HND	160(IEC60269-4)
	15	FRN0069E2■-2□	HHD	200(IEC60269-4)
	18.5		HND	200(IEC60269-4)
	18.5	FRN0088E2■-2□	HHD	250(IEC60269-4)
	22		HND	250(IEC60269-4)
22	FRN0115E2■-2□	HHD	350(IEC60269-4)	
30		HND	350(IEC60269-4)	

  **WARNING**

Power supply voltage	Nominal applied motor (kW)	Inverter type	HHD/HND/HD/ND mode	Fuse rating (A)
Three phase 400V	0.4	FRN0002E2■-4□	HHD	3(IEC60269-2)
	0.75		HND/HD	6(IEC60269-2)
	0.75		ND	6(IEC60269-2)
	0.75	FRN0004E2■-4□	HHD	6(IEC60269-2)
	1.1		HND/HD	10(IEC60269-2)
	1.5	FRN0006E2■-4□	ND	10(IEC60269-2)
	1.5		HHD	10(IEC60269-2)
	2.2	FRN0007E2■-4□	HND/HD	15(IEC60269-2)
	2.2		ND	15(IEC60269-2)
	2.2		HHD	15(IEC60269-2)
	3.0	FRN0012E2■-4□	HD	20(IEC60269-2)
	3.0		ND	20(IEC60269-2)
	3.7	FRN0022E2■-4□	HHD	20(IEC60269-2)
	5.5		HD	30(IEC60269-2)
	5.5		ND	30(IEC60269-2)
	5.5	FRN0029E2■-4□	HHD	80(IEC60269-4)
	7.5		HND/HD	80(IEC60269-4)
	11	FRN0037E2■-4□	ND	80(IEC60269-4)
	7.5		HHD	80(IEC60269-4)
	11		HND/HD	80(IEC60269-4)
	15	FRN0044E2■-4□	ND	125(IEC60269-4)
	11		HHD	125(IEC60269-4)
	15	FRN0059E2■-4□	HND/HD	125(IEC60269-4)
	18.5		ND	125(IEC60269-4)
	18.5		HHD	160(IEC60269-4)
	18.5	FRN0072E2■-4□	HND/HD	160(IEC60269-4)
	22		ND	160(IEC60269-4)
	18.5	FRN0085E2■-4□	HHD	160(IEC60269-4)
	22		HND/HD	160(IEC60269-4)
	30		ND	160(IEC60269-4)
	22	FRN0105E2■-4□	HHD	160(IEC60269-4)
	30		HND/HD	160(IEC60269-4)
	37	FRN0139E2■-4□	ND	160(IEC60269-4)
	30		HHD	250(IEC60269-4)
	37		HND/HD	250(IEC60269-4)
	45	FRN0168E2■-4□	ND	250(IEC60269-4)
	37		HHD	315(IEC60269-4)
	45	FRN0203E2■-4□	HND/HD	315(IEC60269-4)
	55		ND	315(IEC60269-4)
	45		HHD	315(IEC60269-4)
	55	FRN0240E2■-4□	HND/HD	315(IEC60269-4)
	75		ND	315(IEC60269-4)
	55	FRN0290E2■-4□	HHD	350(IEC60269-4)
	75		HND/HD	350(IEC60269-4)
	90		ND	350(IEC60269-4)
	90	FRN0361E2■-4□	HHD	350(IEC60269-4)
	90		HND/HD	350(IEC60269-4)
	110	FRN0415E2■-4□	ND	350(IEC60269-4)
	90		HHD	350(IEC60269-4)
	110		HND/HD	350(IEC60269-4)
132	FRN0520E2■-4□	ND	450(IEC60269-4)	
110		HHD	400(IEC60269-4)	
132	FRN0590E2■-4□	HND/HD	400(IEC60269-4)	
160		ND	500(IEC60269-4)	
132		HHD	450(IEC60269-4)	
160	FRN0520E2■-4□	HND/HD	450(IEC60269-4)	
200		ND	550(IEC60269-4)	
160	FRN0590E2■-4□	HHD	500(IEC60269-4)	
200		HND/HD	500(IEC60269-4)	
220		ND	630(IEC60269-4)	
200	FRN0520E2■-4□	HHD	550(IEC60269-4)	
220		HND/HD	550(IEC60269-4)	
280	FRN0590E2■-4□	ND	900(IEC60269-4)	
220		HHD	630(IEC60269-4)	
280		HND	630(IEC60269-4)	
250		HD	630(IEC60269-4)	
315			ND	900(IEC60269-4)

Note: A box (■) in the above table replaces S (Basic type) or E (EMC filter built-in type) depending on the enclosure.
 A box (□) in the above table replaces GA, GB or C depending on the model.

⚠ ⚠ WARNING

Power supply voltage	Nominal applied motor (kW)	Inverter type	HHD/HND/HD/ND mode	Fuse rating (A)
Three phase 400V	90	FRN0240E2■-4□	HHD	350(IEC60269-4)
	110		HND/HD	350(IEC60269-4)
	132		ND	450(IEC60269-4)
	110	FRN0290E2■-4□	HHD	400(IEC60269-4)
	132		HND/HD	400(IEC60269-4)
	160		ND	500(IEC60269-4)
	132	FRN0361E2■-4□	HHD	450(IEC60269-4)
	160		HND/HD	450(IEC60269-4)
	200		ND	550(IEC60269-4)
	160	FRN0415E2■-4□	HHD	500(IEC60269-4)
	200		HND/HD	500(IEC60269-4)
	220		ND	630(IEC60269-4)
	200	FRN0520E2■-4□	HHD	550(IEC60269-4)
	220		HND/HD	550(IEC60269-4)
	280		ND	900(IEC60269-4)
	220	FRN0590E2■-4□	HHD	630(IEC60269-4)
	280		HND	630(IEC60269-4)
	250		HD	630(IEC60269-4)
315	ND		900(IEC60269-4)	
Single phase 200V	0.1	FRN0001E2■-7□	HHD	6(IEC60269-2)
	0.2	FRN0002E2■-7□	HHD	6(IEC60269-2)
	0.4	FRN0003E2■-7□	HHD	10(IEC60269-2)
	0.75	FRN0005E2■-7□	HHD	20(IEC60269-2)
	1.5	FRN0008E2■-7□	HHD	30(IEC60269-2)
	2.2	FRN0011E2■-7□	HHD	50(IEC60269-2)

Note: A box (■) in the above table replaces S (Basic type) or E (EMC filter built-in type) depending on the enclosure.

A box (□) in the above table replaces GA, GB or C depending on the model.

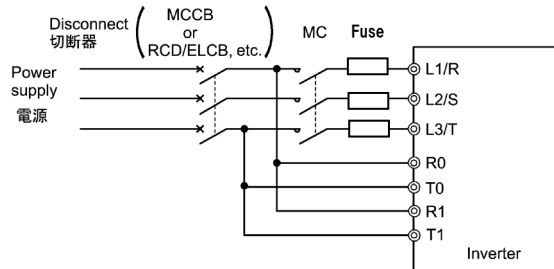

Compliance with the low voltage directive in the EU (Continued)



3. When used with the inverter, a molded case circuit breaker (MCCB), residual-current-operated protective device (RCD)/earth leakage circuit breaker (ELCB) or magnetic contactor (MC) should conform to the EN or IEC standards.
4. When you use a residual-current-operated protective device (RCD)/earth leakage circuit breaker (ELCB) for protection from electric shock in direct or indirect contact power lines or nodes, be sure to install type B of RCD/ELCB on the input (primary) of the inverter.

Power supply voltage	Nominal applied motor (kW)	Inverter type	ND/HD/HND mode	MCCB or RCD/ELCB *1 Rated current	
				W/DCR	W/o DCR
Three-phase 200 V	0.1	FRN0001E2■-2□	HHD	5	5
	0.2		HND	5	5
	0.2	FRN0002E2■-2□	HHD	5	5
	0.4		HND	5	5
	0.4	FRN0004E2■-2□	HHD	5	5
	0.75		HND	5	10
	0.75	FRN0006E2■-2□	HHD	5	10
	1.1		HND	10	10
	1.5	FRN0010E2■-2□	HHD	10	15
	2.2		HND	10	20
	2.2	FRN0012E2■-2□	HHD	10	20
	3.0		ND	20	30
	3.7	FRN0020E2■-2□	HHD	20	30
	5.5		ND	30	40
	5.5	FRN0030E2■-2□	HHD	30	50
	7.5		HND	40	75
	7.5	FRN0040E2■-2□	HHD	40	75
	11		HND	50	100
	11	FRN0056E2■-2□	HHD	50	100
	15		HND	75	125
	15	FRN0069E2■-2□	HHD	75	125
	18.5		HND	100	150
18.5	FRN0088E2■-2□	HHD	100	150	
22		HND	100	175	
22	FRN0115E2■-2□	HHD	100	175	
30		HND	150	200	
Three-phase 400 V	0.4	FRN0002E2■-4□	HHD	5	5
	0.75		HND	5	5
	0.75		HD	5	5
	0.75		ND	5	5
	1.5	FRN0004E2■-4□	HHD	5	5
	1.1		HND	5	5
	1.1		HD	5	5
	0.75		ND	5	5
	1.5	FRN0006E2■-4□	HHD	5	10
	2.2		HND	5	10
	2.2		HD	5	10
	2.2		ND	5	10
	2.2	FRN0007E2■-4□	HHD	10	15
	-		-	-	-
	3.0		HD	10	15
	3.0		ND	10	15
	3.7	FRN0012E2■-4□	HHD	10	20
	-		-	-	-
	5.5		HD	15	30
	5.5		ND	15	30

Note: A box (■) in the above table replaces S (Basic type) or E (EMC filter built-in type) depending on the enclosure.
 A box (□) in the above table replaces GA, GB or C depending on the model.

⚠ WARNING ⚠

Power supply voltage	Nominal applied motor (kW)	Inverter type	ND/HD/HND mode	MCCB or RCD/ELCB *1 Rated current	
				W/DCR	W/o DCR
Three-phase 400 V	5.5	FRN0022E2■-4□	HHD	15	30
	7.5		HND	20	40
	7.5		HD		
	11		ND	30	50
	7.5	FRN0029E2■-4□	HHD	20	40
	11		HND	30	50
	11		HD		
	15		ND	40	60
	11	FRN0037E2■-4□	HHD	30	50
	15		HND	40	60
	15		HD		
	18.5		ND	40	75
	15	FRN0044E2■-4□	HHD	40	60
	18.5		HND	40	75
	18.5		HD		
	22		ND	50	100
	18.5	FRN0059E2■-4□	HHD	40	75
	22		HND	50	100
	22		HD		
	30		ND	75	125
	22	FRN0072E2■-4□	HHD	50	100
	30		HND	75	125
	30		HD		
	37		ND	100	—
	30	FRN0085E2■-4□	HHD	75	125
	37		HND	100	150
	37		HD		
	45		ND	100	125
	37	FRN0105E2■-4□	HHD	100	150
	45		HND	100	200
	45		HD		
	55		ND	125	200
	45	FRN0139E2■-4□	HHD	100	150
	55		HND	125	200
	55		HD		
	75		ND	175	—
	55	FRN0168E2■-4□	HHD	125	200
	75		HND	175	—
	75		HD		
	90		ND	200	—
	75	FRN0203E2■-4□	HHD	175	—
	90		HND	200	—
90	HD				
110	ND		250	—	
90	FRN0240E2■-4□	HHD	250	—	
110		HND	250	—	
110		HD			
132		ND	300	—	
110	FRN0290E2■-4□	HHD	250	—	
132		HND	300	—	
132		HD			
160		ND	350	—	
132	FRN0361E2■-4□	HHD	300	—	
160		HND	350	—	
160		HD			
200		ND	500	—	
160	FRN0415E2■-4□	HHD	350	—	
200		HND	500	—	
200		HD			
220		ND	500	—	
200	FRN0520E2■-4□	HHD	500	—	
220		HND	500	—	
220		HD			
280		ND	600	—	
220	FRN0590E2■-4□	HHD	500	—	
280		HND	600	—	
250		HD			
315		ND	800	—	

Note: A box (■) in the above table replaces S (Basic type) or E (EMC filter built-in type) depending on the enclosure.

A box (□) in the above table replaces GA, GB or C depending on the model.

*1 The frame size and model of the MCCB or RCD/ELCB (with overcurrent protection) will vary, depending on the power transformer capacity. Refer to the related technical documentation for details.

⚠ WARNING ⚠

Power supply voltage	Nominal applied motor (kW)	Inverter type	ND/HD/HND mode	MCCB or RCD/ELCB *1 Rated current	
				W/DCR	W/o DCR
Single-phase 200 V	0.1	FRN0001E2■-7□	HHD	5	5
	0.2	FRN0002E2■-7□	HHD	5	5
	0.4	FRN0003E2■-7□	HHD	5	10
	0.75	FRN0005E2■-7□	HHD	10	15
	1.5	FRN0008E2■-7□	HHD	15	20
	2.2	FRN0011E2■-7□	HHD	20	30

Note: A box (■) in the above table replaces S (Basic type) or E (EMC filter built-in type) depending on the enclosure.

A box (□) in the above table replaces GA, GB or C depending on the model.

*1 The frame size and model of the MCCB or RCD/ELCB (with overcurrent protection) will vary, depending on the power transformer capacity. Refer to the related technical documentation for details.

5. The inverter should be used in an environment that does not exceed Pollution Degree 2 requirements. If the environment has a Pollution Degree 3 or 4, install the inverter in an enclosure of IP54 or higher.
6. Install the inverter, AC or DC reactor, input or output filter in an enclosure with minimum degree of protection of IP2X (Top surface of enclosure shall be minimum IP4X when it can be easily accessed), to prevent human body from touching directly to live parts of these equipment.
7. Do not connect any copper wire directly to grounding terminals. Use crimp terminals with tin or equivalent plating to connect them.
8. When you use an inverter at an altitude of more than 2000 m, you should apply basic insulation for the control circuits of the inverter. The inverter cannot be used at altitudes of more than 3000 m.
9. Use wires described in Chapter 2 “2.2.5 [1] Screw specifications” and “2.2.5 [3] Recommended wire size (main circuit terminals).”

⚠ WARNING ⚠

10. Use this inverter at the following power supply system.

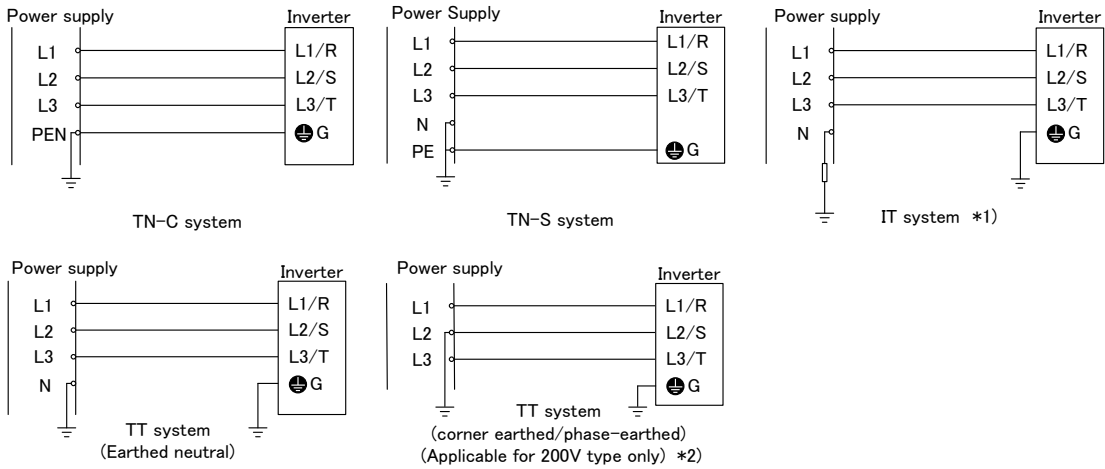

*1 Use this inverter at the following IT system.

Non-earthed (isolated from earth) IT system	Can be used. In this case the insulation between the control interface and the main circuit of the inverter is basic insulation. Thus do not connect SELV circuit from external controller directly (make connection using a supplementary insulation). Use an earth fault detector able to disconnect the power within 5s after the earth fault occurs.
IT system which earthed neutral by an impedance	
Corner earthed / Phase-earthed IT system by an impedance	Can not be used

*2 Cannot apply to Corner earthed / Phase-earthed TT system of 400V type

G.2 Harmonic Component Regulation in the EU

[1] General comments

When you use general-purpose industrial inverters in the EU, the harmonics emitted from the inverter to power lines are strictly regulated as stated below.

If an inverter whose rated input is 1 kW or less is connected to public low-voltage power supply, it is regulated by the harmonics emission regulations from inverters to power lines (with the exception of industrial low-voltage power lines). Refer to Figure G-3 Power Source and Regulation below for details.

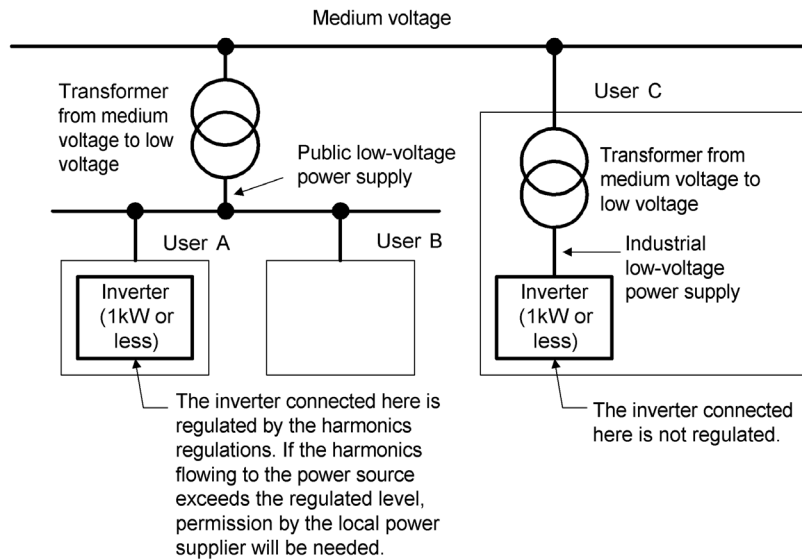

Figure G-3 Power Source and Regulation

[2] Compliance with the harmonic component regulation

Table G-4 Compliance with Harmonic Component Regulation

Power supply voltage	Inverter type	Nominal applied motor(kW)	ND/HD/HND/HHD	w/o DC reactor	w/ DC reactor	Applicable DC reactor type
Three-phase 200 V	FRN0001E2■-2□	0.1	HHD	√*	√*	DCR2-0.2
		0.2	HND	√*	√*	DCR2-0.2
	FRN0002E2■-2□	0.2	HHD	√*	√*	DCR2-0.2
		0.4	HND	√*	√*	DCR2-0.4
	FRN0004E2■-2□	0.4	HHD	√*	√*	DCR2-0.4
		0.75	HND	√*	√*	DCR2-0.75
FRN0006E2■-2□	0.75	HHD	√*	√*	DCR2-0.75	
Three-phase 400 V	FRN0002E2■-4□	0.4	HHD	—	√	DCR4-0.4
		0.75	HND	—	√	DCR4-0.75
	FRN0004E2■-4□	0.75	HHD	—	√	DCR4-0.75
Single-phase 200 V	FRN0001E2■-7□	0.1	HHD	—	√	DCR2-0.2
	FRN0002E2■-7□	0.2	HHD	—	√	DCR2-0.4
	FRN0003E2■-7□	0.4	HHD	—	√	DCR2-0.75
	FRN0005E2■-7□	0.75	HHD	—	—	DCR2-1.5

* Evaluated by the level of harmonics flow to the 400 VAC line when three-phase 200 VAC power is supplied from the three-phase 400 VAC power via a step-down transformer.

G.3 Compliance with UL Standards and Canadian Standards (cUL certification)



Originally, the UL standards were established by Underwriters Laboratories, Inc. as private criteria for inspections/investigations pertaining to fire/accident insurance in the USA. Later, these standards were authorized as the official standards to protect operators, service personnel and the general populace from fires and other accidents in the USA.

cUL certification means that UL has given certification for products to clear CSA Standards. cUL certified products are equivalent to those compliant with CSA Standards.

■ **Notes**

UL/cUL-listed inverters are subject to the regulations set forth by the UL standards and CSA standards (cUL-listed for Canada) by installation within precautions listed below.

⚠ CAUTION

Integral solid state short circuit protection does not provide branch circuit protection. Branch circuit protection must be provided in accordance with the National Electrical Code and any additional local codes.

1. Solid state motor overload protection (motor protection by electronic thermal overload relay) is provided in each model.

Use function codes F10 to F12 to set the protection level, refer to the description below.

F10	Electronic thermal overload protection for motor 1 (Select motor characteristics)	1: Enable (For a general-purpose motor with self-cooling fan) 2: Enable (For an inverter-driven motor with separately powered cooling fan)
F11	(Overload detection level)	0.00 (disable), current value of 1 to 135% of inverter rated current (Inverter rated current dependent on F80)
F12	(Thermal time constant)	0.5 to 75.0 min, Refer to the graph below.

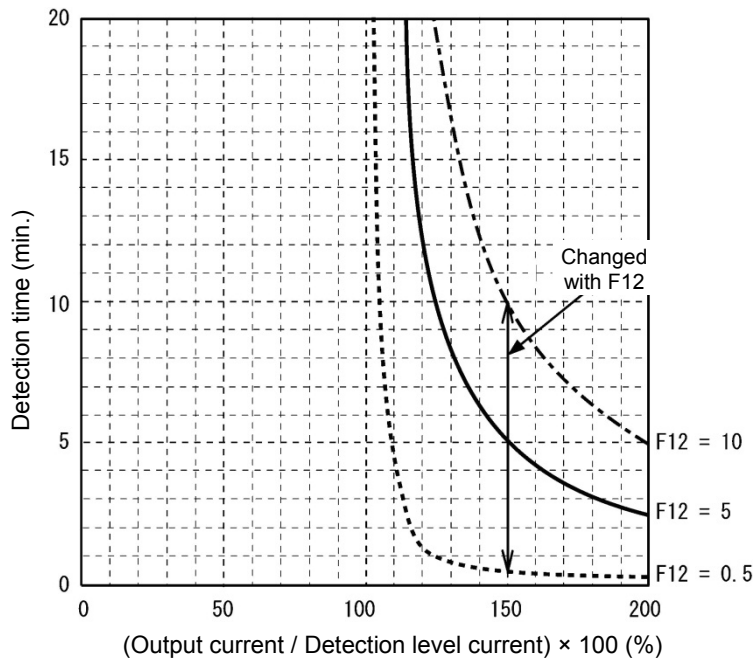

⚠ CAUTION

2. Use Cu wire only.
3. Use Class 1 wire only for control circuits.
4. Short circuit rating
 - For Models FRN0001 to 0006E2■-2□, FRN0088 to 0115E2■-2□ and FRN0001 to 0005E2■-7□:
 "Suitable For Use On A Circuit Of Delivering Not More Than 100,000 rms Symmetrical Amperes, 240 Volts Maximum when Protected by a Class J or Class CC Fuses or a Circuit Breaker Having An Interrupting Rating Not Less Than 100,000 rms Symmetrical Amperes, 240 Volts minimum."
 - For Models FRN0010 to 0069E2■-2□ and FRN0008 to 0011E2■-7□:
 "Suitable For Use On A Circuit Of Delivering Not More Than 100,000 rms Symmetrical Amperes, 240 Volts Maximum when protected by Class J or Class CC Fuses.". May be provided on the instruction manual.
 - For Models FRN0002 to 0044E2■-4□:
 "Suitable For Use On A Circuit Of Delivering Not More Than 100,000 rms Symmetrical Amperes, 480 Volts Maximum when protected by Class J or Class CC Fuses."
 - For Models FRN0059E2■-4□ or above:
 "Suitable For Use On A Circuit Of Delivering Not More Than 100,000 rms Symmetrical Amperes, 480 Volts Maximum when protected by Class J or Class CC Fuses or a Circuit Breaker Having An Interrupting Rating Not Less Than 100,000 rms Symmetrical Amperes, 480 Volts minimum."
5. Field wiring connections must be made by a UL Listed and CSA Certified closed-loop terminal connector sized for the wire gauge involved. Connector must be fixed using the crimp tool specified by the connector manufacturer.
6. All circuits with terminals L1/R, L2/S, L3/T, L1/L, L2/N, R0, T0, R1, T1 must have a common disconnect and be connected to the same pole of the disconnect if the terminals are connected to the power supply.

Connection diagram of the three phase input type.

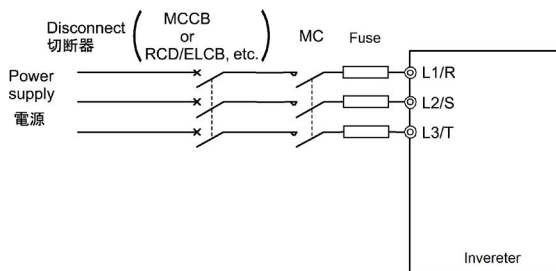

FRN0020E2■-2□ or below
FRN0012E2■-4□ or below

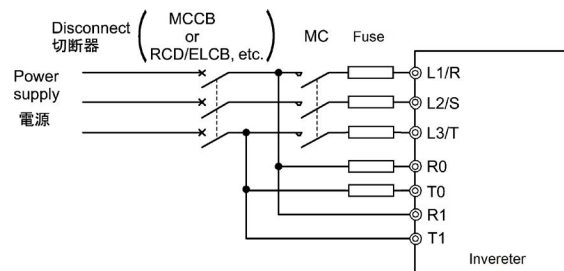

FRN0030E2■-2□ or above
FRN0022E2■-4□ or above

Connection diagram of the single phase input type.

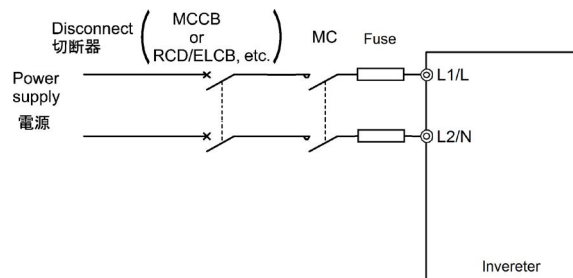

FRN0011E2■-7□ or below

⚠ CAUTION

7. Environmental Requirements

7.1 Type FRN0030E2■-2□/FRN0022E2■-4□ or above

- Maximum Surrounding Air Temperature / Maximum ambient temperature
The ambient temperature shall be lower than the values in the table below.

Enclosure Type	ND/HD	HND/HHD
Open Type	40 deg C	50 deg C
Enclosed Type	40 deg C	40 deg C

- Atmosphere
For use in pollution degree 2 environments (for Open-Type models).

7.2 Type FRN0020E2■-2□/FRN0012E2■-4□/ FRN0011E2■-7□ or below

- Maximum Surrounding Air Temperature
The surrounding air temperature shall be lower than the values in the table below.

Enclosure Type	ND/HD	HND/HHD
Open Type FRN0010E2■-2□ or below FRN0006E2■-4□ or below FRN0011E2■-7□ or below	40 deg C	50 deg C
Open Type FRN0012E2■-2□ FRN0020E2■-2□ FRN0007E2■-4□ FRN0012E2■-4□	40 deg C	50 deg C (HHD) 40 deg C (HND)

- Atmosphere
For use in pollution degree 2 environments (for Open-Type models).

8. UL Enclosure Type

UL Enclosed Type formats are shown in the table below.

Variation	Enclosed Type1
Standard	FRN0030 to 0115E2U-2□ FRN0022 to 0590E2U-4□
EMC Filter	FRN0030 to 0115E2F-2□ FRN0022 to 0590E2F-4□

The other models of above table are excluded.

9. Plenum rated drives

UL Enclosed Type is Suitable for installation in a compartment handling conditioned air. Models of FRN0020E2■-2□/FRN0012E2■-4□/FRN0011E2■-7□ or below are excluded.

10. Functional Description of Control Circuit Terminals

A power source for connection to the Integrated alarm output (30A, 30B, 30C) should be limited to overvoltage category II such as control circuit or secondary winding of power transformer.

Classification	Terminal Symbol	Terminal Name	Functional description
Contact output	[30A/B/C]	Integrated alarm output	When the inverter stops with an alarm, output is generated on the relay contact (1C). Contact capacitance: AC250 V 0.3A cosφ=1, DC30 V 0.5 A

⚠ CAUTION

Power supply voltage	Nominal applied motor(kW)[HP]	Inverter type	HHD/HND/ND mode	Class J or Class CC fuse size (A) *4	Circuit breaker trip size (A) *5	Required torque lb-in (N · m)				Wire size AWG (mm ²)								
						Main terminal	Inverter's grounding	Aux. control power supply	Aux. Fan power supply	Main terminal Cu Wire					Inverter's grounding	Aux. control power supply	Aux. fan power supply	
										L1/R,L2/S,L3/T			U, V, W					Ⓜ G
										60°C Cu wire	75°C Cu wire	Remarks	60°C Cu wire	75°C Cu wire				
Three-phase 400V	5.5 [7.5]	FRN0022E2E-4□	HHD	30	input 15.9 (1.8) other 27 (3.0)	27 (3.0)	-	-	-	12 (3.3)	-	-	14 (2.1)	10 (5.3)	-	-		
	7.5 [10]	FRN0022E2E-4□	HND	40						10 (5.3)			12 (3.3)					
		FRN0029E2E-4□	HHD	60	10 (5.3)	10 (5.3)												
	11 [15]	FRN0029E2E-4□	HND		70	input 15.9 (1.8) other 51.3 (5.8)	51.3 (5.8)	-	-	-	8 (8.4)	-	-	8 (8.4)	8 (8.4)	-	-	
		FRN0037E2E-4□	HHD	10 (5.3)							10 (5.3)							
	15 [20]	FRN0037E2E-4□	HND	90	input 15.9 (1.8) other 51.3 (5.8)	51.3 (5.8)	-	-	-	8 (8.4)	-	-	8 (8.4)	8 (8.4)	-	-		
FRN0044E2E-4□		HHD	6 (13.3)							6 (13.3)								
18.5 [25]	FRN0044E2E-4□	HND																
Single-phase 200V	0.1 [1/8]	FRN0001E2■-7□	HHD	6	7.1 (0.8)	10.6 (1.2)	-	-	-	14 (2.1)	-	-	14 (2.1)	-	-	-		
	0.2 [1/4]	FRN0002E2■-7□	HHD	6													5	
	0.4 [1/2]	FRN0003E2■-7□	HHD	10													10	
	0.75 [1]	FRN0005E2■-7□	HHD	20	15	12 (3.3)	10 (5.3)											
	1.5 [2]	FRN0008E2■-7□	HHD	30	10.6 (1.2)			15.9 (1.8)										
	2.2 [3]	FRN0011E2■-7□	HHD	50														

Note: Control circuit terminals M2 tightening torque: 1.7 lb-in (0.19 N·m) ±10%
 Recommended wire size: AWG26 to 18 (0.14 to 1 mm²)
 M3 tightening torque: 4.4 to 5.3 lb-in (0.5 to 0.6 N·m), recommended wire size: AWG26 to 16 (0.14 to 1.5 mm²)

Note: A box (■) in the above table replaces S (Basic type) or E (EMC filter built-in type) depending on the enclosure.
 A box (□) in the above table replaces GA, GB or C depending on the model.

- *1 No terminal end treatment is required for connection.
- *2 Use 75°C (167°F) Cu wire only.
- *3 The wire size of UL Open Type and Enclosed Type are common. Please contact us if UL Open Type exclusive wire is necessary.
- *4 6 rms Amperes for aux. control power supply. There is no aux. control power supply in FRN0020E2■-2□ /FRN0022E2■-4□/FRN0011E2■-7□ or below.
- *5 5 rms Amperes for aux. control power supply. There is no aux. control power supply in FRN0020E2■-2□ /FRN0022E2■-4□/FRN0011E2■-7□ or below.

G.4 Compliance with the Radio Waves Act (South Korea) (㉸)

한국 전파법 대응

본제품은 한국전파법에 적합한 제품입니다.

한국에서 사용시는 아래에 주의하여 주시기 바랍니다.

“이 기기는 업무용(A 급) 전자파 적합기기로서 판매자 또는 사용자는 이점을 주의하시기 바라며, 가정외의 지역에서 사용하는 것을 목적으로 합니다. 해당제품은 형식 FRN△△△E2■-□GA/GB 의 제품만 대상이 됩니다. (△는 인버터용량, □는 전압시리즈를 표시하는 숫자 2 또는 4 가 표기됩니다.)

Compliance with the Radio Waves Act (South Korea)

This product complies with the Radio Waves Act (South Korea)

Note the following when using the product in South Korea

(The product is for business-use (Class A) and meets the electromagnetic compatibility requirement. The seller and the user must note the above point, and use the product in a place except for home.)

Only the following type of the products is applicable to this certification.

Type: FRN△△△E2■-□GA/GB

(△: indicates inverter output power and □: indicates if the power supply voltage 2 or 4 is.)

High Performance Inverter

FRENIC-Ace

User's Manual

First Edition, February 2013

Fifth Edition, October 2014

Fuji Electric Co., Ltd.

The purpose of this User's manual is to provide accurate information on handling, setting up and operation of the FRENIC-Ace series of inverters. Please feel free to send your comments regarding any errors or omissions you may have found, or any suggestions you may have for generally improving this manual.

In no event will Fuji Electric Co., Ltd. be liable for any direct or indirect damages resulting from the application of the information in this manual.

Fuji Electric Co., Ltd.
